



SEDAR  
Southeast Data, Assessment, and Review

---

SEDAR 74  
Stock Assessment Report

Gulf of Mexico Red Snapper

**January 2024**

SEDAR  
4055 Faber Place Drive, Suite 201  
North Charleston, SC 29405

## Table of Contents

Section I. Introduction	PDF page	3
Section II. Stock Identification Process	PDF page	40
Section III. Data Workshop Report	PDF page	127
Section IV. Assessment Workshop Report	PDF page	352
Section V. Research Recommendations	PDF page	700
Section VI. Review Workshop Report	PDF page	712

# SEDAR



Southeast Data, Assessment, and Review

---

SEDAR 74

Gulf of Mexico Red Snapper

SECTION I: Introduction

SEDAR  
4055 Faber Place Drive, Suite 201  
North Charleston, SC 29405

## Introduction

SEDAR 74 addressed the stock assessment for Gulf of Mexico Red Snapper. The process consisted of a Stock ID Process, conducted via webinars, and in-person Data Workshop, a series of assessment webinars, and an in-person Review Workshop.

The Stock Assessment Report is organized into 6 sections. Section I – Introduction contains a brief description of the SEDAR Process, Assessment and Management Histories for the species of interest, and the management specifications requested by the Cooperator. The results of the Stock Identification Process are presented in Section II. The Data Workshop Report can be found in Section III. It documents the discussions and data recommendations from the Data Workshop Panel. Section IV is the Assessment Process report. This section details the assessment model, as well as documents any changes to the data recommendations that may have occurred after the data workshop. Consolidated Research Recommendations from all stages of the process can be found in Section V for easy reference. Finally, Section VI documents the discussions and findings of the Review Workshop (RW).

The final Stock Assessment Report (SAR) for Gulf of Mexico red snapper was disseminated to the public in January 2024. The Gulf of Mexico Fishery Management Council’s Scientific and Statistical Committee (SSC) will review the SAR. The SSC is tasked with recommending whether the assessments represent Best Available Science, whether the results presented in the SARs are useful for providing management advice and developing fishing level recommendations for the Council. An SSC may request additional analyses be conducted or may use the information provided in the SAR as the basis for their Fishing Level Recommendations (e.g., Overfishing Limit and Acceptable Biological Catch). A review of the assessment will be conducted by the Gulf of Mexico Fishery Management Council’s SSC in February 2024, followed by the Council receiving that information at its April 2024.

### 1 SEDAR PROCESS DESCRIPTION

SouthEast Data, Assessment, and Review (**SEDAR**) is a cooperative Fishery Management Council process initiated in 2002 to improve the quality and reliability of fishery stock assessments in the South Atlantic, Gulf of Mexico, and US Caribbean. SEDAR seeks improvements in the scientific quality of stock assessments and the relevance of information available to address fishery management issues. SEDAR emphasizes constituent and stakeholder participation in assessment development, transparency in the assessment process, and a rigorous and independent scientific review of completed stock assessments.

SEDAR is managed by the Caribbean, Gulf of Mexico, and South Atlantic Regional Fishery Management Councils in coordination with NOAA Fisheries and the Atlantic and Gulf States Marine Fisheries Commissions. Oversight is provided by a Steering Committee composed of NOAA Fisheries representatives: Southeast Fisheries Science Center Director and the Southeast Regional Administrator; Regional Council representatives: Executive Directors and Chairs of the South Atlantic, Gulf of Mexico, and Caribbean Fishery Management Councils; a representative from the Highly Migratory Species Division of NOAA Fisheries, and Interstate Commission representatives: Executive Directors of the Atlantic States and Gulf States Marine Fisheries Commissions.

SEDAR is normally organized around two workshops and a series of webinars. First is the Data Workshop, during which fisheries, monitoring, and life history data are reviewed and compiled. The second stage is the Assessment Process, which is conducted via a workshop and/or a series of webinars, during



which assessment models are developed and population parameters are estimated using the information provided from the Data Workshop. The final step is the Review Workshop, during which independent experts review the input data, assessment methods, and assessment products. The completed assessment, including the reports of all 3 stages and all supporting documentation, is then forwarded to the Council SSC for certification as ‘appropriate for management’ and development of specific management recommendations.

SEDAR workshops are public meetings organized by SEDAR staff and the lead Cooperator. Workshop participants are drawn from state and federal agencies, non-government organizations, Council members, Council advisors, and the fishing industry with a goal of including a broad range of disciplines and perspectives. All participants are expected to contribute to the process by preparing working papers, contributing, providing assessment analyses, and completing the workshop report.

## 2 RED SNAPPER MANAGEMENT OVERVIEW

### 2.1. Fishery Management Plan and Amendments

*Original GMFMC FMP:*

The Reef Fish Fishery Management Plan was implemented in November 1984. The regulations, designed to rebuild declining reef fish stocks, included: (1) prohibitions on the use of poisons or explosives to fish for reef fish; (2) prohibitions on the use of fish traps, roller trawls, and powerhead-equipped spear guns within an inshore stressed area; (3) a minimum size limit of 12 inches fork length for red snapper with the exceptions that headboats were exempted until 1987, each angler could keep 5 undersize fish, and vessels fishing with trawls were exempt from the minimum size limit; and, (4) data reporting requirements.

*GMFMC FMP Amendments affecting red snapper fisheries and harvest:*

Description of Action	FMP/Amendment	Effective Date
Set a red snapper 13-inch total length (TL) minimum size limit, 7-fish recreational bag limit with a 2 bag limit allowance for qualified for-hire vessels out over 24 hours, and 3.1 million-pound commercial quota. Future allocations to be based on the 1979-1987 historical catch ratio of 51% commercial, 49% recreational. Prohibit the sale of undersized red snapper and delete the allowance to keep 5 undersized red snapper; established a framework procedure for specification of total allowable catch (TAC); established commercial reef fish vessel permit; set overfished threshold and optimum yield (OY) biomass level at 20 percent spawning stock biomass per recruit (SSBR), and established a goal to rebuild overfished stocks to above this level by January 1, 2000.	Amendment 1	1990
Replaced 20 percent SSBR target with 20 percent spawning potential ratio (SPR), and changed the target date for rebuilding red snapper to January 1, 2007.	Amendment 3	1991

Established a moratorium on the issuance of new reef fish permits for a maximum period of three years; established an allowance for permit transfers.	Amendment 4	1992
Continued a red snapper endorsement system that had been created via emergency rule through 2004; commercial reef fish vessels with a red snapper endorsement were allowed a 2,000 pound trip limit, and other commercial reef fish vessels were limited to a 200 pound trip. Require all permitted reef fish vessels to abide by trip limits regardless of where the red snapper were caught; allowed the trip limits to be changed under the framework procedure for specification of TAC.	Amendment 6	1993
Incrementally raised size limit from 13" to 16" TL over 5 years, created an Alabama special management zone (SMZ) and a framework procedure for future specification of SMZs. Required that finfish be landed head and tails intact.	Amendment 5	1994
Established reef fish dealer permitting and record keeping.	Amendment 7	1994
Extended the reef fish permit moratorium and red snapper endorsement system through December 31, 1995 and allowed collections of commercial landings data for initial allocation of individual transferable quota (ITQ) shares. Established historical captain status for purposes of ITQ allocation.	Amendment 9	1994
Attempted to establish an ITQ system, which was then repealed by Congress.	Amendment 8	1995
Implemented a new commercial reef fish permit moratorium for no more than five years or until December 31, 2000, permitted dealers can only buy reef fish from permitted vessels and permitted vessels can only sell to permitted dealers, established a charter and headboat reef fish permit, and changed the target date for rebuilding red snapper to January 2009.	Amendment 11	1996
Extended the red snapper endorsement system through the remainder of 1996 and, if necessary, through 1997.	Amendment 13	1996
NMFS disapproved proposed provisions that would have reduced the commercial red snapper minimum size limit from 15" to 14" TL and eliminated a scheduled increase in the commercial size limit to 16" in 1998.	Amendment 12	1997
Initiated a 10-year phase-out on the use of fish traps in the EEZ from February 7, 1997 to February 7, 2007, after which fish traps would be prohibited.	Amendment 14	1997

Prohibited harvest of reef fish from traps other than permitted reef fish traps, stone crab traps, or spiny lobster traps. Established 2-tier red snapper license system (Class 1 & 2). Comm. season split, with 2/3 of quota allocated for Feb 1 opening and remaining quota for Sept 1 opening.	Amendment 15	1998
Extended the commercial reef fish permit moratorium for another five years, from its previous expiration date of December 31, 2000 to December 31, 2005.	Amendment 17	2000
Prohibited vessels with commercial harvests of reef fish aboard from also retaining fish caught under recreational bag and possession limits.	Amendment 18A	2006
Established two marine reserve areas off the Tortugas area and prohibits fishing for any species and anchoring by fishing vessels inside the two marine reserves.	Amendment 19	2002
Established a 3-year moratorium on the issuance of new charter and headboat vessel permits in the recreational for hire fisheries in the Gulf EEZ. Allowed transfer of permits. Required vessel captains/owners to participate in data collection efforts.	Amendment 20	2002
Continues the Madison-Swanson and Steamboat Lumps marine reserves for an additional 6 years, until July 2010. Modified the fishing restrictions within the reserves to allow surface trolling during May – October.	Amendment 21	2004
Established status determination criteria and biological reference points to be compliant with the Sustainable Fisheries Act. Revised the rebuilding plan to be compliant with the SFA, and revised the rebuilding target date to 2032. It also established bycatch reporting methodologies for the reef fish fishery	Amendment 22	2005
Extended the commercial reef fish permit moratorium indefinitely. Established a permanent limited access system for the commercial fishery for Gulf reef fish. Permits issued under the limited access system are renewable and transferable.	Amendment 24	2005
Extended the recreational for-hire reef fish permit moratorium indefinitely. Established a limited access system on for-hire reef fish and CMP permits. Permits are renewable and transferable in the same manner as currently prescribed for such permits.	Amendment 25	2006
Established an individual fishing quota (IFQ) system for the commercial red snapper fishery.	Amendment 26	2007

<p>Set TAC at 5.0 mp between 2008 and 2010. The commercial sector will receive a quota of 2.55 mp, with the remaining quota of 2.45 mp going to the recreational sector. Also reduced the commercial size limit to 13" TL, reduced the recreational bag limit to two fish with a 16" TL minimum size limit, asset a zero bag limit for captain and crew aboard a for-hire vessel, and set the recreational fishing season from June 1 – September 30. In addition, all commercial and recreational reef fish fisheries will be required to use non-stainless steel circle hooks when using natural baits, as well as venting tools and dehooking devices.</p>	<p>Amendment 27</p>	<p>2008</p>
<p>Established a red snapper federal for-hire component that includes all for-hire operators with a valid or renewable federal reef fish for-hire permit, and a private angling component that includes all other for-hire operators and private recreational anglers. Allocated the recreational red snapper ACL and ACT based on 50% of the average percentages landed by each component between 1986 and 2013 (2010 excluded) and 50% of the average percentages between 2006 and 2013 (2010 excluded). This resulted in federal for-hire and private angling allocations of 42.3% and 57.7%, respectively. Established separate red snapper season closure provisions for the federal for-hire and private angling components.</p>	<p>Amendment 40</p>	<p>May 2015</p>
<p>Extended the 3-year sunset provision for the Gulf of Mexico red snapper recreational sector separation measure and the respective red snapper component ACLs and ACTs for an additional 5 years (through 2022).</p>	<p>Amendment 45</p>	<p>January 2016</p>
<p>Revised the commercial and recreational allocation for red snapper so that 48.5% of the total ACL is allocated to the commercial sector and 51.5% to the recreational sector. The increase for the recreational sector is the amount attributable to the re-calibration of Marine Recreational Information Program (MRIP) catch estimates between 2015 and 2017. *Note: A court order vacated this amendment and NOAA Fisheries reinstated the previous sector allocations (51 commercial / 49 recreational).</p>	<p>Amendment 28 <b>RESCINDED</b></p>	<p>May 2016</p>
<p>Standardized the minimum stock size threshold (MSST) for certain reef fish species, including red snapper, as 50% of B<sub>MSY</sub>; if the biomass of the stock falls below MSST then the stock is considered to be overfished.</p>	<p>Amendment 44</p>	<p>December 2017</p>
<p>Required all reef fish permitted vessels landing federally managed reef-fish to land at approved locations and hail-in at least 3 hours, but no more than 24 hours before landing. Returned red snapper shares from non-activated individual fishing quota (IFQ) accounts to NMFS for redistribution and allows NMFS to withhold a portion of IFQ allocation at the start</p>	<p>Amendment 36A</p>	<p>Shares and quota: July 2018  Landing req't: January 2019</p>

<p>of the year equal to an anticipated quota reduction.</p>		
<p>Delegated some management authority for recreational fishing of red snapper by private anglers in federal waters to the Gulf states. Each state was allocated a portion of the red snapper private angling ACL and has authority to set the private angling fishing season, bag limit, and minimum size limit (between 14-18 inches TL). If the landings of a state exceed that state’s ACL, the state’s ACL will be reduced by the amount of the overage in the following year. The state specific private angling ACL percentages are as follows:</p> <p style="padding-left: 40px;">Louisiana: 19.120%</p> <p style="padding-left: 40px;">Mississippi: 3.550%</p> <p style="padding-left: 40px;">Alabama: 26.298%</p> <p style="padding-left: 40px;">Florida: 44.822%</p> <p style="padding-left: 40px;">Texas: 6.210%</p>	<p>Amendments 50A-F</p>	<p>February 2020</p>

*GMFMC Regulatory Amendments:*

**1991 Regulatory Amendment (March 1991):**

Reduced the red snapper TAC from 5.0 million pounds to 4.0 million pounds to be allocated with a commercial quota of 2.04 million pounds and a 7-fish recreational daily bag limit (1.96 million pound allocation) beginning in 1991.

**1992 Regulatory Amendment (January 1993):**

Raised the 1993 red snapper TAC from 4.0 million pounds to 6.0 million pounds to be allocated with a commercial quota of 3.06 million pounds and a recreational allocation of 2.94 million pounds (to be implemented by a 7-fish recreational daily bag limit). The amendment also changed the target year to achieve a 20 percent red snapper SPR from 2007 to 2009, based on the Plan provision that the rebuilding period may be for a time span not exceeding 1.5 times the potential generation time of the stock and an estimated red snapper generation time of 13 years (Goodyear 1992).

**1993 Regulatory Amendment (January 1994):**

Implemented January 1, 1994- set the opening date of the 1994 commercial red snapper fishery as February 10, 1994, and restricted commercial vessels to landing no more than one trip limit per day. Commercial quota set at 3.06 mp, recreational quota set at 2.94 mp.

**October 1994 Regulatory Amendment (October 1994):**

Retained the 6 million pound red snapper TAC and commercial trip limits and set the opening date of the 1995 commercial red snapper fishery as February 24, 1995; however, because the recreational sector exceeded its 2.94 million pound red snapper allocation each year since 1992, this regulatory amendment reduced the daily bag limit from 7 fish to 5 fish, and increased the minimum size limit for recreational fishing from 14 inches to 15 inches a year ahead of the scheduled automatic increase.

**1995 Regulatory Amendment (December 1995):**

Raised the red snapper TAC from 6 million pounds to 9.12 million pounds, with 4.65 million pounds allocated to the recreational sector. Recreational size and bag limits remained at 5 fish and 15 inches total length. The recovery target date to achieve 20 percent SPR was extended to the year 2019, based on new biological information that red snapper live longer and have a longer generation time than previously believed. Commercial red snapper season was set to open on February 28.

**1996 Regulatory Amendment (March 1996):**

An addendum to the 1995 regulatory amendment split the 1996 and 1997 commercial red snapper quotas into two seasons each, with the first season opening on February 1 with a 3.06 million pound quota, and the second season opening on September 15 with the remainder of the annual quota.

**1997 Regulatory Amendment (September/October 1997):**

Changed the opening date of the second 1997 commercial red snapper season from September 15 to September 2 at noon and closed the season on September 15 at noon; thereafter the commercial season was opened from noon of the first day to noon of the fifteenth day of each month until the 1997 quota was reached. The recreational season would be closed when landings were projected to exceed the recreational allocation.

**1997 Regulatory Amendment (January 1998):**

Canceled a planned increase in the red snapper minimum size limit to 16 inches that had been implemented through Amendment 5, and retained the 15-inch minimum size limit.

**1998 Regulatory Amendment (April/May 1998):**

Proposed maintaining the status quo red snapper TAC of 9.12 million pounds, but set a zero bag limit for the captain and crew of for-hire recreational vessels in order to extend the recreational red snapper quota season. The NMFS provisionally approved the TAC, releasing 6 million pounds, with release of all or part of the remaining 3.12 million pounds to be contingent upon the capability of shrimp trawl bycatch reduction devices (BRDs) to achieve better than a 50 percent reduction in juvenile red snapper shrimp trawl mortality. The zero bag limit for captain and crew of for-hire recreational vessels was not implemented. Following an observer monitoring program of shrimp trawl BRDs conducted during the Summer of 1998, NMFS concluded that BRDs would be able to achieve the reduction in juvenile red snapper mortality needed for the red snapper recovery program to succeed, and the 3.12 million pounds of TAC held in reserve was released on September 1, 1998.

**1998 Regulatory Amendment (January 1999):**

Proposed to maintain the status quo red snapper TAC of 9.12 million pounds; reduce the recreational bag limit for red snapper to 4 fish for recreational fishermen and zero fish for captain and crew of for-hire vessels; set the opening date of the recreational red snapper fishing season to March 1; reduce the minimum size limit for red snapper to 14 inches total length for both the commercial and recreational fisheries; and change the opening criteria for the second commercial red snapper fishing season from the first 15 days to the first 10 days of each month beginning September 1, until the sub-allocation is met or the season closes on December 31.

**2000 Regulatory Amendment (January 2000):**

Maintained the status quo red snapper TAC of 9.12 million pounds for the next two years, pending an annual review of the assessment; increase the red snapper recreational minimum size limit from 15 inches to 16 inches total length; set the red snapper recreational bag limit at 4 fish; reinstate the red snapper recreational bag limit for captain and crew of recreational for-hire vessels; set the recreational red snapper season to be April 15 through October 31, subject to revision by the Regional Administrator to accommodate reinstating the bag limit for captain and crew, set the commercial red snapper Spring season to open on February 1 and be open from noon on the 1st until noon on the 10th of each month until the Spring sub-quota is reached; set the commercial red snapper Fall season to open on October 1 and be open from noon on the 1<sup>st</sup> to noon on the 10th of each month until the remaining commercial quota is reached; retain the red snapper commercial minimum size limit at status quo 15 inches total length; and allocate the red snapper commercial season sub-quota at 2/3 of the commercial quota, with the Fall season sub-quota as the remaining commercial quota.

**2010 Regulatory Amendment (June 2010):**

Increased red snapper total allowable catch from 5.0 million pounds (MP) to 6.945 MP. Based on the current 51% commercial and 49% recreational allocation of red snapper, the proposed total allowable catch increase would adjust the commercial and recreational quotas from 2.55 and 2.45 MP to 3.542 and 3.403 MP, respectively. The commercial sector is under an individual fishing quota program and has maintained landings within their quota in recent years.

**2011 Regulatory Amendment (May 2011):**

Increases the red snapper total allowable catch from 6.945 million pounds (MP) to 7.185 MP. Based on the current 51% commercial and 49% recreational allocation of red snapper, the increase in total allowable catch will adjust the commercial and recreational quotas from 3.542 and 3.403 MP to 3.66 MP and 3.525 MP in 2011. The commercial sector is under an individual fishing quota program and has maintained landings within their quota in recent years.

**2012 Regulatory Amendment (June 2012):**

Eliminates the fixed October 1 through December 31 closed season for recreational red snapper fishing. Increases the commercial and recreational quotas from 3.66 and 3.525 MP to 4.121 MP and 3.959 MP in 2012. In addition, increases the 2013 commercial and recreational quotas to 4.432 MP and 4.258 MP. Contingent upon the 2012 ABC of 8.080 MP not being exceeded. The commercial sector is under an individual fishing quota program and has maintained landings within their quota in recent years.

*GMFMC Framework Actions:*

**2013 Framework Action to Set the 2013 Red Snapper Commercial and Recreational Quotas (May 2013):**

Increased red snapper quotas from 4.121 mp ww to 4.315 mp ww for the commercial sector, and from 3.959 mp ww to 4.145 mp ww for the recreational sector. Was projected to result in a 27-day recreational season, beginning June 1, provided that Texas maintains its existing state regulations and the remaining Gulf States adopted consistent regulations.

**2013 Framework Action Addressing Vermilion Snapper, Yellowtail Snapper, and Venting Tool Requirements (September 2013):**

Removed the requirement to have onboard and use venting tools when releasing reef fish.

**2013 Framework Action to Establish 2013 Red Snapper Quotas and Supplemental Recreational Red Snapper Season (October 2013):**

Increased the 2013 quotas for commercial and recreational harvest of red snapper in the Gulf of Mexico to 5.61 mp ww and 5.39 mp ww, respectively, and reopened the recreational fishing season for red snapper for a supplemental season on October 1, 2013.

**2014 Framework Action to Require Electronic Reporting for Headboats (March 2014):**

Modified the frequency of headboat reporting to be on a weekly basis (or intervals shorter than a week if notified by the SRD) via electronic reporting, and will be due by 11:59 p.m., local time, the Sunday following a reporting week. If no fishing activity occurs during a reporting week, an electronic report so stating must be submitted for that week.

**2015 Framework Action to Establish Recreational Accountability Measures for Red Snapper (April 2015):**

Added two long-term recreational accountability measures for red snapper: a recreational ACT set 20% below the recreational ACL, against which the recreational fishing season is projected; and, a payback provision applied only when the red snapper population is considered over-fished.

**2015 Framework Action to Adjust Red Snapper Quotas for 2015 and Beyond (June 2015):**

Set the commercial and recreational ACLs and the recreational ACTs for 2015 – 2017 and subsequent fishing years in mp ww) for red snapper based on the ABCs recommended by the SSC and on the current commercial and recreational allocations (51-percent commercial and 49-percent recreational).

Year	ABC	Total Quota	Comm Quota	Rec Quota	Rec ACT
2015	14.30 mp	14.30 mp	7.293 mp	7.007 mp	5.605 mp
2016	13.96 mp	13.96 mp	7.120 mp	6.840 mp	5.473 mp
2017+	13.74 mp	13.74 mp	7.007 mp	6.733 mp	5.386 mp

**2018 Framework Action to Modify the Number of Unrigged Hooks Carried Onboard Bottom Longline Vessels (February 2018):**

Removed the 1000-hook limitation on the number of unrigged hooks allowed per bottom longline vessel in the eastern Gulf EEZ, while retaining the limit of 750 hooks that can be rigged for fishing.

**2019 Framework Action to Modify Red Snapper and Hogfish Catch Limits (April 2019):**

Increased the commercial and recreational ACL and recreational ACT for red snapper, and reduced the buffer between the ACL and ACT for red snapper for the federal for-hire



component from 20% to 9% in 2019 only. The 2018 and new red snapper ACLs and ACTs in mp ww are listed below:

<b>Red Snapper Sector</b>	<b>2018 ACL</b>	<b>2019+ ACL</b>	<b>2018 ACT</b>	<b>2019 and 2020+ ACT</b>
Commercial	7.007	7.701	n/a	n/a
Total Recreational	6.733	7.399	5.386	6.263 (2019) 5.919 (2020+)
Private	3.885	4.269	3.108	3.415
Federal For-Hire	2.848	3.130	2.278	2.848 (2019) 2.504 (2020+)

### **2020 Framework Action for Modification to the Recreational For-hire Red Snapper Annual Catch Target Buffer (March 2020):**

Reduced the buffer between the ACL and ACT for the federal for-hire component for red snapper to 9%.

### **2021 Framework Action – Modification of Fishing Access in Eastern Gulf of Mexico Marine Protected Areas (August 2021):**

Modifies regulations within Madison-Swanson and Steamboat Lumps Marine Protected Areas. In both areas, fishing is prohibited year-round. Possession of reef fish is prohibited for vessels in transit unless the vessel has an operating vessel monitoring system, a valid federal commercial Gulf of Mexico Reef Fish Permit, and fishing gear is appropriately stowed.

### **2023 Framework Action – Modification of Annual Catch Limits for Red Snapper (January 2023):**

Increased red snapper catch limits in pounds, whole weight to:

<b>Catch Limit Type</b>	<b>Current (2022)</b>	<b>New (2023)</b>	<b>Calculation</b>
OFL	15,500,000	25,600,000	N/A
ABC	15,100,000	15,400,000	60.1% of the OFL
Total ACL	15,100,000	15,400,000	ACL = ABC
Commercial ACL	7,701,000	7,854,000	51% of ABC
Recreational ACL	7,399,000	7,546,000	49% of ABC
Federal For-Hire ACL	3,130,000	3,191,958	42.3% of Recreational ACL
Federal For-Hire ACT	2,848,000	2,904,682	9% below For-Hire ACL
Private Angling ACL	4,269,000	4,354,042	57.7% of Recreational ACL
Private Angling ACT*	3,415,200	3,483,234	20% below Private Angling ACL

### **2023 Framework Action –Red Snapper Recreational Data Calibration and Catch Limits (January 2023):**

Applied the calibration ratios developed by NOAA Fisheries Office of Science and Technology and the Gulf of Mexico States to state-specific ACLs to adjust those ACLs into the currency in

which each state monitors landings. The private recreational red snapper ACL for each state, expressed in pounds whole weight as follows:

State	Federal Equivalent	Calibration Ratio	State Annual Catch Limit
Alabama	1,145,026	0.4875	558,200
Florida	1,951,569	1.0602	2,069,053
Louisiana	832,493	1.06	882,443
Mississippi	154,568	0.3840	59,354
Texas	270,386	1.00	270,386

**2023 Framework Action – Modification of Annual Catch Limits for Red Snapper (July 2023):**

Increased red snapper catch limits in pounds, whole weight to:

Catch Limit Type	Catch Limit
OFL	18,910,000
ABC	16,310,000
Total ACL	16,310,000
Commercial ACL	8,318,100
Recreational ACL	7,991,900
Federal For-Hire ACL	3,380,574
Federal For-Hire ACT	3,076,322
Private Angling ACL	4,611,326
Private Angling ACT*	3,689,061

**2.2. Emergency and Interim Rules**

**Emergency- 1992:**

Opened commercial red snapper fishery from April 3 - May 14 with a 1000 lb. trip limit due to the season closing in only 53 days. Effective 4/3/92

**Emergency- 1992:**

Created commercial red snapper 2000 lb and 200 lb endorsements for 1993. Effective 12/30/92 - 3-30-93.

**Emergency- 1992:**

Closed the commercial red snapper fishery from 12-30-92 to 2-15-93.

**Emergency- 1998:**

Reduced recreational bag limit of red snapper from 5 fish per person to 4 fish per person. Reopened the recreational red snapper fishery in January 1999. Effective 6/29/99 to 12/26/99.

**Interim- 1999:**

Increased recreational minimum size limit to 18" TL. Closed the recreational fishery in the EEZ on 8/29/1999. Effective 6/4/99 to 8/29/99.

**Interim- 1999:**

Changed 2000 recreational season from April 24 to October 1. Reinstated the 4-fish bag limit for captain and crew. Reduced the opening of the spring commercial season from 15 to 10 days. Effective 1/19/00 to 12/16/00.

**Interim- 2007:**

Reduced catch quota to 6.5 mp (commercial: 3.315; recreational 3.185). Reduced bag limits to 2 fish/person/day, and prohibited captains and crew of for-hire vessels from keeping the recreational bag limit. Reduced size limit for commercial vessels from 15" to 13" TL (effective 4/2/07). Established a target for the reduction of red snapper bycatch mortality in the shrimp fishery. Effective 5/2/07.

**2.3. Control Date Notices**

Control date notices are used to inform fishermen that a license limitation system or other method of limiting access to a particular fishery or fishing method is under consideration. If a program to limit access is established, anyone not participating in the fishery or using the fishing method by the published control date may be ineligible for initial access to participate in the fishery or to use that fishing method. However, a person who does not receive an initial eligibility may be able to enter the fishery or fishing method after the limited access system is established by transfer of the eligibility from a current participant, provided the limited access system allows such transfer. Publication of a control date does not obligate the Council to use that date as an initial eligibility criteria. A different date could be used, and additional qualification criteria could be established. The announcement of a control date is primarily intended to discourage entry into the fishery or use of a particular gear based on economic speculation during the Council's deliberation on the issues. The following summarizes control dates that have been established for the Reef Fish FMP. A reference to the full *Federal Register* notice is included with each summary.

**November 1, 1989:**

Anyone entering the commercial reef fish fishery in the Gulf and South Atlantic after November 1, 1989, may not be assured of future access to the reef fish resource if a management regime is developed and implemented that limits the number of participants in the fishery [54 FR 46755].

**November 18, 1998:**

The Council is considering whether there is a need to impose additional management measures limiting entry into the recreational-for-hire (i.e., charter vessel and headboat) fisheries for reef fish and coastal migratory pelagic fish in the EEZ of the Gulf and, if there is a need, what management measures should be imposed. Possible measures include the establishment of a limited entry program to control participation or effort in the recreational-for-hire fisheries for

reef fish and coastal migratory pelagic [63 FR 64031] (In Amendment 20 to the Reef Fish FMP, a qualifying date of March 29, 2001, was adopted).

**July 12, 2000:**

The Council is considering whether there is a need to limit participation by gear type in the commercial reef fish fisheries in the exclusive economic zone of the Gulf and, if there is a need, what management measures should be imposed to accomplish this. Possible measures include modifications to the existing limited entry program to control fishery participation, or effort, based on gear type, such as a requirement for a gear endorsement on the commercial reef fish vessel permit for the appropriate gear. Gear types which may be included are longlines, buoy gear, handlines, rod-and-reel, bandit gear, spear fishing gear, and powerheads used with spears [65 FR 42978].

**October 15, 2004:**

The Council is considering the establishment of an individual fishing quota program to control participation or effort in the commercial grouper fisheries of the Gulf. If an individual fishing quota program is established, the Council is considering October 15, 2004, as a possible control date regarding the eligibility of catch histories in the commercial grouper fishery [69 FR 67106].

**December 31, 2008:**

The Council voted to establish a control date for all Gulf commercial reef fish vessel permits. The control date will allow the Council to evaluate fishery participation and address any level of overcapacity. The establishment of this control date does not commit the Council or NOAA Fisheries Service to any particular management regime or criteria for entry into this fishery. Fishermen would not be guaranteed future participation in the fishery regardless of their entry date or intensity of participation in the fishery before or after the control date under consideration. Comments were requested by close of business April 17, 2009 [74 FR 11517].

**January 1, 2012:**

This notice announces that the Gulf of Mexico Fishery Management Council (Council) is considering creating additional restrictions limiting participation in the Red Snapper Individual Fishing Quota (IFQ) Program. If such management measures are implemented, the Council is considering January 1, 2012, as a possible control date. Anyone entering the program after the control date will not be assured of future access should a management regime that limits participation in the program be prepared and implemented [76 FR 74038].

## 2.4. Management Program Specifications

**Table 2.4.1. General Management Information**

Species	Red Snapper
Management Unit	Gulf of Mexico (East and West)
Management Unit Definition	Gulf of Mexico EEZ
Management Entity	Gulf of Mexico Fishery Management Council
Management Contacts SERO/Council	Ryan Rindone
Current Stock Exploitation Status	Not undergoing overfishing
Current Spawning Stock Biomass Status	Not overfished

**Table 2.4.2. Specific Management Criteria**

Criteria	Gulf of Mexico - Current (SEDAR 52)		Gulf of Mexico - Proposed	
	Definition	Value	Definition	Value
MSST	$0.5 * SSB_{MSY}$	6.15 E+14 eggs	$0.5 * SSB_{MSY}$	SEDAR 74
MFMT	$F_{SPR26\%}$	0.0588	$F_{SPR26\%}$	SEDAR 74
MSY	$F_{MSY}$	0.0588	$F_{MSY}$	SEDAR 74
$F_{MSY}$	$F_{SPR26\%}$	0.0588	$F_{SPR26\%}$	SEDAR 74
OY	Equilibrium Yield @ $F_{OY}$	13.35 mp	Equilibrium Yield @ $F_{OY}$	SEDAR 74
$F_{OY}$	75% of $F_{MSY}$	0.0564	$F_{OY} = 65\%, 75\%, 85\% F_{MSY}$	SEDAR 74
M	n/a	0.09	M	SEDAR 74

NOTE: “Proposed” columns are for indicating any definitions that may exist in FMPs or amendments that are currently under development and should therefore be evaluated in the current assessment. “Current” is those definitions in place now. Please clarify whether landings parameters are ‘landings’ or ‘catch’ (Landings + Discard). If ‘landings’, please indicate how discards are addressed.

### Stock Rebuilding Information

The original rebuilding plan for Gulf of Mexico red snapper was established in Reef Fish Amendment 1 in 1990, and has been revised numerous times. In 2001, the Council submitted a regulatory amendment to NMFS to revise the rebuilding plan to make it compliant with the provisions of the Sustainable Fisheries Act. In particular, this required an adjustment of the rebuilding target and a recalculation of the maximum rebuilding time. Previously the maximum rebuilding target had been to 20% SPR within 1 ½ generations times. Based on a starting date of 1990, and a generation time of 19.6 years (calculated in a 1996 stock assessment), this resulted in a rebuilding target date of 2019. Under the Sustainable Fisheries Act, both the rebuilding target stock level and time frame were changed. Stocks were now required to be rebuilt to a level capable of sustaining maximum sustainable yield with a time frame of 10 years or less. If stocks could not be rebuilt within 10 years, then the maximum rebuilding time was to be based on the time to rebuild in the

absence of fishing mortality plus 1 generation time. For red snapper, rebuilding in the absence of fishing mortality to a sustainable yield of  $F_{26\% SPR}$  (as a proxy for  $F_{MSY}$ ) was estimated to take 12 years. Based on a new starting date of 2000, the 12 years plus 19.6 years generation time resulted in a new target date of 2032.

The 2001 regulatory amendment was not accepted by NMFS because it lacked an environmental impact assessment. In its place, the current version of the rebuilding plan was established in Reef Fish Amendment 22, which was implemented in 2005, but maintained the 2000 – 2032 rebuilding period established in the rejected regulatory amendment. The preferred alternative (Alternative 2) specified the following:

Maintain TAC at 9.12 mp ww, end overfishing between 2009 and 2010, and rebuild red snapper by 2032. Review and adjust this policy, as necessary, through periodic assessments. Monitor annual landings to ensure quota is not exceeded.

**Table 2.4.3. Stock projection information**

*(This provides the basic information necessary to bridge the gap between the terminal year of the assessment and the year in which any changes may take place or specific alternative exploitation rates should be evaluated)*

Requested Information	Value
First Year of Management	2026
Projection Criteria during interim years should be based on (e.g., exploitation or harvest)	Fixed Exploitation
Projection criteria values for interim years should be determined from (e.g., terminal year, avg of X years)	Available landings data; if no data available, then use the average of the previous three years

\*Fixed Exploitation would be  $F=F_{MSY}$  (or  $F < F_{MSY}$ ) that would rebuild overfished stock to  $B_{MSY}$  in the allowable timeframe. Modified Exploitation would allow for adjustment in  $F \leq F_{MSY}$ , which would allow for the largest landings that would rebuild the stock to  $B_{MSY}$  in the allowable timeframe. Fixed harvest would be maximum fixed harvest with  $F \leq F_{MSY}$  that would allow the stock to rebuild to  $B_{MSY}$  in the allowable timeframe.

**Projections:**

Project future stock conditions and develop rebuilding schedules if warranted, including estimated generation time. Develop stock projections in accordance with the following:

- A) If stock is overfished:  $F=0, F_{Current}, F_{MSY}, F_{OY}$   
 $F=F_{Rebuild}$  (max that permits rebuild in allowed time)
- B) If stock is undergoing overfishing:  $F= F_{Current}, F_{MSY}, F_{OY}$
- C) If stock is neither overfished nor undergoing overfishing:  $F= F_{Current}, F_{MSY}, F_{OY}$

D) If data limitations preclude classic projections (i.e. A, B, C above), explore alternate models to provide management advice

**Table 2.4.4. Quota Calculation Details**

If the stock is managed by quota, please provide the following information

Current ABC Value (2023)	16.31 mp ww
Next Scheduled Quota Change	2026
Annual or averaged quota ?	Annual
If averaged, number of years to average	n/a
Does the quota include bycatch/discard ?	No

## 2.2. Management and Regulatory Timeline

### Tables 2.2.1. Pertinent Federal management information.

Harvest Restrictions: Trip Limits

\*Trip limits do not apply during closures (if season is closed, then trip limit is 0)

First Yr In Effect	Effective Date	End Date	Fishery	Bag Limit Per Person/Day	Bag Limit Per Boat/Day	Region Affected	FR Reference	Amendment Number or Rule Type	* Notes
1984	11/1/84	4/22/90	Rec	none	none	Gulf of Mexico EEZ	55 FR 2078	Original Reef Fish FMP	
1990	4/23/90	12/31/94	Rec	7 fish*	none	Gulf of Mexico EEZ	55 FR 2078	Reef Fish Amendment 1	Within 10 snapper recreational aggregate bag limit
1995	10/1/94	4/30/98	Rec	5 fish*	none	Gulf of Mexico EEZ		Oct 1994 Reg Amendment	"
1998	5/1/98	5/1/07	Rec	4 fish*	none	Gulf of Mexico EEZ		Interim Rule	"
2007	5/2/07	2/5/20	Rec	2 fish*	none	Gulf of Mexico EEZ		Interim Rule/RF Amendment 27	"
2020	2/6/20	Present	Rec	Can vary by state	none	Gulf of Mexico EEZ	85 FR 6819	Reef Fish Amendment 50A	States can set individual bag limit; can vary by state and year, and within fishing years
2007	5/2/07	Present	For-hire	0 capt/crew	none	Gulf of Mexico EEZ			

Note: Beginning with the 2020 fishing season, the private recreational component daily bag limit is determined by each respective Gulf state. At the date of this file, the above regulations are accurate.



Harvest Restrictions: Size Limits

\*Size limits do not apply during closures

First Yr In Effect	Effective Date	End Date	Fishery	Size Limit	Length Type	Region Affected	FR Reference	Amendment Number or Rule Type	* Notes
1984	11/1/84	2/20/90	Both*	13"	Minimum TL	Gulf of Mexico EEZ		Original Reef Fish FMP	For-hire exempted until 1987; each angler could keep 5 undersized red snapper per day
1990	2/21/90	2/6/94	Both	13"	Minimum TL	Gulf of Mexico EEZ	55 FR 2078	Reef Fish Amendment 1	
1994	2/7/94	10/1/94	Both	14"	Minimum TL	Gulf of Mexico EEZ	59 FR 966	Reef Fish Amendment 5	
1994	10/1/94	6/3/99	Rec	15"	Minimum TL	Gulf of Mexico EEZ		Oct 1994 Reg Amendment	
1994	10/1/94	1/31/08	Com	15"	Minimum TL	Gulf of Mexico EEZ		Oct 1994 Reg Amendment	
1999	6/4/99	8/29/99	Rec	18"	Minimum TL	Gulf of Mexico EEZ		Emergency Rule	
1999	8/30/99	1/31/00	Rec	15"	Minimum TL	Gulf of Mexico EEZ		Emergency Rule expiration	
2000	2/1/00	Present	Rec	16"	Minimum TL	Gulf of Mexico EEZ		Feb 2000 Reg Amendment	
2008	2/1/08	Present	Com	13"	Minimum TL	Gulf of Mexico EEZ		RF Amendment 27	

Quota History – Recreational

<b>First Yr In Effect</b>	<b>Effective Date</b>	<b>End Date</b>	<b>Quota or ACL</b>	<b>Region Affected</b>	<b>FR Reference</b>	<b>Amendment Number or Rule Type</b>
1990	4/23/90	2/28/91	NA	Gulf of Mexico EEZ		
1991	3/1/91	9/30/92	1.96 mp ww	Gulf of Mexico EEZ	55 FR 2078	Reef Fish Amendment 1
1992	10/1/92	11/30/95	2.94 mp ww	Gulf of Mexico EEZ		Oct 1992 Reg Amendment
1996	12/1/95	12/31/96	4.65 mp ww	Gulf of Mexico EEZ		Dec 1995 Reg Amendment
1997	1/1/97	11/27/97	4.47 mp ww	Gulf of Mexico EEZ		
1998	1/1/98	12/31/98	"	Gulf of Mexico EEZ		
1999	1/1/99	12/31/99	"	Gulf of Mexico EEZ		
2000	2/1/00	12/31/00	"	Gulf of Mexico EEZ		Feb 2000 Reg Amendment
2001	1/1/01	12/31/01	"	Gulf of Mexico EEZ		
2002	1/1/02	12/31/02	"	Gulf of Mexico EEZ		
2003	1/1/03	12/31/03	"	Gulf of Mexico EEZ		
2004	1/1/04	12/31/04	"	Gulf of Mexico EEZ		
2005	1/1/05	12/31/05	"	Gulf of Mexico EEZ		
2006	1/1/06	12/31/06	"	Gulf of Mexico EEZ		
2007	1/1/07	12/31/07	3.185 mp ww	Gulf of Mexico EEZ		
2008	2/1/08	12/31/08	2.45 mp ww	Gulf of Mexico EEZ		RF Amendment 27
2009	1/1/09	12/31/09	2.45 mp ww	Gulf of Mexico EEZ		
2010	1/1/10	12/31/10	3.403 mp ww	Gulf of Mexico EEZ		2010 Reg Amendment
2011	1/1/11	12/31/11	3.867 mp ww	Gulf of Mexico EEZ		2011 Reg Amendment
2012	1/1/12	12/31/12	3.959 mp ww	Gulf of Mexico EEZ		2012 Reg Amendment
2013	1/1/13	12/31/13	5.39 mp ww	Gulf of Mexico EEZ		2013 Framework Action
2014	1/1/14	12/31/14	"	Gulf of Mexico EEZ		
2015	1/1/15	12/31/15	7.007 mp ww	Gulf of Mexico EEZ		2015 Framework Action
2016	1/1/16	12/31/16	7.192 mp ww	Gulf of Mexico EEZ		
2017	1/1/17	12/31/17	6.603 mp ww	Gulf of Mexico EEZ		

Quota History – Commercial

First Yr In Effect	Effective Date	End Date	Quota or ACL	Region Affected	FR Reference	Amendment Number or Rule Type	Notes
1990	4/23/90	2/28/91	3.1 mp ww	Gulf of Mexico EEZ	55 FR 2078	Reef Fish Amendment 1	
1991	3/1/91	9/30/92	2.04 mp ww	Gulf of Mexico EEZ		March 1991 Reg Amendment	
1992	10/1/92	11/30/95	2.04 + emergency	Gulf of Mexico EEZ		Oct 1992 Reg Amendment	
1993	1/1/93	12/31/93	3.06 mp ww	Gulf of Mexico EEZ			
1994	1/1/94	12/31/94	"	Gulf of Mexico EEZ			
1995	1/1/95	12/31/95	"	Gulf of Mexico EEZ			
1996	3/1/96	12/31/96	4.65 mp ww	Gulf of Mexico EEZ		Dec 1995 Reg Amendment	
1997	1/1/97	12/31/97	"	Gulf of Mexico EEZ			
1998	1/1/98	12/31/98	"	Gulf of Mexico EEZ			
1999	1/1/99	12/31/99	"	Gulf of Mexico EEZ			
2000	2/1/00	12/31/00	"	Gulf of Mexico EEZ		Feb 2000 Reg Amendment	
2001	1/1/01	12/31/01	"	Gulf of Mexico EEZ			
2002	1/1/02	12/31/02	"	Gulf of Mexico EEZ			
2003	1/1/03	12/31/03	"	Gulf of Mexico EEZ			
2004	1/1/04	12/31/04	"	Gulf of Mexico EEZ			
2005	1/1/05	12/31/05	"	Gulf of Mexico EEZ			
2006	1/1/06	12/31/06	"	Gulf of Mexico EEZ			
2007	1/1/07	12/31/07	"	Gulf of Mexico EEZ			In-season quota increase of 689,189 lbs gw on June 1
2008	2/1/08	12/31/08	2.55 mp ww	Gulf of Mexico EEZ		RF Amendment 27	
2009	1/1/09	12/31/09	2.55 mp ww	Gulf of Mexico EEZ			
2010	1/1/10	12/31/10	3.542 mp ww	Gulf of Mexico EEZ		2010 Reg Amendment	In-season quota increase of 893,694 lbs gw on June 2
2011	1/1/11	12/31/11	3.66 mp ww	Gulf of Mexico EEZ		2011 Reg Amendment	In-season quota increase of 109,910 lbs gw on May 31
2012	1/1/12	12/31/12	4.121 mp ww	Gulf of Mexico EEZ		2012 Reg Amendment	In-season quota increase of 411,712 lbs gw on June 29

Quota History Commercial		(Continued)					
First Yr In Effect	Effective Date	End Date	Quota or ACL	Region Affected	FR Reference	Amendment Number or Rule Type	Notes
2013	1/1/13	12/31/13	5.610 mp ww	Gulf of Mexico EEZ		2013 Framework Action	In-season quota increases of 174,774 lbs gw on May 29; and 1,166,667 on September 30
2014	1/1/14	12/31/14	5.610 mp ww	Gulf of Mexico EEZ			
2015	1/1/15	12/31/15	7.293 mp ww	Gulf of Mexico EEZ		2015 Framework Action	In-season quota increase of 1,516,216 lbs gw on June 1
2016	1/1/16	12/31/16	7.120 mp ww	Gulf of Mexico EEZ			
2017	1/1/17	12/31/17	7.007 mp ww	Gulf of Mexico EEZ			
2018	1/1/18	12/31/18	7.701 mp ww	Gulf of Mexico EEZ			
2019	1/1/19	12/31/19	7.701 mp ww	Gulf of Mexico EEZ			
2020	1/1/20	12/31/20	7.701 mp ww	Gulf of Mexico EEZ			
2021	1/1/21	12/31/21	7.701 mp ww	Gulf of Mexico EEZ			
2022	1/1/22	12/31/22	7.701 mp ww	Gulf of Mexico EEZ			
2023	1/1/23	7/9/23	7.854 mp ww	Gulf of Mexico EEZ	87 FR 74104	2022 Framework Action	
2023	7/10/23	12/31/23	8.318 mp ww	Gulf of Mexico EEZ	88 FR 37475	2023 Framework Action	

Harvest Restrictions (Fishery Closures\*)

\*Area specific regulations are documented under spatial restrictions

First Yr In Effect	Effective Date	End Date	Fishery	Closure Type	First Day Closed	Last Day Closed	Region Affected	FR Reference	Amendment Number or Rule Type	* Notes
1991	8/24/91	12/31/91	Com	Quota	24-Aug	31-Dec	Gulf of Mexico EEZ		Notice of Closure	
1992	2/22/92	12/31/92	Com	Quota	23-Feb	31-Dec	Gulf of Mexico EEZ	65 FR 31827	Reef Fish Regulatory Amendment	
1993			Com	Seasonal			Gulf of Mexico EEZ			
1994	10/1/93	9/30/94	Com	Seasonal	1-Jan	9-Feb	Gulf of Mexico EEZ		Oct 1993 Reg Amendment	
1995	10/1/94	12/31/95	Com	Seasonal	1-Jan	24-Feb	Gulf of Mexico EEZ		Oct 1994 Reg Amendment	
1996	3/1/96	2/28/97	Com	Seasonal*	1-Jan	31-Jan	Gulf of Mexico EEZ		Dec 1995 Reg Amendment*	Set up two season structure. Season 1 opened on February 1, and season 2 on September 15
1997	3/1/97	1/31/00	Com	Seasonal*	*	*	Gulf of Mexico EEZ		March 1997 Reg Amendment	Changed the opening date of the second 1997 commercial red snapper season from September 15 to September 2 at noon and closed the season on September 15 at noon; thereafter the commercial season was opened from noon of the first day to noon of the fifteenth day of each month until the 1997 quota was reached.
1997	11/27/97	12/31/97	Rec	Quota	27-Nov	31-Dec	Gulf of Mexico EEZ		March 1997 Reg Amendment	
2000	2/1/00	1/31/08	Rec	Seasonal	1-Jan	14-Apr	Gulf of Mexico EEZ		Feb 2000 Reg Amendment	
2000	2/1/00	1/31/08	Rec	Seasonal	1-Nov	31-Dec	Gulf of Mexico EEZ		Feb 2000 Reg Amendment	
2000	2/1/00	12/31/07	Com	Seasonal*	1-Jan	31-Jan	Gulf of Mexico EEZ		Feb 2000 Reg Amendment	Open from noon on the 1st until noon on the 10th of each month until the Spring sub-quota is reached; October 1 and be open from noon on the 1st to noon on the 10th of each month until the remaining commercial quota is reached
2000	2/1/00	12/31/07	Com	Seasonal*	1-Jan	31-Jan	Gulf of Mexico EEZ		Feb 2000 Reg Amendment	
2007	1/1/07	Present	Com	IFQ	-	-	Gulf of Mexico EEZ		RF Amendment 26	Established the Commercial IFQ program
2008	2/1/08	12/31/11	Rec	Seasonal	1-Jan	31-May	Gulf of Mexico EEZ		RF Amendment 27	
2008	2/1/08	12/31/11	Rec	Seasonal	1-Oct	31-Dec	Gulf of Mexico EEZ		RF Amendment 27	
2012	1/1/12	Present	Rec	Seasonal	1-Jan	31-May	Gulf of Mexico EEZ		2012 Reg Amendment	

## Harvest Restrictions (Spatial restrictions)

Area	First Yr In Effect	Effective Date	End Date	Fishery	First Day Closed	Last Day Closed	Restriction in Area	FR Reference	Amendment Number or Rule Type
Gulf of Mexico Stressed Areas	1984	11/8/84	Ongoing	Both	Year round		Prohibited powerheads for Reef FMP	49 FR 39548	Original Reef Fish FMP
	1984	11/8/84	Ongoing	Both	Year round		Prohibited pots and traps for Reef FMP	49 FR 39548	Original Reef Fish FMP
EEZ, inside 50 fathoms west of Cape San Blas, FL	1990	2/21/90	Ongoing	Both	Year round		Prohibited longline and buoy gear for Reef FMP	55 FR 2078	Reef Fish Amendment 1
EEZ, inside 20 fathoms east of Cape San Blas, FL	1990	2/21/90	4/17/09	Both	Year round		Prohibited longline and buoy gear for Reef FMP	55 FR 2078	Reef Fish Amendment 1
Alabama Special Management Zones	1994	2/7/94	Ongoing	Both	Year round		Allow only hook-and line gear with three or less hooks per line and spearfishing gear for fish in Reef FMP	59 FR 966	Reef Fish Amendment 5
EEZ, inside 50 fathoms east of Cape San Blas, FL	2009	5/18/09	10/15/09	Both	18-May	28-Oct	Prohibited bottom longline for Reef FMP	74 FR 20229	Emergency Rule
EEZ, inside 35 fathoms east of Cape San Blas, FL	2009	10/16/09	4/25/10	Both	Year round		Prohibited bottom longline for Reef FMP	74 FR 53889	Sea Turtle ESA Rule
	2010	4/26/10	Ongoing	Rec	Year round		Prohibited bottom longline for Reef FMP	75 FR 21512	Reef Fish Amendment 31
	2010	4/26/10	Ongoing	Com	1-Jun	31-Aug	Prohibited bottom longline for Reef FMP	75 FR 21512	Reef Fish Amendment 31
Madison-Swanson	2000	6/19/00	6/2/04	Both	Year round		Fishing prohibited except HMS <sup>1</sup>	65 FR 31827	Reef Fish Regulatory Amendment
	2004	6/3/04	Ongoing	Both	1-May	31-Oct	Fishing prohibited except surface trolling	70 FR 24532 74 FR 17603	Reef Fish Amendment 21 Reef Fish Amendment 30B
	2004	6/3/04	Ongoing	Both	1-Nov	30-Apr	Fishing prohibited	70 FR 24532 74 FR 17603	Reef Fish Amendment 21 Reef Fish Amendment 30B
Steamboat Lumps	2000	6/19/00	6/2/04	Both	Year round		Fishing prohibited except HMS <sup>1</sup>	65 FR 31827	Reef Fish Regulatory Amendment
	2004	6/3/04	Ongoing	Both	1-May	31-Oct	Fishing prohibited except surface trolling	70 FR 24532 74 FR 17603	Reef Fish Amendment 21 Reef Fish Amendment 30B
	2004	6/3/04	Ongoing	Both	1-Nov	30-Apr	Fishing prohibited	70 FR 24532 74 FR 17603	Reef Fish Amendment 21 Reef Fish Amendment 30B
Madison-Swanson and Steamboat Lumps	2021	8/20/21	Ongoing	Both	Year round		Fishing prohibited except HMS <sup>1</sup>	86 FR 38416	Reef Fish Framework Action
The Edges	2010	7/24/09	Ongoing	Both	1-Jan	30-Apr	Fishing prohibited	74 FR 30001	Reef Fish Amendment 30B Supplement
20 Fathom Break	2014	7/5/13	Ongoing	Rec	1-Feb	31-Mar	Fishing for SWG prohibited <sup>2</sup>	78 FR 33259	Reef Fish Framework Action
Flower Garden	1992	1/17/92	Ongoing	Both	Year round		Fishing with bottom gears prohibited <sup>3</sup>	56 FR 63634	Sanctuary Designation

Riley's Hump	1994	2/7/94	8/18/02	Both	1-May	30-Jun	Fishing prohibited	59 FR 966	Reef Fish Amendment 5
Tortugas Reserves	2002	8/19/02	Ongoing	Both		Year round	Fishing prohibited	67 FR 47467	Tortugas Amendment
Pulley Ridge	2006	1/23/06	Ongoing	Both		Year round	Fishing with bottom gears prohibited <sup>3</sup>	70 FR 76216	Essential Fish Habitat (EFH) Amendment 3
DWH Oil Spill closure	2010	5/2/10	11/15/10	Both			All fishing prohibited in designated areas	75 FR 24822	

<sup>1</sup>HMS: highly migratory species (tuna species, marlin, oceanic sharks, sailfishes, and swordfish)

<sup>2</sup>SWG: shallow-water grouper (black, gag, red, red hind, rock hind, scamp, yellowfin, and yellowmouth)

<sup>3</sup>Bottom gears: Bottom longline, bottom trawl, buoy gear, pot, or trap

**Harvest Restrictions (Gear Restrictions\*)**

\*Area specific gear regulations are documented under spatial restrictions

<b>Gear Type</b>	<b>First Yr In Effect</b>	<b>Effective Date</b>	<b>End Date</b>	<b>Gear/Harvesting Restrictions</b>	<b>Region Affected</b>	<b>FR Reference</b>	<b>Amendment Number or Rule Type</b>
Poison	1984	11/8/84	Ongoing	Prohibited for Reef FMP	Gulf of Mexico EEZ	49 FR 39548	Original Reef Fish FMP
Explosives	1984	11/8/84	Ongoing	Prohibited for Reef FMP	Gulf of Mexico EEZ	49 FR 39548	Original Reef Fish FMP
Pots and Traps	1984	11/23/84	2/3/94	Established fish trap permit	Gulf of Mexico EEZ	50 FR 39548	Original Reef Fish FMP
	1984	11/23/84	2/20/90	Set max number of traps fish by a vessel at 200	Gulf of Mexico EEZ	50 FR 39548	Original Reef Fish FMP
	1990	2/21/90	2/3/94	Set max number of traps fish by a vessel at 100	Gulf of Mexico EEZ	55 FR 2078	Reef Fish Amendment 1
	1994	2/4/94	2/7/97	Moratorium on additional commercial trap permits	Gulf of Mexico EEZ	59 FR 966	Reef Fish Amendment 5
	1997	3/25/97	2/6/07	Phase out of fish traps begins	Gulf of Mexico EEZ	62 FR 13983	Reef Fish Amendment 14
	1997	12/30/97	2/6/07	Prohibited harvest of reef fish from traps other than permitted reef fish, stone crab, or spiny lobster traps.	Gulf of Mexico EEZ	62 FR 67714	Reef Fish Amendment 15
	2007	2/7/07	Ongoing	Traps prohibited	Gulf of Mexico EEZ	62 FR 13983	Reef Fish Amendment 14
All	1992	4/8/92	12/31/95	Moratorium on commercial permits for Reef FMP	Gulf of Mexico EEZ	68 FR 11914 59 FR 39301	Reef Fish Amendment 4 Reef Fish Amendment 9
	1994	2/7/94	Ongoing	Finfish must have head and fins intact through landing, can be eviscerated, gilled, and scaled but must otherwise be whole (HMS and bait exceptions)	Gulf of Mexico EEZ	59 FR 39301	Reef Fish Amendment 9
	1996	6/1/96	12/31/05	Moratorium on commercial permits for Gulf reef fish.	Gulf of Mexico EEZ	61 FR 34930 65 FR 41016	Interim Rule Reef Fish Amendment 17
	2006	9/8/06	Ongoing	Use of Gulf reef fish as bait prohibited. <sup>1</sup>	Gulf of Mexico EEZ	71 FR 45428	Reef Fish Amendment 18A
Vertical Line	2008	6/1/08	Ongoing	Requires non-stainless steel circle hooks and dehooking devices	Gulf of Mexico EEZ	74 FR 5117	Reef Fish Amendment 27
	2008	6/1/08	9/3/13	Requires venting tools	Gulf of Mexico EEZ	74 FR 5117 78 FR 46820	Reef Fish Amendment 27 Framework Action
Longline	2009	10/16/09		750 hooks fishing	Gulf of Mexico EEZ		Endangered Species Act and regulatory action

<sup>1</sup>Except when, purchased from a fish processor, filleted carcasses may be used as bait crab and lobster traps.



## Season Lengths

Commercial Season Lengths - Pre-IFQ

Year	Days Open (days that open or close at noon are counted as half-days) (“+” = split season)
1986	365
1987	365
1988	365
1989	365
1990	365
1991	235
1992	$52\frac{1}{2} + 42 = 94\frac{1}{2}$
1993	94
1994	77
1995	$50 + 1\frac{1}{2} = 51\frac{1}{2}$
1996	$64 + 22 = 86$
1997	$53 + 18 = 71$
1998	$39 + 28 = 67$
1999	$42 + 22 = 64$
2000	$34 + 25 = 59$
2001	$50 + 20 = 70$
2002	$57 + 24 = 81$
2003	$60 + 24 = 84$
2004	$63 + 32 = 95$
2005	$72 + 48 = 120$
2006	$72 + 43 = 115$

## Recreational Season Lengths

Year	Component	<u># Days</u>	<u>Open date</u>	<u>Close date</u>
Pre-1990	Both	365	1-Jan	31-Dec
1990	Both	"	"	"
1991	Both	"	"	"
1992	Both	"	"	"
1993	Both	"	"	"
1994	Both	"	"	"
1995	Both	"	"	"
1996	Both	"	"	"
1997	Both	330	"	27-Nov
1998	Both	272	"	30-Sep
1999	Both	240	"	29-Aug
2000	Both	194	21-Apr	1-Nov
2001	Both	"	"	1-Nov
2002	Both	"	"	1-Nov
2003	Both	"	"	1-Nov
2004	Both	"	"	1-Nov
2005	Both	"	"	1-Nov
2006	Both	"	"	1-Nov
2007	Both	"	"	1-Nov
2008	Both	65	1-Jun	5-Aug
2009	Both	75	"	15-Aug
2010	Both	53	"	24-Jul
2011	Both	48	"	19-Jul
2012	Both	46	"	17-Jul
2013	Both	42	1-Jun; 1-Oct	29-June; 15-Oct
2014	Both	9	"	9-Jun
2015	Private	10	"	11-Jun
	For-hire	44	"	15-Jul
2016	Private	11	"	12-Jun
	For-hire	46	"	17-Jul
2017	Private	42	"	13-Jul
	For-hire	49	"	19-Jul

Year	Federal Season	Private Angling Component State Season				
		FL	AL	MS	LA	TX (State/Fed)
2010	77	77	77	77	77	365
2011	48	48	48	48	48	365
2012	46	46	46	46	46	366
2013	42	65	42	42	115	365
2014	9	52	21	36	286	365
2015	10	70	41	118	215	365
2016	11	85	66	102	272	366
2017*	42	65	67	102	135	365
2018**	**	40	24	76	60	365/82 ^
2019**	**	32	27	81	109	365/62 ^
2020***	***	45	35	45	41	366/64 ^
2021	***	55	124	119	146	365/318 ^
2022	***	57	126	215	61	365/94 ^
2023	***	87	72	75	220	365/ ^

\* The 2017 red snapper fishing season for private anglers was extended by 39 days on June 6th, 2017 by the Secretary of Commerce.

\*\* The 2018 and 2019 fishing seasons for private anglers were managed under EFPs for each Gulf state. There is no longer a federal season; a state's regulations apply to vessels registered in that state whether fishing in that state's or federal waters.

\*\*\*The 2020 and subsequent fishing seasons for private anglers will be managed by each Gulf state under Reef Fish Amendment 50. There is no longer a federal season; a state's regulations apply to vessels registered in that state, whether fishing in that state's waters or federal waters.

^ Texas has separate seasons for state and federal waters. State waters are open year-round, while federal waters are open based on the state's allocation through Amendment 50.

TBD: For MS and LA in 2020, the season opening day (May 22) has been announced, but not the season closure date, which will occur when the state's quota is met, as landings are monitored in-season.

Rec For-Hire Fishing Season				
Year	Actual ACL	Actual ACT	Closure	Days open
2015	2,279,970 after Am 40 then 2,964,000 after Framework	1,824,000 after Am 40 then 2,371,000 after Framework	7/15/15	44
2016	2,893,000 then 3,042,000	2,315,000 then 2,434,000	7/17/16	46
2017	2,993,000 then 2,848,000	2,395,000 then 2,278,000	7/20/17	49
2018	2,848,000	2,278,000	7/22/18	51
2019	3,130,000	2,848,000	8/2/19	62
2020	3,130,000	2,848,000	8/2/20	62
2021	3,130,000	2,848,000	8/3/2021; reopen 9/15/2021; reclose 11/6/2021	84 (63 + 21)
2022	3,130,000	2,848,000	8/19/22	79
2023	3,191,958	2,904,862	8/25/23	85

### 3 ASSESSMENT HISTORY AND REVIEW

Management of Red Snapper in the U.S. Gulf of Mexico began in 1984 with the implementation of the Gulf of Mexico Fishery Management Council Reef Fish Fishery Management Plan (Goodyear 1995). At that time, no formal assessment of the population dynamics of Gulf of Mexico Red Snapper had been conducted. However, early studies did include analyses of yield per recruit (Waters and Huntsman 1984); and the fitting of production models to historical catch and effort data over restricted geographical regions (Gazey and Gallaway 1980).

Routine assessments of Gulf of Mexico Red Snapper began in the mid-1980s. These early assessments first sought to describe the biological and biometric characteristics of Red Snapper (Parrack 1986b) as well as trends in catch, effort, catch per unit effort (CPUE) and catch-at-size (Cummings and Chewning 1986, Parrack and McClellan 1986). Management advice, including estimates of fishing mortality and spawning stock biomass (SSB) were developed using age-structured Virtual Population Analyses (VPA) and other techniques. The results indicated important declines in stock production, as well as adult and recruiting population sizes during 1979-1985.

Similar annual assessments of Gulf of Mexico Red Snapper that used VPA and yield per recruit analyses to develop management advice were conducted by Goodyear (e.g. 1987, 1988, 1992, 1993, 1994, 1995), Phares and Goodyear (1990a, 1990b), Schirripa and Legault (1997) and Schirripa (1998). These assessments share similar outcomes, that fishing mortality by directed fisheries was higher than recommended, that Spawning Potential Ratio (SPR) was a small fraction of unfished levels, and that shrimp bycatch should be reduced significantly to facilitate the recovery to target levels with a high probability (>50%) of success. These assessments also introduced forecasts of future yield and SPR under various management scenarios, including catch quotas and elimination of shrimp discard mortality (e.g. Goodyear 1995).

In 1999, the Red Snapper stock assessment was transitioned to a new stock assessment method, the Age Structured Assessment Program (ASAP, Legault and Restrepo 1998). Like previous VPA models used to assess Red Snapper, ASAP was based on separating fishing effects by different gears into year and age components. However, the ASAP model represented advancement because it allowed for changes in selectivity and catchability over time, and did not require gear specific catch-at-age for all years. The data inputs, model parameterization and results are thoroughly described in Schirripa and Legault (1999). Like previous assessments of Red Snapper, the 1999 ASAP assessment model indicated that the stock was undergoing overfishing relative to all F references considered (FMSY, FMAX, FSPR20%, F0.1). The stock was also overfished relative to the SPR corresponding to the MSY (SPR20%). During that assessment, analyses were also conducted to determine which combinations of reductions in directed fishing and/or shrimp bycatch would allow stock recovery before 2019 (to SPR20%) or 2034 (to SPR26%).

Several population models were used to assess the status of Red Snapper in 2005 (SEDAR 7), including VPA, ASAP, CATCHEM and Stock Reduction Analysis (SRA). The ASAP model had been used in the most recent assessment (Schirripa and Legault 1999), but exhibited instability when used to address the very long time series (1872-2003) and to a lesser extent with the shorter time series (1962-2003 and 1984-2003). A newly developed program CATCHEM was created, in part, to enable use of the historical time series information, and to be able to model fish discarded due to a minimum size internally as opposed to the external manner in which discard estimates have been made in past Red Snapper assessments (as part of the probabilistic aging procedure). Ultimately, the SEDAR 7 Review Workshop panel recommended the use of CATCHEM to develop management advice for Red Snapper. A full description of the CATCHEM model can be found in SEDAR7 Assessment Workshop (SEDAR 2005) or in Porch (2007). Briefly, the CATCHEM algorithm is a statistical catch-at-age model that was applied to information on Red Snapper populations in U.S. waters during the years from 1872 to 2004.

Like previous assessments, the 2005 CATCHEM model also indicated the stock was overfished, and undergoing overfishing. Projections indicated that the existing Total Allowable Catch (TAC) of 9.12 million lbs. was sustainable with a severe reduction in shrimp bycatch, but the spawning stock was expected to remain well below SSBMSY (current-shrimp effort). On the other hand, the spawning stock was projected to recover to the SSBMSY (current-shrimp effort) reference in less than ten years in the absence of any directed harvest. Other combinations of reductions in directed fishing and/or shrimp bycatch were expected to allow recovery to SPR26% by 2032.

The SEDAR 7 assessment was updated using CATCHEM in 2009. A description of that assessment can be found in SEDAR (2009). The Update Review panel and the GMFMC SSC recommended the use of the AS3 model, as described in SEDAR (2009) to develop management advice. According to that model the stock was overfished ( $SSB/MSST = 0.19$ ) and undergoing overfishing ( $F/MFMT = 1.9$ ). An unexpected and severe reduction in shrimp effort occurred following the 2005 assessment due to hurricane damage and economic factors (i.e. 75% reduction from 2001-2003 levels). In fact, the reduction in shrimp effort in 2008 was even greater than what was called for in the Red Snapper rebuilding plan. Therefore, additional reductions in shrimp effort were no longer necessary to rebuild the Red Snapper stock. In fact,

the projections used to develop the Overfishing Limit (OFL) and Acceptable Catch Target (ACT) assumed that shrimp effort would rebuild to some extent.

The SEDAR 31 benchmark assessment (2013) transitioned modeling environments from CATCHEM to Stock Synthesis (SS). Other substantial modifications included the integration of depth-related discard mortality rates by sector, integration of the Marine Recreational Information Program (MRIP) into the recreational landings data, and the utilization of remotely operated vehicle (ROV) derived age composition surveys. The SEDAR 31 benchmark assessment indicated that gulfwide SSB had increased since the previous assessment; however, the stock remained overfished (SSB/MSST = 0.4). Notably, the benchmark assessment indicated that overfishing was no longer occurring (F/MFMT = 0.69). Comparisons between modeling platforms (SS and CATCHEM) were completed to ensure that any changes in model fit and subsequent stock status were not the result of changes in modeling platform alone.

The SS modeling platform was used again during an update to the SEDAR 31 benchmark assessment completed in 2015. A description of that assessment can be found in SEDAR (2015). The update assessment retained the base model configuration from SEDAR 31 except for the addition of a selectivity time block (2011-2013), which was added to all recreational fleets to accommodate a perceived change in recent fishing behavior. The model estimated there to have been continued growth in gulfwide SSB; however the stock remained overfished (SSB/MSST = 0.593). As was the case during the benchmark assessment, overfishing was determined to have not been occurring in the terminal assessment year (F/MFMT = 0.994).

The SEDAR 52 standard assessment was completed in 2018 and was built off of the two-area SS modeling framework established during the SEDAR 31 update assessment. A complete description of SEDAR 52 can be found in SEDAR (2018). Briefly, the SEDAR 52 base model performed well and improved some minor deficiencies in data inputs and model settings from the 2014 SEDAR 31 Update Assessment (SEDAR 2015). Changes in data inputs included: new recommended methodology for calculating observed discards for the commercial and recreational headboat fleets; truncated recreational CPUE indices; an updated estimate of recreational discard mortality; and general updates to each of the data sets to reflect the new terminal year of 2016. Minor changes to the assessment model included: rescaling of input index standard errors to a common mean of 0.2 to avoid undue influence of any single index; reweighting the age composition effective sample sizes to avoid overfitting the age data at the expense of other data inputs; and the reparametrization of many of the selectivity functions from a random walk by age to a double normal. Although none of the changes appeared to have a large impact on population estimates and trajectories, it is believed that each improved the overall performance and reliability of the assessment.

Overall, the SEDAR 52 model corroborated and agreed with many of the estimates and projections from the 2014 SEDAR 31 Update Assessment. The Gulf of Mexico Red Snapper resource was estimated to have continued rebuilding from the previous assessment, increasing from 0.14 to a 2016 terminal year SPR of 0.18. Due to a change in MSST the stock was determined to no longer be overfished; however, the terminal SPR remained below the target of 0.26 requiring the stock to continue being managed under its established rebuilding plan. Overfishing was estimated to no longer be occurring with a terminal year F ratio of 0.823. The

model indicated that further Gulf of Mexico wide rebuilding was likely; however, projections demonstrated opposing trends in area population sizes with the eastern area expected to decline rapidly, while the western area continued to steadily rebuild. The differences in area may have been the result of imperfect projection assumptions, but the eastern area may warrant careful monitoring during future assessment cycles.

The following is a chronological list of selected stock assessment documents pertaining to Gulf of Mexico Red Snapper:

- Gazey, W. and B. J. Gallaway. 1980. Population dynamics of the red snapper (*Lutjanus campechanus*) in the northwestern Gulf of Mexico. Progress report to NMFS, SEFC, Galveston Laboratory, Galveston, Texas. Contract NA 80-GA-C-00057. 27 p.
- Waters, J. and G. Huntsman. 1984. Incorporating catch and release mortality into yield-per-recruit analyses of minimum size limits. A summary of work performed for the Gulf of Mexico Fishery Management Council, 35 p.
- Cummings, N. C. and T. W. Chewning. 1986. Recent catch and catch per unit of effort of the Gulf of Mexico red snapper and grouper fisheries. NOAA, NMFS. SEFC, Miami Laboratory, Coastal Res. Div. CRD. Prepared for Gulf of Mexico Fishery Management Council, March 1986. 36 p.
- Parrack, N. C. and D. B. McClellan. 1986. Trends in Gulf of Mexico Red Snapper Population Dynamics, 1979-85. National Marine Fisheries Service, Southeast Fisheries Science Center, Miami Laboratory, Miami CRD-86/87-4.
- Parrack, N. C. 1986b. Review and update of Gulf of Mexico red snapper biometrics: 1. Length-weight relations, 2. length-length conversions. National Marine Fisheries Service, Southeast Fisheries Science Center, Miami Laboratory, Miami CRD-86/87-3.
- Goodyear, C.P. 1987. Recent trends in the red snapper fishery of the Gulf of Mexico. National Marine Fisheries Service, Southeast Fisheries Center, Miami Laboratory, Miami CRD-87/88-16.
- Goodyear, Phillip C. 1988. Recent trends in the Red Snapper Fishery of the Gulf of Mexico. CRD 87/88-16 CRD.
- Goodyear, Phillip C. and Patricia Phares. 1990. Status of Red Snapper stocks of the Gulf of Mexico Report for 1990. CRD 89/90-05 CRD.
- Goodyear, Phillip C. and Patricia Phares. 1990. Addendum Status of Red Snapper stocks of the Gulf of Mexico Report for 1990. CRD 89/90-05A CRD.
- Goodyear, C. Phillip. 1992. Red Snapper in U.S. Waters of the Gulf of Mexico. MIA- 91/92-70, 156 p. MIA.
- Goodyear, C. Phillip. 1993. Red Snapper in U.S. Waters of the Gulf of Mexico 1992 Assessment Update. MIA-92/93-76, 125 p. MIA.
- Goodyear, C. Phillip. 1994. Red Snapper in U.S. Waters of the Gulf of Mexico. MIA 93/94-63, 160 p. MIA.
- Goodyear, C. Phillip. 1995. Red Snapper in U.S. Waters of the Gulf of Mexico. MIA- 95/96-05, 171 p. MIA.
- Goodyear, C. Phillip. 1996. An Update of Red Snapper Harvest in U.S. Waters of the Gulf of Mexico. MIA-95/96-60, 21 p. MIA.

- Schirripa, Michael J. and Christopher M. Legault. 1997. Status of Red Snapper in U.S. Waters of the Gulf of Mexico: Updated Through 1996. MIA-97/98-05, 40 p. MIA.
- Schirripa, Michael J. 1998. Status of the Red Snapper in U.S. Waters of the Gulf of Mexico: Updated Through 1997. SFD-97/98-30, 85 p. SFD.
- Legault, Christopher M. and Victor R. Restrepo. 1998. A Flexible Forward Age- Structured Assessment Program. SFD-98/99-16, 15 p. SFD.
- Schirripa, Michael J. and Christopher M. Legault. 1999. Status of Red Snapper in the U.S. Gulf of Mexico: Updated Through 1998. SFD-99/00-75, 86 p. SFD.
- SEDAR 2005. Southeast Data, Assessment, and Review: Stock Assessment Report of SEDAR 7: Gulf of Mexico Red Snapper. SEDAR 7. One Southpark Circle #306, Charleston, SC 29414
- Porch CE. 2007. An assessment of the red snapper fishery in the U.S. Gulf of Mexico using a spatially-explicit age-structured model. In: Patterson WF, Cowan JH Jr, Fitzhugh GR, Nieland DL (eds) Red Snapper ecology and fisheries in the US Gulf of Mexico. American Fisheries Society, Symposium 60, Bethesda, Maryland, pp 355–384.
- SEDAR 2009. Stock Assessment of Red Snapper in the Gulf of Mexico. SEDAR Assessment Update. Report of the Update Assessment Workshop, Miami, Florida, August 24–28, 2009.
- SEDAR. 2013. SEDAR 31 - Gulf of Mexico Red Snapper Stock Assessment Report. SEDAR, North Charleston SC. 1103 pp.
- SEDAR. 2015. Stock Assessment of Red Snapper in the Gulf of Mexico 1872 – 2013 – with Provisional 2014 Landings. SEDAR 31 Update Assessment, North Charleston SC. 242 pp.
- SEDAR. 2018. SEDAR 52 – Gulf of Mexico Red Snapper Stock Assessment Report. SEDAR, North Charleston SC. 434 pp.



#### 4 REGIONAL MAPS

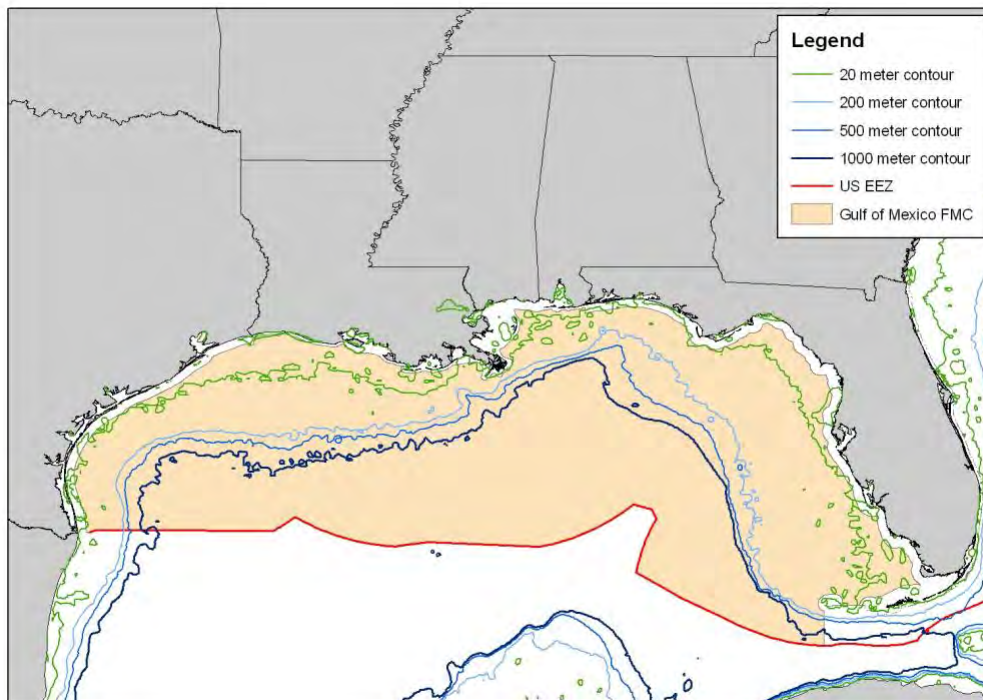


Figure 4.1 Southeast Region including Council and EEZ Boundaries.

#### 5 SEDAR ABBREVIATIONS

ABC	Acceptable Biological Catch
ACCSP	Atlantic Coastal Cooperative Statistics Program
ADMB	AD Model Builder (software program)
ALS	Accumulated Landings System: SEFSC fisheries data collection program
AMRD	Alabama Marine Resources Division
APAIS	Access Point Angler Intercept Survey
ASMFC	Atlantic States Marine Fisheries Commission
B	Biomass (stock) level
BAM	Beaufort Assessment Model
B <sub>msy</sub>	B capable of producing MSY on a continuing basis
BSIA	Best Scientific Information Available
CHTS	Coastal Household Telephone Survey
CFMC	Caribbean Fishery Management Council
CIE	Center for Independent Experts
CPUE	Catch Per Unit Effort

EEZ	Exclusive Economic Zone
F	Fishing mortality (instantaneous)
FES	Fishing Effort Survey
FIN	Fisheries Information Network
$F_{MSY}$	F to produce MSY under equilibrium conditions
$F_{OY}$	F rate to produce OY under equilibrium
$F_{XX\% SPR}$	F rate resulting in retaining XX% of the maximum spawning production under equilibrium conditions
$F_{max}$	F maximizing the average weight yield per fish recruited to the fishery
$F_o$	F close to, but slightly less than, $F_{max}$
FL FWCC	Florida Fish and Wildlife Conservation Commission
FWRI	Florida Fish and Wildlife Research Institute
GA DNR	Georgia Department of Natural Resources
GLM	General Linear Model
GMFMC	Gulf of Mexico Fishery Management Council
GSMFC	Gulf States Marine Fisheries Commission
GULF FIN	GSMFC Fisheries Information Network
HMS	Highly Migratory Species
LDWF	Louisiana Department of Wildlife and Fisheries
M	natural mortality (instantaneous)
MARFIN	Marine Fisheries Initiative
MARMAP	Marine Resources Monitoring, Assessment, and Prediction
MDMR	Mississippi Department of Marine Resources
MFMT	Maximum Fishing Mortality Threshold: value of F above which overfishing is deemed to be occurring
MRFSS	Marine Recreational Fisheries Statistics Survey: combines a telephone survey of households to estimate number of trips with creel surveys to estimate catch and effort per trip
MRIP	Marine Recreational Information Program
MSA	Magnuson Stevens Act
MSST	Minimum Stock Size Threshold: value of B below which the stock is deemed to be overfished
MSY	Maximum Sustainable Yield
NC DMF	North Carolina Division of Marine Fisheries
NMFS	National Marine Fisheries Service
NOAA	National Oceanographic and Atmospheric Administration
OST	Office of Science and Technology, NOAA
OY	Optimum Yield
SAFMC	South Atlantic Fishery Management Council
SC DNR	South Carolina Department of Natural Resources

SEAMAP	Southeast Area Monitoring and Assessment Program
SEDAR	Southeast Data, Assessment and Review
SEFIS	Southeast Fishery-Independent Survey
SEFSC	Southeast Fisheries Science Center, NMFS
SERFS	Southeast Reef Fish Survey
SERO	Southeast Regional Office, NMFS
SRFS	State Reef Fish Survey (Florida)
SRHS	Southeast Region Headboat Survey
SPR	Spawning Potential Ratio: B relative to an unfished state of the stock
SSB	Spawning Stock Biomass
SS	Stock Synthesis
SSC	Scientific and Statistical Committee
TIP	Trip Incident Program: biological data collection program of the SEFSC and Southeast States
TPWD	Texas Parks and Wildlife Department
Z	total mortality (M+F)



# SEDAR

Southeast Data, Assessment, and Review

---

## SEDAR 74

### Gulf of Mexico Red Snapper Stock ID Process Final Report

**Original Release: August 2021**

**Revised: October 2021**

**Revised: November 2021**

SEDAR  
4055 Faber Place Drive, Suite 201  
North Charleston, SC 29405

Document History:

August 20, 2021 Original Release

October 28, 2021 Revision

The report was re-released with modified language to clarify the intent of the CPUE and Landings Working Group section.

In the executive summary

Stock Option Summaries  
Option C  
Text changed from

A three-unit stock that maintains the current boundary at the Mississippi river outflow (statistical zone 12/13) and adds an additional split east of Cape San Blas, FL and slightly north of Tampa (statistical zones 7/8). Option C was proposed as a proxy for the preferred split at Cape San Blas, FL. This option locates the boundary at the nearest point to the east of Cape San Blas, FL that the recreational data resolution would allow (See Appendix C for further details).

To

A three-unit stock that maintains the current boundary at the Mississippi river outflow (statistical zone 12/13) and adds an additional split east of Cape San Blas, FL and slightly north of Tampa (statistical zones 7/6). Option C was proposed as a proxy for the preferred split at Cape San Blas, FL. This option locates the boundary at the nearest point to the east of Cape San Blas, FL that the recreational data resolution would allow (See Appendix C for further details).

This was done to correct an error in the statistical zones identifying the boundary location north of Tampa (highlighted above)

---

## Correction 2

In the Landings and CPUE section of the executive summary

The following text was changed from

Given the above findings, the recommendation from the landings and CPUE working group was for a three-stock model with the primary boundary located at the Mississippi River (between statistical zones 12/13) and a secondary boundary at or near Cape San Blas, FL (statistical zones 7/8). The proposed boundaries allow for the separation and modeling of fisheries dynamics evident in the presented data. These boundaries also create problems for the assessment for two reasons: 1) small sample sizes for all size composition data, and 2) only able to reliably separate Alabama from NWFL in the SRHS data since 2013. Moving the 2<sup>nd</sup> boundary east to the Big Bend region (statistical zones 7/6) was a suggested compromise as it would not require the separation of AL from NWFL in the SRHS data but would still have sample size issues across all data sources.

To

Given the above findings, the recommendation from the landings and CPUE working group were either a two-stock model with a boundary at statistical zones (9/10), or a three-stock model with the primary boundary located at the Mississippi River (between statistical zones 12/13) and a secondary boundary at or near Cape San Blas, FL (statistical zones 7/8). The proposed boundaries allow for the separation and modeling of fish biology and fisheries dynamics evident in the presented data. The suggested boundaries at 9/10 and/or 7/8 are likely to create issues for the assessment for two reasons: 1) small sample sizes for all size composition data, and 2) only able to reliably separate Alabama from NWFL in the SRHS data since 2013. Moving the secondary boundary at Cape San Blas, FL (7/8) east to the Big Bend region (statistical zones 7/6) was a suggested compromise as it would not require the separation of AL from NWFL in the SRHS data but would still have sample size issues across all data sources.

Changes were made to clarify the conclusion of the Landings and CPUE working group following additional discussions that occurred after the initial report was submitted.

November 2, 2021      Revision

#### **Document History: Landings and CPUE Working Group**

- The executive summary was changed to accurately reflect the workgroup's summary findings
- Any language referencing a consensus recommendation was removed from the report
- The report section was reorganized to improve flow and readability
  - Moved the "Length Compositions of Landings" section before the "Discussion" section (no changes to text within)
  - Moved Figure 11 to be the new Figure 3 (and updated subsequent figure references)
- Years 2012-2019 were added to Table 5, to ensure that all the data was presented
- Reference to Figure 4 in the "Reef Fish Video Surveys" section was updated to Figure 10 to correctly identify the relevant figure

**Table of Contents**

Table of Contents .....	4
1 INTRODUCTION .....	5
1.1 WORKSHOP TIME AND PLACE .....	5
1.2 TERMS OF REFERENCE .....	5
1.3 LIST OF PARTICIPANTS.....	6
1.4 LIST OF STOCK ID PROCESS WORKSHOP WORKING PAPERS AND DOCUMENTS.....	7
2 STOCK ID PANEL REPORT .....	18
2.1 EXECUTIVE SUMMARY .....	18
2.1.1 Stock Option Summaries .....	22
2.1.2 Assessment Unit Stock Recommendation .....	23
2.2 LIFE HISTORY WORKING GROUP .....	25
2.2.1 Life History Working Group Executive Summary .....	26
2.2.2 Age, Growth and Reproduction .....	26
2.2.3 Movement .....	29
2.2.4 Additional Considerations .....	32
2.2.5 Tables .....	32
2.2.6 Figures.....	34
2.2.7 References.....	42
2.3 GENETICS WORKING GROUP .....	44
2.3.1 Literature and Data Review and Evaluation .....	44
2.3.2 Group conclusions .....	50
2.4 LANDINGS AND CPUE WORKING GROUP .....	51
2.4.1 Landings and CPUE Working Group Executive Summary .....	52
2.4.2 General Recreational Landings .....	54
2.4.3 Southeast Region Headboat Survey (SRHS) .....	54
2.4.4 Reef Fish Video Surveys .....	55
2.4.5 Length Compositions of Landings .....	56
2.4.6 Discussion .....	57
2.4.7 Tables .....	59

2.4.8	Figures.....	64
3	APPENDICES .....	73
3.1	Appendix A: SEDAR 74 Red Snapper Stock ID Option A.....	73
3.2	Appendix B: SEDAR 74 Red Snapper Stock ID Option B .....	78
3.3	Appendix C: SEDAR 74 Red Snapper Stock ID Option C .....	82

## 1 INTRODUCTION

### 1.1 WORKSHOP TIME AND PLACE

The SEDAR 74 Scamp Stock ID Process was conducted via a series of webinars between November 2020 and July 2021, including a data scoping webinar and three discussion webinars to review data and analysis.

### 1.2 TERMS OF REFERENCE

Process Goal: Review Gulf of Mexico stock structure and unit stock definitions and consider whether changes are required.

1. Review relevant information on population structure. Potential sources include genetic studies, growth patterns, movement and migration, existing stock definitions, otolith chemistry, oceanographic and habitat characteristics, and hotspot maps of landings or CPUE.
2. Make recommendations on biological stock structure and the assessment unit stock or stocks to be addressed through SEDAR 74 and document the rationale behind the recommendations. The default boundaries for assessments should be the current Council boundaries between the Gulf of Mexico and South Atlantic, and the boundary used in previous assessments to divide the eastern (shrimp grids 1-12) and western (shrimp grids 13-21) Gulf of Mexico. If there is reasonable evidence for deviating from these boundaries, an accompanying recommendation on spatial considerations for management should also be provided.
3. Discuss the strength of evidence in support of stock ID recommendations with particular attention paid to recommendations if they result in a mismatch of biological stock structure, assessment unit stock, and existing management boundaries.
4. Provide recommendations for future research on stock structure.
5. Prepare a report providing complete documentation of workshop recommendations and decisions.



## 1.3 LIST OF PARTICIPANTS

Jason Adriance .....	SSC/LA WLF
Robert Allman.....	NMFS Panama City
Kevin Anson .....	AL DCNR
Beverly Barnett .....	NMFS Panama City
Steve Bortone.....	Osprey Aquatic Sciences LLC
Ken Brennan .....	NMFS Beaufort
Nancy Brown-Peterson .....	USM
Steve Cadrin.....	UMASS Dartmouth
Matt Campbell .....	SEFSC Pascagoula
Jessica Carroll .....	FL FWC
Matt Catalano.....	Auburn
Judd Curtis .....	SSC/TAMUCC
Michal Dance .....	LSU
LaTresse Denton (Co-Lead Analyst).....	NMFS Miami
Marcus Drymon (Life History Working Group Lead) .....	SSC/MSU
Kelly Fitzpatrick .....	SEFSC Beaufort
Kerry Flaherty Walia .....	FL FWC
Benny Gallaway.....	SSC/ LGL Ecological Associates
Steve Garner.....	NOAA NMFS
Jay Grove .....	NOAA NMFS
David Hanisko .....	NMFS Pascagoula
Mandy Karnauskas.....	NMFS Miami
Susan Lowerre-Barbieri .....	FL FWC
John Mareska .....	SSC/AL DCNR
Vivian Matter .....	SEFSC Miami
Kevin McCarthy.....	NMFS Miami
Trevor Moncrief.....	MS DMR
Peter Mudrak.....	LGL Ecological Associates
Matthew Nuttall .....	SEFSC Miami
Refik Orhun .....	SEFSC Miami
Katherine Overly.....	NMFS Panama City
Dave Portnoy .....	TAMU CC
Will Patterson.....	SSC/UFL
Adam Pollack.....	NMFS Pascagoula
Sean Powers .....	SSC/DISL
Nathan Putman.....	LGL Ecological Associates
Skyler Sagarese.....	NMFS Miami
Eric Saillant (Genetics Working Group Lead).....	USM
Steven Scyphers .....	SSC/Northeastern University
Kate Siegfried .....	SEFSC Miami
Matt Smith (Co-Lead Analyst) .....	NMFS Miami
Molly Stevens .....	NMFS Miami
Matt Streich.....	TAMUCC
Ted Switzer .....	FL FWCC
Kevin Thompson.....	FL FWCC

Jim Tolan (Landings and CPUE Working Group Lead) .....GMFMC SSC  
 Darin Topping ..... TPWD  
 Ana Vaz .....NOAA

**Attendees**

Kristan Blackhart ..... NOAA  
 Alisha Gray DiLeone ..... NOAA SERO  
 Michal Drexler ..... Ocean Conservancy  
 Eric Gigli ..... MS DNR  
 Rich Malinowski ..... NOAA  
 Isabella Masarik ..... NOAA  
 Jeremy Timbs ..... MS DMR  
 Adrian Zuniga .....

**Staff**

Julie Neer ..... SEDAR  
 Jeff Pulver ..... SERO  
 Ryan Rindone ..... GMFMC Staff

1.4 LIST OF STOCK ID PROCESS WORKSHOP WORKING PAPERS AND DOCUMENTS

Document #	Title	Authors	Date Submitted
<b>Documents Prepared for the Stock ID Process</b>			
SEDAR74-SID-01	Hot Spot Maps of General Recreational Landings for Gulf of Mexico Red Snapper	Matthew A. Nuttall and Vivian M. Matter	25 February 2021
SEDAR74-SID-02	A Lagrangian biophysical modeling framework informs stock structure and spawning-recruitment of red snapper ( <i>Lutjanus campechanus</i> ) in the northern Gulf of Mexico	M. Karnauskas and C. B. Paris	12 March 2021
SEDAR74-SID-03	Insights into the Spatial Dynamics of Red Snapper in the Gulf of Mexico from Gulf-Wide Fishery Independent Surveys	Theodore S. Switzer, Adam G. Pollack, Katherine E. Overly, Christopher Gardner, Kevin A.	15 March 2021

		Thompson, Matt Campbell	
SEDAR74-SID-04	Mississippi Red Snapper Data Summary	Trevor Moncrief	12 March 2021
SEDAR74-SID-05	Spatial analysis of Southeast Regional Headboat Survey Catch Records	Nikolai Klibansky	29 July 2021
SEDAR74-SID-06	Some thoughts on dividing the northern Gulf of Mexico red snapper stock into eastern and western components at the statistical area 9/10 border	Benny J. Gallway and Peter A. Mudrak	30 July 2021
<b>Reference Documents</b>			
SEDAR74-RD01	Data Availability for Red Snapper in Gulf of Mexico and Southeastern U.S. Atlantic Ocean Waters	R. Ryan Rindone, G. Todd Kellison & Stephen A. Bortone	
SEDAR74-RD02	Fine-Scale Movements and Home Ranges of Red Snapper around Artificial Reefs in the Northern Gulf of Mexico	Maria N. Piraino & Stephen T. Szedlmayer	
SEDAR74-RD03	Influence of Age-1 Conspecifics, Sediment Type, Dissolved Oxygen, and the Deepwater Horizon Oil Spill on Recruitment of Age-0 Red Snapper in the Northeast Gulf of Mexico during 2010 and 2011	Stephen T. Szedlmayer & Peter A. Mudrak	
SEDAR74-RD04	Depth and Artificial Reef Type Effects on Size and Distribution of Red Snapper in the Northern Gulf of Mexico	J. Jaxion-Harm & S. T. Szedlmayer	
SEDAR74-RD05	A cage release method to improve fish tagging studies	Laura Jay Williams*, Jennifer L. Herbig, Stephen T. Szedlmayer	

SEDAR74-RD06	Mortality Estimates for Red Snapper Based on Ultrasonic Telemetry in the Northern Gulf of Mexico	Laura Jay Williams-Grove & Stephen T. Szedlmayer
SEDAR74-RD07	Acoustic positioning and movement patterns of red snapper <i>Lutjanus campechanus</i> around artificial reefs in the northern Gulf of Mexico	Laura Jay Williams-Grove & Stephen T. Szedlmayer
SEDAR74-RD08	Depth preferences and three-dimensional movements of red snapper, <i>Lutjanus campechanus</i> , on an artificial reef in the northern Gulf of Mexico	Laura Jay Williams-Grove & Stephen T. Szedlmayer
SEDAR74-RD09	A Comparison of Fish Assemblages According to Artificial Reef Attributes and Seasons in the Northern Gulf of Mexico	J. Jaxion-Harm, S. T. Szedlmayer & P.A. Mudrak
SEDAR74-RD10	A Comparison of Fish and Epibenthic Assemblages on Artificial Reefs with and without Copper-Based, Anti-Fouling Paint	Stephen T. Szedlmayer & Dianna R. Miller
SEDAR74-RD11	Movement patterns of red snapper <i>Lutjanus campechanus</i> based on acoustic telemetry around oil and gas platforms in the northern Gulf of Mexico	Aminda G. Everett, Stephen T. Szedlmayer, Benny J. Gallaway
SEDAR74-RD12	Changes in Shrimping Effort in the Gulf of Mexico and the Impacts to Red Snapper	Benny J. Gallaway, Scott W. Raborn, Laura Picariello, and Nathan F. Putman
SEDAR74-RD13	Using Common Age Units to Communicate the Relative Catch of Red Snapper in Recreational, Commercial, and Shrimp Fisheries in the Gulf of Mexico	Nathan F. Putman & Benny J. Gallaway
SEDAR74-RD14	Distribution and Age Composition of Red Snapper across the Inner	Sean P. Powers, J. Marcus Drymon, <sup>1</sup> Crystal L. Hightower,

	Continental Shelf of the North-Central Gulf of Mexico	Trey Spearman, George S. Bosarge, and Amanda Jefferson
SEDAR74-RD15	Age and growth of red snapper, <i>Lutjanus campechanus</i> , from an artificial reef area off Alabama in the northern Gulf of Mexico	William F. Patterson III, James H. Cowan Jr, Charles A. Wilson, and Robert L. Shipp
SEDAR74-RD16	Red snapper ( <i>Lutjanus campechanus</i> ) demographic structure in the northern Gulf of Mexico based on spatial patterns in growth rates and morphometrics	Andrew J. Fischer, M. Scott Baker Jr., and Charles A. Wilson
SEDAR74-RD17	Temporal Age Progressions and Relative Year-Class Strength of Gulf of Mexico Red Snapper	Robert J. Allman and Gary R. Fitzhugh
SEDAR74-RD18	Age structure of red snapper ( <i>Lutjanus campechanus</i> ) in the Gulf of Mexico by fishing mode and region	Robert J. Allman, Linda A. Lombardi-Carlson, Gary R. Fitzhugh, and William A. Fable
SEDAR74-RD19	Regional differences in the age and growth of red snapper ( <i>Lutjanus campechanus</i> ) in the U.S. Gulf of Mexico	Courtney R. Saari, James H. Cowan Jr., and Kevin M. Boswell
SEDAR74-RD20	A Comparison of Size Structure, Age, and Growth of Red Snapper from Artificial and Natural Habitats in the Western Gulf of Mexico	Matthew K. Streich, Matthew J. Ajemian, Jennifer J. Wetz, Jason A. Williams, J. Brooke Shipley & Gregory W. Stunz
SEDAR74-RD21	A comparison of size and age of red snapper ( <i>Lutjanus campechanus</i> ) with the age of artificial reefs in the northern Gulf of Mexico	Tara S. Syc and Stephen T. Szedlmayer
SEDAR74-RD22	Age and growth of red snapper, <i>Lutjanus campechanus</i> , from the northern Gulf of Mexico off Louisiana	Charles A. Wilson and David L. Nieland

SEDAR74-RD23	Cross-shelf habitat shifts by red snapper ( <i>Lutjanus campechanus</i> ) in the Gulf of Mexico	Michael A. Dance and Jay R. Rooker
SEDAR74-RD24	Habitat-Specific Reproductive Potential of Red Snapper: A Comparison of Artificial and Natural Reefs in the Western Gulf of Mexico	Charles H. Downey, Matthew K. Streich, Rachel A. Brewton, Matthew J. Ajemian, Jennifer J. Wetz, and Gregory W. Stunz
SEDAR74-RD25	A meta-analytical review of the effects of environmental and ecological drivers on the abundance of red snapper ( <i>Lutjanus campechanus</i> ) in the U.S. Gulf of Mexico	Brad E. Erisman, Derek G. Bolser, Alexander Ilich, Kaitlin E. Frasier, Cassandra N. Glaspie, Paula T. Moreno, Andrea Dell’Apa, Kim de Mutsert, Mohammad S. Yassin, Sunil Nepal, Tingting Tang, Alexander E. Sacco
SEDAR74-RD26	Daily movement patterns of red snapper ( <i>Lutjanus campechanus</i> ) on a large artificial reef	Catheline Y.M. Froehlich, Andres Garcia, and Richard J. Kline
SEDAR74-RD27	Movement of Tagged Red Snapper in the Northern Gulf of Mexico	William F. Patterson III, J. Carter Watterson, Robert L. Shipp & James H. Cowan Jr.
SEDAR74-RD28	Did the Deepwater Horizon oil spill affect growth of Red Snapper in the Gulf of Mexico?	Elizabeth S. Herdter, Don P. Chambers, Christopher D. Stallings, and Steven A. Murawski
SEDAR74-RD29	Red Snapper Distribution on Natural Habitats and Artificial Structures in the Northern Gulf of Mexico	Mandy Karnauskas, John F. Walter III, Matthew D. Campbell, Adam G. Pollack, J. Marcus Drymon & Sean Powers
SEDAR74-RD30	Comparison of Reef-Fish Assemblages between Artificial and Geologic Habitats in the Northeastern Gulf of Mexico: Implications for Fishery-Independent Surveys	Sean F. Keenan, Theodore S. Switzer, Kevin A. Thompson, Amanda J. Tyler-Jedlund, and Anthony R. Knapp

SEDAR74-RD31	Estimating Exploitation Rates in the Alabama Red Snapper Fishery Using a High-Reward Tag–Recapture Approach	Dana K. Sackett, Matthew Catalano, Marcus Drymon, Sean Powers, and Mark A. Albins
SEDAR74-RD32	Spatial Heterogeneity, Variable Rewards, Tag Loss, and Tagging Mortality Affect the Performance of Mark–Recapture Designs to Estimate Exploitation: an Example using Red Snapper in the Northern Gulf of Mexico	Dana K. Sackett and Matthew Catalano
SEDAR74-RD33	Modeling the spatial distribution of commercially important reef fishes on the West Florida Shelf	S.E. Saul, J.F. Walter III, D.J. Die, D.F. Naar, B.T. Donahue
SEDAR74-RD34	Descriptions of the U.S. Gulf of Mexico Reef Fish Bottom Longline and Vertical Line Fisheries Based on Observer Data	Elizabeth Scott-Denton, Pat F. Cryer, Judith P. Gocke, Mike R. Harrelson, Donna L. Kinsella, Jeff R. Pulver, Rebecca C. Smith, and Jo Anne Williams
SEDAR74-RD35	The potential for unreported artificial reefs to serve as refuges from fishing mortality for reef fishes	Dustin T. Addis, William F. Patterson III, Michael A. Dance, and G. Walter Ingram Jr.
SEDAR74-RD36	Immature and mature female Red Snapper habitat use in the north-central Gulf of Mexico	A.J. Leontiou, Wei Wu, and Nancy J. Brown-Peterson
SEDAR74-RD37	Importance of Depth and Artificial Structure as Predictors of Female Red Snapper Reproductive Parameters	Nancy J. Brown-Peterson, Robert T. Leaf, and Andrea J. Leontiou
SEDAR74-RD38	Demographic differences in northern Gulf of Mexico red snapper reproductive maturation	Melissa W. Jackson, James, H. Cowan, Jr. and David L. Nieland

SEDAR74-RD39	Estimating the Dependence of Spawning Frequency on Size and Age in Gulf of Mexico Red Snapper	C. E. Porch, G. R. Fitzhugh, E. T. Lang, H. M. Lyon & B. C. Linton
SEDAR74-RD40	Regional Differences in Florida Red Snapper Reproduction	Nancy J. Brown-Peterson, Karen M. Burns, and Robin M. Overstreet
SEDAR74-RD41	Multidecadal meta-analysis of reproductive parameters of female red snapper ( <i>Lutjanus campechanus</i> ) in the northern Gulf of Mexico	Nancy J. Brown-Peterson, Christopher R. Peterson, and Gary R. Fitzhugh
SEDAR74-RD42	A Comparison of Red Snapper Reproductive Potential in the Northwestern Gulf of Mexico: Natural versus Artificial Habitats	Hilary D. Glenn, James H. Cowan Jr. & Joseph E. Powers
SEDAR74-RD43	Temporal and spatial comparisons of the reproductive biology of northern Gulf of Mexico (USA) red snapper ( <i>Lutjanus campechanus</i> ) collected a decade apart	Dannielle H. Kulaw, James H. Cowan Jr., and Melissa W. Jackson
SEDAR74-RD44	Effect of circle hook size on reef fish catch rates, species composition, and selectivity in the northern Gulf of Mexico recreational fishery	William F Patterson III, Clay E Porch, Joseph H Tarnecki, and Andrew J Strelcheck
SEDAR74-RD45	Experimental Assessment of Circle Hook Performance and Selectivity in the Northern Gulf of Mexico Recreational Reef Fish Fishery	Steven B. Garner, William F. Patterson III, Clay E. Porch, and Joseph H Tarnecki
SEDAR74-RD46	Simulating effects of hook-size regulations on recreational harvest efficiency in the northern Gulf of Mexico red snapper fishery	Steven B. Garner, William F. Patterson III, John F. Walter, and Clay E. Porch
SEDAR74-RD47	Effect of reef morphology and depth on fish community and trophic structure in the northcentral Gulf of Mexico	Steven B. Garner, Kevin M. Boswell, Justin P. Lewis, Joseph H. Tarnecki, William F. Patterson III



SEDAR74-RD48	Linear decline in red snapper ( <i>Lutjanus campechanus</i> ) otolith D14C extends the utility of the bomb radiocarbon chronometer for fish age validation in the Northern Gulf of Mexico	Beverly K. Barnett, Laura Thornton, Robert Allman, Jeffrey P. Chanton, and William F. Patterson III
SEDAR74-RD49	Changes in Reef Fish Community Structure Following the Deepwater Horizon Oil Spill	Justin P. Lewis, Joseph H. Tarnecki, Steven B. Garner, David D. Chagaris & William F. Patterson III
SEDAR74-RD50	The Utility of Stable and Radioisotopes in Fish Tissues as Biogeochemical Tracers of Marine Oil Spill Food Web Effects	William F. Patterson III, Jeffery P. Chanton, David J. Hollander, Ethan A. Goddard, Beverly K. Barnett, and Joseph H. Tarnecki
SEDAR74-RD51	A Review of Movement in Gulf of Mexico Red Snapper: Implications for Population Structure	William F. Patterson, III
SEDAR74-RD52	Changes in Red Snapper Diet and Trophic Ecology Following the Deepwater Horizon Oil Spill	Joseph H. Tarnecki and William F. Patterson III
SEDAR74-RD53	Population Structure of Red Snapper in the Northern Gulf of Mexico	John R. Gold and Eric Saillant
SEDAR74-RD54	Mitochondrial DNA variation among red snapper ( <i>Lutjanus campechanus</i> ) from the Gulf of Mexico	Jeff Camper, John R. Gold, and Robert C. Barber
SEDAR74-RD55	A molecular approach to stock identification and recruitment patterns in red snapper ( <i>Lutjanus campechanus</i> )	R.W. Chapman, S.A. Bortone, and C.M. Woodley
SEDAR74-RD56	Stock Structure, connectivity, and effective population size of red snapper ( <i>Lutjanus campechanus</i> ) in the U.S. waters of the Gulf of Mexico	David S. Portnoy
SEDAR74-RD57	Mitochondrial DNA variation among 'red' fishes from the Gulf of Mexico	John R. Gold and Linda R. Richardson

SEDAR74-RD58	Population structure of red snapper ( <i>Lutjanus campechanus</i> ) in U.S. waters of the western Atlantic Ocean and the northeastern Gulf of Mexico	Christopher M. Hollenbeck, David S. Portnoy, Eric Saillant, John R. Gold
SEDAR74-RD59	Population structure and variance effective size of red snapper ( <i>Lutjanus campechanus</i> ) in the northern Gulf of Mexico	Eric Saillant and John R. Gold
SEDAR74-RD60	Population Structure and Variation in Red Snapper ( <i>Lutjanus campechanus</i> ) from the Gulf of Mexico and Atlantic Coast of Florida as Determined from Mitochondrial DNA Control Region Sequence	Amber F. Garber, Michael D. Tringali and Kenneth C. Stuck
SEDAR74-RD61	Genetic homogeneity among geographic samples of snappers and groupers: evidence of continuous gene flow	John R. Gold and Linda R. Richardson
SEDAR74-RD62	Population Structure of Red Snapper from the Gulf of Mexico as Inferred from Analysis of Mitochondrial DNA	J. R. Gold, E Sun, and L. R. Richardson
SEDAR74-RD63	DNA Microsatellite Loci and Genetic Structure of Red Snapper in the Gulf of Mexico	Ed Heist and John R. Gold
SEDAR74-RD64	Genetic impacts of shrimp trawling on red snapper ( <i>Lutjanus campechanus</i> ) in the northern Gulf of Mexico	Eric Saillant, S. Coleen Bradfield, and John R. Gold
SEDAR74-RD65	Genetic variation and spatial autocorrelation among young-of-the-year red snapper ( <i>Lutjanus campechanus</i> ) in the northern Gulf of Mexico	Eric Saillant, S. Coleen Bradfield, and John R. Gold

SEDAR74-RD66	Connections between Campeche Bank and Red Snapper Populations in the Gulf of Mexico via Modeled Larval Transport	Donald R. Johnson, Harriet M. Perry, and Joanne Lyczkowski-Shultz
SEDAR74-RD67	Red snapper, <i>Lutjanus campechanus</i> , larval dispersal in the Gulf of Mexico	Donald R. Johnson and Harriet M. Perry
SEDAR74-RD68	Historical population demography of red snapper ( <i>Lutjanus campechanus</i> ) from the northern Gulf of Mexico based on analysis of sequences of mitochondrial DNA	Christin L. Pruett, Eric Saillant, and John R. Gold
SEDAR74-RD69	Microsatellite Variation Among Red Snapper ( <i>Lutjanus campechanus</i> ) from the Gulf of Mexico	John R. Gold, Elena Pak, and Linda R. Richardson
SEDAR74-RD70	Genomics overrules mitochondrial DNA, siding with morphology on a controversial case of species delimitation	Carmen del R. Pedraza-Marron, Raimundo Silva, Jonathan Deeds, Steven M. Van Belleghem, Alicia Mastretta-Yanes, Omar Dominguez-Domínguez, Rafael A. Rivero-Vega, Loretta Lutackas, Debra Murie, Daryl Parkyn, Lewis H. Bullock, Kristin Foss, Humberto Ortiz-Zuazaga, Juan Narvaez-Barandica, Arturo Acero, Grazielle Gomes, and Ricardo Betancur-R
SEDAR74-RD71	SEDAR52-WP-20: Use of the Connectivity Modeling System to estimate movements of red snapper ( <i>Lutjanus campechanus</i> ) recruits in the northern Gulf of Mexico	M. Karnauskas, J. F. Walter III, and C. B. Paris
SEDAR74-RD72	Fine-scale partitioning of genomic variation among recruits in an exploited fishery: causes and consequences	Jonathan B. Puritz, John R. Gold & David S. Portnoy

SEDAR74-RD73	Historical Population dynamics of red snapper ( <i>Lutjanus campechanus</i> ) in the northern Gulf of Mexico	J. R. Gold and C. P. Burridge
SEDAR74-RD74	Red Snapper Larval Transport in the Northern Gulf of Mexico	Donald R. Johnson, Harriet M. Perry, Joanne Lyczkowski-Shultz & David Hanisko
SEDAR74-RD75	Talking Smack: the archaeology and history of Pensacola's red snapper fishing industry	Nicole Rae Bucchino
SEDAR74-RD76	Distribution, Abundance, and Age Structure of Red Snapper ( <i>Lutjanus campechanus</i> ) Caught on research Longlines in the U.S. Gulf of Mexico	Karen M. Mitchell, Terry Henwood, Gary R. Fitzhugh, and Robert J. Allman
SEDAR74-RD77	SEDAR31-DW15: Spatio-temporal dynamics in red snapper reproduction on the West Florida Shelf, 2008-2011	Susan Lowerre-Barbieri, Laura Crabtree, Theodore S. Switzer, and Robert H. McMichael, Jr.
SEDAR74-RD78	SEDAR52-WP-15: Reproductive data compiled for the Gulf of Mexico Red Snapper, <i>Lutjanus campechanus</i> , SEDAR 52	G.R. Fitzhugh, H.M. Lyon, V.C. Beech, P.M. Colson
SEDAR74-RD79	Trophic ecology of red snapper <i>Lutjanus campechanus</i> on natural and artificial reefs: interactions between annual variability, habitat, and ontogeny	Rachel A. Brewton, Charles H. Downey, Matthew K. Streich, Jennifer J. Wetz, Matthew J. Ajemian, Gregory W. Stunz
SEDAR74-RD80	Comparing reproductive capacity of nearshore and offshore red snapper, <i>Lutjanus campechanus</i> , on artificial reefs in the western Gulf of Mexico	Ricky J. Alexander
SEDAR74-RD81	Reduction of juvenile red snapper bycatch in the U.S. Gulf of Mexico shrimp trawl fishery	Benny J. Gallaway and John G. Cole

SEDAR74-RD82	A Life History Review for Red Snapper in the Gulf of Mexico with an Evaluation of the Importance of Offshore Petroleum Platforms and Other Artificial Reefs	Benny J. Gallaway, Stephen T. Szedlmayer, and William J. Gazey
SEDAR74-RD83	Delineation of Essential Habitat for Juvenile Red Snapper in the Northwestern Gulf of Mexico	Benny J. Gallaway, John G. Cole, Robert Meyer, and Pasquale Roscigno

## 2 STOCK ID PANEL REPORT

### 2.1 EXECUTIVE SUMMARY

Three working groups and their subgroups reviewed studies and provided data to support the delineation of the red snapper dynamics in the Gulf of Mexico (GOM). Given the breadth of information available the various working groups provided support for multiple stock boundaries, including the Mississippi river outflow (between statistical zones 12/13), Cape San Blas, FL (between statistical zones 7/8), the De Soto Canyon (between statistical zones 9/10), and the Big Bend area (statistical zones 7/6, Figure 1). Initially, the working groups were unable to come to a decision about the recommended biological stock boundaries, and instead provided information to support their individual working group recommendations. Due to the lack of agreement amongst the groups, three possible stock ID boundary options were proposed for the third and final workshop. All proposed stock ID options aimed to incorporate most working group recommendations and concerns. Based on the proposed stock ID options and in consideration of the spatial differences in red snapper biology and fishery dynamics presented by the working groups, an Assessment Unit Stock ID recommendation was made at the final workshop, Option C. There was general consensus among participants about the recommendation for the final Stock ID assessment units, though some apprehension was expressed by some individuals.

Below is a summary of the biological stock recommendations supported by the different working groups and their subgroups, along with the summaries of the stock ID options and the final assessment unit stock consensus recommendation. See pages 23-72 for the final working group reports from the Stock ID Workshop.

## Biological Stock Recommendations

### *Genetics*

A review of the research to date on red snapper genetics failed to produce a definitive recommendation for stock structure in the Gulf of Mexico (GOM). Despite the inconclusive results, several themes emerged during the stock ID deliberations. The information reviewed consistently indicated that the Gulf population is not a single, well-mixed unit and likely consists of metapopulations that experience periodic low level gene flow through adult migration and larval drift. Demographic analyses comparing the genetics of young-of-the-year fish and adults showed that recruitment predominantly occurs from distinct pools, highlighting the importance of maintaining healthy spawning populations throughout the Gulf. Analyses conducted during the most comprehensive study to date (Portnoy 2017) were inconclusive regarding the status of the area between Cape San Blas, FL and the Mississippi River; however, some models showed more affinity of samples from this region with the eastern GOM. Further analysis of this dataset also indicated a genetic discontinuity along the West Florida Shelf but could not define an exact boundary. The genetics workgroup did not make any specific stock structure recommendations.

### *Life History*

The life history working group formed two subgroups, one focusing on age, growth & reproduction (AGR) and the other on movement. The AGR subgroup identified a number of trends in the data that lent support to the hypothesis that GOM red snapper are organized as metapopulations rather than biologically distinct or reproductively isolated sub-populations. Spatial differences in maximum age and age distribution were observed with older aged fish found in the western and central (MS, AL, and FL panhandle) GOM. Studies analyzing spatial differences in growth rates of red snapper showed a general decline from east to west. The review of available research on red snapper reproduction produced several conclusions. Red snapper have a similar spawning season across the northern GOM. Spawning occurs throughout the species range and occurs within an individual's home range rather than specific spawning habitats. In the western Gulf, red snapper had greater size and age at 50% maturity, greater spawning interval, and lower fecundity compared to the eastern GOM. However, data were insufficient to determine if these differences were the result of distinct biology or the difference

in size and age composition between the eastern and western Gulf. Based on their review of the data the AGR subgroup recommended a three-unit model with boundaries at the Mississippi River (between statistical zones 12/13) and at Cape San Blas, FL (between statistical zones 7/8).

The movement subgroup reviewed studies of larval dispersal and connectivity, ontogenetic movement, and adult movement of red snapper. Studies of larval dispersal and connectivity showed that the vast majority of successful recruits settle in the region in which they are spawned. Some cross-region transport of larvae does occur; however, the Mississippi River outflow and to a lesser extent the Apalachicola Peninsula act as significant impediments to larval transport. Models of ontogenetic movement predicted that in the eastern GOM juvenile red snapper around Louisiana, Mississippi, and Alabama tend to move eastward through the Florida Panhandle and toward the west Florida shelf as they age. In the western GOM, red snapper were predicted to exhibit offshore movement rather than along shore movements with increasing age. Review of acoustic and conventional tagging studies for adult red snapper identified several pertinent conclusions. First, adult red snapper exhibit high site fidelity with periodic short range (1-10K) movements. Second, longer range movements (>100K) were observed infrequently and were very rarely recorded crossing known impediments like the Mississippi River and Apalachicola Peninsula. The movement sub-group recommended maintaining the status-quo model with the boundary located at the Mississippi River delta (between statistical zones 12/13), with some evidence for an additional boundary at or near Cape San Blas, FL (border of statistical zones 7-8).

Upon review of the subgroup reports, the overall recommendation from the life history working group was for a three-stock model with the primary boundary located at the Mississippi River (between statistical zones 12/13), and a secondary boundary at or near Cape San Blas, FL (between statistical zones 7/8). This recommendation reflects a majority consensus of those who participated in the life history working group discussions; however, additional recommendations were proposed. For example, a two-stock model with a division between statistical zones 10/11 was proposed yet not supported by the majority of the working group.

### *Landings and CPUE*

The landings and CPUE working group reviewed data from fishery-dependent and fishery-independent sources, in order to understand differences in regional landings, CPUE, and in some cases length composition. The data reviewed included commercial data (longline and vertical line) from 1984-2019, general recreational data (private and charter modes) from 1986-2019, Southeast Regional Headboat Survey (SRHS) data within the same time frame, and reef fish video surveys from Panama City, Mississippi, and FWRI. Landings from the commercial sector data were made available but are not included in the working group report.

A large portion of the general recreational GOM landings were from the northeast, with the Florida panhandle currently contributing 36.7%, but has been increasing over time. Alabama contributes 32%, and Louisiana currently contributes 19.9% but has decreased over time. All other areas (Texas, Mississippi, and western Florida also referred to as Southwest Florida-SWFL) consistently contribute considerably less to the overall GOM landings. From the SRHS data, which is 9.04% of the overall recreational data, similar regional patterns were observed. These patterns include the importance of the Northwest Florida (NWFL)/AL region and its increase in landings over time as well as the lack of landings from SWFL. In contrast to the general recreational data the SRHS data indicated a relatively high contribution from Texas to the overall landings. The patterns in SRHS landings were also seen in its CPUE where Texas has the highest CPUE, while CPUE in the eastern GOM are slightly lower.

The various reef fish surveys had similar patterns in CPUE to one another, which included clear differences in trends on either side of Cape San Blas, FL (statistical zones 7/8) and a second boundary potentially around Tampa Bay (statistical zones 5/6). Reef fish video surveys also observed generally larger fish in the big bend and south Florida areas compared to the western GOM.

Given the above findings, the recommendation from the landings and CPUE working group were either a two-stock model with a boundary at statistical zones (9/10), or a three-stock model with the primary boundary located at the Mississippi River (between statistical zones 12/13) and a secondary boundary at or near Cape San Blas, FL (statistical zones 7/8). The proposed boundaries allow for the separation and modeling of fish biology and fisheries dynamics evident in the presented data. The suggested boundaries at 9/10 and/or 7/8 are likely to create issues for the assessment for two reasons: 1) small sample sizes for all size composition data, and 2) only



able to reliably separate Alabama from NWFL in the SRHS data since 2013. Moving the secondary boundary at Cape San Blas, FL (7/8) east to the Big Bend region (statistical zones 7/6) was a suggested compromise as it would not require the separation of AL from NWFL in the SRHS data but would still have sample size issues across all data sources.

### 2.1.1 Stock Option Summaries

The large amount of information, and in some cases inconclusive or conflicting recommendations from the individual working groups, prevented the stock ID panel from reaching a consensus decision during the originally scheduled workshops. To facilitate consensus building during a follow up workshop, the analytical team compiled three options papers that summarized the available data and the pros and cons of each plausible stock delineation. The option papers were disseminated using google docs to facilitate collaboration and made available to the panel well ahead of the final meeting with all members encouraged to contribute. Summaries of the option papers are below with the final versions included as appendices to this document.

#### Option A:

A three-unit stock that maintains the current boundary at the Mississippi river outflow (statistical zone 12/13) and adds an additional boundary at the AL/FL border (statistical zone 9/10). Option A was proposed as a proxy for the preferred split at Cape San Blas, FL. This option locates the boundary at the nearest point to the west of Cape San Blas, FL that the recreational data resolution would allow; however, historical (pre-2013) separation of the SRHS data into the proposed regions in option A remained an issue (See Appendix A for further details).

#### Option B:

A two-unit stock that shifts the current boundary at the Mississippi River outflow eastward to the AL/FL border (in proximity to the De Soto Canyon, statistical zones 9/10). Option B was proposed by members of the landings and CPUE and life history groups. Proponents of option B think that it most appropriately separates differences in relative abundance, as inferred from CPUE, and more closely matches the ecological boundaries influencing northern Gulf red

snapper. Historical (pre-2013) separation of the SRHS data into the proposed regions in option B could not be reliably accomplished as in option A (See Appendix B for further details).

#### Option C:

A three-unit stock that maintains the current boundary at the Mississippi river outflow (statistical zone 12/13) and adds an additional split east of Cape San Blas, FL and slightly north of Tampa (statistical zones 7/6). Option C was proposed as a proxy for the preferred split at Cape San Blas, FL. This option locates the boundary at the nearest point to the east of Cape San Blas, FL that the recreational data resolution would allow (See Appendix C for further details).

#### 2.1.2 Assessment Unit Stock Recommendation

Following review of the working group reports, the panel identified two stock structures that could be supported by the data. One option, supported by the majority of the panel, proposed a three-unit stock structure with boundaries at the Mississippi River and Cape San Blas, FL. Unfortunately, the resolution at which the recreational fisheries were surveyed made it logistically impossible to subset the data at Cape San Blas, FL. Options A and C were presented as the closest alternatives to the Cape San Blas, FL boundary that could accommodate the data. Of these, Option C was eventually selected as the most appropriate alternate to the preferred boundary at Cape San Blas, FL, while also providing the data providers and analysts the ability to revert to the status quo boundary if models do not converge. Option C also did not require an ad hoc adjustment to Alabama SRHS landings prior to 2013. Option B, which created a two-stock model with a boundary between Florida and Alabama, was supported by the remainder of the panel.

The boundaries of Option C aim to take into account the biological recommendations of the various working groups. Although the Mississippi river boundary may not be fully supported by genetic information it does have some implications for differences in regional stock productivity as it strongly influences larval retention. Biological differences such as changes in length composition and maximum age exist on either side of the Mississippi River boundary supporting the argument for its retention. The biogeographic influence of the De Soto Canyon or Cape San Blas, FL may influence stock differences but the current data are inadequate at describing the mechanism for its influence on the populations dynamics and therefore difficult to model in the

assessment. In addition, Option C allows for maintaining the integrity of the SRHS data for Alabama which cannot be reliably split from the Florida panhandle. Doing so would require ad hoc analyses that would likely violate statistical assumptions.

While Option C was ultimately selected as the stock structure for SEDAR 74, it was not without objection. Several members of the panel strongly supported Option B as the more appropriate stock structure and expressed concern with the stock ID process and the need to select a single stock structure for exploration during a research track assessment. From a strictly academic perspective, advancing multiple stock structures through the assessment process and comparing them via model diagnostics and simulation studies would be ideal. Unfortunately, the personnel time needed to provision red snapper data for multiple spatial structures and complete the subsequent assessments was not budgeted for SEDAR 74. Special consideration from the SEDAR steering committee would be needed well in advance of the assessment to accommodate such a request as it is essentially asking for the completion of two independent stock assessments.

## Figures



**Figure 1.** National Marine Fisheries Service (NMFS) fishing area, divided into 23 statistical fishing zones. Green lines indicate Option C, which was recommended by the Stock ID Panel: assessment stock boundaries between statistical zones 12/13- Mississippi River outflow, and zones 7/6 - Big Bend.

## 2.2 LIFE HISTORY WORKING GROUP

Names and affiliations of the SEDAR 74 Stock ID Life History Working Group. Participation in the first and second working group calls, and subsequent email discussions, are indicated.

<b>Participants</b>	<b>Affiliation</b>	<b>Call 1: 4/19/21</b>	<b>Call 2: 5/28/21</b>	<b>Email Discussions</b>
Jason Adriance	LDWF	•		
Robert Allman	NOAA SEFSC Panama City	•	•	•
Beverly Barnett	NOAA SEFSC Panama City	•	•	•
Kristan Blackhart	NOAA OST	•		
Steve Bortone	Osprey Aquatic Sciences	•		
Nancy Brown-Peterson	USM GCRL	•	•	•
Jessica Carroll	FWC	•		
Matt Catalano	Auburn University			
Judd Curtis	SAFMC	•	•	•
Michael Dance	LSU	•	•	•
LaTree Denson	NOAA SEFSC Miami	•		
Marcus Drymon	MSU and MASGC (Group Lead)	•	•	•
Kerry Flaherty-Walia	FWC	•		
Benny Galloway	LGL Associates	•		•
Steve Garner	NOAA SEFSC Panama City	•	•	•
Jay Grove	NOAA SEFSC Miami	•		
Amanda Jefferson	MSU and MASGC	•	•	•
Mandy Karnauskas	NOAA SEFSC Miami	•		•
Matt Laretta	NOAA SEFSC Miami			
Susan Lowerre-Barbieri	UF and FWC	•	•	•
Peter Mudrak	Auburn University	•		
Julie Neer	SAFMC	•		
Will Patterson	UF			
Sean Powers	USA and DISL			
Katie Siegfried	NOAA SEFSC Miami			
Matt Smith	NOAA SEFSC Miami	•		
Matt Streich	TAMU-CC	•		
Ted Switzer	FWC			
Steve Szedlmayer	Auburn University			
Ana Vaz	UM	•		

### 2.2.1 Life History Working Group Executive Summary

A life history working group was assembled to discuss potential changes to the stock ID boundary for red snapper, currently located between NOAA Fisheries statistical grids 12 and 13 (i.e., at the outflow of the Mississippi River) (Table 1). The group was further split into two sub-groups: one for age, growth, and reproduction, and one for movement. These two sub-groups met several times virtually with additional communication via phone and email.

The recommendation from the life history working group is for a three-stock model with the primary boundary located at the Mississippi River (between zones 12/13), and a secondary boundary at or near Cape San Blas, FL (zones 7/8). This recommendation reflects a majority consensus of those who participated in the life history working group discussions; however, additional recommendations were proposed. For example, a two-stock model with a division between zones 10/11 was proposed (Gallaway and Cole 1999 a,b and Gallaway et al. 2009), yet not supported by the majority of the working group. Summaries of the datasets and literature examined by the age/growth/reproduction sub-group and the movement subgroup are provided below.

### 2.2.2 Age, Growth and Reproduction

The age, growth and reproduction life history stock ID sub-group reviewed studies examining spatial differences in these life history parameters for Gulf of Mexico (GOM) red snapper. The group also analyzed fishery-independent length and age data submitted for the last red snapper assessment (SEDAR 52).

#### Age

Spatial differences in age distributions were noted from fishery-independent (Mitchell et al. 2002) and fishery-dependent (Allman et al. 2002; Allman and Fitzhugh 2005) datasets with older ages reported from the western GOM (west of MS river) compared to the eastern GOM. This trend was also noted for maximum calendar age estimates of fishery independent ages collected from 1986-2016; moreover, ages from the central GOM (off AL and the western FL panhandle) were also comprised of greater maximum ages compared to the eastern GOM (Fig 1). A comparison of these data from 3 time periods 1986-2004, 2005-2010 and 2011-2016 all indicated a similar spatial pattern in maximum ages.

### Growth

Two GOM studies made direct spatial comparisons of red snapper growth parameters. Fischer et al. (2004) sampled recreational landings from AL, LA and south TX. Red snapper off TX were found to have significantly lower  $L_{\infty}$  and greater  $k$  compared to LA and AL, but these differences may have been due to the absence of larger fish from TX. Linear regressions of mean fork length at age for ages 2-10 found no significant difference among states. A later study by Saari et al. (2014) compared red snapper collected from the recreational fishery in 6 regions of the GOM (south TX, north TX, LA, AL, northwest FL and central FL). They found that red snapper collected off FL and south TX were on average smaller and grew at a faster rate compared to other regions. Saari et al. (2014) also reported that strong 2004, 2005 and 2006 year classes were detected across all 6 regions sampled. Similarly, Allman and Fitzhugh (2007) recorded strong 1989 and 1995 year-classes in both the eastern and western GOM. Saari et al. (2014) concluded that a combination of demographic differences and consistency in dominant year classes gulf wide, supported recent conclusions that red snapper form meta-populations of semi-isolated assemblages that are demographically distinct, but also influenced by mixing between assemblages.

Spatial differences were also observed in the size-at-age of red snapper collected on fishery-independent surveys. Observed mean size-at-age compared across 4 regions (TX, LA, AL/FL panhandle and west FL shelf) suggested fastest growth off the west FL shelf followed by AL/FL panhandle and the slowest growth in the western GOM (Fig. 2). Breaking down further into 6 regions (southwest FL, west FL shelf, AL/FL panhandle, LA, north TX and south TX) provided additional support for an overall decline in growth rate from east to west across the northern GOM (Fig. 3).

### Reproduction

Several studies have examined spatial differences in reproductive parameters for GOM red snapper. Brown-Peterson et al. (2009) sampled the headboat and commercial fishery on the Florida east coast and Dry Tortugas (GOM) and found that relative fecundity estimates were lower for Dry Tortugas compared to east coast of Florida. Spawning frequency was also greater for east coast fish (2.2 days) compared to Dry Tortugas (4.3 days). Another study off FL by

Lowerre-Barbieri et al. (2012) used fishery-independent sampling and found that spawning red snapper off Tampa were smaller and younger than those off the FL panhandle. Kulaw et al. (2017) examined temporal (10 years apart) and spatial differences in sexual maturity and egg production. They found that mean GSI was generally greater in eastern GOM (AL) compared to western GOM (LA) and fish matured at smaller sizes and ages in the eastern GOM compared to the western GOM on artificial habitat for both time periods. Batch fecundity estimates were greater in the east than in the west during the early period with no difference for sampling period 2 and no difference in spawning frequency east or west by age class was noted. Porch et al. (2015) is the only study to-date which sampled Gulf-wide with standardized methodology. They evaluated the relationship between spawning fraction and female length and age, time of year, depth, gear type (vertical line or longline), or region (east or west of the MS River). They found that the effects of region and gear type were not significant once time of year and size or age were accounted for and suggested that regional difference may not be due to any intrinsic difference in the biology of the fish, but due to there being more large, old red snapper in the western GOM. Brown-Peterson et al. (2019) used meta-analysis models to analyze data collected from 1991-2017 in the eastern and western GOM. They found an increase in the spawning interval in northwest GOM over time and no notable change in northeast GOM. Relative batch fecundity decreased to a greater degree in the northwest GOM compared to the northeast GOM suggesting reproductive compensation in the northwest GOM. From these studies and other ongoing research, the life history group concluded that: 1. duration of the spawning season is similar across the northern GOM, 2. red snapper from the western GOM had a greater size and age at 50% maturity, greater spawning interval and lower fecundity compared to the eastern GOM. However, we do not have the needed data to determine if these observed differences are due to differences in the biology of red snapper, or to differences in size and age distributions between the eastern and western GOM, and 3. red snapper spawning is exhibited throughout their range (Fig. 4), with adults exhibiting high annual site fidelity and spawning at these sites rather than moving to specific spawning habitat. This reproductive strategy suggests reproductive isolation at much smaller spatial scales than any of the suggested stock boundaries. Overall, the reproductive sub-component of the Life History sub-group noted that existing data is not sufficient to definitively determine if there are any Gulf-wide differences in Red Snapper

reproduction due to differing data collection/analyses methodologies across studies, and thus the entire Gulf of Mexico could be considered a single stock.

***Age, Growth and Reproduction sub-group recommendation:*** The life history age, growth and reproduction sub-group recommends a 3 region model, keeping the original division at the MS river (between statistical grids 12-13) and adding a division at Cape San Blas (between statistical grids 7-8). These divisions are based on known faunal breaks, differences in age composition, growth rates and size-at-maturity of red snapper.

### 2.2.3 Movement

The movement sub-group of the life history working group reviewed and summarized the available literature pertaining to the movement and population connectivity of red snapper throughout the Gulf of Mexico (GOM) at various ontogenetic life stages. These studies included modeling of larval transport, mark-recapture conventional tagging studies, acoustic telemetry, and ontogenetic movement modeling.

#### Larval Connectivity

Studies modeling larval transport and connectivity showed that a barrier near the Mississippi River minimizes nearly all of the cross-subregion larval transport. A primary boundary at ~89W degrees (Mississippi River) restricted the larval transfer rate to <2% with 98% of successfully settling larvae being retained in regions in which they were spawned (Karnauskas & Paris, SEDAR74-SID-02; Figures 5-7). A secondary division at ~85W degrees (Cape San Blas) had between 2-3% larval transfer rate. However, the authors note that “setting a subpopulation boundary near the Mississippi River minimizes nearly all of the cross-subregion larval transport, and designation of a second barrier has little additional benefit in terms of separating out functionally different regions with respect to spawning and recruitment dynamics” (Karnauskas & Paris, SEDAR74-SID-02). There was a net eastward movement that occurred in June, July, and August under the influence of weaker shoreward wind stress. Topographic impediments to longshore larval transport in the northern GOM (the Mississippi River delta, DeSoto Canyon, and the Apalachicola peninsula) restricted the quantity of larvae crossing but did not eliminate it (Johnson et al. 2009). Lastly, larval abundance was found to be twice as great over the Louisiana–Texas shelf as over the Mississippi–Alabama shelf and four times as great over the



Mississippi–Alabama shelf as over the West Florida shelf (Hanisko et al. 2007). These results suggest that only a small fraction of the Louisiana–Texas larvae have a chance of being transported eastward across the Mississippi River delta and that the limited transport of larvae across these impediments suggests that separate management may be warranted for the eastern and western GOM.

### Acoustic Telemetry

Several studies using acoustic telemetry tagging have determined that red snapper exhibit high site fidelity, localized movement, and high residency (see Table 1). The mean days detected in each of these studies ranged from 64-324 days with the maximum days detected ranging from 92-1096 days. Acoustic telemetry array designs are often restricted in spatial extent, which limits the utility of this technique for estimating greater movements and dispersal on both spatial and temporal scales. Friess et al. (2021) conducted a meta-analysis of many acoustic arrays along the Florida Gulf coast with many different species. Red snapper were considered to be a high-detection resident with no detections on neighboring arrays and very few gaps between detections on the ‘home’ array. In summary, although some movement of red snapper is detectable through acoustic telemetry occurs, this is primarily at local scales and this movement does not cross purported stock boundaries.

### Mark-Recapture Conventional Tagging

Studies that examined movement using conventional tagging based on mark-recapture methods found mean days at liberty for red snapper to range from 112-404 days, with the maximum from 253-2049 days (Table 2). The mean and maximum distance these fish traveled ranged from 0.3-30.9 km and 5-558 km, respectively. In many studies, the majority (>74%) of fish were recaptured at or within 5 km of the release site. Recapture data from recent tagging studies showed only two fish were recaptured in a different region (Figure 8), and the absolute distance these fish traveled was between 5-23 km. The max distance estimates show that some of these fish do disperse broadly and show large scale movements of 100s of km. Most commonly, however, these movements were found to be within state boundaries. Movement across the Mississippi River boundary was found to be extremely rare, but there was some evidence of movement from Alabama to the Florida panhandle, and further east to the West Florida Shelf (1-

5% from conventional tagging studies) (Patterson et al. 2001, Patterson and Cowan 2003, Addis et al. 2016).

### Ontogenetic Movement (Modeling)

The predicted distribution of juvenile, sub-adult, and adult red snapper abundance over unconsolidated substrates in the Gulf indicated a net eastward shift with age in the eastern Gulf (Dance and Rooker 2019). The center of juvenile abundance in the eastern Gulf was concentrated east of the MS River off of LA/MS/AL (Galloway et al. 1999, Dance and Rooker 2019) and expanded eastward with age to the WFL shelf. Results support connectivity between AL/FL panhandle and the WFL shelf, which was also documented in conventional tagging data. In contrast, a net offshore movement was predicted in the western Gulf. While it should be noted that predictions from this study were focused on fish over unconsolidated substrates rather than reef structures (Dance and Rooker 2019), recent findings suggest a significant proportion of the Gulf red snapper population occurs over unconsolidated bottom (Stunz et al. 2021).

The main conclusions drawn from the synopses of these movement studies are:

1. The primary barrier for larval transfer occurs near the Mississippi River (between stat zones 12/13). While there is evidence of a weaker secondary barrier near Cape San Blas, addition of a second barrier provides little additional benefit with respect to spawning and recruitment dynamics.
2. Acoustic telemetry shows that red snapper exhibit high site fidelity and residency times, though some movement does occur on local scales (1-10 km).
3. Mark and recapture conventional tagging reveals the occurrence of large scale movement (> 100 km) across potential boundaries; however, movements across the Mississippi River boundary are extremely rare, while movement from the AL/FL panhandle to the West Florida Shelf are relatively more common but still low (~1-5%).
4. Information on ontogenetic movement supports an east/west stock split, and there appears to be some exchange between AL/FL panhandle and WFL shelf.

***Movement sub-group recommendation:*** The movement sub-group concludes that the data examined support the current 2-stock model with the boundary located at the Mississippi River

delta (between stat zones 12/13), with some evidence for an additional boundary at or near Cape San Blas (border of statistical grids 7-8).

#### 2.2.4 Additional Considerations

The SEFSC has initiated a participatory conceptual modeling process with experienced anglers in the Gulf of Mexico, to gather insights regarding the red snapper fishery. The process is designed to capture local knowledge on the important physical, biological, social, economic, and regulatory drivers of the red snapper population and its associated fisheries. Preliminary results from this initiative (based on conversations with anglers in the Alabama and Florida panhandle region) suggest that tropical storm activity is perceived as a major driver of adult red snapper movements, by influencing both the migration of red snapper off their normal habitats as well as the distribution of the habitats on which they depend (i.e., by physically moving artificial structures or burying natural reefs). Anglers have noted that movement of adult red snapper following storm activity is highly variable and not unidirectional, and is event-specific depending on the precise storm path and site of intersection with the coast. Further details from this work will be summarized in a Data Workshop working paper and may provide additional insights to the stock identification process.

#### 2.2.5 Tables

**Table 1.** Summary table of results from acoustic telemetry studies

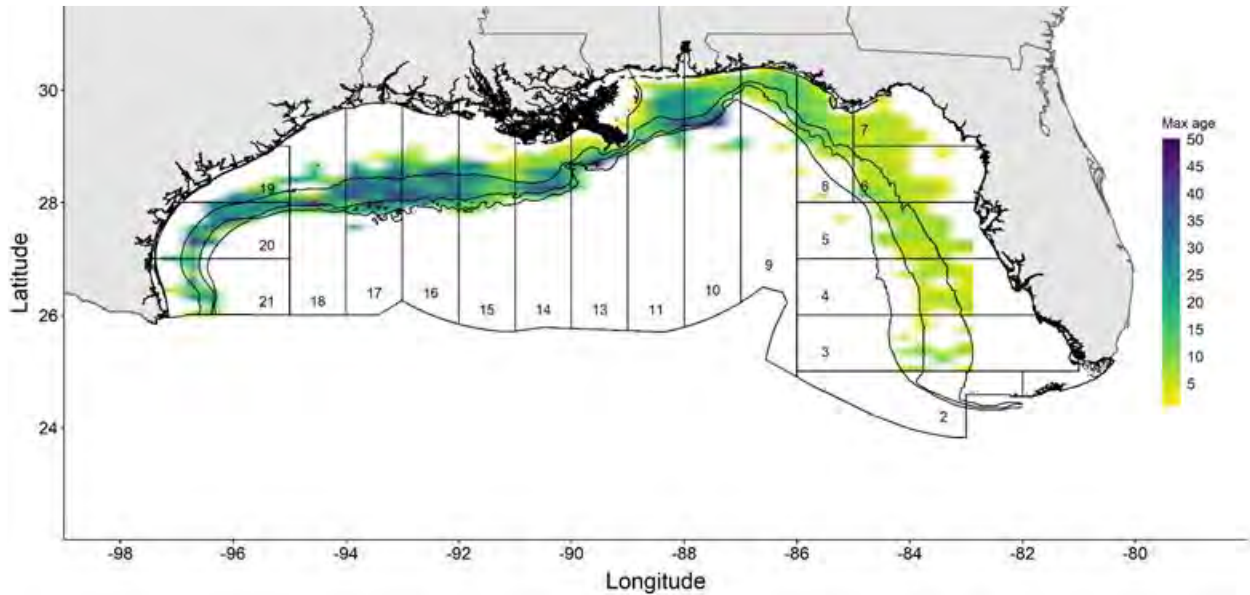
Study	Location	Habitat	Number Tagged	Mean / Max Days Detected	Residency Times
Szedlmayer 1997	Alabama	Artificial	23	150 / 597	-
Szedlmayer & Schroepfer 2005	Alabama	Artificial	54	212 / 595	-
Schroepfer & Szedlmayer 2006	Alabama	Artificial	77	179 / 597	-
Westmeyer et al 2007	Louisiana	Artificial	125	64 / 202	-
Piraino & Szedlmayer 2014	Alabama	Artificial	46	324 / 694	88% after 10mo.
Williams-Grove & Szedlmayer 2016	Alabama	Artificial	56	- / 1096	23 mo, 82% yr <sup>-1</sup>
Froehlich et al 2019	Texas	Artificial	15	72 / 92	
Everett et al 2020	LA / AL	Artificial	59	-	7 mo, 70% at 1yr
Friess et al 2021	Florida	Natural	91	-	150 d

**Table 2.** Summary table of results from mark-recapture conventional tagging studies (modified from Patterson et al. 2007) and mean recapture rates by state.

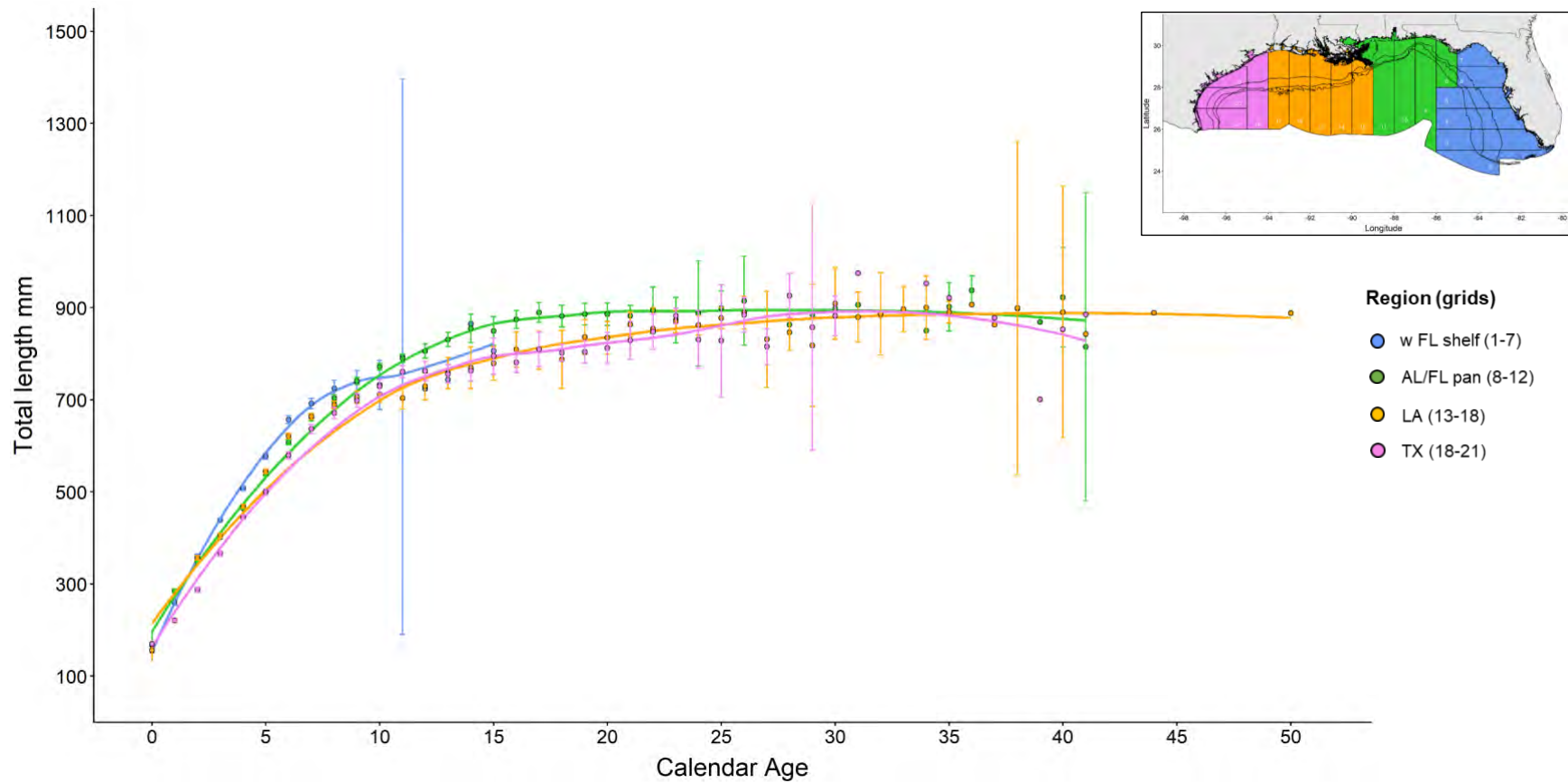
Study	Location	Habitat	#	Recaps	Mean Days	Max Days	Mean Dist	Max Dist	Site fidelity
Beaumariage (1969)	West Florida	Natural	1126	384	113	2049		279	90% w/in 5 km
Fable (1980)	Texas	Both	299	17	112	253	0.3	5	94% at release site
Szedlmayer and Shipp (1994)	Alabama	Artificial	1155	146	137	430	4.6	3.2	74% w/in 2 km
Patterson and Cowan (2003)	Alabama	Artificial	2932	599	404	1501	30.9	558	25-27% per year
Strelcheck et al. (2007)	Alabama	Artificial	4317	629	401	1587	2.1	202	~50% per year
Diamond et al. (2007)	Texas	Both	5614	130	166	564	9.8	58.3	~52% at release site
Addis et al. (2013)	Florida	Artificial	2114	232	313		29.5	320	19% recaptured at release site

State	Tags	Recaps	Recap Rate
Texas	5913	147	2.50%
Alabama	8404	1374	16%
Florida	3240	616	19%

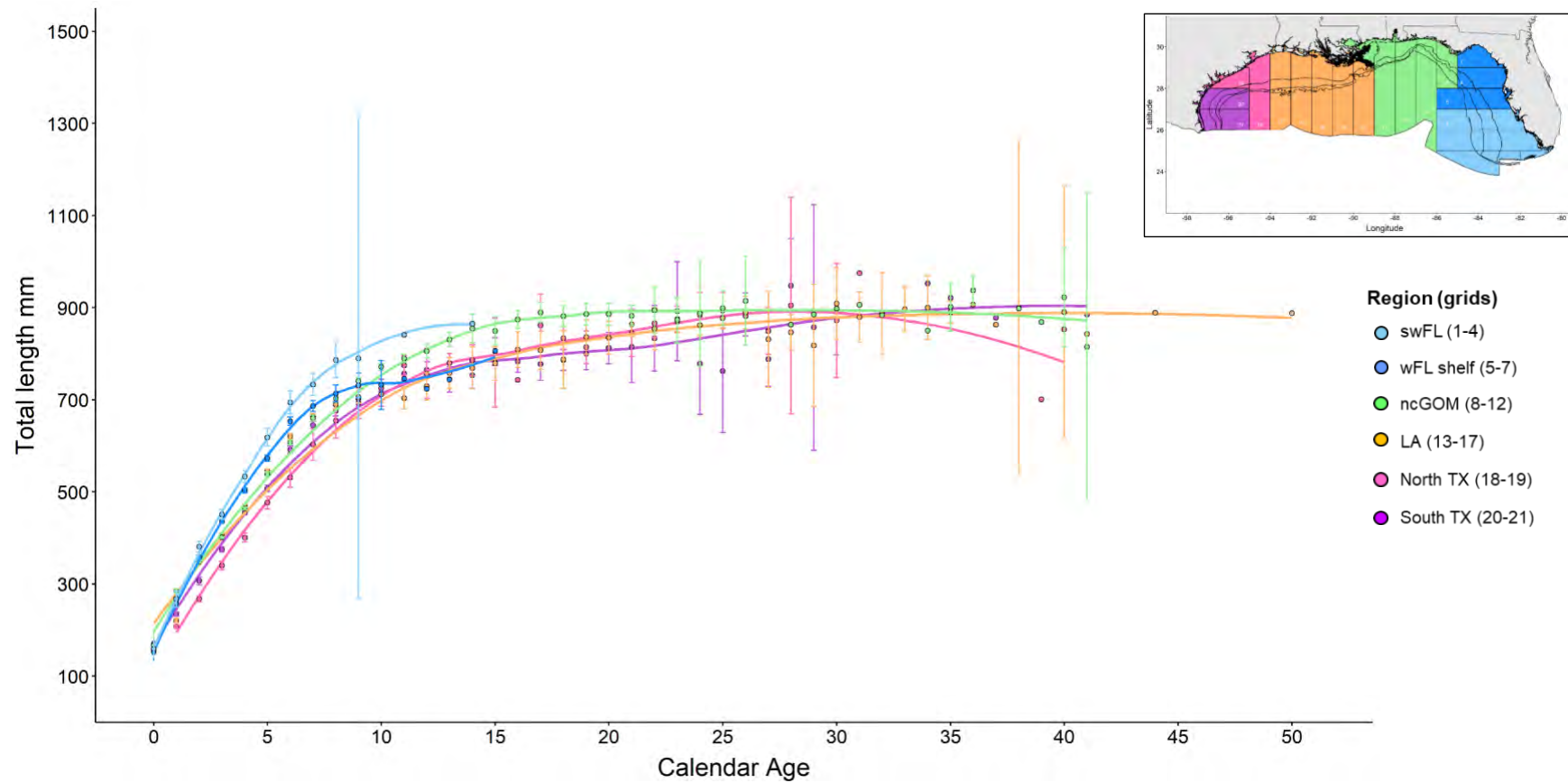
## 2.2.6 Figures



**Figure 1.** Maximum (calendar) age estimates ( $n = 20,348$ ) for GOM red snapper collected from fishery independent surveys (handline, bottom longline, vertical longline, trap, or trawl) conducted in the nGOM from 1986-2016. Grids 1-12 correspond to the eastern GOM; grids 13-21 correspond to the western GOM. The 50, 100, and 200 m isobaths are shown.



**Figure 2.** Mean size-at-age estimates (95% CI; N = 25,132) for GOM red snapper collected from fishery independent surveys from 1986-2016 based on hypothetical stock ID demarcation lines specified at Cape San Blas (85° longitude), MS river outflow (89° longitude), LA/TX border (94° longitude) resulting in four regions: 1) wFL shelf (n = 2,558), AL/FL pan (n = 11,375), LA (n = 6,852), and TX (n = 4,347).



**Figure 3.** Mean size-at-age estimates (95% CI; N = 25,132) for GOM red snapper collected from fishery independent surveys from 1986-2016 based on six hypothetical stock ID regions: 1) south Texas (n = 3,035), 2) north Texas (n = 1,312), 3) Louisiana (n = 6,852), 4) northcentral GOM (n = 11,375), 5) west Florida shelf (n = 2,213), and 6) southwest Florida (n = 345).

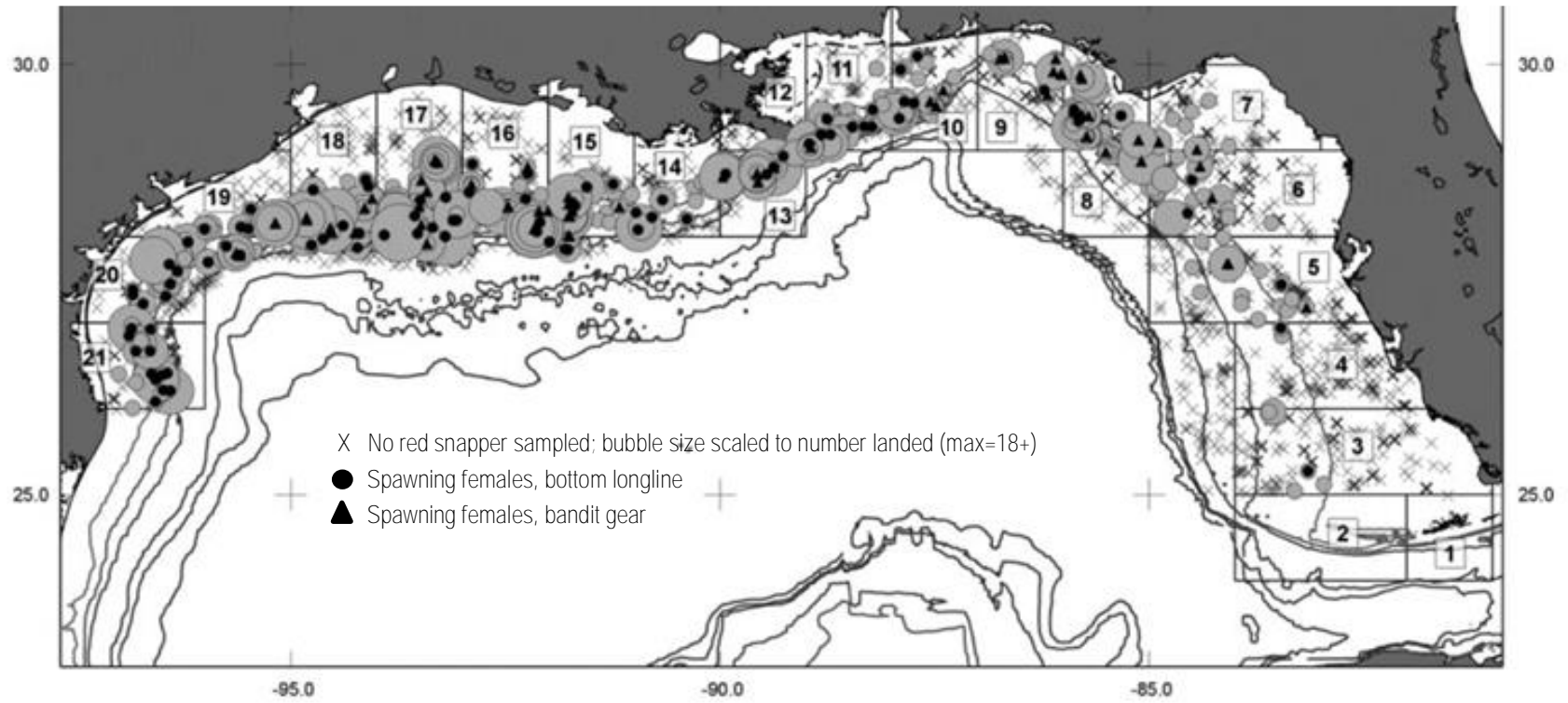


Figure 4. Red snapper spawning sites from Porch et al. (2015)



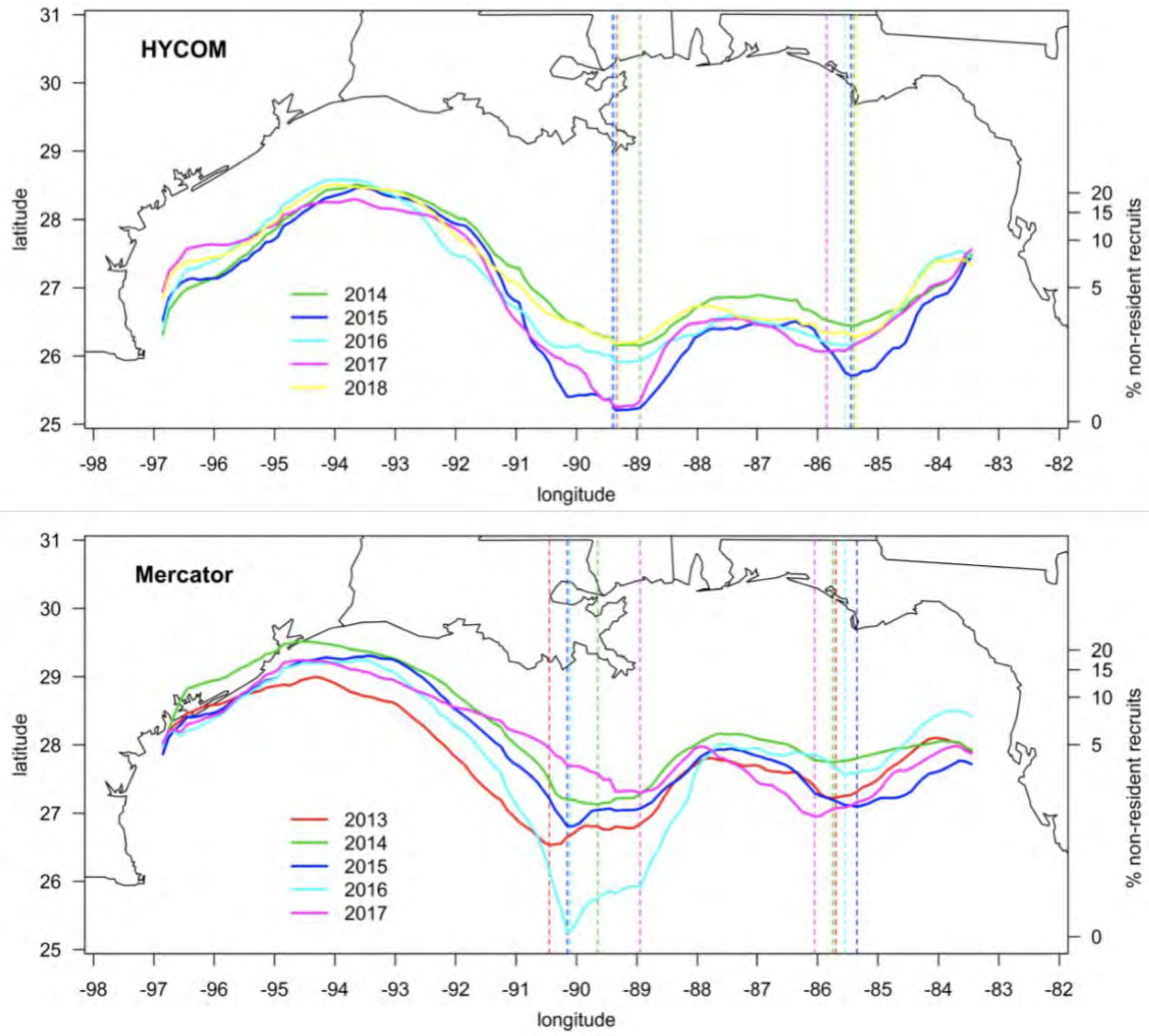


Figure 5: Karnauskas & Paris, SEDAR74-SID-02

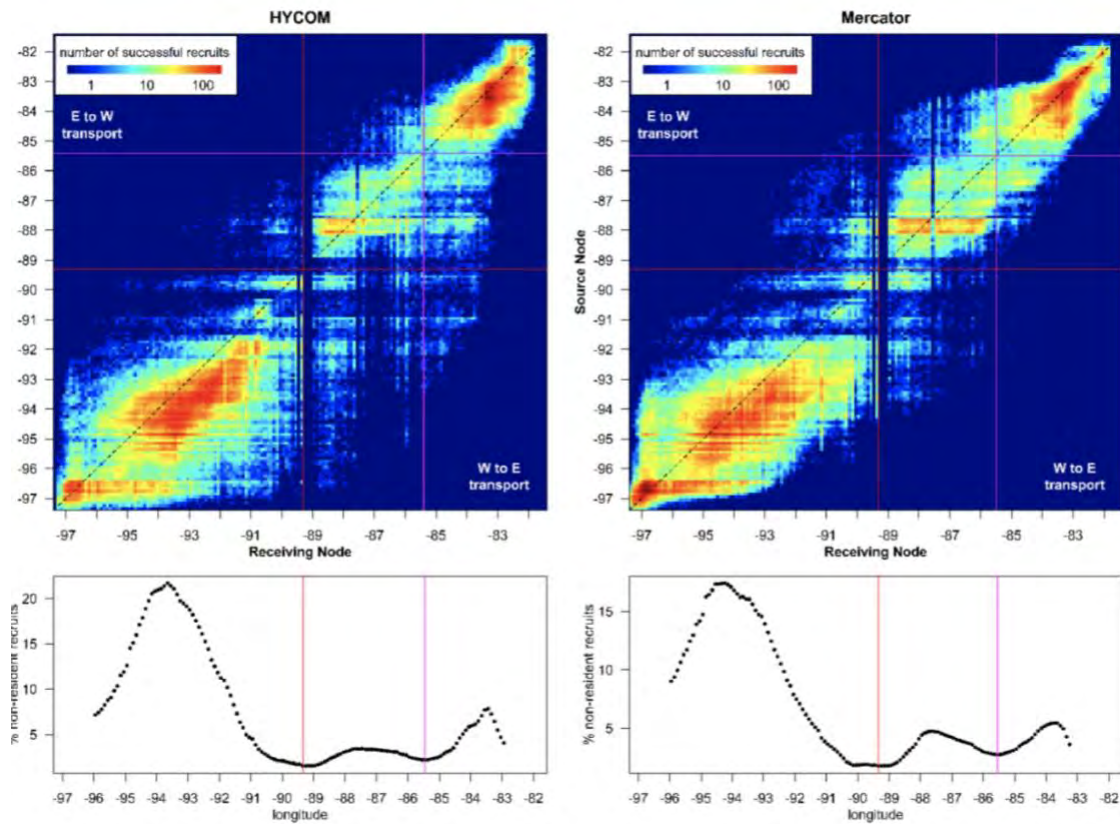


Figure 6: Karnauskas & Paris, SEDAR74-SID-02

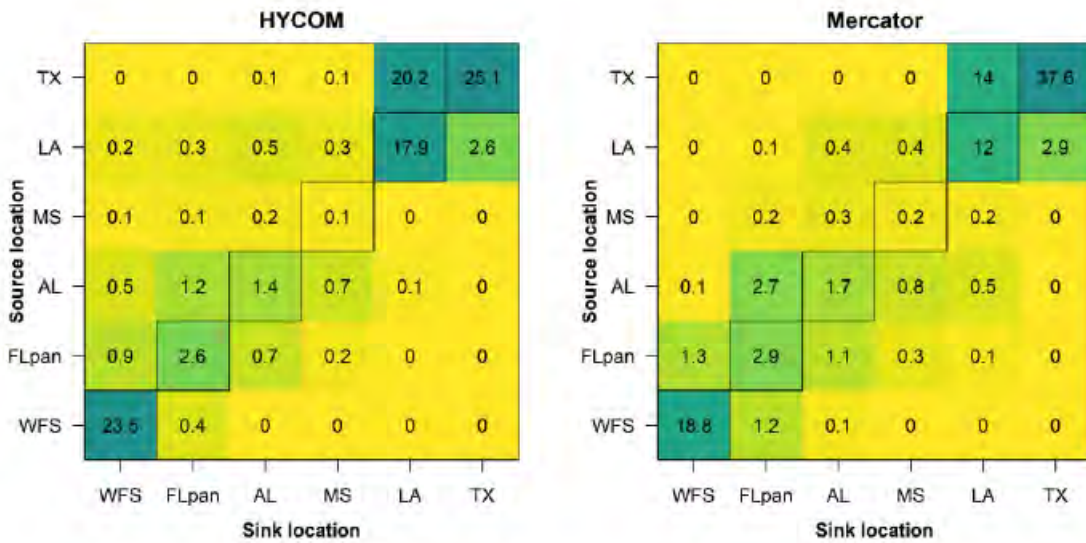
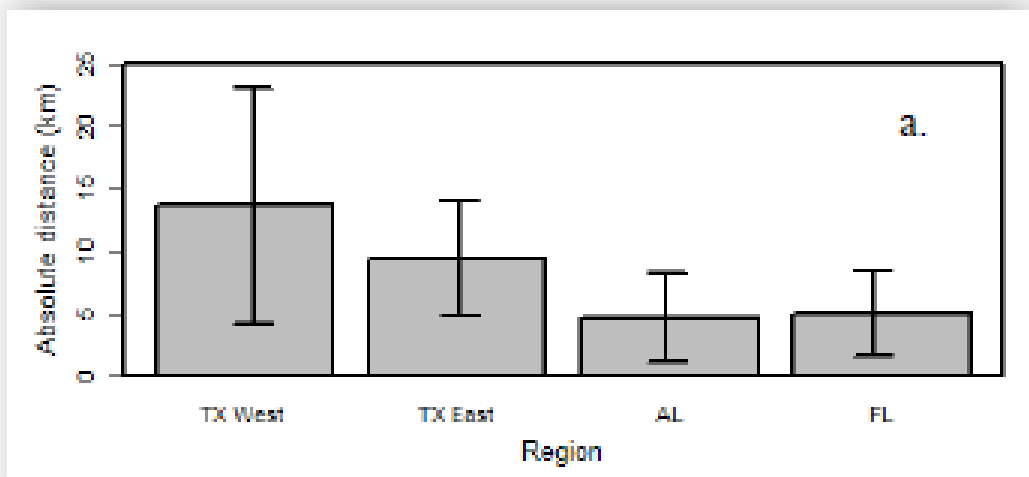
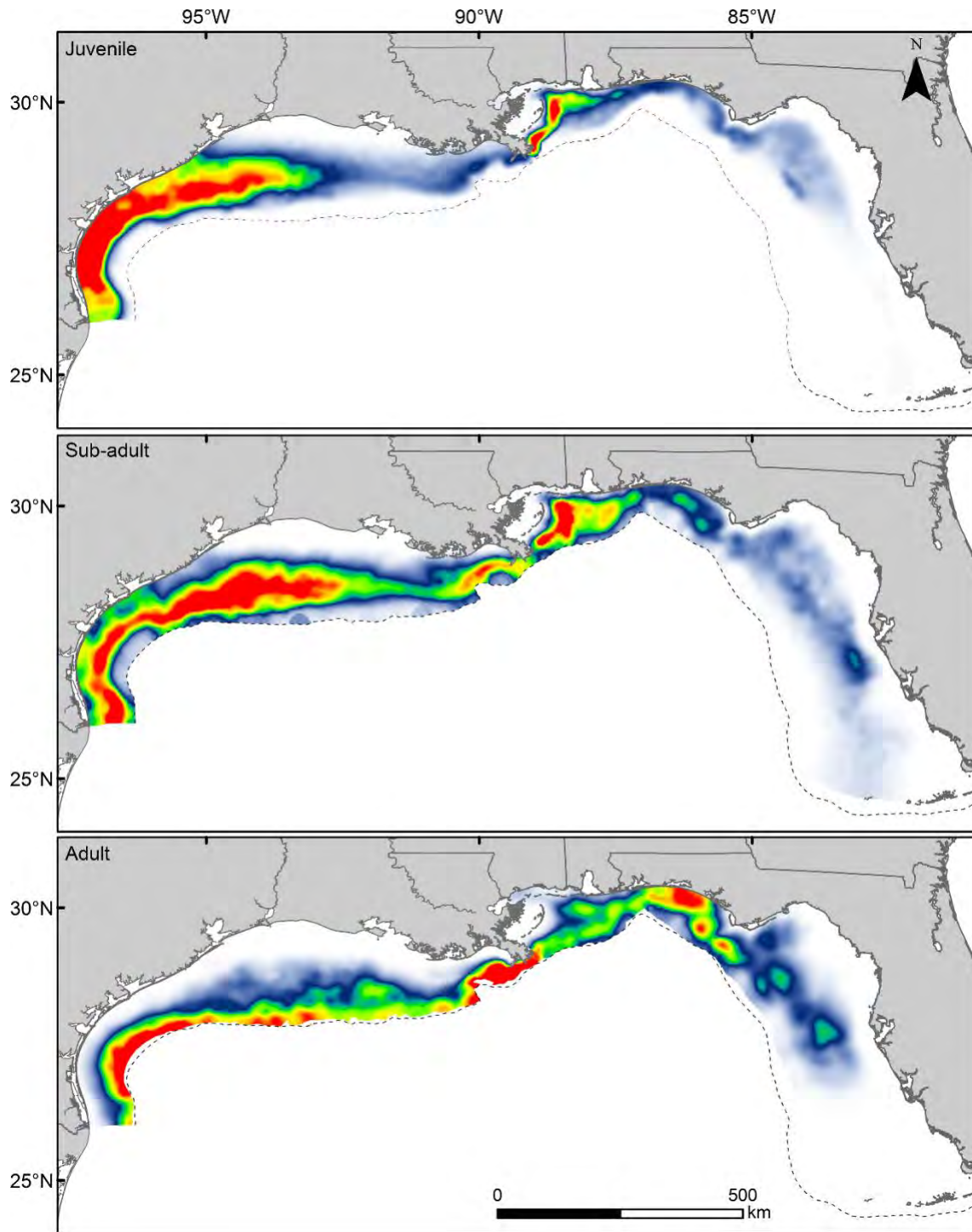


Figure 7: Karnauskas & Paris, SEDAR74-SID-02

Release Region	Recapture Region			
	FL	AL	TX East	TX West
FL	95	0	0	0
AL	2	86	0	0
TX_east	0	0	105	0
TX_west	0	0	0	83



**Figure 8:** Recapture regions from The Great Red Snapper Count and mean absolute distance between tagging and recapture locations.



**Figure 9:** From Dance and Rooker 2019. Ontogenetic movement of red snapper juveniles (top), sub-adult (middle), and adult (bottom).



### 2.2.7 References

- Addis, D. T., W. F. Patterson III, and M. A. Dance. 2016. The potential for unreported artificial reefs to serve as refuges from fishing mortality for reef fishes. *North American Journal of Fisheries Management* 36(1):131-139.
- Allman, R.J., G.R. Fitzhugh, K.J. Starzinger and R.A. Farsky. 2005. Precision of age estimation in red snapper (*Lutjanus campechanus*). *Fisheries Research*. 73:123-133.
- Allman, R. J., L. A. Lombardi-Carlson, G. R. Fitzhugh, and W.A. Fable. 2002. Age structure of red snapper (*Lutjanus campechanus*) in the Gulf of Mexico by fishing mode and region. *Proceedings of the Gulf and Caribbean Fisheries Institute* 53:482–495.
- Brown-Peterson, N. J., K. M. Burns, and R. M. Overstreet. 2009. Regional differences in Florida red snapper reproduction. *Proceedings of the Gulf and Caribbean Fisheries Institute* 61:149–155.
- Brown-Peterson, N. J., C. R. Peterson, and G. R. Fitzhugh. 2019. Multidecadal meta-analysis of reproductive parameters of Red Snapper (*Lutjanus campechanus*) in the northern Gulf of Mexico. *Fishery Bulletin* 117:37–49.
- Dance, M.A. and J. R. Rooker. 2019. Cross-shelf habitat shifts by red snapper (*Lutjanus campechanus*) in the Gulf of Mexico. *PLoS ONE* 14 (3): e0213506.
- Fischer, A. J., M. S. Baker Jr., and C. A. Wilson. 2004. Red snapper (*Lutjanus campechanus*) demographic structure in the northern Gulf of Mexico based on spatial patterns in growth rates and morphometrics. *Fishery Bulletin*. 102:593–603.
- Friess, C. S. Lowerre-Barbieri, G.R. Poulakis, N. Hammerschlag, and others. 2021. Regional-scale variability in the movement ecology of marine fishes revealed by an integrative acoustic tracking network. *Marine Ecology Progress Series* 663:157-177.
- Gallaway, B.J., and J.C. Cole. 1999a. Reduction of juvenile red snapper bycatch in the US Gulf of Mexico shrimp trawl fishery. *North American Journal of Fisheries Management* 19: 342-255. SEDAR74-RD-81. SEDAR, North Charleston, SC.
- Gallaway, B.J., and J.C. Cole. 1999b. Delineation of essential habitat for juvenile red snapper in the northwestern Gulf of Mexico. *Transactions of the American Fisheries Society* 128: 713-726. SEDAR74-RD-83. SEDAR, North Charleston, SC.
- Gallaway, B.J., S.T. Szedlmayer, and W. J. Gazey. 2009. A life history review for red snapper in the Gulf of Mexico with an evaluation of the importance of offshore petroleum platforms and other artificial reefs. *Reviews in Fisheries Science* 17(1): 48-67. SEDAR74-RD-82. SEDAR, North Charleston, SC.
- Hanisko, D.S., J. Lyczkowski-Shultz and G. W. Ingram. 2007. Indices of larval red snapper (*Lutjanus campechanus*) occurrence and abundance for use in stock assessment. Pages 285– 300. Edited by: W. F. Patterson, J. H. Cowan, G. R. Fitzhugh, D. L. Nieland. In *Red snapper ecology and*

- fisheries in the U.S. Gulf of Mexico, American Fisheries Society, Bethesda, Maryland, Symposium 60.
- Johnson, D. R., H. M. Perry, J. Lyczkowski-Shultz, D. Hanisko. 2009. Red snapper larval transport in the Gulf of Mexico. *Transactions of the American Fisheries Society* 138:3, 458-470.
- Karnauskas, M. and C. B. Paris. 2021. A Lagrangian biophysical modeling framework informs stock structure and spawning-recruitment of red snapper (*Lutjanus campechanus*) in the northern Gulf of Mexico. SEDAR74-SID-02. SEDAR, North Charleston, SC. 9 pp.
- Kulaw, D. H., J. H. Cowan, and M. W. Jackson. 2017. Temporal and spatial comparisons of the reproductive biology of northern Gulf of Mexico (USA) Red Snapper (*Lutjanus campechanus*) collected a decade apart. *PLoS ONE* 12(3):e0172360.
- Lowerre-Barbieri, S., L. Crabtree, T.S. Switzer, and R.H. McMichael. 2012. Spatio-temporal dynamics in red snapper reproduction on the West Florida Shelf, 2008-2011. SEDAR31-DW15. SEDAR, North Charleston, SC. 12 pp.
- Mitchell, K.M., T. Henwood, G.R. Fitzhugh and R.J. Allman. 2004. Distribution, abundance and age structure of red snapper (*Lutjanus campechanus*) caught on research longlines in the U.S. Gulf of Mexico. *Gulf of Mexico Science*, 22(2): 164-172.
- Patterson, W. F. III and J. H. Cowan. 2003. Site Fidelity and Dispersion of Red Snapper. In *American Fisheries Society Symposium* (Vol. 36, pp. 181-193).
- Patterson III, WF, J.C. Watterson, R. L. Shipp, and J. H. Cowan Jr. 2001. Movement of tagged red snapper in the northern Gulf of Mexico. *Transactions of the American Fisheries Society* 130(4): 533-545.
- Porch, C. E., G. R. Fitzhugh, E. T. Lang, H. M. Lyon, and B. C. Linton. 2015. Estimating the dependence of spawning frequency on size and age in Gulf of Mexico Red Snapper. *Marine and Coastal Fisheries: Dynamics, Management, and Ecosystem Science* 7:233–2245.
- Saari, C. R., J. H. Cowan Jr., and K.M. Boswell. 2014. Regional differences in the age and growth of Red Snapper (*Lutjanus campechanus*) in the U.S. Gulf of Mexico. *U.S. National Marine Fisheries Service Fishery Bulletin* 112:261–273.
- Stunz, G. W., W. F. Patterson III, S. P. Powers, J. H. Cowan, Jr., J. R. Rooker, R. A. Ahrens, K. Boswell, L. Carleton, M. Catalano, J. M. Drymon, J. Hoenig, R. Leaf, V. Lecours, S. Murawski, D. Portnoy, E. Saillant, L. S. Stokes., and R. J. D. Wells. 2021. Estimating the Absolute Abundance of Age-2+ Red Snapper (*Lutjanus campechanus*) in the U.S. Gulf of Mexico. Mississippi-Alabama Sea Grant Consortium, NOAA Sea Grant. 303 pages.

### 2.3 GENETICS WORKING GROUP

Genetics Workgroup Appointed Participants Eric Saillant (Chair, USM), David Portnoy (TAMU-CC), Steve Cadrin (UMASS Dartmouth), John Mareska (GMFMC SSC), Nathan Putman (LGL Ecological Associates)

Genetics Workgroup Observer: LaTreese Denson (NOAA)

#### 2.3.1 Literature and Data Review and Evaluation

The genetics working group reviewed published literature and relevant to the genetic population structure of Red Snapper in the Gulf of Mexico during Teams Meetings and email communications.

Working documents that were reviewed by the workgroup included the following 6 papers (in publication date chronological order):

Pruett C.L., Saillant E., Gold J.R. 2005. Historical population demography of red snapper (*Lutjanus campechanus*) from the northern Gulf of Mexico based on analysis of sequences of mitochondrial DNA. *Marine Biology* 147: 593-602.

Gold J.R., Saillant E. 2007. Population structure of red snapper in the northern Gulf of Mexico. *American Fisheries Symposium* 60 ch. 13. 15pp.

Saillant E., Bradfield S.C., Gold J.R. 2010. Genetic variation and spatial autocorrelation among young-of-the-year red snapper (*Lutjanus campechanus*) in the northern Gulf of Mexico. *ICES Journal of Marine Science* 67: 1240-1250.

Hollenbeck C.M., Portnoy D.S., Saillant E., Gold J.R. 2015. Population structure of red snapper (*Lutjanus campechanus*) in U.S. waters of the western Atlantic Ocean and the northeastern Gulf of Mexico. *Fisheries Research* 172: 17-25.

Puritz J.B., Gold J.R., Portnoy D.S. 2016. Fine-scale partitioning of genomic variation among recruits in an exploited fishery: causes and consequences. *Scientific Reports* 6:36095.

Portnoy D.S. 2017. Stock structure, connectivity, and effective population size of red snapper (*Lutjanus Campechanus*) in U.S. waters of the Gulf of Mexico. Final report Marfin award # NA12NMF4330093

Additional published genetic studies of red snapper in the Gulf of Mexico reviewed by the group did not bring additional information due to limitations of the datasets used in terms of sample sizes, numbers of sampling localities, or marker systems so the below report focuses primarily on these 6 papers.

Additional documents discussed by the panel included

SEDAR52-WP-20: Karnauskas, Walter and Paris, Use of the Connectivity Modeling System to estimate movements of red snapper (*Lutjanus campechanus*) recruits in the northern Gulf of Mexico

## Document Review

Pruett et al. 2005. Historical population demography of red snapper (*Lutjanus campechanus*) from the northern Gulf of Mexico based on analysis of sequences of mitochondrial DNA

### Approach:

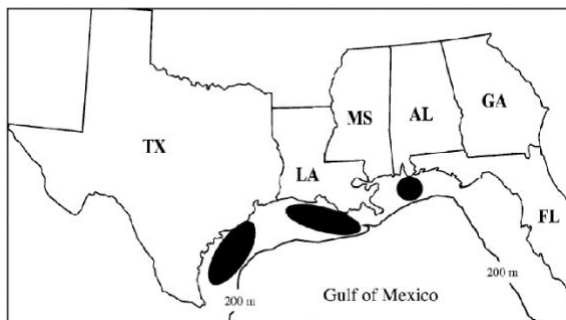
Stock structure and demographic history of red snapper in the northern Gulf of Mexico (Gulf) was analyzed based on mitochondrial (mt) DNA sequences from 360 individuals sampled from four cohorts (year classes) at three localities across the northern Gulf (Alabama, Louisiana and Texas).

### Findings:

- Exact tests of genetic homogeneity and analysis of molecular variance both among cohorts within localities and among localities were non-significant.
- Nested clade analysis provided evidence of different temporal episodes of both range expansion and restricted gene flow with isolation-by-distance.
- A mismatch distribution of pairwise differences among mtDNA haplotypes and a maximum-likelihood coalescence analysis indicated a population expansion phase that dated to the Pleistocene and probably represents (re)colonization of the continental shelf following glacial retreat.

### Interpretations

- **The spatial distribution of red snapper in the northern Gulf appears to have a complex history that likely reflects glacial advance/retreat, habitat availability and suitability, and hydrology.**
- Habitat availability/suitability and hydrology may partially restrict gene flow among present-day red snapper in the northern Gulf and give rise to a metapopulation structure with variable demographic connectivity.
- This type of population structure may be difficult to detect with commonly used, selectively neutral genetic markers.



Gold and Saillant 2007. Population Structure of Red Snapper in the Northern Gulf of Mexico;



Approach

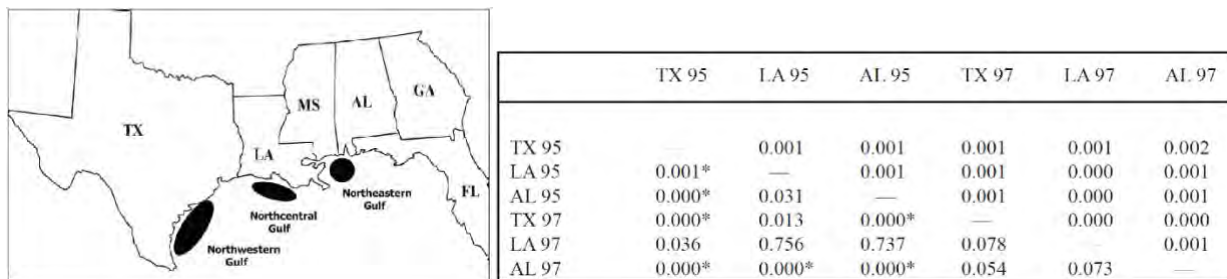
Genetic variation was inferred at 19 nuclear-encoded microsatellite loci and a 590 bp protein-coding fragment of mt DNA were assayed among Gulf red snapper sampled from four cohorts at each of three offshore localities (12 samples total, 576 to 758 samples per region for the microsatellite dataset, 90 samples per region for the mtDNA dataset) in the northern Gulf of Mexico.

Findings

- Significant heterogeneity in allele and genotype distributions among samples was detected at four microsatellites
- Six of seven ‘significant’ pairwise comparisons between samples revealed the heterogeneity to be temporal rather than spatial.
- Nested-clade analysis of mtDNA variants indicated different temporal episodes of range expansion and isolation by distance.

Interpretations

- **Collectively, the findings are consistent with the hypothesis that red snapper in the northern Gulf occur as a network (or metapopulation) of semi-isolated assemblages that may be demographically independent over the short term, yet over the long term can influence each other’s demographics via gene flow.**
- This type of population structure may be difficult to detect with commonly used, selectively neutral genetic markers.



Saillant, E., Bradfield, S. C., and Gold, J. R. 2010. Genetic variation and spatial autocorrelation among young-of-the-year red snapper (*Lutjanus campechanus*) in the northern Gulf of Mexico. – ICES Journal of Marine Science, 67: 1240–1250.

Approach

Temporal and spatial genetic variations at 18 nuclear-encoded microsatellites were assayed among age-0 red snapper, sampled from the 2004 and 2005 cohorts along the northcentral and western Gulf of Mexico during Seemap groundfish surveys and from a mixed-age group sampled off northwest Florida. Samples were grouped in five regions separated by un-sampled areas.

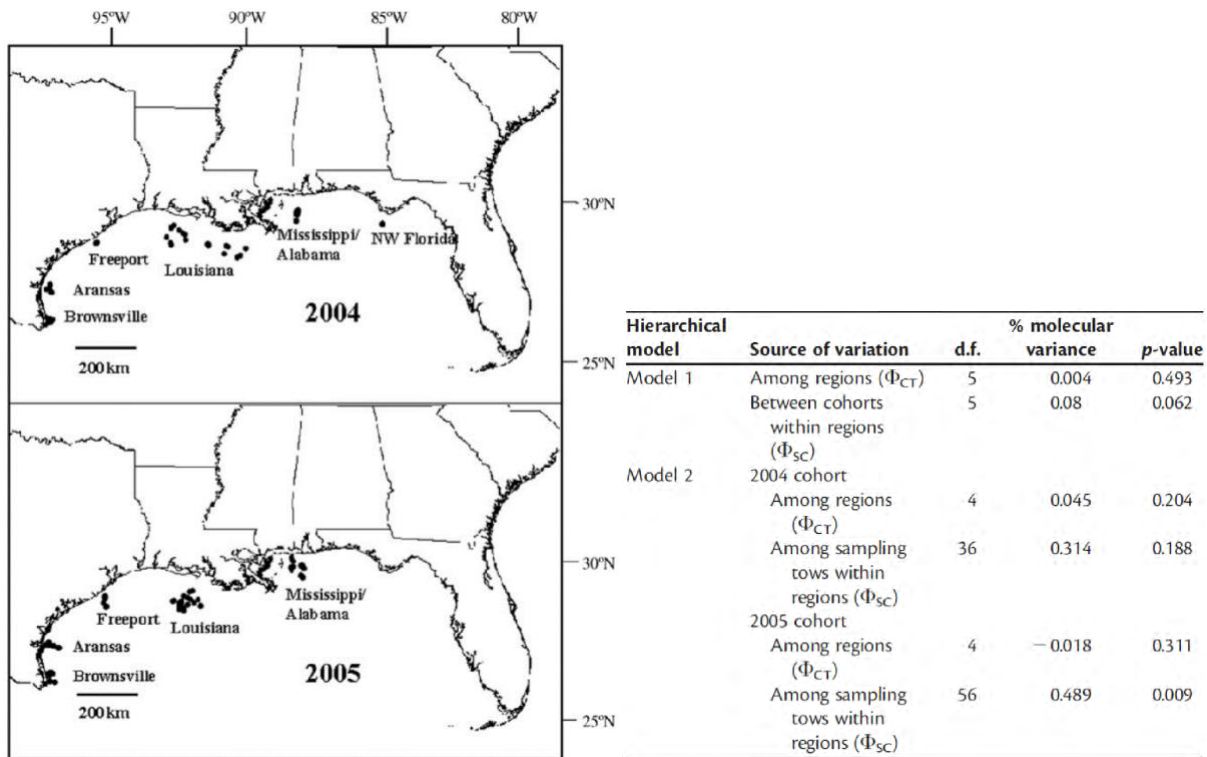
Findings

- Hierarchical analysis of molecular variance revealed genetic heterogeneity among habitat patches within regions, but not among regions.

- A significant, positive spatial autocorrelation of microsatellite genotypes among fish sampled within the geographic range 50–100 km was detected.

Interpretations

- **The results of the study demonstrate that spatial genetic structuring among young-of-the-year red snapper in the Gulf occurs at small geographic scales consistent with restricted larval dispersal and isolation by distance and is consistent with a metapopulation stock-structure model of partially connected populations**
- This accentuates the importance of maintaining healthy local spawning populations of red snapper in all regions across the northern Gulf.



Hollenbeck et al. 2015. Population structure of red snapper (*Lutjanus campechanus*) in U.S. waters of the western Atlantic Ocean and the northeastern Gulf of Mexico

Approach

Population structure of adult red snapper from 8 localities in the southeastern coast of the United States (Atlantic) and the northeastern Gulf of Mexico (Gulf) was assessed using genotypes at 16 nuclear-encoded microsatellites (46 to 101 samples per locality) and mtDNA haplotypes of the NADH dehydrogenase4 (ND4) gene (20 samples per locality).

Findings

- Initial tests (FST-based, hierarchical AMOVA) of spatial genetic homogeneity within and between regions were non-significant, consistent with a single population or stock of red snapper in the Atlantic and Gulf.

- Inferences derived from other statistical approaches were consistent with genetic and/or demographic differences within and between the two regions.
- The estimated, average, long-term migration rate between the two regions (0.27%) was well less than the 10% rate below which populations can respond independently to environmental perturbation.
- Comparisons of global estimates of average, long-term effective size ( $N_{eLT}$ ) with estimates from individual sample localities indicated **genetic heterogeneity within both the Atlantic and Gulf.**

#### Interpretations

- These results **paralleled those of prior genetic studies of red snapper from the Gulf (a network of partially connected demographic assemblages homogenized by periodic gene flow, see above).**
- Future genetics studies and other work on red snapper in both the Atlantic and Gulf should include approaches to identify demographically independent units within each region and assess their size, patterns of connectivity, and contribution to the fishery.
- Monitoring global and/or local effective size also should be considered.



Puritz et al. 2016 Fine-scale partitioning of genomic variation among recruits in an exploited fishery: causes and consequences

#### Approach

Surveyed variation in 7,382 SNPs in red snapper young-of-the-year sampled at six localities (sample sizes between 18 and 37 per locality, average 27) and in adults sampled at two localities in the northern Gulf of Mexico (sample sizes 31 and 35).

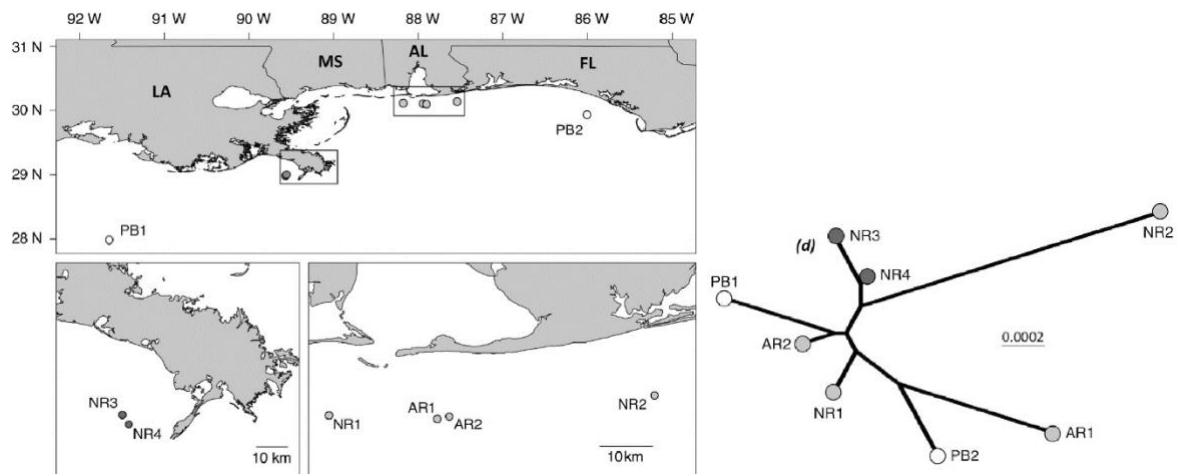
#### Findings

- Significant genetic heterogeneity was detected between the two adult samples, separated by ~600 km, and at spatial scales less than five kilometers among samples of YOY.

- **Genetic differences between YOY samples and between YOY samples and adult samples were not associated with geographic distance, and a genome scan revealed no evidence of loci under selection.**
- Estimates of the effective number of breeders, allelic richness, and relatedness within YOY samples were not consistent with sweepstakes recruitment.

#### Interpretations

- The data demonstrate, at least within one recruitment season, that multiple pulses of recruits originate from distinct groups of spawning adults, even at small spatial scales.
- For exploited species with this type of recruitment pattern, protection of spawning adults over wide geographic areas may be critical for ensuring productivity and stability of the fishery by maintaining larval supply and connectivity.



Adults no shading, YOY shaded by location

#### Portnoy. 2017. Stock Structure, Connectivity, and Effective Population Size of Red Snapper (*Lutjanus Campechanus*) In U.S. Waters of The Gulf Of Mexico.

Three concurrent subprojects were completed with the common goal of providing information about stock structure and genetic demography of Gulf red snapper using a cutting-edge, next-generation sequencing approach. Subproject 1 aimed to develop a variant calling pipeline specifically for population genomic applications and used in the other project components. Subproject 2 was published and discussed above (Puritz et al. 2016). Subproject 3 focused on assessing Populations structure of red snapper in the U.S Atlantic and Gulf of Mexico

#### Approach (Subproject 3)

Diversity was assessed within and among 11 geographic samples of mixed-age red snapper including localities on the East coast, northeastern, central and western gulf and two localities in the southern Gulf (samples sizes between 20 and 38 per location, average 29).

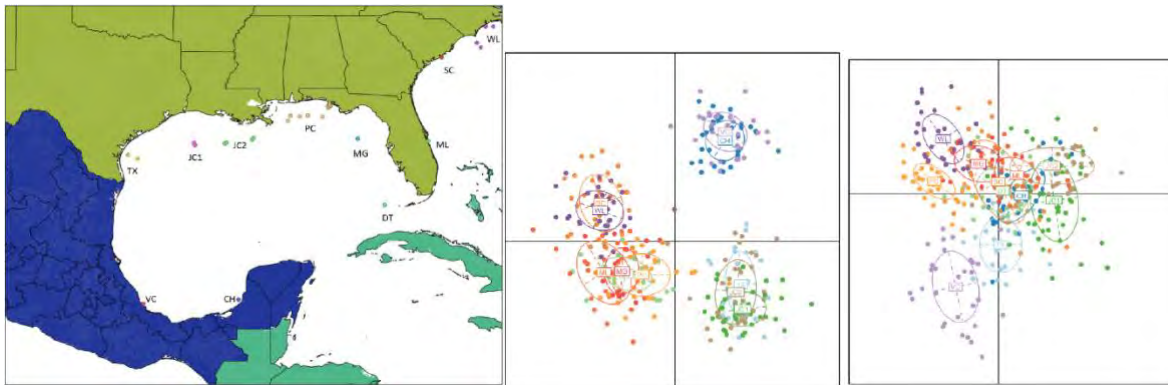
#### Findings

- Within sample diversity was similar among samples
- Eighteen outlier loci, putatively under directional selection were identified.

- All tests of global heterogeneity were significant but estimates of pairwise  $F_{ST}$  for neutral and outlier data sets did not reveal interpretable patterns.
- **Spatial analysis of principal components (sPCA) indicated global structuring and suggested that samples were best grouped into four regions (Carolinas, Florida, western Gulf and southern Gulf) or two regions (Carolinas and Florida, western and southern Gulf) depending on the connection network used.**
- The four-region model was supported by discriminant analysis of principle components (DAPC) and estimates of pairwise  $F_{ST}$  between the four regions were significant for the outlier data set but not for the neutral data.
- Similarly, for the two-region model, estimates of pairwise  $F_{ST}$  were significant for the outlier dataset and not significant for the neutral data set.
- Estimates of migration using two methodologies suggested rates generally below 10% and favored movement into Florida.

#### Interpretations

- Red snapper are not genetically homogenous throughout U.S. waters.
- Gulf of Mexico may be comprised of two stocks but there was not a strong consensus across analyses based on the neutral data set.
- This may be due to non-equilibrium conditions in Gulf red snapper, i.e. recent range expansion associate with the end of the last glacial period, or high connectivity metapopulation structure.



#### 2.3.2 Group conclusions

The group discussed that collectively, all available information consistently indicates that the Gulf of Mexico is not a single unit. The lack of clarity in stock structure in terms of number of units and their delineation is due to a number of factors including the large population size of red snapper which leads to slow divergence among regions coupled with periodic gene flow which contributes to erasing genetic differences.

The occurrence of two units in US Gulf waters was suggested by the most recent study but attempts to delineate regions using spatially explicit models have been unsuccessful (Portnoy et al. 2017).

Demographic analyses indicate that local recruitment results from distinct pools (Puritz et al. 2016). However, spatial autocorrelation of genotypes and isolation by distance were only detected in juveniles when sampling was continuous along the shelf (Saillant et al. 2010) suggesting adult movements are contributing to gene flow.

Overall, no clear recommendation on stock delineation can be made based on available data and the group recommended considering other sources of information including tagging and larval dispersal models (e.g. SEDAR52-WP20).

The group recognizes the limitation of sample sizes in a number of the older studies and the more recent ones (yet partially compensated by the large number of loci for the latter) and recommends taking advantage of the recent extensive genetic sampling across the Gulf on different habitat types to improve current assessments and delineation of stock units.

Finally, the group discussed whether available genetic data provided support in favor of moving of the geographic boundary separating the eastern and western Gulf stocks further East, to the area of Cape San Blas, for the purpose of assessment and management. Analyses conducted during the most comprehensive study to date (Portnoy 2017) were inconclusive regarding the status of the area between Cape San Blas and the Mississippi river with some models showing more affinity of samples from this region with the eastern Gulf (e.g. the 4-groups sPCA analysis in Portnoy 2017) A recent re-analysis of the dataset using a landscape genetics approach indicated a genetic discontinuity along the West Florida Shelf, but could not define an exact boundary ( Portnoy, personal communication)

#### 2.4 LANDINGS AND CPUE WORKING GROUP

##### Names and affiliations of the SEDAR 74 Stock ID Landings and CPUE Working Group.

Jim Tolan (TX Parks & Wildlife Dept.)	Ted Switzer (FL Fish & Wildlife Comm.)
Darin Topping (TX Parks & Wildlife Dept.)	Matthew Nuttall (NOAA Federal)
Steven Scyphers (Northeastern University)	Kelly Fitzpatrick (NOAA Federal)
Kevin Thompson (FL Fish & Wildlife Comm.)	Molly Stevens (NOAA Federal)
Kevin Anson (AL DCNR)	Matthew Campbell (NOAA Federal)
Trevor Moncrief (MS DMR)	Adam Pollack (NOAA Federal)
Jason Adriance (LA WLF)	Kenneth Brennan (NOAA Federal)

Kevin McCarthy (NOAA Federal)  
 Sarina Atkinson (NOAA Federal)  
 Vivian Matter (NOAA Federal)  
 David Hanisko (NOAA Federal)  
 Refik Orhun (NOAA Federal)

Katherine Overly (NOAA Federal)  
 Chris Gardner (NOAA Federal)  
 Jeff Pulver (NOAA Federal)  
 LaTreese Denson (NOAA Federal)

#### 2.4.1 Landings and CPUE Working Group Executive Summary

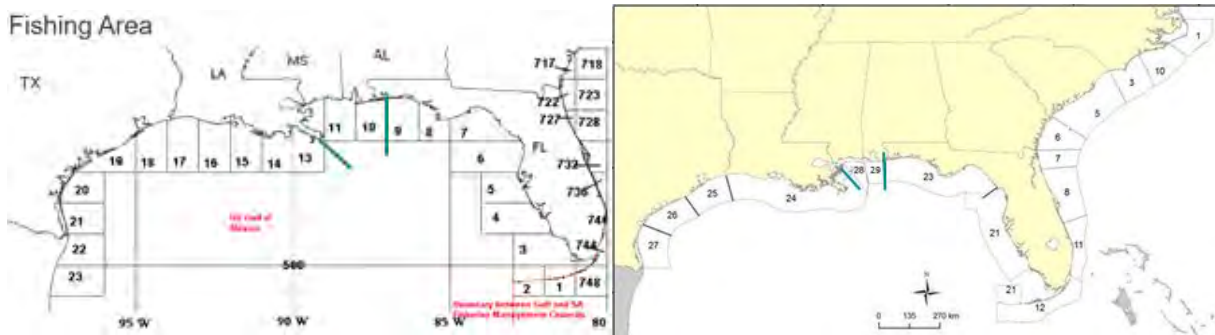
The landings and catch per unit effort (CPUE) working group met remotely via webinars, phone calls, and email communications to determine if the current stock ID boundary for red snapper is still recommended for the upcoming SEDAR 74 Assessment. Currently the boundary for the East and West stocks within the Gulf of Mexico is located between NOAA statistical grids 12 and 13, or the outflow of the Mississippi River. Based on recreational and commercial landings, spatial differences in length frequency distributions, and reef fish video surveys, the members of the landings and CPUE working group felt there was sufficient evidence to warrant either moving the current boundary to the east (for a 2-stock model) or adding an additional stock boundary in the eastern Gulf (for a 3 stock model). While several of the Workgroup members exhibited a preference for Option B based on landings and length frequency differences, others felt Option C was more appropriate given an inability to partition SRHS data at the FL/AL boundary proposed in Option B and a desire to retain the primary LA/MS stock boundary, which was supported by the findings of the life history working group (e.g., larval connectivity; S74-SID-02). We provide the rationales put forward by members of the workgroup to support their preference for either a 2 or 3 stock model, as outlined below.

#### **Stock Boundary Options**

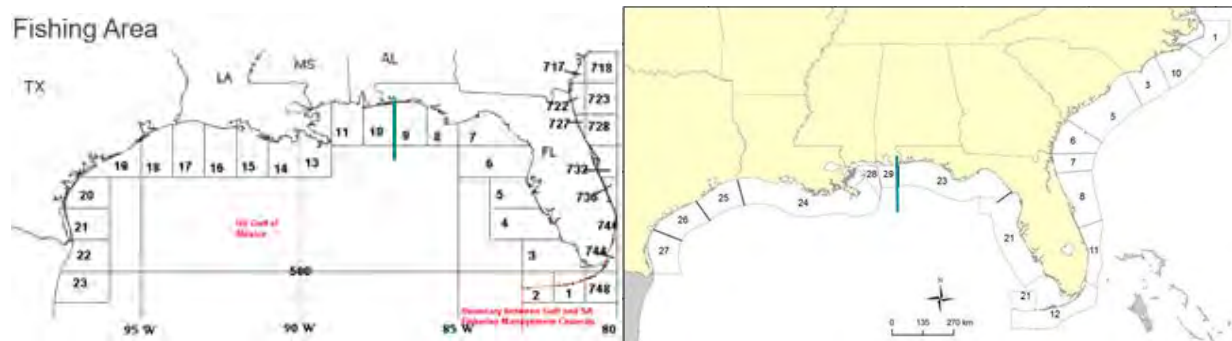
Three new stock boundary options were proposed during the Stock ID workshop in addition to the current boundary (split at the Mississippi River outflow) based on scientific evidence. These options are presented and discussed as they relate to fishery-dependent data, with survey design stratifications and possible stock delineations for various data sources detailed in Figures 1-3. Below, Stock ID options are summarized with the maps on the left representing NMFS Fishing Areas available in commercial data, and the maps on the right representing current SRHS



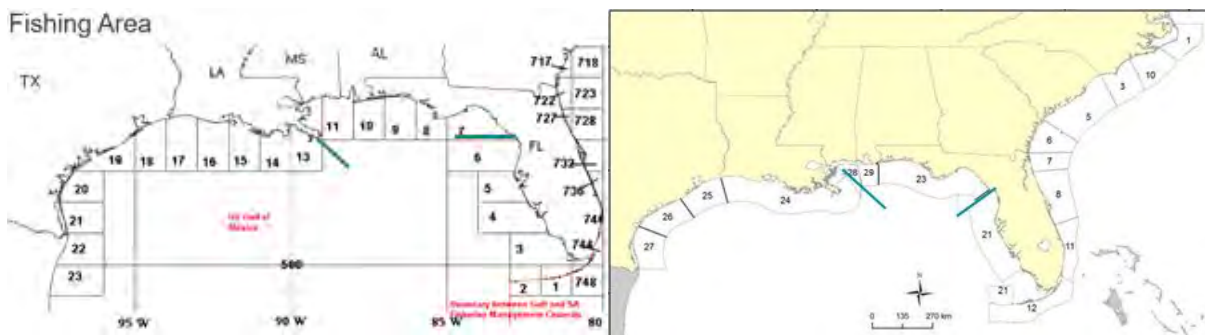
Headboat Areas (please note that SRHS Area 29, the separation of AL from the FL panhandle Area 23, was not incorporated until 2013).



**Option A:** Stock Boundary Option A maintains the current split at the Mississippi River outflow (as in SEDAR 52) and incorporates an additional split for MS/AL where there may be unique fishery dynamics and differing trends of abundance.



**Option B:** Stock Boundary Option B removes the split at the Mississippi and pools MS/AL with TX/LA which share similar trends in abundance.



**Option C:** Stock Boundary Option C maintains the current split at the Mississippi River outflow (as in SEDAR 52) and incorporates an additional split for MS/AL/FL panhandle where there are similar fishery dynamics.



### 2.4.2 General Recreational Landings

General recreational landings of Gulf of Mexico Red Snapper (SEDAR 74-SID-01) are largely concentrated in the northeast, with 32.7% of all private and charter landings between 1981-2019 coming from Alabama and 36.7% from the Florida panhandle (i.e., AL:FL border to the Dixie:Levy county border; see Figs 4 and 5). Louisiana also accounts for an appreciable portion of Red Snapper landings in the Gulf (19.9%). Texas, Mississippi, and other parts of western Florida contribute relatively little to the Gulf-wide recreational landings of Red Snapper (respectively, 2.5%, 4.6%, and 3.5% of Gulf-wide landings since 1981).

The current east-west boundary for Gulf Red Snapper (i.e., those used in SEDAR 52) separates this stock between NMFS stat zones 12 and 13. From the perspective of general recreational landings, this structure largely amounts to separating Louisiana Red Snapper from those in Alabama and the Florida panhandle, which may be necessary to model the general decline in Louisiana landings over time (31.9% of Gulf-wide landings in 1981-1999 and 6.4% since 2000). Shifting the current stock boundary east to include MS and AL (i.e., Option B; two-area model) may therefore inhibit the assessment model from detecting and explaining this trend in Louisiana landings if driven by something other than fishing effort (e.g., fishing behavior). Similarly, general recreational landings of Gulf Red Snapper have also changed in the Florida panhandle, increasing from 19.4% of historic Gulf-wide landings (1981-1999) to 56.2% since 2000. Like Louisiana, this trend may warrant consideration of separating the FL panhandle from AL, as is proposed in Option A (i.e., three-area model).

### 2.4.3 Southeast Region Headboat Survey (SRHS)

Red snapper landings in the SRHS are concentrated in TX (74.1% of Gulf-wide landings, 1986-2019), followed by NWFL/AL (18.8% of Gulf-wide landings, 1986-2019). LA, MS (added to the SRHS in 2010), and SWFL have consistently accounted for little of the Gulf-wide SRHS landings. SRHS red snapper landings have shifted through time. From 1986-1999 TX accounted for 83.7% of the Gulf-wide SRHS landings while NWFL/AL accounted for 8.2%. From 2000-2019 TX accounted for 56.4% of the Gulf wide SRHS red snapper landings while the NWFL/AL landings increased to 38.1%. The increase in landings in the NWFL/AL region in the SRHS is reflected in the increase in the general recreational fishery. SRHS landings are a relatively small

component of the overall recreational fishery (9.04% of the overall recreational landings). It is also important to note that the SRHS area domains represent the area where the fish were landed, not the waterbody caught.

The spatial analysis of SRHS catch records utilizes the reported primary fishing location for each trip (Klibansky, 2020, Figure 6). This analysis shows the highest CPUEs off of TX and the western coast of LA. However, there are no SRHS selected headboats operating in western LA. Those catches are reported by TX vessels that run longer trips, rather than by vessels operating in eastern LA, and therefore are included in the TX estimated landings. CPUEs in eastern LA, MS, and NWFL/AL are slightly lower, with relatively few red snapper caught per angler hour in SWFL.

#### 2.4.4 Reef Fish Video Surveys

Size composition data and mean CPUE were summarized for three fishery-independent reef fish video surveys to examine potential evidence of stock structure: the MS Labs reef fish survey (shelf-edge reef habitats Gulf-wide), the Panama City reef fish survey (shelf reef habitats of the northeastern Gulf of Mexico), and the FWRI reef fish survey (shelf and shelf-edge reef habitats off the Florida Gulf coast). Observed patterns in CPUE were generally similar among the three western Gulf regions (Texas, West Louisiana, and East Texas) and the North Central region that extended from the mouth of the Mississippi River east to Cape San Blas (Figure 7). In contrast, observed fish were generally larger overall in the Big Bend and South Florida (Cape San Blas to the Florida Keys) than they were in the western or north-central Gulf (Figure 8). In the eastern Gulf of Mexico, clear differences in CPUE trends were evident east and west of Cape San Blas in both the Panama City (Figure 9) and FWRI data (Figure 10). In the FWRI data, trends were similar in both the Mid Peninsula and South Florida regions (Figure 10). Based on summaries of reef fish video survey data, there is little evidence to suggest a clear boundary at the mouth of the Mississippi River. Instead, it appears that there is a distinct break at Cape San Blas (boundary between statistical zones 7 and 8), and potentially a second break at or around Tampa Bay (between statistical zones 5 and 6). However, understanding the difficulties in breaking some data sets at the Cape San Blas boundary, these results may support the exploration of a 3-stock model with one break between zones 10 and 11 and a second break between zones 6 and 7.

#### 2.4.5 Length Compositions of Landings

Length compositions of Red Snapper landings were analyzed at the finest spatial scale possible throughout the Gulf of Mexico for commercial and recreational fleets. These compositions are provided as supplementary information to the Stock Identification Workshop and should not serve as the primary driver for stock structure decisions since these can be influenced by interacting factors other than stock structure, including but not limited to gear selectivity, gear distribution, and fishing behavior.

##### *Commercial*

Commercial size data were supplied through the Trip Interview Program (TIP, n=436,893) and the Fisheries Information Network housed at GSMFC (GulfFIN, n=13,629). These data were reported with one of 21 statistical areas divided along the US Gulf of Mexico coastline (Figure 1).

Commercial length samples were aggregated by fishing areas defined under each of the Stock Boundary Options within the fleet structure utilized in SEDAR52 to display available sample sizes. Vertical Line (VL) gear had sufficient samples in all Stock Boundary Options to estimate nominal length compositions (Table 1). Longline (LL) gear did not have consistent sampling in the Central region from the Stock Boundary Options A & C to support estimation of length compositions for either three-stock model (Table 2). VL was the primary gear type landing Red Snapper, accounting for nearly 95% of commercial length samples, and was used to visualize spatial shifts in length compositions throughout the Gulf. The annually aggregated VL length compositions display a continuous shift from the largest fish landed in the eastern Gulf of Mexico (GOM), the smallest fish in the central GOM, and intermediate sizes in the western GOM (Figure 11).

##### *Recreational*

Recreational data were supplied through the Southeast Regional Headboat Survey (SRHS), Marine Recreational Information Program (MRIP), and GSMFC Fisheries Information Network (GulfFIN). In 2013 SRHS landing areas were reevaluated in order to separate Alabama and Florida data and landings estimates. SRHS areas represent where the fish were landed, rather than the waterbody where the fish were caught (Figure 2). The finest resolution MRIP data can

be compiled is by state, except for Florida, which is subdivided into five sampling domains, three of which are in the Gulf of Mexico (Figure 3).

Recreational length samples were aggregated under each definition of Stock Boundary Options within the same fleet structure utilized in SEDAR52 to display available sample sizes. SRHS headboat samples were truncated to 7 years of data (2013-2019) in Options A and B due to the inability to split AL from the panhandle of FL (i.e. addition of Area 29 in 2013 facilitated these stock boundaries). Stock Boundary Option C had insufficient samples in the eastern region, leaving the current boundary the most viable option for SRHS data (Table 3).

General recreational length data (MRIP and GulfFIN) also had insufficient samples in the eastern region under Stock Boundary Option C for both charterboat (Table 4) and private modes (Table 5), indicating an overall lack of a recreational Red Snapper fishery in this region. By the late 1990s, there are sufficient charterboat length samples to support Options A or B, but the current stock boundary has a more even distribution of sampling and fewer years that dip below the 30 sample size threshold (Table 4, Fig. 12). These issues are exacerbated in the private mode, where more years of data would be dropped under Options A and B due to fewer samples overall compared to charterboat (Table 5, Fig. 13). The current stock boundary results in more even distribution of recreational length samples for estimating compositions compared to other options.

#### 2.4.6 Discussion

The structure of general recreational survey data is amenable to Option A, but this option is problematic for the SRHS data, which did not separate AL and NWFL until 2013 (Figure 2). Additionally, the proposed MS/AL zone in Option A constitutes a relatively small spatial domain, the sampling of which may be inadequate for some abundance indices or composition data in the region. The latter (sample size) constraint in the proposed MS/AL zone may be relaxed by shifting the boundary east, but the resolution at which general recreational catch estimates are available for the Gulf constrains where this boundary could be moved; domain boundaries are currently set around the “Big Bend” region (i.e., Option C; three-area model) and at the Monroe:Collier county border. Additionally, shifting the second boundary east will still require some assumption in how to allocate SRHS catch estimates across FL domains and is still

likely to result in a data poor spatial area (i.e., SWFL vs. MS/AL in Option B). The general recreational data can also support Option B (i.e., two-area model; boundary at 9/10) but this option may impede the modeling of landing trends for Louisiana Red Snapper. Any stock boundaries set in western Florida beyond those mentioned will require an additional assumption in how to allocate general recreational catch estimates across Florida domains. Options A and B will both require assumptions in how to partition SRHS catch estimates (across AL and FL), and these assumptions have yet to be explored. Options A and C are likely to result in data poor areas (Option A effectively creates a MS/AL zone while option C results in a SWFL only zone) for the SRHS data as well as the general recreational data.

In summary, the general recreational landings data for Gulf of Mexico Red Snapper seem to support the following Stock ID boundaries for SEDAR 74:

- Status-Quo (i.e., two-area model) – boundary at NMFS stat zone 12/13
- Option A (i.e., three-area model) – boundaries at NMFS stat zone 12/13 and 9/10
- Option B (i.e., two-area model)- boundary at NMFS stat zone 9/10
- Option C (i.e., three-area model) – boundaries at NMFS stat zones 12/13 and 6/7

Of the proposed options the SRHS can support the following options for SEDAR 74:

- Status-Quo (i.e., two-area model) – boundary at NMFS stat zone 12/13
- Option C (i.e., three-area model) - boundary at NMFS stat zones 12/13 and 6/7

## References :

- Karnauskas, M. and C. B. Paris. 2021. A Lagrangian biophysical modeling framework informs stock structure and spawning-recruitment of red snapper (*Lutjanus campechanus*) in the northern Gulf of Mexico. SEDAR74-SID-02. SEDAR, North Charleston, SC. 9pp.
- Moncrief, Trevor. 2021. Mississippi Red Snapper Data Summary. SEDAR74-SID-04. SEDAR, North Charleston, SC. 16pp.
- Nuttall, Matthew A. and Vivian M. Matter. 2021. Hot Spot Maps of General Recreational Landings for Gulf of Mexico Red Snapper. SEDAR74-SID-01. SEDAR, North Charleston, SC. 9pp.
- Switzer, Theodore S., Adam G. Pollack, Katherine E. Overly, Christopher Gardner, Kevin A. Thompson, Matt Campbell. 2021. Insights into the Spatial Dynamics of Red Snapper in the Gulf of Mexico from Gulf-Wide Fishery Independent Surveys. SEDAR74-SID-03. SEDAR, North Charleston, SC. 27pp.

## 2.4.7 Tables

**Table 1:** Vertical line length samples under the current and alternate Stock Boundary Options.

VL	CURRENT		OPTION A			OPTION B		OPTION C		
	W	E	W	C	E	W	E	W	C	E
1984	3093	963	3093	192	771	3285	771	3093	438	525
1985	3650	634	3650	143	491	3793	491	3650	310	324
1986	2165	1140	2165	912	228	3077	228	2165	912	228
1987	848	699	848	641	58	1489	58	848	641	58
1988	1300	286	1300	136	150	1436	150	1300	182	104
1989	1538	597	1538	487	110	2025	110	1538	519	78
1990	6505	2216	6505	1589	627	8094	627	6505	1989	227
1991	6302	1858	6302	1610	248	7912	248	6302	1823	35
1992	5008	765	5008	733	32	5741	32	5008	733	32
1993	6980	1950	6980	1691	259	8671	259	6980	1880	70
1994	2517	3906	2517	3354	552	5871	552	2517	3824	82
1995	5392	2347	5392	2081	266	7473	266	5392	2298	49
1996	2831	2481	2831	2170	311	5001	311	2831	2389	92
1997	6755	2084	6755	1641	443	8396	443	6755	1918	166
1998	7493	3436	7493	2587	849	10080	849	7493	3314	122
1999	4238	3798	4238	3041	757	7279	757	4238	3382	416
2000	3577	4079	3577	3088	991	6665	991	3577	3916	163
2001	3963	4422	3963	3182	1240	7145	1240	3963	4270	152
2002	5916	4969	5916	3729	1240	9645	1240	5916	4704	265
2003	5125	5623	5125	3919	1704	9044	1704	5125	5249	374
2004	3265	3559	3265	1818	1741	5083	1741	3265	3297	262
2005	3737	3728	3737	1993	1735	5730	1735	3737	3496	232
2006	3802	2841	3802	1763	1078	5565	1078	3802	2601	240
2007	1478	3770	1478	789	2981	2267	2981	1478	3476	294
2008	3129	4070	3129	2573	1497	5702	1497	3129	3884	186
2009	3187	3889	3187	2503	1386	5690	1386	3187	3509	380
2010	4063	4475	4063	2282	2193	6345	2193	4063	3626	849
2011	3718	6606	3718	2974	3632	6692	3632	3718	5808	798
2012	8735	9017	8735	3358	5659	12093	5659	8735	7911	1106
2013	10788	11306	10788	4896	6410	15684	6410	10788	9883	1423
2014	16251	9314	16251	4265	5049	20516	5049	16251	7984	1330
2015	19003	15278	19003	9180	6098	28183	6098	19003	14235	1043
2016	17694	15268	17694	9315	5953	27009	5953	17694	14278	990
2017	17628	11776	17628	6214	5562	23842	5562	17628	10572	1204
2018	12866	13723	12866	7443	6280	20309	6280	12866	12932	791
2019	14121	15373	14121	10540	4833	24661	4833	14121	14290	1083

**Table 2:** Longline length samples under the current and alternate Stock Boundary Options.

LL	CURRENT		OPTION A			OPTION B		OPTION C		
	W	E	W	C	E	W	E	W	C	E
1984	641	405	641	0	405	641	405	641	0	405
1985	248	294	248	8	286	256	286	248	8	286
1986	57	242	57	0	242	57	242	57	6	236
1987	26	139	26	0	139	26	139	26	0	139
1988	39	122	39	0	122	39	122	39	4	118
1989	218	9	218	0	9	218	9	218	0	9
1990	376	359	376	17	342	393	342	376	51	308
1991	109	103	109	0	103	109	103	109	39	64
1992	114	88	114	2	86	116	86	114	2	86
1993	30	138	30	0	138	30	138	30	0	138
1994	3	90	3	18	72	21	72	3	18	72
1995	74	133	74	0	133	74	133	74	0	133
1996	11	76	11	0	76	11	76	11	0	76
1997	63	65	63	0	65	63	65	63	11	54
1998	253	131	253	0	131	253	131	253	0	131
1999	218	281	218	0	281	218	281	218	0	281
2000	515	263	515	0	263	515	263	515	0	263
2001	180	228	180	24	204	204	204	180	47	181
2002	566	275	566	0	275	566	275	566	40	235
2003	259	301	259	19	282	278	282	259	33	268
2004	482	371	482	0	371	482	371	482	29	342
2005	217	439	217	0	439	217	439	217	0	439
2006	448	253	448	0	253	448	253	448	0	253
2007	137	220	137	0	220	137	220	137	93	127
2008	37	466	37	32	434	69	434	37	153	313
2009	67	101	67	29	72	96	72	67	29	72
2010	61	649	61	0	649	61	649	61	1	648
2011	44	592	44	0	592	44	592	44	23	569
2012	157	210	157	0	210	157	210	157	16	194
2013	148	701	148	0	701	148	701	148	14	687
2014	97	1194	97	0	1194	97	1194	97	4	1190
2015	285	886	285	0	886	285	886	285	28	858
2016	166	751	166	11	740	177	740	166	27	724
2017	232	540	232	15	525	247	525	232	43	497
2018	519	671	519	14	657	533	657	519	142	529
2019	1025	883	1025	22	861	1047	861	1025	104	779

**Table 3:** SRHS headboat length sample sizes under the current and alternate Stock Boundary Options.

SRHS	CURRENT		OPTION A			OPTION B		OPTION C		
	W	E	W	C	E	W	E	W	C	E
1986	6252	164	--	--	--	--	--	6252	141	23
1987	5978	192	--	--	--	--	--	5978	191	1
1988	4591	195	--	--	--	--	--	4591	194	1
1989	6314	286	--	--	--	--	--	6314	280	6
1990	4263	333	--	--	--	--	--	4263	330	3
1991	3420	497	--	--	--	--	--	3420	496	1
1992	7872	683	--	--	--	--	--	7872	682	1
1993	7055	385	--	--	--	--	--	7055	385	0
1994	6642	1316	--	--	--	--	--	6642	806	510
1995	8325	441	--	--	--	--	--	8325	441	0
1996	5260	496	--	--	--	--	--	5260	496	0
1997	3996	1139	--	--	--	--	--	3996	1139	0
1998	6556	2156	--	--	--	--	--	6556	2156	0
1999	3284	884	--	--	--	--	--	3284	839	45
2000	3194	1135	--	--	--	--	--	3194	1130	5
2001	2531	653	--	--	--	--	--	2531	648	5
2002	2385	1250	--	--	--	--	--	2385	1250	0
2003	2005	1089	--	--	--	--	--	2005	1086	3
2004	808	544	--	--	--	--	--	808	543	1
2005	1015	303	--	--	--	--	--	1015	301	2
2006	766	481	--	--	--	--	--	766	464	17
2007	768	1280	--	--	--	--	--	768	1264	16
2008	401	1223	--	--	--	--	--	401	1221	2
2009	866	947	--	--	--	--	--	866	911	36
2010	796	708	--	--	--	--	--	796	687	21
2011	978	737	--	--	--	--	--	978	722	15
2012	456	607	--	--	--	--	--	456	575	32
2013	2299	1076	2299	581	495	2880	495	2299	1057	19
2014	4773	2150	4773	1631	519	6404	519	4773	2101	49
2015	4013	2264	4013	1650	614	5663	614	4013	2138	126
2016	3793	706	3793	589	117	4382	117	3793	674	32
2017	2887	832	2887	617	215	3504	215	2887	754	78
2018	3936	744	3936	488	256	4424	256	3936	650	94
2019	3788	1509	3788	560	949	4348	949	3788	1413	96



**Table 4:** Charterboat length sample sizes under the current and alternate Stock Boundary Options.

CB	CURRENT		OPTION A			OPTION B		OPTION C		
	W	E	W	C	E	W	E	W	C	E
1981	22	78	22	62	16	84	16	22	78	0
1982	5	79	5	50	29	55	29	5	79	0
1983	440	165	440	79	86	519	86	440	158	7
1984	219	40	219	2	38	221	38	219	16	24
1985	134	35	134	34	1	168	1	134	34	1
1986	358	169	358	121	48	479	48	358	160	9
1987	265	468	265	250	218	515	218	265	467	1
1988	29	348	29	287	61	316	61	29	345	3
1989	29	156	29	147	9	176	9	29	148	8
1990	48	163	48	150	13	198	13	48	163	0
1991	294	735	294	687	48	981	48	294	734	1
1992	369	1745	369	1526	219	1895	219	369	1741	4
1993	153	668	153	411	257	564	257	153	668	0
1994	166	444	166	346	98	512	98	166	444	0
1995	192	245	192	187	58	379	58	192	245	0
1996	193	219	193	160	59	353	59	193	217	2
1997	162	1188	162	534	654	696	654	162	1183	5
1998	297	2880	297	1301	1579	1598	1579	297	2854	26
1999	126	7352	126	3666	3686	3792	3686	126	7341	11
2000	187	7735	187	2974	4761	3161	4761	187	7732	3
2001	130	6451	130	2866	3585	2996	3585	130	6436	15
2002	683	9995	683	5606	4389	6289	4389	683	9992	3
2003	759	9558	759	5422	4136	6181	4136	759	9512	46
2004	964	6843	964	3160	3683	4124	3683	964	6836	7
2005	846	6389	846	2727	3662	3573	3662	846	6373	16
2006	1110	5135	1110	2264	2871	3374	2871	1110	5118	17
2007	1450	4768	1450	1390	3378	2840	3378	1450	4754	14
2008	824	2107	824	546	1561	1370	1561	824	2090	17
2009	879	1418	879	703	715	1582	715	879	1395	23
2010	135	1708	135	317	1391	452	1391	135	1647	61
2011	672	1654	672	641	1013	1313	1013	672	1652	2
2012	775	1732	775	804	928	1579	928	775	1708	24
2013	1017	920	1017	399	521	1416	521	1017	879	41
2014	486	598	486	221	377	707	377	486	505	93
2015	882	1181	882	404	777	1286	777	882	999	182
2016	760	1597	760	816	781	1576	781	760	1528	69
2017	1077	1546	1077	814	732	1891	732	1077	1359	187
2018	1128	1662	1128	789	873	1917	873	1128	1358	304
2019	746	2504	746	1191	1313	1937	1313	746	2158	346

**Table 5:** Private length sample sizes under the current and alternate Stock Boundary Options.

PR	CURRENT		OPTION A			OPTION B		OPTION C		
	W	E	W	C	E	W	E	W	C	E
1981	35	111	35	51	60	86	60	35	81	30
1982	153	82	153	20	62	173	62	153	80	2
1983	462	15	462	8	7	470	7	462	8	7
1984	437	21	437	15	6	452	6	437	15	6
1985	631	11	631	3	8	634	8	631	6	5
1986	389	16	389	7	9	396	9	389	11	5
1987	452	175	452	60	115	512	115	452	174	1
1988	490	32	490	9	23	499	23	490	16	16
1989	317	13	317	4	9	321	9	317	5	8
1990	349	57	349	49	8	398	8	349	55	2
1991	449	181	449	179	2	628	2	449	180	1
1992	664	496	664	482	14	1146	14	664	495	1
1993	802	231	802	202	29	1004	29	802	231	0
1994	1101	167	1101	150	17	1251	17	1101	167	0
1995	1867	113	1867	98	15	1965	15	1867	112	1
1996	1425	106	1425	93	13	1518	13	1425	103	3
1997	1348	179	1348	172	7	1520	7	1348	179	0
1998	1159	140	1159	126	14	1285	14	1159	140	0
1999	756	751	756	629	122	1385	122	756	742	9
2000	966	426	966	341	85	1307	85	966	426	0
2001	832	496	832	391	105	1223	105	832	496	0
2002	1349	960	1349	882	78	2231	78	1349	957	3
2003	1620	787	1620	704	83	2324	83	1620	784	3
2004	1495	586	1495	502	84	1997	84	1495	576	10
2005	2088	334	2088	272	62	2360	62	2088	327	7
2006	2424	406	2424	290	116	2714	116	2424	401	5
2007	1431	404	1431	155	249	1586	249	1431	396	8
2008	1126	269	1126	128	141	1254	141	1126	263	6
2009	1345	281	1345	234	47	1579	47	1345	278	3
2010	1005	253	1005	132	121	1137	121	1005	249	4
2011	945	286	945	176	110	1121	110	945	279	7
2012	1032	423	1032	249	174	1281	174	1032	418	5
2013	1355	469	1355	264	205	1619	205	1355	466	3
2014	1766	887	1766	405	482	2171	482	1766	879	8
2015	1845	885	1845	446	439	2291	439	1845	884	1
2016	1382	1127	1382	439	688	1821	688	1382	1111	16
2017	1833	1777	1833	702	1075	2535	1075	1833	1365	412
2018	2218	1261	2218	582	679	2800	679	2218	1188	73
2019	2507	1956	2507	1228	728	3735	728	2507	1890	66

2.4.8 Figures

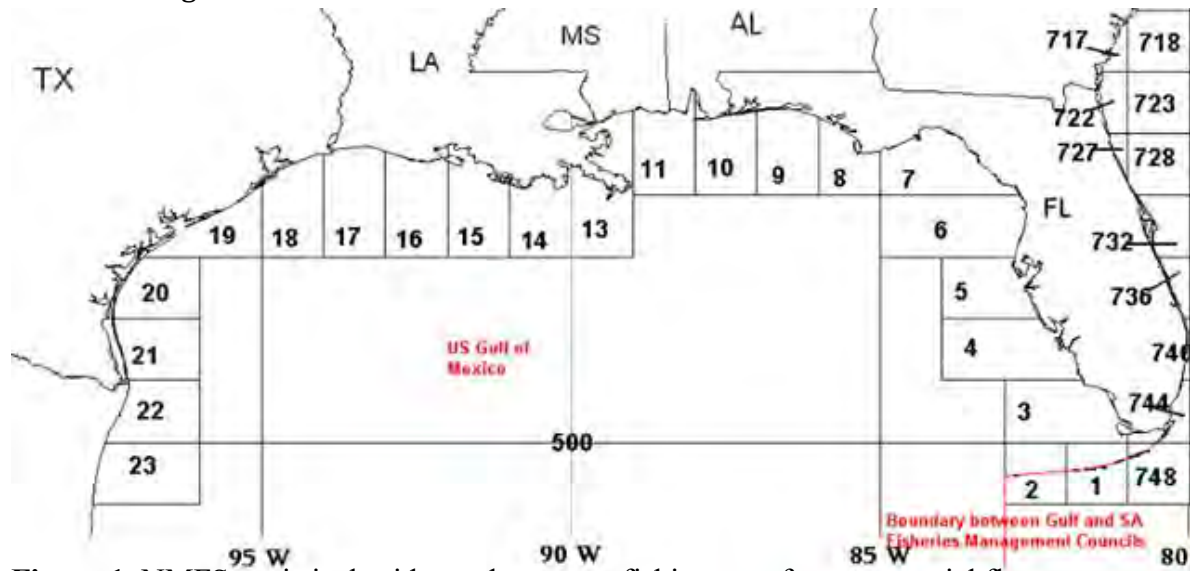
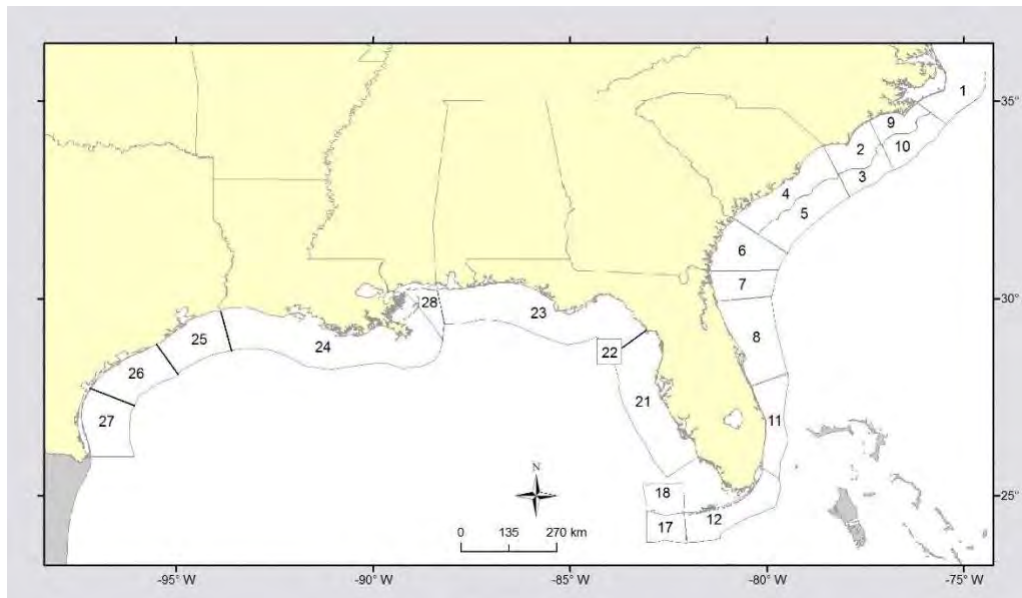
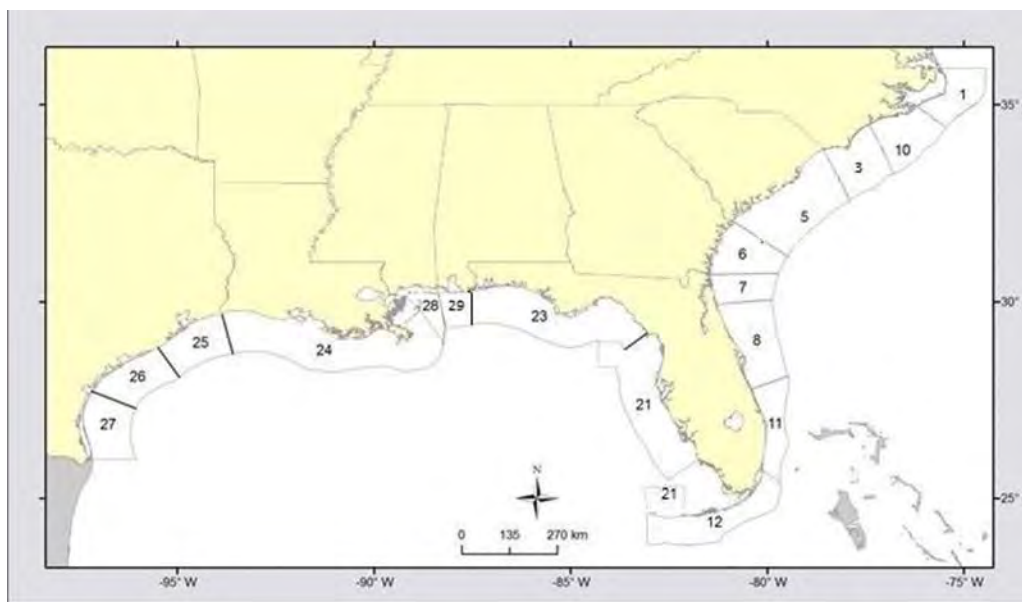


Figure 1: NMFS statistical grids used to report fishing area for commercial fleets.

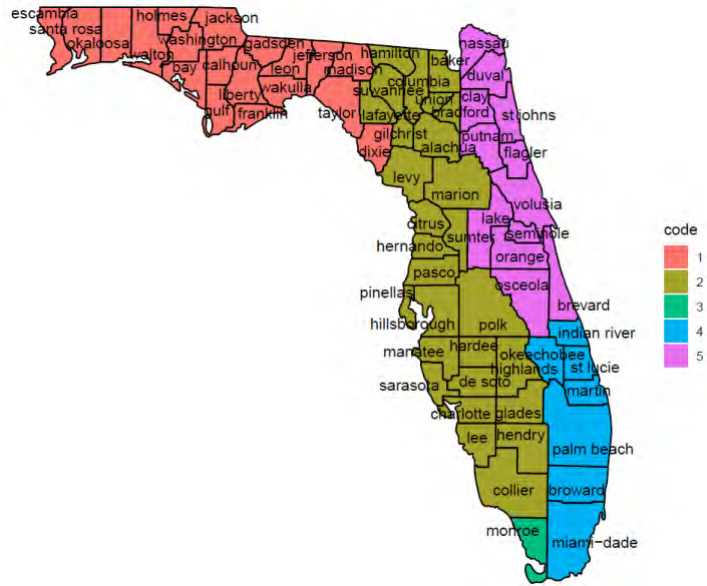
a)



b)

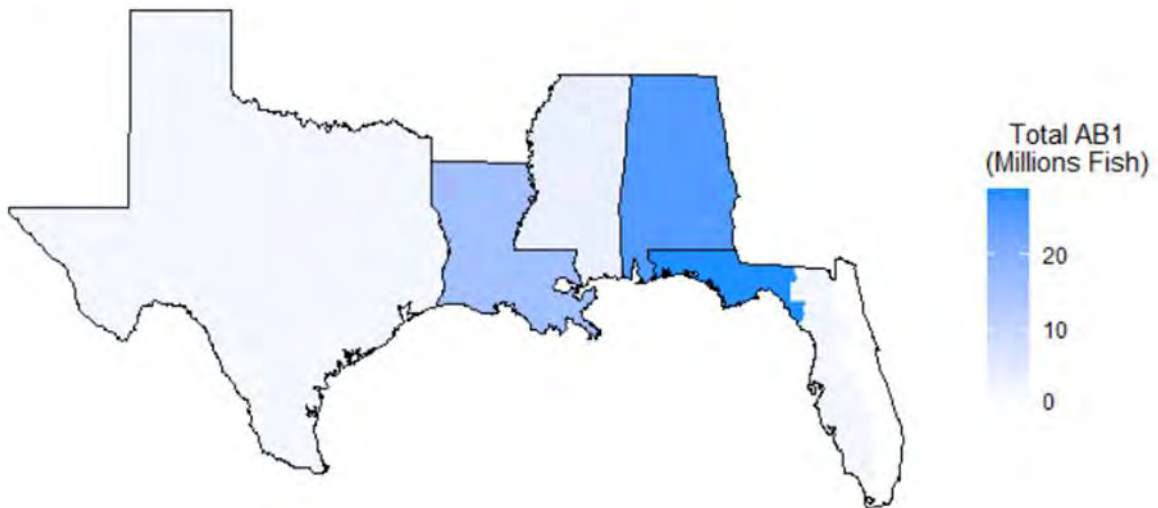


**Figure 2.** Southeast Regional Headboat Survey statistical areas (1972-2012) (a, top panel) and following the revision 2013-present (b, bottom panel). In 2013 Area 29 was separated from Area 23 in order to allow for separation of AL vessel data from NWFL vessel data.

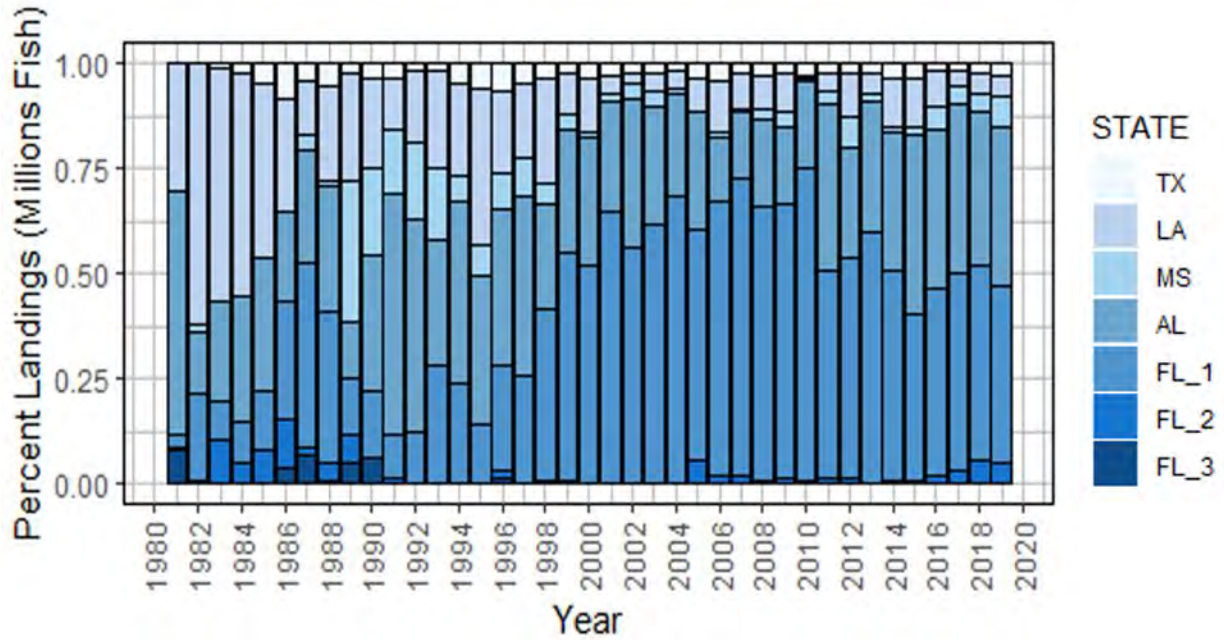


**Figure 3.** Florida areas in the MRIP survey design, where samples from the Atlantic coast (areas 4 and 5) were deleted and areas 2/3 were aggregated for figures. All other Gulf MRIP stratifications are at state boundaries.

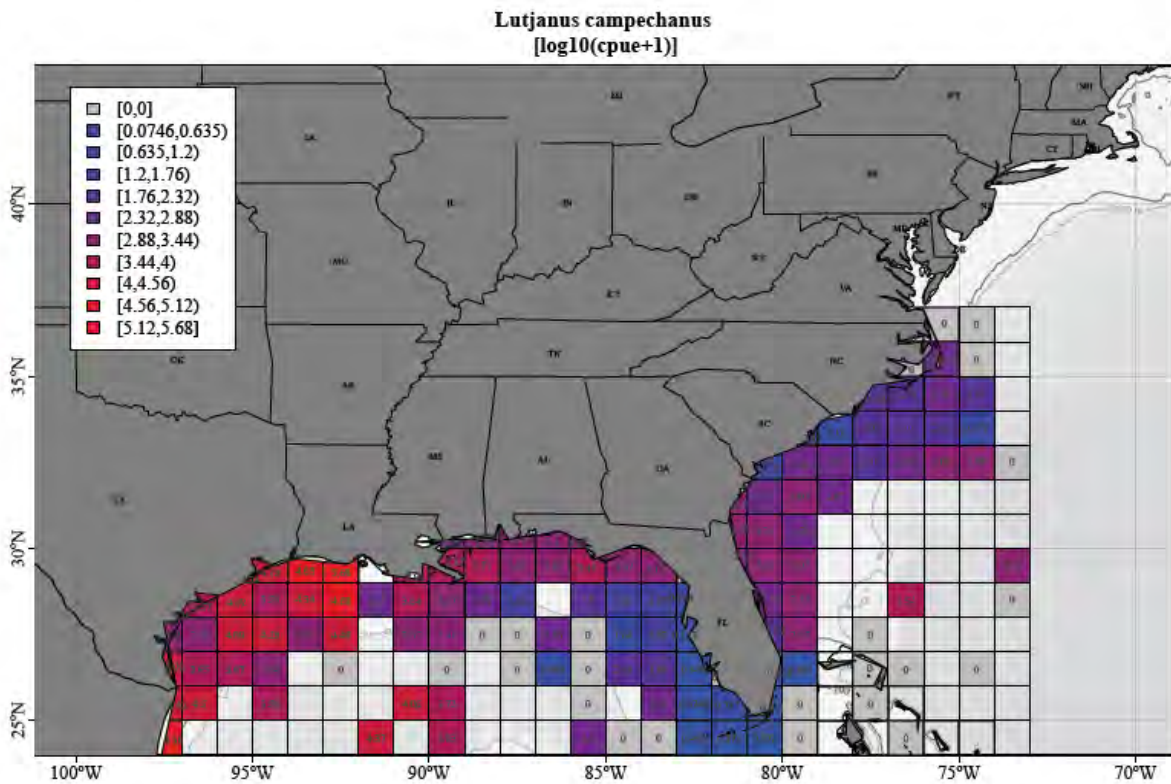
**General Recreational Landings (1981-2019)  
Gulf of Mexico Red Snapper**



**Figure 4.** Distribution of general recreational landings (AB1) for Gulf of Mexico Red Snapper across all years (1981-2019) and in millions of fish (MRIP, TPWD, LA Creel).

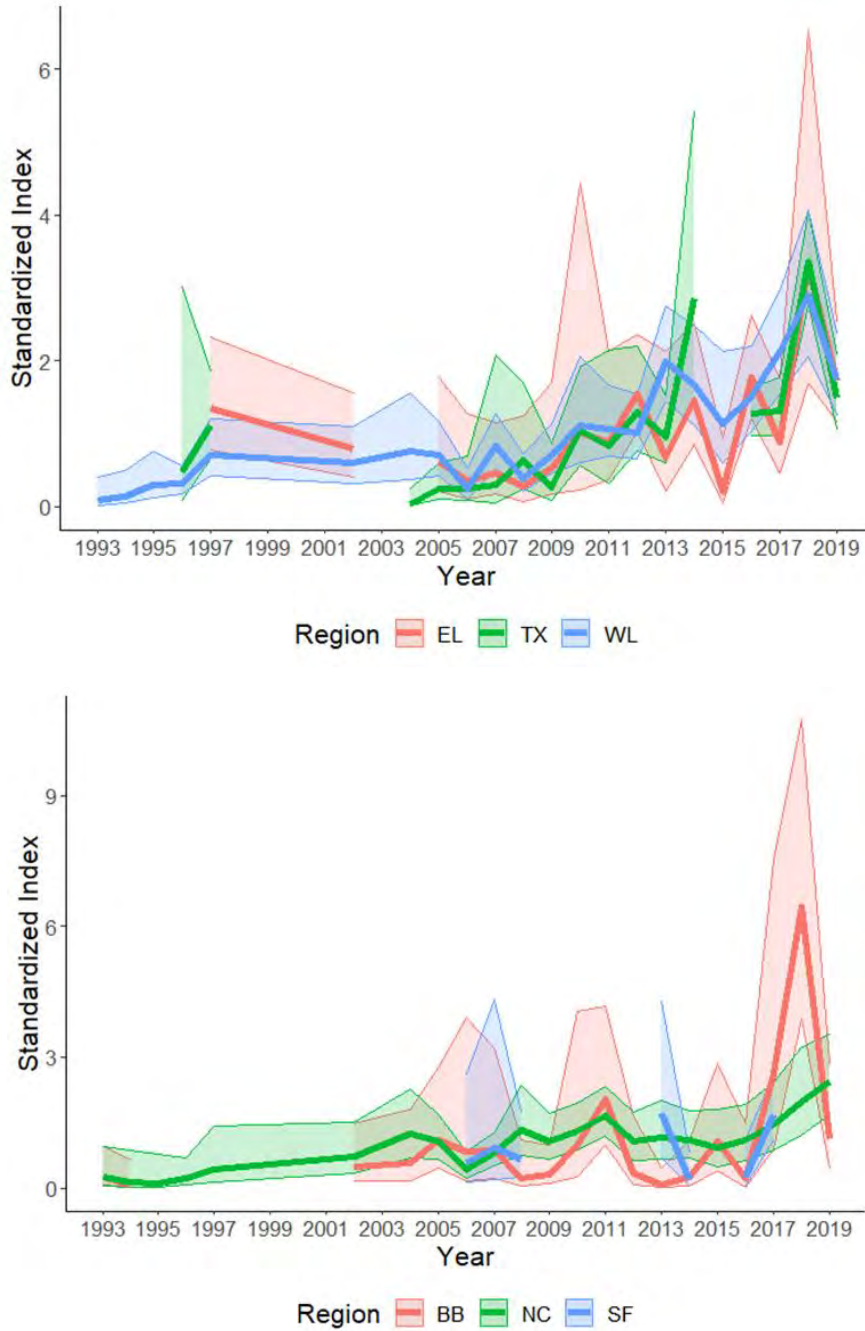


**Figure 5.** Percent of Red Snapper landings (AB1), in numbers of fish, from each state by year between 1981 and 2019 (MRIP, LACreel 2014+, TPWD).

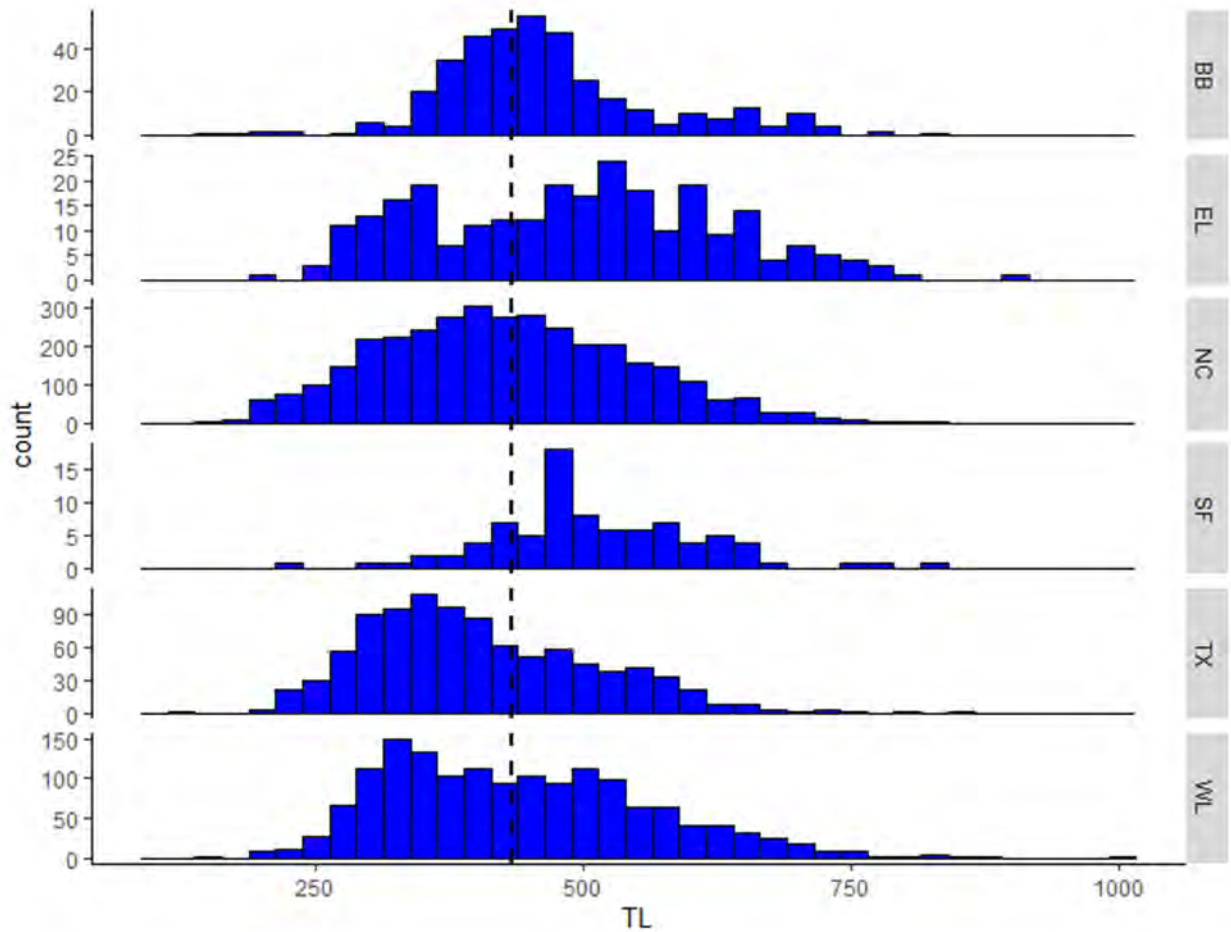


**Figure 6.** Spatial analysis of SRHS catch records, CPUE analysis.



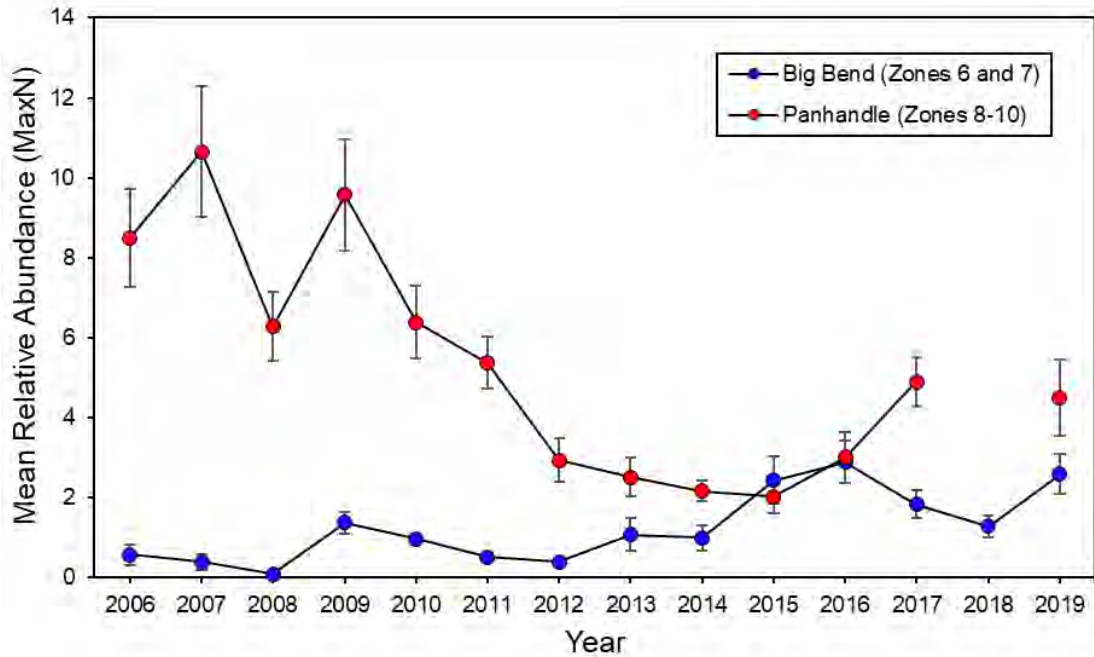


**Figure 7.** Regional differences in average annual Red Snapper observed per station from the MS Labs reef fish survey for the western Gulf (top panel): Texas (TX), East Louisiana (EL), West Louisiana (WL), and for the eastern Gulf (bottom panel): Big Bend (BB), North Central (NC), and South Florida (SF). Regions are shown geographically on Figure 1. From Switzer et al., SEDAR74-SID-03.

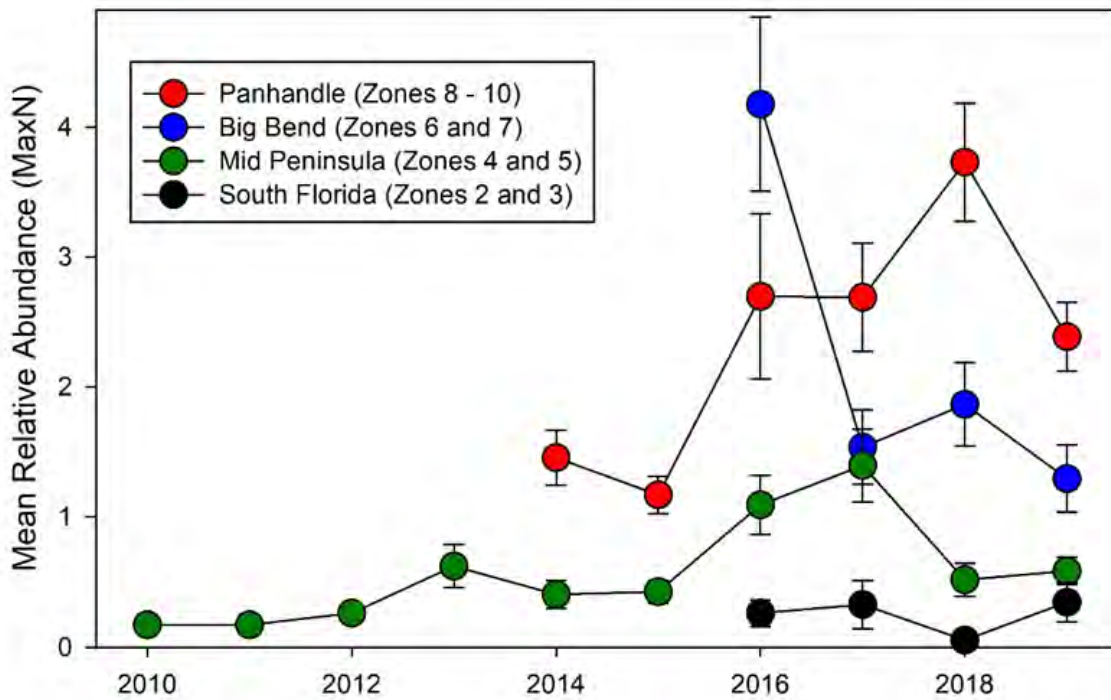


**Figure 8.** Regional differences in size composition of Red Snapper from the MS Labs reef fish survey for the western Gulf: Texas (TX), East Louisiana (EL), West Louisiana (WL), and for the eastern Gulf: Big Bend (BB), North Central (NC), and South Florida (SF). Regions are shown geographically on Figure 1. Dotted line indicates pooled Gulf-wide mean total length ( $a = 0$ ,  $b = 0.95$ , Fish Base length conversion coefficients FL to TL). From Switzer et al., SEDAR74-SID-03.

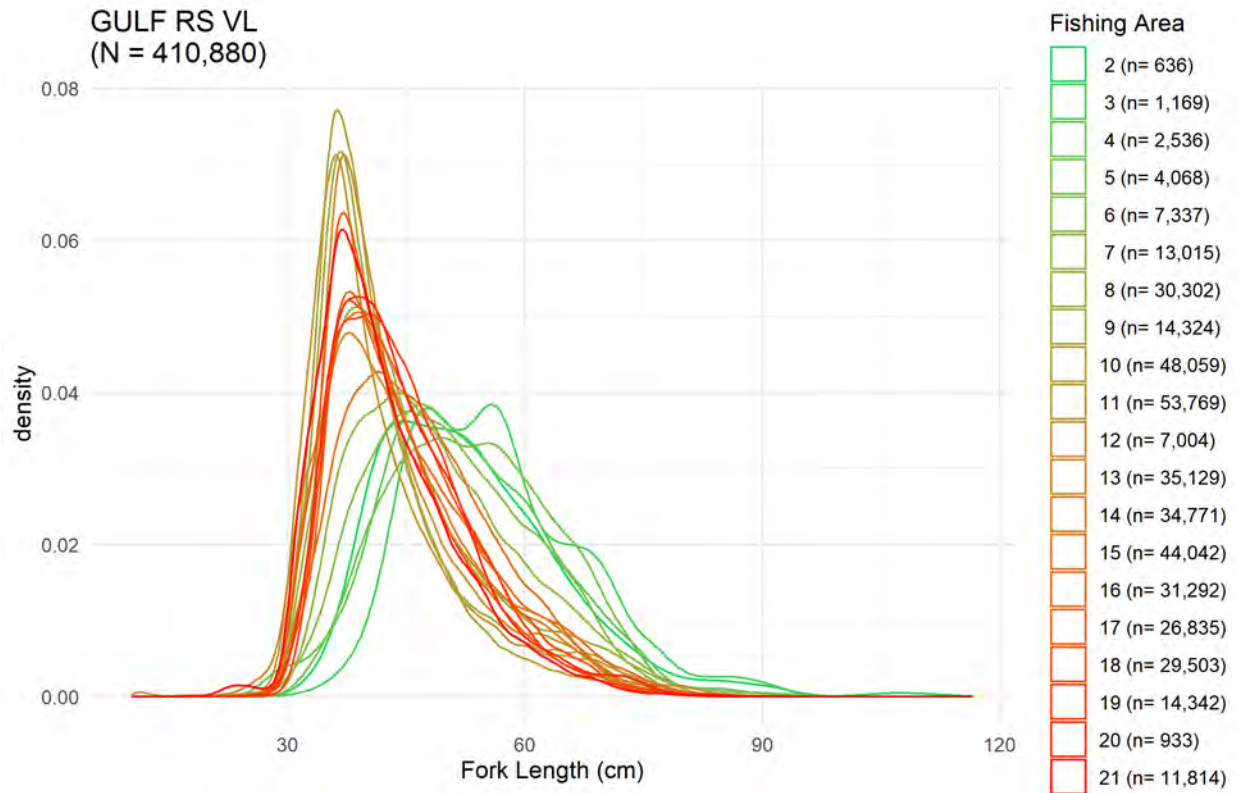




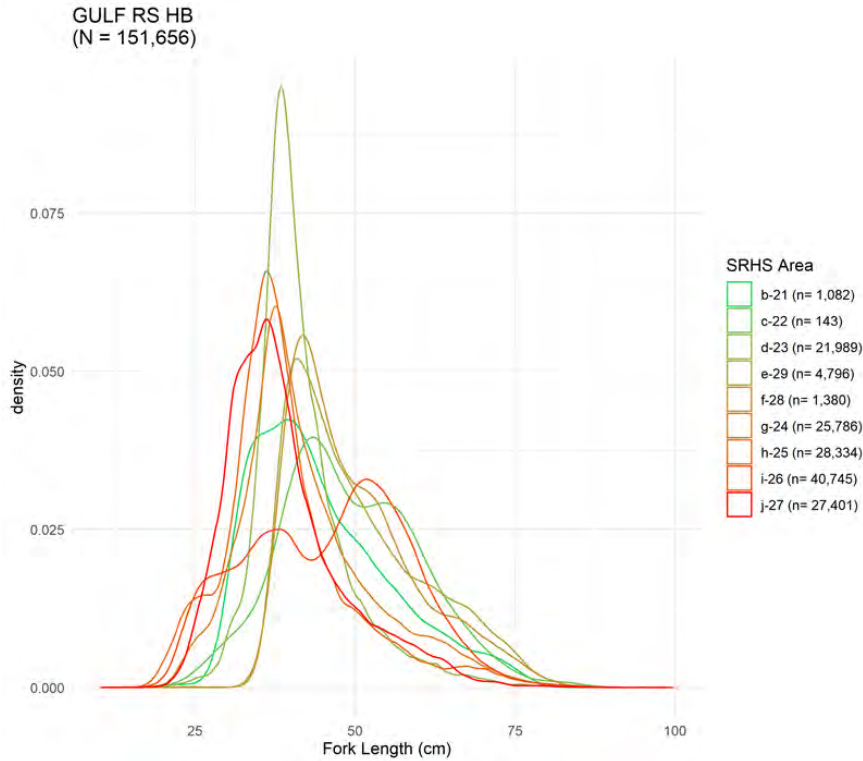
**Figure 9.** Regional differences in average annual Red Snapper observed per station from the Panama City reef fish survey. From Switzer et al., SEDAR74-SID-03.



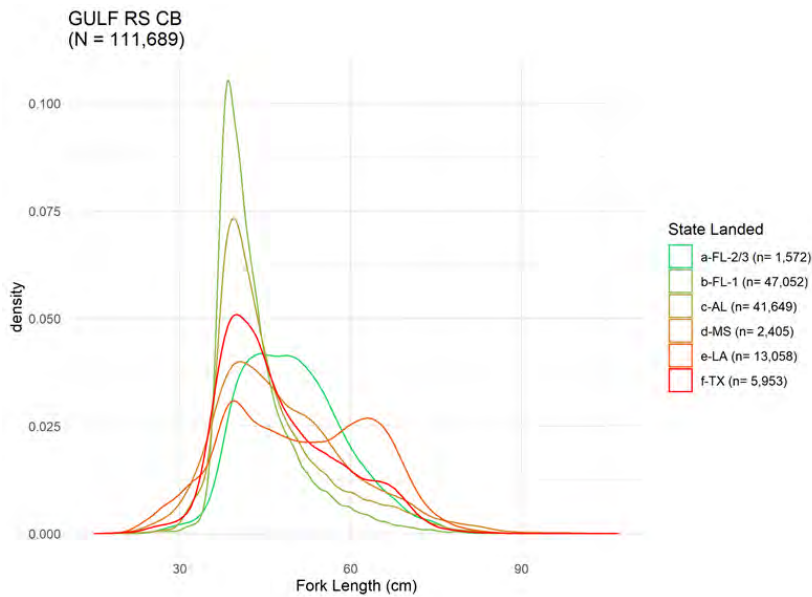
**Figure 10.** Regional differences in average annual Red Snapper observed per station from the FWRI reef fish survey. From Switzer et al., SEDAR74-SID-03.



**Figure 11:** Commercial VL length compositions and sample sizes aggregated across all years (1984-2019) in NMFS statistical grids from the Dry Tortugas (Fishing Area 2) to the Texas/Mexico border (Fishing Area 21) where areas with less than 30 samples were not presented here.



**Figure 12:** Recreational SRHS HB length compositions and sample sizes aggregated across all years (1986-2019) in HB areas from southwestern Florida (SRHS Area 21) to the Texas/Mexico border (SRHS Area 27) where areas with less than 30 samples were not presented here (top panel).



**Figure 13.** Recreational CB length compositions and sample sizes aggregated across all years (1981-2019) in from southwestern Florida to the Texas/Mexico border.

### 3 APPENDICES

#### 3.1 Appendix A: SEDAR 74 Red Snapper Stock ID Option A

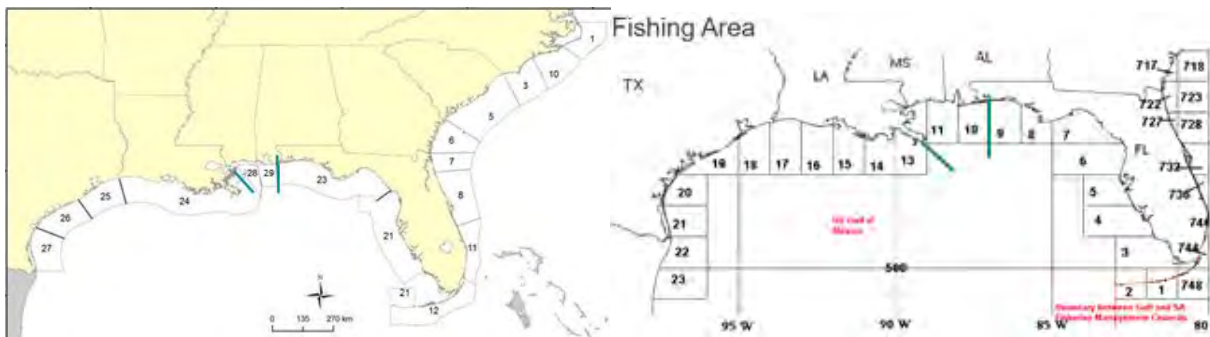
3-area model with boundaries set between stat zones 12/13 and 9/10

#### Boundary Locations per Data Source:

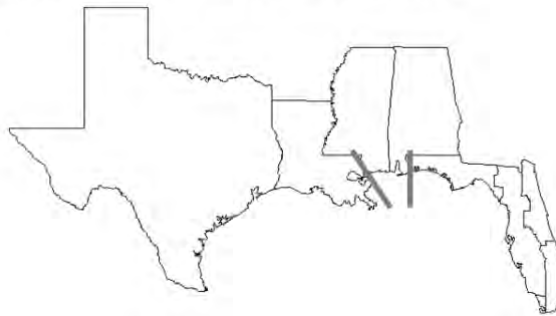
Commercial - East (1-9), Central (10-12), West (13-23)

MRIP - East (FL), Central (AL, MS), West (TX, LA)

SRHS - East (21, 23), Central (28, 29)-Area 29 can only be split from 2013-2020 (split from 23), West (24-27)



Spatial Domains of General Recreational Estimates in the Gulf of Mexico



#### Pros:

- Maintains split at the Mississippi outflow, which is supported by larval connectivity research presented by the movement group (Figure A1).
  - Allows assessment model flexibility to parse out recruitment by area.
  - Aligns with topographic impediments to alongshore flow which influence larval transport: the Mississippi river delta and the DeSoto Canyon (Johnson et. al 2009, Figure A2).
- MS and AL are separated from Florida allowing any differences in trends in abundance (inferred from Fishery-Independent Catch Per Unit Effort (CPUE), Figure A3, SEDAR74-SID-03), and fishery dynamics (selectivity and exploitation rates) between the two areas to be modeled independently.
- Creates areas that align with GRSC abundance estimates facilitating the incorporation of this information into the assessment.

- Maintains the 12/13 boundary **possibly** facilitating sensitivity runs comparing the proposed model to the historic 2-area model.
  - 2-areas in the east could potentially be collapsed into one area without placing an undue burden on the data providers.
- Developing a relatively complex (3-area) model would help to evaluate the performance of simpler (2-area) alternatives (e.g., conditioning an operating model for simulation-evaluation)

### Cons:

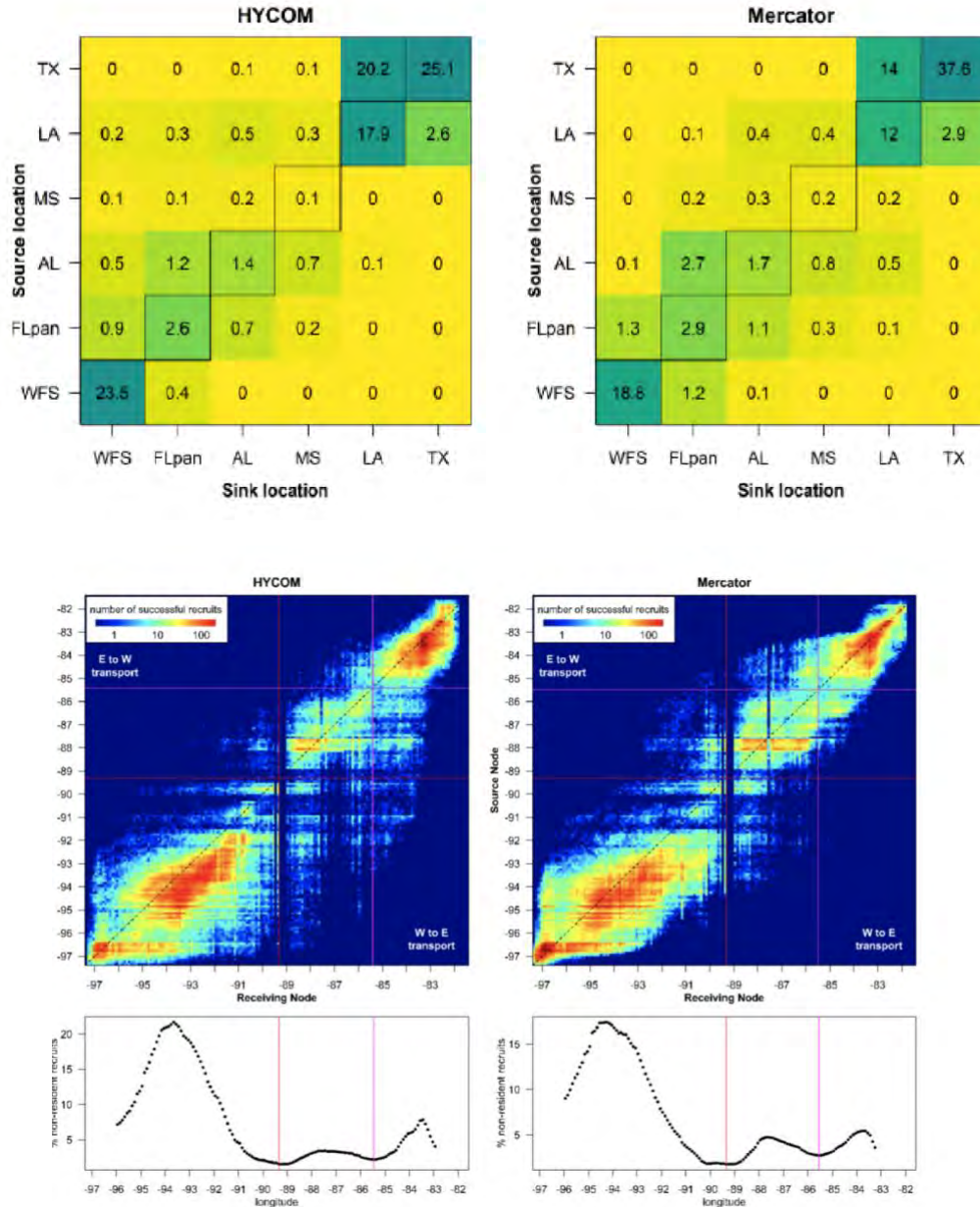
- Creates a small area (MS and AL) which may create problems for some index, composition and/or discard data
  - Likely not all indices will be able to be constructed for all areas.
  - However, not all indices are needed for each area and options for the MS and AL area exist (e.g., DISL survey).
  - Discard calculations for original eastern region can possibly be partitioned to account for differences in landings while using a similar ratio (10-11, 1-9)
- SRHS data did not separate AL and NWFL until 2013. Estimates prior to 2013 covering AL/NWFL would need to be allocated in their entirety to AL or NWFL, or partitioned between the two states by making assumptions about the relative contribution of each state back in time from the available data after 2013.
- Doesn't go far enough East
  - A number of studies pointed to Cape San Blas as the preferred break point; however, restrictions on how landings data have been recorded precluded this as an option.
  - The next available break point is East of San Blas at the boundary between Dixie and Levy county in Florida (Roughly stat zones 6/7). (See Option C for discussion)

Note: Several panelists (mainly members of the GMFMC SSC) expressed concern that the suite of three options on where to divide the GOM Red Snapper stock could not be explored within the assessment. Because there was no strong evidence from the life-history or genetics group to establish a definitive boundary, it seemed prudent to examine how fit to fisheries independent indices differed with different management boundaries.

- This note was added after the final Stock ID webinar on July 22nd.
- Creating and testing multiple assessment models simultaneously to explore all of the presented stock boundaries is currently beyond the scope of the research track.
- Although the Genetics working group did not find substantial evidence to support a definitive boundary, the research and data explored by other working groups did. For instance, the Age, Growth and Reproduction sub group presented research supporting different growth rates and maximum ages on either side of the Mississippi river outflow. In addition, fisheries data such as multiple fishery- independent reef fish surveys, and recreational data support regional differences in fishing dynamics specifically at Cape San Blas.

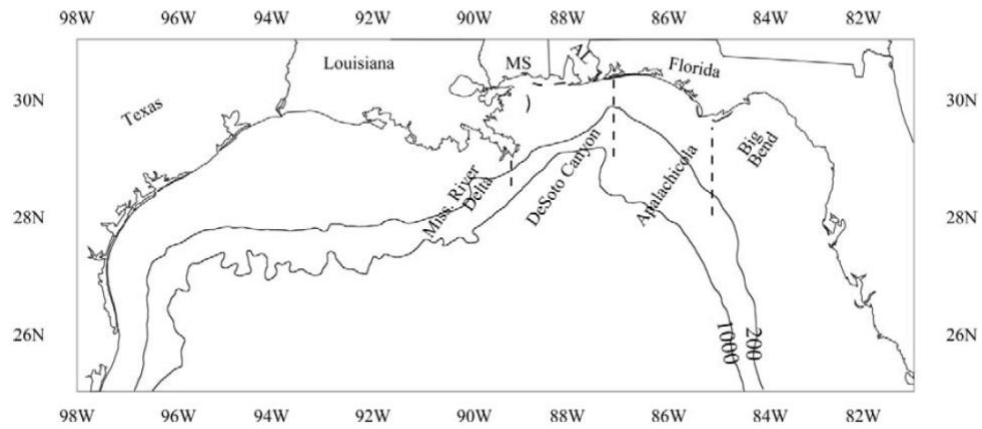




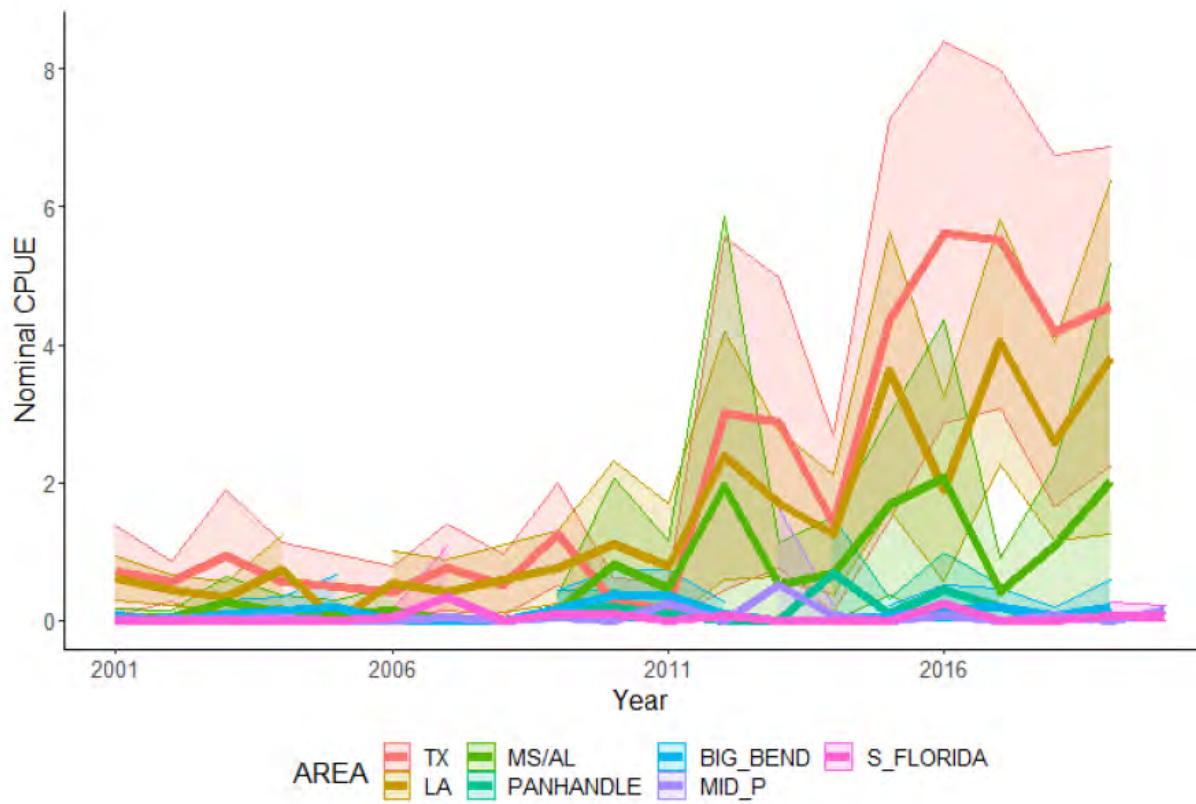


**Figure A1.** Key plots from Karnauskas & Paris (SEDAR74-SID-02). Select Text

- “Larval abundance is twice as great over the Louisiana–Texas shelf as over the Mississippi–Alabama shelf and four times as great over the Mississippi–Alabama shelf as over the West Florida shelf (Hanisko et al. 2007). The results of our study suggest that only a small fraction of the Louisiana–Texas larvae have a chance of being transported eastward across the Mississippi River delta”
- Primary boundary at ~ 89 degrees (Mississippi River) < 2 % larval transfer rate, 98% of successfully settling larvae were retained in regions in which they were spawned - Karnauskas & Paris (SEDAR74-SID-02)



**Figure A2.** Figure 1 from Johnson et al. 2009, “Area in which the transport of larval red snapper was studied. The dashed lines delineate topographic impediments to alongshore flow.”



**Figure A3.** Regional differences in CPUE for red snapper from the NMFS BLL and CSSP BLL surveys for Texas (TX), Louisiana (LA), Mississippi/Alabama (MS/AL), Panhandle, Big Bend, Mid Peninsula (MID\_P), and South Florida (S\_Florida) (Figure 11 in SEDAR74-SID-03).



### 3.2 Appendix B: SEDAR 74 Red Snapper Stock ID Option B

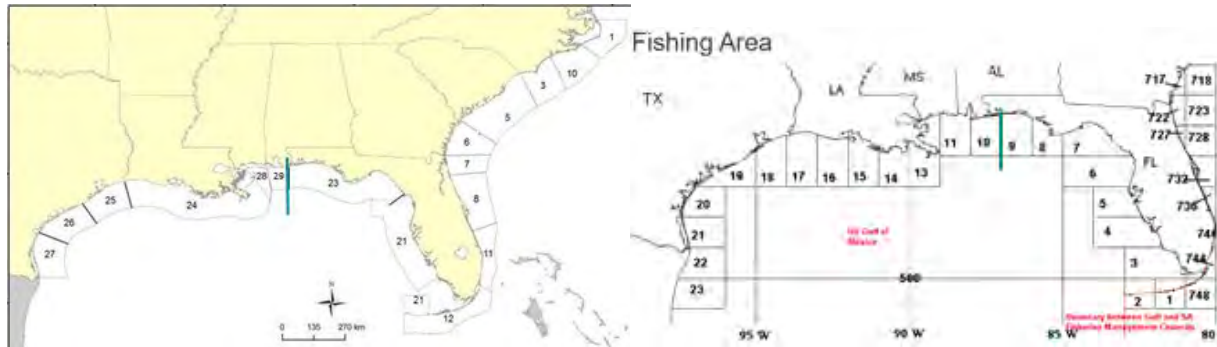
2-area model with boundary set between stat zones 9/10

#### Boundary Locations per Data Source:

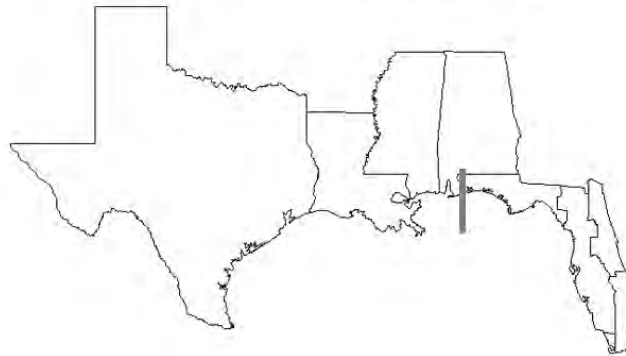
Commercial - East (1-9), West (10-23)

MRIP - East (FL), West (AL, MS, TX, LA)

SRHS - East (21, 23), West (24-29)-Area 29 can only be split from 2013-2020



Spatial Domains of General Recreational Estimates in the Gulf of Mexico



#### Pros:

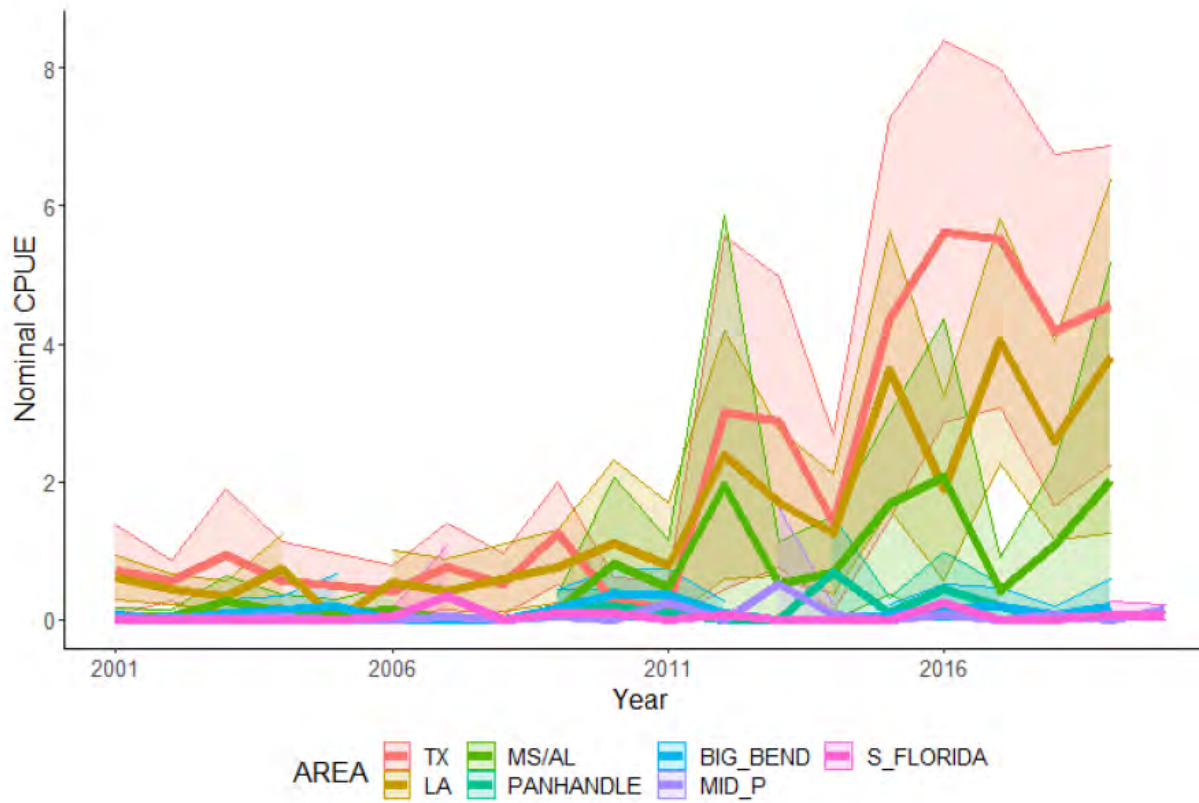
- MS and AL are separated from Florida and pooled with TX and LA, which share similar trends in abundance (inferred from Fishery-Independent CPUE, Figure B1, SEDAR74-SID-03)
- Creates areas that align with GRSC abundance estimates facilitating the incorporation of this information into the assessment.
- Boundary aligns with the bio-geographical break and differences in water clarity and sediment types.
- Removes the split at the Mississippi River which is not supported by genetic research.
  - Given little adult movement across the Mississippi River and high site fidelity, larval transport across the Mississippi River boundary may be responsible for the lack of genetic delineation across the river.

**Cons:**

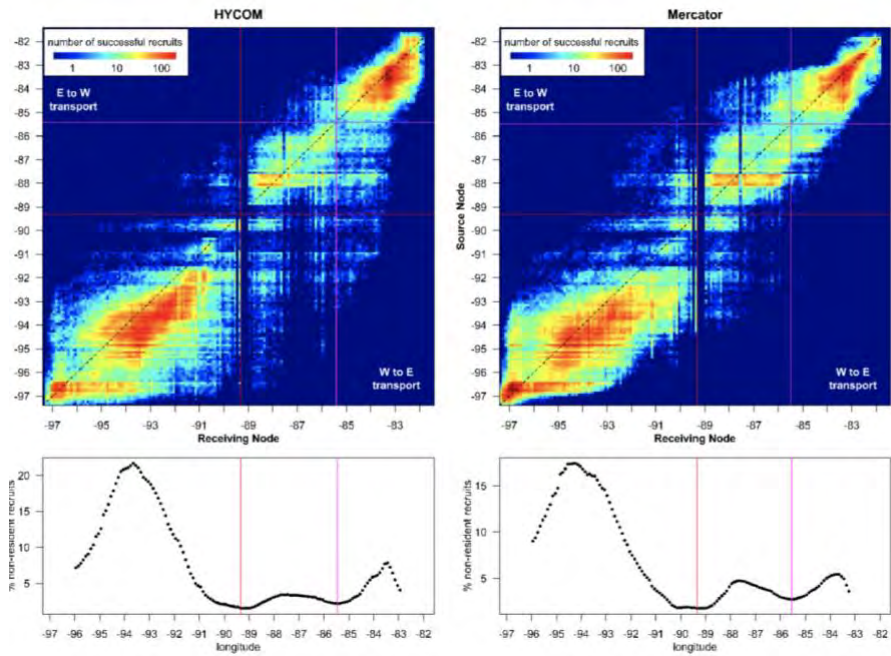
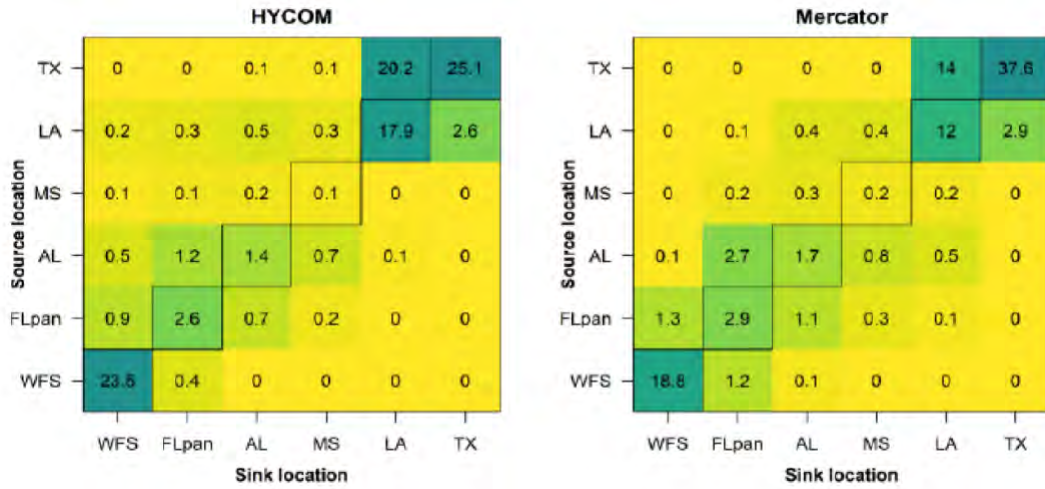
- Removes split at the Mississippi outflow which is not supported by larval connectivity research (Figure B2) presented by the movement group.
  - Forces the analysts to group recruitment in a way that contradicts the connectivity research. The model would also estimate an exploitation rate for all of the Western GOM, blurring the fishing behavior and population dynamics over a very large area.
  - Having the 12/13 boundary does not conflict with the findings of the CPUE group (BLL or MS reef fish survey), so the reason for its removal is unclear.
- Doesn't go far enough East
  - A number of studies pointed to Cape San Blas as the preferred break point; however, restrictions on how landings data have been recorded precluded this as an option.
  - The next available break point is east of San Blas at the boundary between Dixie and Levy county in Florida (Roughly stat zones 6/7). (See Option C for discussion).
- SRHS data did not separate AL and NWFL until 2013. Estimates prior to 2013 covering AL/NWFL would need to be allocated in their entirety to AL or NWFL, or partitioned between the two states by making assumptions about the relative contribution of each state back in time from the available data after 2013
- Removes the 12/13 boundary making it impossible to conduct sensitivity runs comparing the proposed model to the historic 2-area model.

Note: Several panelists (mainly members of the GMFMC SSC) expressed concern that the suite of three options on where to divide the GOM Red Snapper stock could not be explored within the assessment. Because there was no strong evidence from the life-history or genetics group to establish a definitive boundary, it seemed prudent to examine how fit to fisheries independent indices differed with different management boundaries. When advised by SEDAR and SEFSC staff that only one option could be pursued, several of these same panelists favored option b. However, they were deemed to be in the minority and option c was viewed as the consensus.

- See comments for a similar note for Stock ID Option A



**Figure B1.** Regional differences in CPUE for red snapper from the NMFS BLL and CSSP BLL surveys for Texas (TX), Louisiana (LA), Mississippi/Alabama (MS/AL), Panhandle, Big Bend, Mid Peninsula (MID\_P), and South Florida (S\_Florida) (Figure 11 in SEDAR74-SID-03).



**Figure B2.** Key plots from Karnauskas & Paris (SEDAR74-SID-02). Select Text

- “Larval abundance is twice as great over the Louisiana–Texas shelf as over the Mississippi–Alabama shelf and four times as great over the Mississippi–Alabama shelf as over the West Florida shelf (Hanisko et al. 2007). The results of our study suggest that only a small fraction of the Louisiana–Texas larvae have a chance of being transported eastward across the Mississippi River delta”
- Primary boundary at ~ 89 degrees (Mississippi River) < 2 % larval transfer rate, 98% of successfully settling larvae were retained in regions in which they were spawned - Karnauskas & Paris (SEDAR74-SID-02)

### 3.3 Appendix C: SEDAR 74 Red Snapper Stock ID Option C

3-area model with boundary set between stat zones 12/13 and 6/7

#### Boundary Locations per Data Source:

Commercial - East (1-6), Central (7-12) West (13-23)

MRIP - East (FL regions 2&3), Central (FL region 1, AL, MS) West (TX, LA)

SRHS - East (21), Central (23, 28, 29) West (24-27)



Spatial Domains of General Recreational Estimates in the Gulf of Mexico



#### Pros:

- Maintains split at the Mississippi outflow which is supported by larval connectivity research (Figure C1) presented by the movement group.
  - Allows assessment model flexibility to parse out recruitment
- Creates a Central area (MS, AL, FL panhandle) that appears to have similar fishery dynamics (selectivity and exploitation rates).
  - Caveat: FWRI index shows a difference between the panhandle and the big bend, but the BLL (Figure C2) does not (maybe indexing different sizes/ages of fish).
- Maintains the 12/13 boundary **possibly** facilitating sensitivity runs comparing the proposed model to the historic 2-area model.
  - 2-areas in the east could potentially be collapsed into one area without placing an undue burden on the data providers.
- Developing a relatively complex (3-area) model would help to evaluate the performance of simpler (2-area) alternatives (e.g., conditioning an operating model for simulation-

evaluation)

- Both general recreational (Figure C3) and SRHS data (Figure C4) can be provided at this geographic resolution.

### Cons:

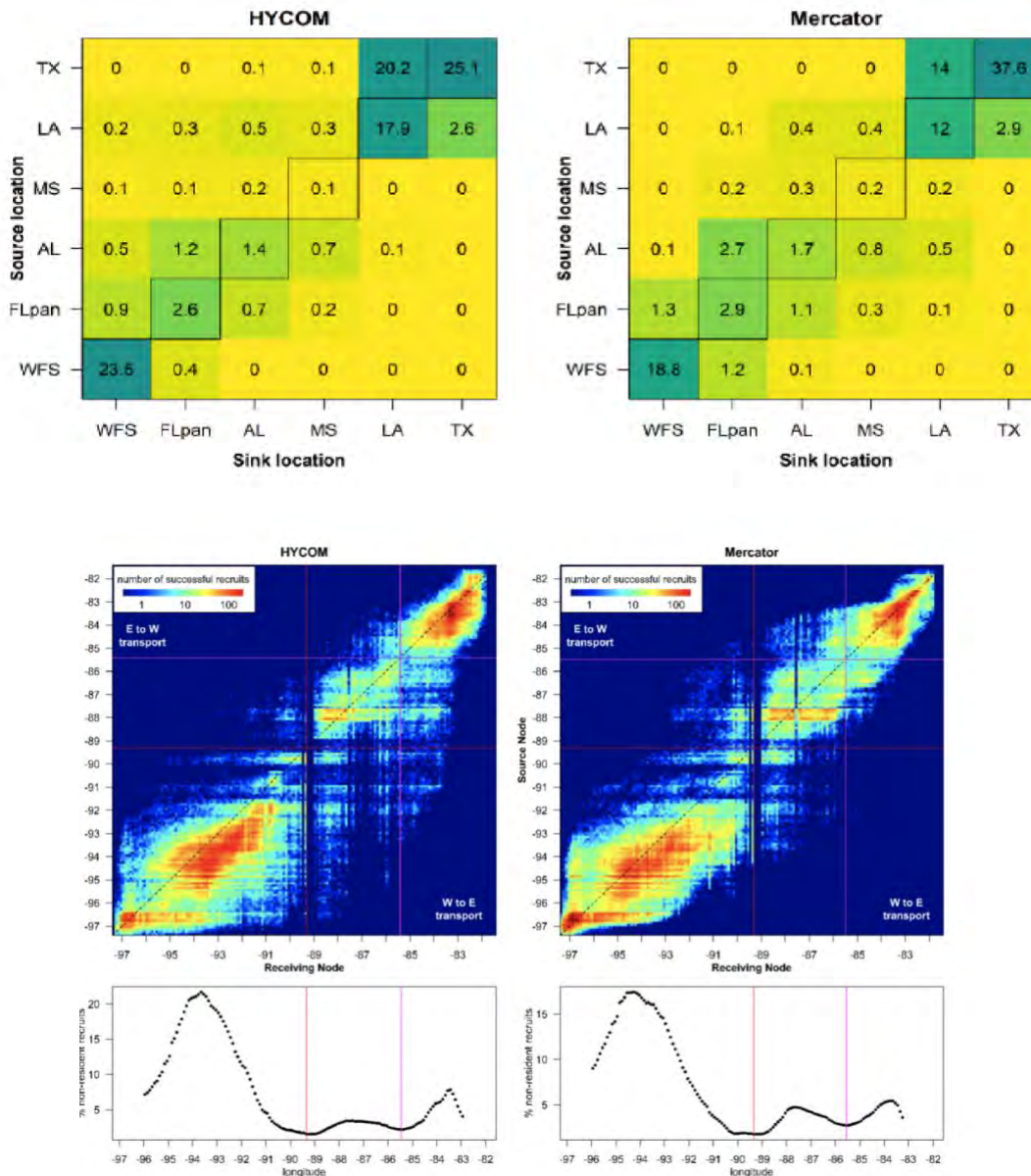
- Creates a data poor area in the East area (essentially the west Florida shelf).
  - Video surveys likely provide a route to an index for this area
  - Ability for compositional data to provide annual comps is of paramount concern
- Discard estimation for smaller east GoM regions potentially complicated by reduced sample size
  - If individual landing/discard ratios for the smaller regions cannot be estimated, an East GoM ratio could be used to expand both regions.
- Goes too far east. Majority of studies indicated a natural breakpoint around Cape San Blas. The 6/7 boundary would include data from ~5 Florida counties (Figure C3) that make up the northern half of the “Big Bend” region.
  - Indications are that landings and discards from these counties may be minimal
- Creates areas that do not align with GRSC abundance estimates complicating but not necessarily prohibiting the incorporation of this data
- This option will be extremely difficult to derive management advice from as the current management scheme relies on state specific quotas and the shared area of MS/AL and only part of Florida could be difficult to derive separable quotas.
  - This bullet was added after the final Stock ID webinar on July 22nd where the final discussion and consensus were made. Therefore, this point was unable to be discussed and clarified for the entire panel.
  - State-specific quotas are currently derived from a single gulfwide ABC produced by the assessment model that is split between the states using percentages established in Amendment 50A to the reef fish management plan. This option will not impact the ability to derive management advice for red snapper unless the Council changes the way in which it distributes quota between the states.
- Separating the effort data (FES) to identify effort in two distinct areas of Florida will be difficult and will require several assumptions to be made in generating the MRIP data to estimate landings, discards and CPUE index.
  - The SEFSC uses the template (domain estimation) programs provided by MRIP to calculate estimates for sub-levels of the survey’s stratification design (e.g., sub-state). These template scripts are available on MRIP’s website (<https://www.fisheries.noaa.gov/recreational-fishing-data/recreational-fishing-data-downloads>) and use standard design-based estimation that incorporates the MRIP design stratification, clustering, and sample weights. Domain estimation has been used to separate Florida (into five sub-regions) for a number of SEDAR assessments, the process of which has been included in SEFSC automation efforts.

Note: Several panelists (mainly members of the GMFMC SSC) expressed concern that the suite of three options on where to divide the GOM Red Snapper stock could not be explored within



the assessment. Because there was no strong evidence from the life-history or genetics group to establish a definitive boundary, it seemed prudent to examine how fit to fisheries independent indices differed with different management boundaries. However, these views were deemed to be in the minority and greater support was found in option c.

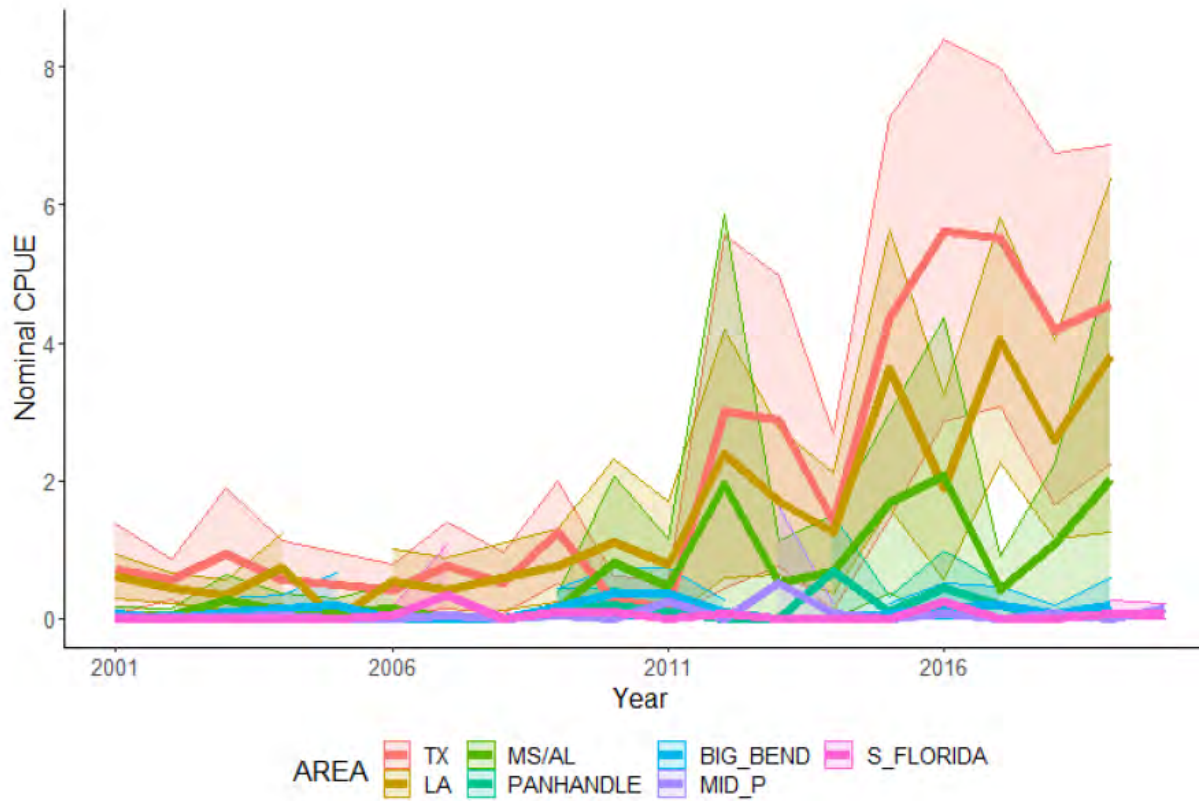
- See comments that address a similar note for Stock ID Option A.



**Figure C1.** Key plots from Karnauskas & Paris (SEDAR74-SID-02). Select Text

- “Larval abundance is twice as great over the Louisiana–Texas shelf as over the Mississippi–Alabama shelf and four times as great over the Mississippi–Alabama shelf as over the West Florida shelf (Hanisko et al. 2007). The results of our study suggest that only a small fraction of the Louisiana–Texas larvae have a chance of being transported eastward across the Mississippi River delta”
- Primary boundary at ~ 89 degrees (Mississippi River) < 2 % larval transfer rate, 98% of successfully settling larvae were retained in regions in which they were spawned - Karnauskas & Paris (SEDAR74-SID-02)

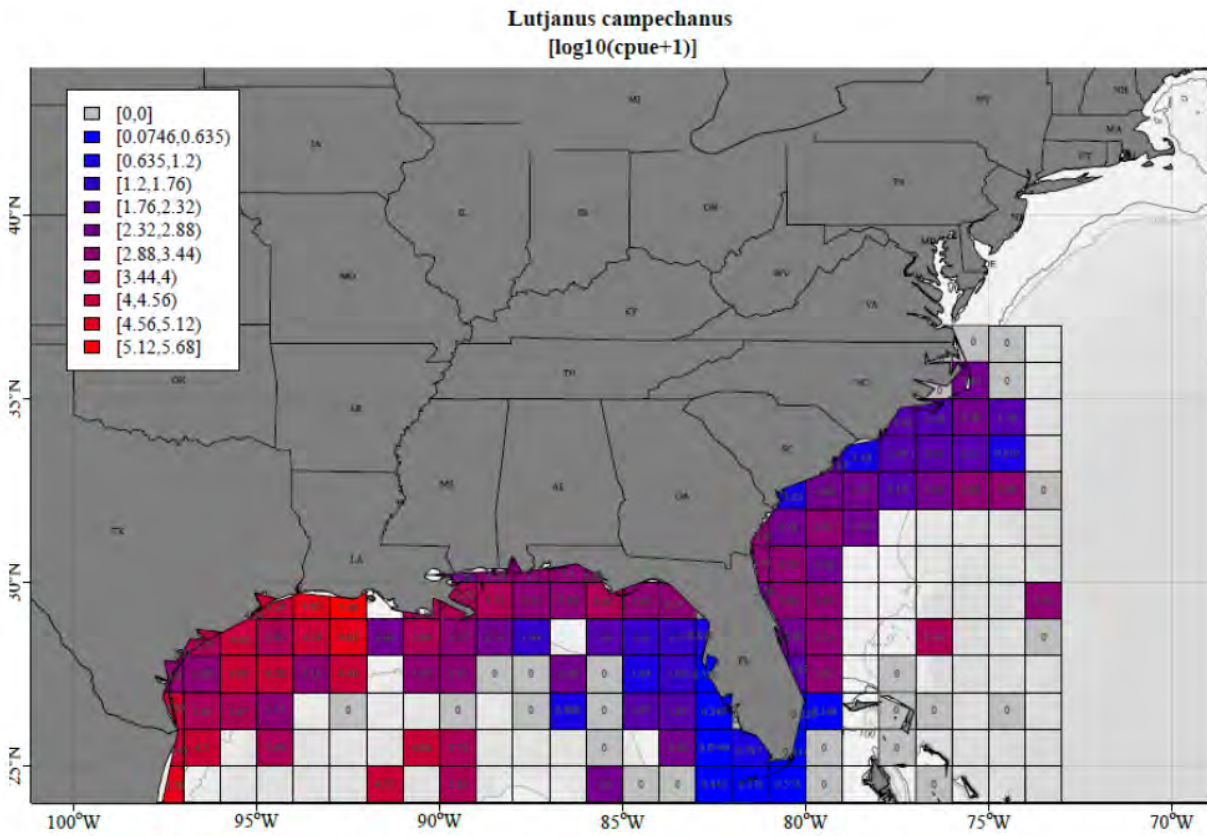




**Figure C2.** Regional differences in CPUE for red snapper from the NMFS BLL and CSSP BLL surveys for Texas (TX), Louisiana (LA), Mississippi/Alabama (MS/AL), Panhandle, Big Bend, Mid Peninsula (MID\_P), and South Florida (S\_Florida) (Figure 11 in SEDAR74-SID-03).



**Figure C3.** General recreational fishing area color coding, representing the different counties that are within the Big Bend region of the West Florida Shelf.



**Figure C4.** Hotspot analysis of red snapper landings for the Southeast Regional Headboat Survey. Boxes delineate potential spatial resolution of landings data.



# SEDAR

## Southeast Data, Assessment, and Review

---

### SEDAR 74

### Gulf of Mexico Red Snapper

### SECTION III: Data Workshop Report

September 2022

SEDAR  
4055 Faber Place Drive, Suite 201  
North Charleston, SC 29405

*This information is distributed solely for the purpose of peer review. It does not represent and should not be construed to represent any agency determination or policy.*

<b>1</b>	<b>INTRODUCTION</b>	<b>6</b>
<b>1.1</b>	<b>WORKSHOP TIME AND PLACE</b>	<b>6</b>
<b>1.2</b>	<b>TERMS OF REFERENCE</b>	<b>6</b>
<b>1.3</b>	<b>LIST OF PARTICIPANTS</b>	<b>8</b>
<b>1.4</b>	<b>LIST OF DATA WORKSHOP WORKING PAPERS &amp; REFERENCE DOCUMENTS</b>	<b>11</b>
<b>2</b>	<b>LIFE HISTORY</b>	<b>28</b>
<b>2.1</b>	<b>OVERVIEW</b>	<b>28</b>
2.1.1	Work Group members and participants in Life History webinars	28
2.1.2	Topics Reviewed by the Life History Group	28
<b>2.2</b>	<b>AGE DATA</b>	<b>29</b>
2.2.1	Research Recommendations	30
<b>2.3</b>	<b>GROWTH</b>	<b>30</b>
2.3.1	Recommendations for SEDAR 74	31
<b>2.4</b>	<b>REPRODUCTION</b>	<b>31</b>
2.4.1	Recommendations for SEDAR 74	34
2.4.2	Research Recommendations	34
<b>2.5</b>	<b>NATURAL MORTALITY</b>	<b>34</b>
2.5.1	Recommendations for SEDAR 74	35
2.5.2	Research Recommendations	36
<b>2.6</b>	<b>EPISODIC EVENTS</b>	<b>36</b>
2.6.1	Research Recommendations	37
<b>2.7</b>	<b>CONVERSIONS</b>	<b>38</b>
<b>2.8</b>	<b>LITERATURE CITED</b>	<b>38</b>
<b>2.9</b>	<b>TABLES</b>	<b>42</b>
<b>2.10</b>	<b>FIGURES</b>	<b>50</b>
<b>3</b>	<b>COMMERCIAL FISHERY STATISTICS</b>	<b>72</b>
<b>3.1</b>	<b>OVERVIEW</b>	<b>72</b>
3.1.1	Commercial Workgroup Participants	73
3.1.2	Issues Discussed at the Data Workshop	73
<b>3.2</b>	<b>REVIEW OF WORKING AND REFERENCE PAPERS</b>	<b>74</b>
<b>3.3</b>	<b>COMMERCIAL LANDINGS</b>	<b>75</b>
3.3.1	Data Source	76
3.3.2	Boundaries	76
3.3.3	Commercial Gears	76

3.3.4	Landings in Numbers	77
<b>3.4</b>	<b>COMMERCIAL DISCARDS AND BYCATCH</b>	<b>77</b>
3.4.1	Discards in Pre-IFQ Years	77
3.4.2	Discards during IFQ Years	79
3.4.3	Discards from the Shrimp Fishery	79
<b>3.5</b>	<b>COMMERCIAL EFFORT</b>	<b>80</b>
3.5.1	Shrimp Trawl Effort	80
<b>3.6</b>	<b>BIOLOGICAL SAMPLING</b>	<b>80</b>
3.6.1	Length Distribution of Commercial Landings	80
3.6.2	Size Frequency Data from Commercial Fisheries Observers	81
3.6.3	Age Distribution	81
<b>3.7</b>	<b>COMMENTS ON ADEQUACY OF DATA FOR ASSESSMENT ANALYSES (KEVIN/STEVE)</b>	<b>81</b>
<b>3.8</b>	<b>RESEARCH RECOMMENDATIONS</b>	<b>82</b>
<b>3.9</b>	<b>LITERATURE CITED</b>	<b>83</b>
<b>3.10</b>	<b>TABLES</b>	<b>84</b>
<b>3.11</b>	<b>FIGURES</b>	<b>103</b>
<b>4</b>	<b>RECREATIONAL FISHERY STATISTICS</b>	<b>115</b>
<b>4.1</b>	<b>OVERVIEW</b>	<b>115</b>
4.1.1	Group Membership	115
4.1.2	Tasks	116
4.1.3	Gulf of Mexico Fishery Management Council Scamp Group Management Boundaries	116
4.1.4	Stock ID Recommendations	117
<b>4.2</b>	<b>REVIEW OF WORKING PAPERS</b>	<b>117</b>
<b>4.3</b>	<b>RECREATIONAL DATA SOURCES</b>	<b>121</b>
4.3.1	Marine Recreational Information Program (MRIP)	121
4.3.2	Louisiana Creel Survey (LA Creel)	123
4.3.3	Texas Parks and Wildlife Department's (TPWD) Marine Sport-Harvest Monitoring Program	124
4.3.4	Southeast Region Headboat Survey (SRHS)	126
4.3.5	Headboat At-Sea Observer Survey	128
<b>4.4</b>	<b>RECREATIONAL LANDINGS</b>	<b>128</b>
4.4.1	MRIP Landings	128
4.4.2	LA Creel Landings	129
4.4.3	TPWD Landings	129
4.4.4	SRHS Headboat Logbook Landings	129
4.4.5	Historic Recreational Landings	130
4.4.6	Total Recreational Landings	132
<b>4.5</b>	<b>RECREATIONAL DISCARDS</b>	<b>132</b>
4.5.1	MRIP Discards	132
4.5.2	LA Creel Discards	132

4.5.3	TPWD Discards	132
4.5.4	Headboat At-Sea Observer Survey Discards	133
4.5.5	SRHS Logbook Discards	133
4.5.6	Total Recreational Discards	134
<b>4.6</b>	<b>BIOLOGICAL SAMPLING</b>	<b>134</b>
4.6.1	Landed Fish	134
4.6.2	Discarded Fish	138
<b>4.7</b>	<b>RECREATIONAL EFFORT</b>	<b>141</b>
4.7.1	MRIP Effort	141
4.7.2	LA Creel Effort	141
4.7.3	TPWD Effort	141
4.7.4	SRHS Effort	141
4.7.5	Total Recreational Fishing Effort	142
<b>4.8</b>	<b>COMMENTS ON ADEQUACY OF DATA FOR ASSESSMENT ANALYSES</b>	<b>142</b>
<b>4.9</b>	<b>Itemized List of Tasks for Completion following Workshop</b>	<b>142</b>
<b>4.10</b>	<b>RESEARCH RECOMMENDATIONS</b>	<b>142</b>
4.10.1	Evaluation and Progress of Research Recommendations from Previous Assessments	143
4.10.2	Research Recommendations for SEDAR 74	144
<b>4.11</b>	<b>LITERATURE CITED</b>	<b>145</b>
<b>4.12</b>	<b>TABLES</b>	<b>149</b>
<b>4.13</b>	<b>FIGURES</b>	<b>174</b>
<b>5</b>	<b>INDICES OF POPULATION ABUNDANCE</b>	<b>189</b>
<b>5.1</b>	<b>OVERVIEW</b>	<b>189</b>
5.1.1	Terms of reference	191
5.1.2	Group membership	191
<b>5.2</b>	<b>REVIEW OF WORKING PAPERS</b>	<b>192</b>
<b>5.3</b>	<b>CONSENSUS RECOMMENDATIONS AND SURVEY EVALUATION</b>	<b>193</b>
<b>5.4</b>	<b>FISHERY-INDEPENDENT INDICES</b>	<b>193</b>
5.4.1	NOAA Fisheries SEFSC Bottom Longline Survey	193
5.4.2	NOAA Fisheries SEFSC Fall Groundfish Survey	194
5.4.3	SEAMAP Summer Groundfish Survey (Old Design)	195
5.4.4	SEAMAP Summer Groundfish Survey (New Design)	197
5.4.5	SEAMAP Fall Groundfish Survey (Old Design)	198
5.4.6	SEAMAP Fall Groundfish Survey (New Design)	199
5.4.7	SEAMAP Reef Fish Video Survey	200
5.4.8	Combined Video Survey	201
5.4.9	SEAMAP Fall Plankton Survey	203
5.4.10	FWRI Artificial Reef Video Survey	204
5.4.11	DISL Bottom Longline	206
5.4.12	NOAA Fisheries SEFSC Bottom Longline Survey / DISL Bottom Longline Survey	206

5.4.13	SEAMAP Vertical Line Survey	207
<b>5.5</b>	<b>FISHERY-DEPENDENT INDICES</b>	<b>208</b>
5.5.1	Recreational (Charterboat and Private)	208
5.5.2	Southeast Region Headboat Survey	209
5.5.3	Commercial Vertical Line (Pre IFQ)	210
5.5.4	Commercial Vertical Line (Post IFQ)	211
<b>5.6</b>	<b>RECRUITMENT INDEX BASED ON THE CONNECTIVITY MODELING SYSTEM</b>	<b>214</b>
<b>5.7</b>	<b>RESEARCH RECOMMENDATIONS</b>	<b>214</b>
<b>5.8</b>	<b>LITERATURE CITED</b>	<b>214</b>
<b>5.9</b>	<b>TABLES</b>	<b>216</b>
<b>5.10</b>	<b>FIGURES</b>	<b>222</b>

## 1 INTRODUCTION

### 1.1 WORKSHOP TIME AND PLACE

The SEDAR 74 Data Workshop was held May 2-6, 2022, in Gulfport, MS. In addition to the in-person workshop, a series for webinars were held before (August 2021, March - April 2022) and after (April-August 2022) the meeting.

### 1.2 TERMS OF REFERENCE

1. Definition of assessment unit stock will be developed through the red snapper Stock ID process and will be added to TORs once process is complete.
2. Review, discuss, and tabulate available life history information for each stock being assessed.
  - Evaluate age, growth, natural mortality, and reproductive characteristics
    - Explore the validity of age data and methodology across ageing facilities
  - Explore differences in growth parameters, spawning fractions, and fecundity data across area
  - Provide appropriate models to describe population and stock specific (if warranted) growth, maturation, and fecundity by age, sex, or length as applicable.
  - Evaluate and discuss the sources of uncertainty and error, and data limitations (such as temporal and spatial coverage) for each data source. Provide estimates or ranges of uncertainty for all life history information.
3. Provide measures of population abundance that are appropriate for stock assessment.
  - Consider all available and relevant fishery-dependent and -independent data sources
  - Document all programs evaluated; address program objectives, methods, coverage, sampling intensity, and other relevant characteristics.
  - Provide maps of fishery and independent survey coverage.
  - Develop fishery and survey CPUE indices by appropriate strata (e.g., age, size, area, and fishery).
  - Provide appropriate measures of uncertainty for the abundance indices to be used in stock assessment models.
  - Document pros and cons of available indices regarding their ability to represent abundance.
  - Categorize the available indices into one of three tiers: Suitable and Recommended, Suitable and Not Recommended, or Not Suitable; *provide each categorization*.
  - For recommended indices, document any known or suspected temporal patterns in catchability not accounted for by standardization.
4. Provide commercial catch statistics for each stock being assessed, including both landings and discards in both pounds and number.
  - Evaluate and discuss the adequacy of available data for accurately characterizing landings and discards by fishery sector or gear.
  - Provide length and age distributions for both landings and discards if feasible.
  - Provide estimates of uncertainty around each set of landings and discard estimates.



5. Provide recreational catch statistics for each stock being assessed, including both landings and discards in both pounds and number.
  - Evaluate and discuss the adequacy of available data for accurately characterizing landings and discards by fishery sector or gear.
    - Specifically explore the transition from MRIP CHTS to FES
    - Specifically explore the Gulf state-specific data collection programs for red snapper for evaluating catch and effort data (i.e. LA Creel, Tails ‘n Scales, Snapper Check, and State Reef Fish Survey)
    - Explore whether the recreational fleet structure can be realigned into individual fleets (private, charter, and headboat) or into a private fleet and a for-hire fleet (charter and headboat combined)
  - Provide length and age distributions for both landings and discards if feasible.
  - Provide estimates of uncertainty around each set of landings and discard estimates.
6. Recommend discard mortality rates.
  - Review available research and published literature.
    - Consider research directed at red snapper as well as similar species from the southeastern United States and other areas.
  - Provide estimates of discard mortality rate by fishery, gear type, depth, and other feasible or appropriate strata.
    - Comment specifically on research detailing the efficacy of descending devices, including their adoption, prevalence of use, and effect on discard mortality
  - Provide estimates of uncertainty around recommended discard mortality rates
  - Document the rationale for recommended rates and uncertainties.
7. Explore the relationship among shrimp bycatch and juvenile red snapper mortality with emphasis on investigation of incorporating potential density-dependent juvenile mortality.
8. Consider the estimates and associated uncertainty derived from the “Great Red Snapper Count” and other independent studies. Provide recommendations for use in the assessment process.
9. Incorporate social and economic information into the stock assessment considerations as practicable.
10. Describe any known evidence regarding ecosystem, climate, species interactions (e.g. predation studies), habitat considerations, species range modifications (expansions or contractions) and/or episodic events (including red tide, upwelling events, and hypoxia) that would reasonably be expected to affect red snapper population dynamics.
11. Develop an updated Connectivity Modeling Simulation recruitment index for recruitment forecasting.

- Explore potential hypotheses to link the ecosystem and climatic events identified to population and fishery parameters.
12. Provide recommendations for future research in areas such as sampling, fishery monitoring, and stock assessment. Include specific guidance on sampling intensity (number of samples including age and length structures) and appropriate strata and coverage.
  13. Prepare a Data Workshop report providing complete documentation of workshop actions and decisions in accordance with project schedule deadlines.

### 1.3 LIST OF PARTICIPANTS

#### ***Assessment Development Team***

LaTreese Denson, Co-Lead Analyst .....	SEFSC/NMFS
Matt Smith, Co-Lead Analyst .....	SEFSC/NMFS
Luiz Barbieri .....	GMFMC SSC/FWRI
David Chagaris.....	GMFMC SSC/UFL
Paul Mickle .....	GMFMC SSC/MS State
Will Patterson.....	GMFMC SSC/UFL
Katie Siegfried .....	SEFSC/NMFS
Jim Tolan .....	GMFMC SSC/TPWD

#### ***Data Process Participants***

David Die (Chair) .....	UM
Jason Adriance .....	SSC/LDWF
Sydney Alhale.....	NOAA/CIMAS
Robert Allman.....	NMFS Panama City
Beverly Barnett .....	NMFS Panama City
Donna Bellais.....	GSMFC
Ken Brennan .....	NMFS Beaufort
Nancy Brown-Peterson .....	USM
Matt Campbell .....	SEFSC Pascagoula
Rob Cheshire.....	NMFS
Francesca Forrestal .....	NMFS Miami
Troy Frady .....	Alabama CFH
Chris Gardner.....	SEFSC/ NMFS
Steve Garner.....	SEFSC/NMFS
Carissa Gervasi .....	UM/CIMAS
Eric Gigli.....	MDMR
Buddy Guindon.....	Katie’s Seafood
David Hanisko .....	NMFS Pascagoula
Erik Lang .....	LDWF
Dominique Lazarre .....	FL FWC
Susan Lowerre-Barbieri .....	FL FWC
John Mareska .....	SSC/AL DCNR
Johnny Marquez.....	MS Wildlife Fed

Vivian Matter .....	SEFSC Miami
Kevin McCarthy.....	NMFS Miami
Trevor Moncrief.....	MS DMR
Heather Moncrief-Cox .....	NMFS/CIMAS
Peter Mudrak.....	LGL Ecological Assoc
Jim Nance.....	SSC
Craig Newton .....	ADCNR/MRD
Matthew Nuttall .....	SEFSC Miami
Will Patterson.....	SSC/UFL
Adam Pollack.....	NMFS Pascagoula
Beverly Sauls .....	FWC-FWRI
Eric Schmidt.....	Ft. Meyers Charter Captain
Steven Scyphers .....	SSC/Northeastern University
Steve Smith .....	UM/CIMAS
Molly Stevens .....	NMFS Miami
Ted Switzer .....	FL FWCC
Kevin Thompson.....	FL FWCC
Julie Vecchio.....	FWC
David Walker .....	Walker Fishing Fleet
Wayne Werner .....	Commercial Fisherman - Alachua
Naeem Willett .....	SEFSC/NMFS
Johnny Williams .....	Williams Party Boats

**Workshop Observers**

Kevin Anson .....	AL DCNR
Scott Bannon.....	ADMR
Michael Drexler .....	Ocean Conservancy
Martha Guyas.....	ASA
Chris Horton.....	Congressional Sportsmen’s Foundation
Ralph Humphrey.....	MS Gulf Fishing Banks
Greg Johnson .....	Auburn Univ
Anna Millender .....	USM
Bob Zales .....	SOFA

**Council Representation**

Susan Boggs.....	GMFMC
Dale Diaz .....	GMFMC
Tom Frazer.....	GMFMC

**Staff**

Julie Neer .....	SEDAR
Judd Curtis .....	SAFMC Staff
Karen Hoak .....	GMFMC Staff
Lisa Hollensead.....	GMFMC Staff
Michael Larkin.....	NMFS/SERO
Ryan Rindone.....	GMFMC Staff

Charlotte Schiaffo ..... GMFMC Staff  
 Carrie Simmons ..... GMFMC Staff

**Other Observers**

Mark Albins ..... DISL  
 Lisa Ailloud ..... SEFSC/NMFS  
 Sarina Atkinson..... NMFS Miami  
 Oscar Ayala..... FWC  
 Larry Beerkircher..... SEFSC/NMFS  
 Kristan Blackhart ..... NOAA  
 Harry Blanchet ..... LADWF  
 Chris Bradshaw ..... FWC  
 Richard Cody ..... NOAA  
 Ellie Corbett ..... FWC  
 Tiffanie Cross..... FWC  
 Matthew Doster..... FWC  
 Kelly Fitzpatrick ..... SEFSC Beaufort  
 John Foster ..... NOAA S&T  
 Benny Gallaway ..... SSC/ LGL Ecological Associates  
 Bob Gill.....  
 Wade Hardy ..... MS DMR  
 Mandy Karnauskas..... NMFS Miami  
 Maxx Lee ..... Mote Marine Lab  
 Alan Lowther ..... NMFS Miami  
 Stephanie Martinez-Rivera ..... NMFS Miami  
 Isabella Masarik ..... NOAA  
 Matt McPherson..... NOAA  
 Hayden Menendez ..... FWC  
 Carole Neidig..... Mote Marine Lab  
 Refik Orhun ..... SEFSC Miami  
 Kate Overly ..... SEFSC/NMFS  
 Kellie Ralston..... ASA  
 Chloe Ramsay ..... FWC  
 Jeff Rester ..... GSMFC  
 Charlie Robertson ..... GSMFC  
 Ashford Rosenberg ..... Shareholders Alliance  
 Jan Mock Schaeffer.....  
 Skyler Sagarese ..... SEFSC/NMFS  
 Liz Scott-Denton..... SEFSC/NMFS  
 Tom Sminkey ..... NOAA  
 Carly Somerset..... GMFMC Staff  
 Ana Vaz ..... NOAA

## 1.4 LIST OF DATA WORKSHOP WORKING PAPERS &amp; REFERENCE DOCUMENTS

Document #	Title	Authors	Date Submitted
<b>Documents Prepared for the Stock ID Process</b>			
SEDAR74-SID-01	Hot Spot Maps of General Recreational Landings for Gulf of Mexico Red Snapper	Matthew A. Nuttall and Vivian M. Matter	25 February 2021
SEDAR74-SID-02	A Lagrangian biophysical modeling framework informs stock structure and spawning-recruitment of red snapper ( <i>Lutjanus campechanus</i> ) in the northern Gulf of Mexico	M. Karnauskas and C. B. Paris	12 March 2021
SEDAR74-SID-03	Insights into the Spatial Dynamics of Red Snapper in the Gulf of Mexico from Gulf-Wide Fishery Independent Surveys	Theodore S. Switzer, Adam G. Pollack, Katherine E. Overly, Christopher Gardner, Kevin A. Thompson, Matt Campbell	15 March 2021
SEDAR74-SID-04	Mississippi Red Snapper Data Summary	Trevor Moncrief	12 March 2021
SEDAR74-SID-05	Spatial analysis of Southeast Regional Headboat Survey Catch Records	Nikolai Klibansky	29 July 2021
SEDAR74-SID-06	Some thoughts on dividing the northern Gulf of Mexico red snapper stock into eastern and western components at the statistical area 9/10 border	Benny J. Gallway and Peter A. Mudrak	30 July 2021
<b>Documents Prepared for the Data Workshop</b>			
SEDAR74-DW-01	General Recreational Survey Data for Red Snapper in the Gulf of Mexico	Nuttall, MA	26 January 2022 Updated: 10 June 2022

SEDAR74-DW-02	Reef Fish Observer Program Metadata	Sarina Atkinson, Judy Gocke, Stephanie Martinez, Elizabeth Scott-Denton	15 December 2021
SEDAR74-DW-03	Coastal Fisheries Logbook Program Metadata	Sarina Atkinson, Michael Judge, Refik Orhun	15 December 2021
SEDAR74-DW-04	LA Creel/MRIP Red Snapper Private Mode Landings and Discards Calibration Procedure	Office of Fisheries Louisiana Department of Wildlife and Fisheries	19 January 2022 Updated: 24 February 2022 4 May 2022
SEDAR74-DW-05	Florida State Reef Fish Survey Metadata	Tiffanie Cross	23 January 2022
SEDAR74-DW-06	A description of Florida's Gulf Coast recreational fishery and release mortality estimates for the central and eastern subregions (Mississippi, Alabama, and Florida) with varying levels of descender use	Julie L. Vecchio, Dominique Lazarre, Beverly Sauls, Marie Head, Trevor Moncrief	8 March 2022
SEDAR74-DW-07	Size and age information for Red Snapper, <i>Lutjanus campechanus</i> , collected in association with fishery-dependent projects along Florida's Gulf of Mexico coast	Julie Vecchio, Jessica Carrol, Dominique Lazarre, Beverly Sauls	3 March 2022
SEDAR74-DW-08	Electronic Monitoring Documentation of Red Snapper ( <i>Lutjanus campechanus</i> ) Catches in the Eastern Gulf of Mexico Commercial Reef Fish Bottom Longline Fishery	Max Lee, Carole Neidig, and Daniel Roberts	18 March 2022
SEDAR74-DW-09	The Reproductive Biology of Red Snapper in Mississippi Waters	Nancy J. Brown-Peterson and Anna K. Millender	12 April 2022 Updated: 31 May 2022 Updated: 14 June 2022

SEDAR74-DW-10	Methodology Description for a Simple Ratio Calibration of Texas Private Boat Red Snapper Annual Landings Estimates	NMFS Office of Science and Technology	15 April 2022
SEDAR74-DW-11	Evaluating Uncertainty in Gulf Red Snapper Estimates: A Preliminary Sensitivity Analysis of Non-Sampling Errors in the Region's Recreational Fishing Surveys	NMFS Office of Science and Technology	15 April 2022
SEDAR74-DW-12	SEFSC Computation of Uncertainty for General Recreational Landings-in-Weight Estimates, with Application to SEDAR 74 Gulf of Mexico Red Snapper	Matthew Nuttall and Kyle Dettloff	15 April 2022
SEDAR74-DW-13	Standardized Catch Rate Indices for Red Snapper ( <i>Lutjanus campechanus</i> ) during 1981-2019 by the U.S. Gulf of Mexico Charterboat and Private Boat Recreational Fishery	Gulf Fisheries Branch, Sustainable Fisheries Division	14 April 2022
SEDAR74-DW-14	Trip Interview Program Metadata	Sarah Beggerly, Molly Stevens, and Heather Baertlein	15 April 2022
SEDAR74-DW-15	Gulf of Mexico Red Snapper ( <i>Lutjanus campechanus</i> ) Commercial and Recreational Landings Length and Age Compositions	Molly H. Stevens	15 April 2022 Updated: 1 July 2022
SEDAR74-DW-16	System dynamics of red snapper populations in the Gulf of Mexico to support ecosystem considerations in the assessment and management process	Carissa Gervasi, Matthew McPherson, and M. Karnauskas	15 April 2022
SEDAR74-DW-17	Standardized Catch Rate Indices for Red Snapper ( <i>Lutjanus campechanus</i> ) during 1993-2006 by the U.S. Gulf of Mexico Vertical Line Fishery	Gulf of Mexico Branch, Sustainable Fisheries Division	15 April 2022
SEDAR74-DW-18	A Summary of Observer Data from the Size Distribution of Red Snapper Discards from Recreational	Dominique Lazarre	15 April 2022

	Fishery Surveys in the Eastern Gulf of Mexico		
SEDAR74-DW-19	CPUE Expansion Estimation for Commercial Discards of Gulf of Mexico Red Snapper	Stephanie Martínez Rivera, Sarina Atkinson, Steven G. Smith, Kevin J. McCarthy	15 April 2022
SEDAR74-DW-20	Gulf of Mexico Red Snapper ( <i>Lutjanus campechanus</i> ) Smooth Age Length Keys	Lisa E. Ailloud	15 April 2022
SEDAR74-DW-21	Using a Censored Regression Modeling Approach to Standardized Catch Per Unit Effort for Red Snapper ( <i>Lutjanus campechanus</i> ) during 1986-2019 from the Southeast Region Headboat Survey in the U.S. Gulf of Mexico	Gulf of Mexico Fisheries Branch	18 April 2022 Updated: 27 May 2022
SEDAR74-DW-22	Commercial Landings of Red Snapper ( <i>Lutjanus campechanus</i> ) from the Gulf of Mexico 1964 - 2020	M. Refik Orhun	19 April 2022
SEDAR74-DW-23	Indices of abundance for Red Snapper ( <i>Lutjanus campechanus</i> ) on natural reefs in the eastern Gulf of Mexico using combined data from three independent video surveys	Kevin A. Thompson, Theodore S. Switzer, Mary C. Christman, Sean F. Keenan, Christopher Gardner, Katherine E. Overly, Matt Campbell	20 April 2022 Updated: 27 April 2022 Updated: 26 May 2022
SEDAR74-DW-24	Develop an updated Connectivity Modeling Simulation recruitment index for recruitment forecasting	Ana Vaz and M. Karnauskas	27 April 2022
SEDAR74-DW-25	Summary of Management Actions for Red Snapper ( <i>Lutjanus campechanus</i> ) from the Gulf of Mexico (1984 - 2022) as Documented within the Management History Database	G. Malone, K. Godwin, S. Atkinson, A. Rios	29 April 2022



SEDAR74-DW-26	Red Snapper Abundance Indices from Bottom Longline Surveys in the Northern Gulf of Mexico	Adam G. Pollack and David S. Hanisko	28 April 2022
SEDAR74-DW-27	Indices of abundance for Red Snapper ( <i>Lutjanus campechanus</i> ) on artificial reefs on the West Florida Shelf from stationary video surveys	Kevin A. Thompson, Theodore S. Switzer, and Sean F. Keenan	29 April 2022
SEDAR74-DW-28	SEAMAP Reef Fish Video Survey: Relative Indices of Abundance of Red Snapper	Matthew D. Campbell, Kevin R. Rademacher, Paul Felts, Joseph Salisbury, Jack Prior	29 April 2022 Updated: 4 May 2022
SEDAR74-DW-29	Gulf State Recreational Catch and Effort Surveys Transition Workshop Summary Report	Gulf MRIP Transition Team	29 April 2022
SEDAR74-DW-30	Red Snapper Abundance Indices from Groundfish Surveys in the Northern Gulf of Mexico	Adam G. Pollack and David S. Hanisko	1 May 2022
SEDAR74-DW-31	Red Snapper ( <i>Lutjanus campechanus</i> ) larval indices of relative abundance from SEAMAP Fall Plankton Surveys, 1986 to 2019	David S. Hanisko, Adam G. Pollack, Denice M. Drass, Pamela J. Bond, Christina Stepongzi, Taniya Wallace, Andrew Millet, Christian M. Jones, Glenn Zapfe and Consuela Cowan	2 May 2022 Updated: 13 July 2022
SEDAR74-DW-32	Co-Producing a Shared Characterization of Depredation in the Gulf of Mexico Reef Fish Fishery: 2022 Workshop Summary Report	Marcus Drymon, Ana Osowski, Amanda Jefferson, Alena Anderson, Danielle McAree, Steven Scyphers, Evan Prasky, Savannah Swinea, Sarah Gibbs, Mandy Karnauskas, Carissa Gervasi	2 May 2022

SEDAR74-DW-33	Fisherman Feedback: Red Snapper - Response Summary	Gulf of Mexico Fishery Council Staff	4 May 2022
SEDAR74-DW-34	Description of age, growth, and natural mortality of Red Snapper from the northern Gulf of Mexico 1980 and 1986-2019	Steven Garner, Robert Allman, Beverly Barnett and Naeem Willett	20 May 2022
SEDAR74-DW-35	Red Snapper General Recreational Open and Closed Season Discard Development	Gulf of Mexico Fisheries Branch	24 June 2022
SEDAR74-DW-36	Best practices for standardized reproductive data and methodology to estimate reproductive parameters for Red Snapper in the Gulf of Mexico	Susan Lowerre-Barbieri, Claudia Friess, Nancy Brown-Peterson, Heather Moncrief-Cox, and Beverly Barnett	30 June 2022 Update: 5 July 2022 Updated: 25 July 2022 Updated: 25 August 25
SEDAR74-DW-37	Estimation of length composition of commercial discards for Gulf of Mexico red snapper	Smith, S.G., S. F. Atkinson, and S. Martinez-Rivera	12 August 2022
SEDAR74-DW-38	Estimation of a Post-IFQ Commercial Vertical Line Abundance Index for Gulf of Mexico Red Snapper Using Reef Fish Observer Data	Smith, S.G.	30 August 2022
SEDAR74-DW-39	SEAMAP Vertical Longline Survey (2012-2021): Indices of Abundance of Gulf of Mexico Red Snapper, <i>Lutjanus campechanus</i>	Mark Albins, John Mareska, Sean Powers	13 July 2022
SEDAR74-DW-40	Modeling fecundity at age in Gulf of Mexico Red Snapper to help evaluate the best measure of reproductive potential	Susan Lowerre-Barbieri and Claudia Friess	18 July 2022
<b>Reference Documents</b>			
SEDAR74-RD01	Data Availability for Red Snapper in Gulf of Mexico and Southeastern U.S. Atlantic Ocean Waters	R. Ryan Rindone, G. Todd Kellison & Stephen A. Bortone	
SEDAR74-RD02	Fine-Scale Movements and Home Ranges of Red Snapper around	Maria N. Piraino & Stephen T. Szedlmayer	

	Artificial Reefs in the Northern Gulf of Mexico	
SEDAR74-RD03	Influence of Age-1 Conspecifics, Sediment Type, Dissolved Oxygen, and the Deepwater Horizon Oil Spill on Recruitment of Age-0 Red Snapper in the Northeast Gulf of Mexico during 2010 and 2011	Stephen T. Szedlmayer & Peter A. Mudrak
SEDAR74-RD04	Depth and Artificial Reef Type Effects on Size and Distribution of Red Snapper in the Northern Gulf of Mexico	J. Jaxion-Harm & S. T. Szedlmayer
SEDAR74-RD05	A cage release method to improve fish tagging studies	Laura Jay Williams*, Jennifer L. Herbig, Stephen T. Szedlmayer
SEDAR74-RD06	Mortality Estimates for Red Snapper Based on Ultrasonic Telemetry in the Northern Gulf of Mexico	Laura Jay Williams-Grove & Stephen T. Szedlmayer
SEDAR74-RD07	Acoustic positioning and movement patterns of red snapper <i>Lutjanus campechanus</i> around artificial reefs in the northern Gulf of Mexico	Laura Jay Williams-Grove & Stephen T. Szedlmayer
SEDAR74-RD08	Depth preferences and three-dimensional movements of red snapper, <i>Lutjanus campechanus</i> , on an artificial reef in the northern Gulf of Mexico	Laura Jay Williams-Grove & Stephen T. Szedlmayer
SEDAR74-RD09	A Comparison of Fish Assemblages According to Artificial Reef Attributes and Seasons in the Northern Gulf of Mexico	J. Jaxion-Harm, S. T. Szedlmayer & P.A. Mudrak
SEDAR74-RD10	A Comparison of Fish and Epibenthic Assemblages on Artificial Reefs with and without Copper-Based, Anti-Fouling Paint	Stephen T. Szedlmayer & Dianna R. Miller
SEDAR74-RD11	Movement patterns of red snapper <i>Lutjanus campechanus</i> based on acoustic telemetry around oil and gas platforms in the northern Gulf of Mexico	Aminda G. Everett, Stephen T. Szedlmayer, Benny J. Gallaway
SEDAR74-RD12	Changes in Shrimping Effort in the Gulf of Mexico and the Impacts to Red Snapper	Benny J. Gallaway, Scott W. Raborn, Laura Picariello, and Nathan F. Putman

SEDAR74-RD13	Using Common Age Units to Communicate the Relative Catch of Red Snapper in Recreational, Commercial, and Shrimp Fisheries in the Gulf of Mexico	Nathan F. Putman & Benny J. Gallaway
SEDAR74-RD14	Distribution and Age Composition of Red Snapper across the Inner Continental Shelf of the North-Central Gulf of Mexico	Sean P. Powers, J. Marcus Drymon, <sup>1</sup> Crystal L. Hightower, Trey Spearman, George S. Bosarge, and Amanda Jefferson
SEDAR74-RD15	Age and growth of red snapper, <i>Lutjanus campechanus</i> , from an artificial reef area off Alabama in the northern Gulf of Mexico	William F. Patterson III, James H. Cowan Jr, Charles A. Wilson, and Robert L. Shipp
SEDAR74-RD16	Red snapper ( <i>Lutjanus campechanus</i> ) demographic structure in the northern Gulf of Mexico based on spatial patterns in growth rates and morphometrics	Andrew J. Fischer, M. Scott Baker Jr., and Charles A. Wilson
SEDAR74-RD17	Temporal Age Progressions and Relative Year-Class Strength of Gulf of Mexico Red Snapper	Robert J. Allman and Gary R. Fitzhugh
SEDAR74-RD18	Age structure of red snapper ( <i>Lutjanus campechanus</i> ) in the Gulf of Mexico by fishing mode and region	Robert J. Allman, Linda A. Lombardi-Carlson, Gary R. Fitzhugh, and William A. Fable
SEDAR74-RD19	Regional differences in the age and growth of red snapper ( <i>Lutjanus campechanus</i> ) in the U.S. Gulf of Mexico	Courtney R. Saari, James H. Cowan Jr., and Kevin M. Boswell
SEDAR74-RD20	A Comparison of Size Structure, Age, and Growth of Red Snapper from Artificial and Natural Habitats in the Western Gulf of Mexico	Matthew K. Streich, Matthew J. Ajemian, Jennifer J. Wetz, Jason A. Williams, J. Brooke Shipley & Gregory W. Stunz
SEDAR74-RD21	A comparison of size and age of red snapper ( <i>Lutjanus campechanus</i> ) with the age of artificial reefs in the northern Gulf of Mexico	Tara S. Syc and Stephen T. Szedlmayer
SEDAR74-RD22	Age and growth of red snapper, <i>Lutjanus campechanus</i> , from the northern Gulf of Mexico off Louisiana	Charles A. Wilson and David L. Nieland

SEDAR74-RD23	Cross-shelf habitat shifts by red snapper ( <i>Lutjanus campechanus</i> ) in the Gulf of Mexico	Michael A. Dance and Jay R. Rooker
SEDAR74-RD24	Habitat-Specific Reproductive Potential of Red Snapper: A Comparison of Artificial and Natural Reefs in the Western Gulf of Mexico	Charles H. Downey, Matthew K. Streich, Rachel A. Brewton, Matthew J. Ajemian, Jennifer J. Wetz, and Gregory W. Stunz
SEDAR74-RD25	A meta-analytical review of the effects of environmental and ecological drivers on the abundance of red snapper ( <i>Lutjanus campechanus</i> ) in the U.S. Gulf of Mexico	Brad E. Erisman, Derek G. Bolser, Alexander Ilich, Kaitlin E. Frasier, Cassandra N. Glaspie, Paula T. Moreno, Andrea Dell’Apa, Kim de Mutsert, Mohammad S. Yassin, Sunil Nepal, Tingting Tang, Alexander E. Sacco
SEDAR74-RD26	Daily movement patterns of red snapper ( <i>Lutjanus campechanus</i> ) on a large artificial reef	Catheline Y.M. Froehlich, Andres Garcia, and Richard J. Kline
SEDAR74-RD27	Movement of Tagged Red Snapper in the Northern Gulf of Mexico	William F. Patterson III, J. Carter Watterson, Robert L. Shipp & James H. Cowan Jr.
SEDAR74-RD28	Did the Deepwater Horizon oil spill affect growth of Red Snapper in the Gulf of Mexico?	Elizabeth S. Herdter, Don P. Chambers, Christopher D. Stallings, and Steven A. Murawski
SEDAR74-RD29	Red Snapper Distribution on Natural Habitats and Artificial Structures in the Northern Gulf of Mexico	Mandy Karnauskas, John F. Walter III, Matthew D. Campbell, Adam G. Pollack, J. Marcus Drymon & Sean Powers
SEDAR74-RD30	Comparison of Reef-Fish Assemblages between Artificial and Geologic Habitats in the Northeastern Gulf of Mexico: Implications for Fishery-Independent Surveys	Sean F. Keenan, Theodore S. Switzer, Kevin A. Thompson, Amanda J. Tyler-Jedlund, and Anthony R. Knapp
SEDAR74-RD31	Estimating Exploitation Rates in the Alabama Red Snapper Fishery Using a High-Reward Tag–Recapture Approach	Dana K. Sackett, Matthew Catalano, Marcus Drymon, Sean Powers, and Mark A. Albins
SEDAR74-RD32	Spatial Heterogeneity, Variable Rewards, Tag Loss, and Tagging Mortality Affect the Performance of Mark–Recapture Designs to Estimate Exploitation: an Example using Red	Dana K. Sackett and Matthew Catalano

	Snapper in the Northern Gulf of Mexico	
SEDAR74-RD33	Modeling the spatial distribution of commercially important reef fishes on the West Florida Shelf	S.E. Saul, J.F. Walter III, D.J. Die, D.F. Naar, B.T. Donahue
SEDAR74-RD34	Descriptions of the U.S. Gulf of Mexico Reef Fish Bottom Longline and Vertical Line Fisheries Based on Observer Data	Elizabeth Scott-Denton, Pat F. Cryer, Judith P. Gocke, Mike R. Harrelson, Donna L. Kinsella, Jeff R. Pulver, Rebecca C. Smith, and Jo Anne Williams
SEDAR74-RD35	The potential for unreported artificial reefs to serve as refuges from fishing mortality for reef fishes	Dustin T. Addis, William F. Patterson III, Michael A. Dance, and G. Walter Ingram Jr.
SEDAR74-RD36	Immature and mature female Red Snapper habitat use in the north-central Gulf of Mexico	A.J. Leontiou, Wei Wu, and Nancy J. Brown-Peterson
SEDAR74-RD37	Importance of Depth and Artificial Structure as Predictors of Female Red Snapper Reproductive Parameters	Nancy J. Brown-Peterson, Robert T. Leaf, and Andrea J. Leontiou
SEDAR74-RD38	Demographic differences in northern Gulf of Mexico red snapper reproductive maturation	Melissa W. Jackson, James, H. Cowan, Jr. and David L. Nieland
SEDAR74-RD39	Estimating the Dependence of Spawning Frequency on Size and Age in Gulf of Mexico Red Snapper	C. E. Porch, G. R. Fitzhugh, E. T. Lang, H. M. Lyon & B. C. Linton
SEDAR74-RD40	Regional Differences in Florida Red Snapper Reproduction	Nancy J. Brown-Peterson, Karen M. Burns, and Robin M. Overstreet
SEDAR74-RD41	Multidecadal meta-analysis of reproductive parameters of female red snapper ( <i>Lutjanus campechanus</i> ) in the northern Gulf of Mexico	Nancy J. Brown-Peterson, Christopher R. Peterson, and Gary R. Fitzhugh
SEDAR74-RD42	A Comparison of Red Snapper Reproductive Potential in the Northwestern Gulf of Mexico: Natural versus Artificial Habitats	Hilary D. Glenn, James H. Cowan Jr. & Joseph E. Powers
SEDAR74-RD43	Temporal and spatial comparisons of the reproductive biology of northern Gulf of Mexico (USA) red snapper ( <i>Lutjanus campechanus</i> ) collected a decade apart	Dannielle H. Kulaw, James H. Cowan Jr., and Melissa W. Jackson

SEDAR74-RD44	Effect of circle hook size on reef fish catch rates, species composition, and selectivity in the northern Gulf of Mexico recreational fishery	William F Patterson III, Clay E Porch, Joseph H Tarnecki, and Andrew J Strelcheck
SEDAR74-RD45	Experimental Assessment of Circle Hook Performance and Selectivity in the Northern Gulf of Mexico Recreational Reef Fish Fishery	Steven B. Garner, William F. Patterson III, Clay E. Porch, and Joseph H Tarnecki
SEDAR74-RD46	Simulating effects of hook-size regulations on recreational harvest efficiency in the northern Gulf of Mexico red snapper fishery	Steven B. Garner, William F. Patterson III, John F. Walter, and Clay E. Porch
SEDAR74-RD47	Effect of reef morphology and depth on fish community and trophic structure in the northcentral Gulf of Mexico	Steven B. Garner, Kevin M. Boswell, Justin P. Lewis, Joseph H. Tarnecki, William F. Patterson III
SEDAR74-RD48	Linear decline in red snapper ( <i>Lutjanus campechanus</i> ) otolith D14C extends the utility of the bomb radiocarbon chronometer for fish age validation in the Northern Gulf of Mexico	Beverly K. Barnett, Laura Thornton, Robert Allman, Jeffrey P. Chanton, and William F. Patterson III
SEDAR74-RD49	Changes in Reef Fish Community Structure Following the Deepwater Horizon Oil Spill	Justin P. Lewis, Joseph H. Tarnecki, Steven B. Garner, David D. Chagaris & William F. Patterson III
SEDAR74-RD50	The Utility of Stable and Radioisotopes in Fish Tissues as Biogeochemical Tracers of Marine Oil Spill Food Web Effects	William F. Patterson III, Jeffery P. Chanton, David J. Hollander, Ethan A. Goddard, Beverly K. Barnett, and Joseph H. Tarnecki
SEDAR74-RD51	A Review of Movement in Gulf of Mexico Red Snapper: Implications for Population Structure	William F. Patterson, III
SEDAR74-RD52	Changes in Red Snapper Diet and Trophic Ecology Following the Deepwater Horizon Oil Spill	Joseph H. Tarnecki and William F. Patterson III
SEDAR74-RD53	Population Structure of Red Snapper in the Northern Gulf of Mexico	John R. Gold and Eric Saillant

SEDAR74-RD54	Mitochondrial DNA variation among red snapper ( <i>Lutjanus campechanus</i> ) from the Gulf of Mexico	Jeff Camper, John R. Gold, and Robert C. Barber
SEDAR74-RD55	A molecular approach to stock identification and recruitment patterns in red snapper ( <i>Lutjanus campechanus</i> )	R.W. Chapman, S.A. Bortone, and C.M. Woodley
SEDAR74-RD56	Stock Structure, connectivity, and effective population size of red snapper ( <i>Lutjanus campechanus</i> ) in the U.S. waters of the Gulf of Mexico	David S. Portnoy
SEDAR74-RD57	Mitochondrial DNA variation among 'red' fishes from the Gulf of Mexico	John R. Gold and Linda R. Richardson
SEDAR74-RD58	Population structure of red snapper ( <i>Lutjanus campechanus</i> ) in U.S. waters of the western Atlantic Ocean and the northeastern Gulf of Mexico	Christopher M. Hollenbeck, David S. Portnoy, Eric Saillant, John R. Gold
SEDAR74-RD59	Population structure and variance effective size of red snapper ( <i>Lutjanus campechanus</i> ) in the northern Gulf of Mexico	Eric Saillant and John R. Gold
SEDAR74-RD60	Population Structure and Variation in Red Snapper ( <i>Lutjanus campechanus</i> ) from the Gulf of Mexico and Atlantic Coast of Florida as Determined from Mitochondrial DNA Control Region Sequence	Amber F. Garber, Michael D. Tringall and Kenneth C. Stuck
SEDAR74-RD61	Genetic homogeneity among geographic samples of snappers and groupers: evidence of continuous gene flow	John R. Gold and Linda R. Richardson
SEDAR74-RD62	Population Structure of Red Snapper from the Gulf of Mexico as Inferred from Analysis of Mitochondrial DNA	J. R. Gold, E Sun, and L. R. Richardson
SEDAR74-RD63	DNA Microsatellite Loci and Genetic Structure of Red Snapper in the Gulf of Mexico	Ed Heist and John R. Gold
SEDAR74-RD64	Genetic impacts of shrimp trawling on red snapper ( <i>Lutjanus campechanus</i> ) in the northern Gulf of Mexico	Eric Saillant, S. Coleen Bradfield, and John R. Gold



SEDAR74-RD65	Genetic variation and spatial autocorrelation among young-of-the-year red snapper ( <i>Lutjanus campechanus</i> ) in the northern Gulf of Mexico	Eric Saillant, S. Coleen Bradfield, and John R. Gold
SEDAR74-RD66	Connections between Campeche Bank and Red Snapper Populations in the Gulf of Mexico via Modeled Larval Transport	Donald R. Johnson, Harriet M. Perry, and Joanne Lyczkowski-Shultz
SEDAR74-RD67	Red snapper, <i>Lutjanus campechanus</i> , larval dispersal in the Gulf of Mexico	Donald R. Johnson and Harriet M. Perry
SEDAR74-RD68	Historical population demography of red snapper ( <i>Lutjanus campechanus</i> ) from the northern Gulf of Mexico based on analysis of sequences of mitochondrial DNA	Christin L. Pruett, Eric Saillant, and John R. Gold
SEDAR74-RD69	Microsatellite Variation Among Red Snapper ( <i>Lutjanus campechanus</i> ) from the Gulf of Mexico	John R. Gold, Elena Pak, and Linda R. Richardson
SEDAR74-RD70	Genomics overrules mitochondrial DNA, siding with morphology on a controversial case of species delimitation	Carmen del R. Pedraza-Marron, Raimundo Silva, Jonathan Deeds, Steven M. Van Belleghem, Alicia Mastretta-Yanes, Omar Dominguez-Domínguez, Rafael A. Rivero-Vega, Loretta Lutackas, Debra Murie, Daryl Parkyn, Lewis H. Bullock, Kristin Foss, Humberto Ortiz-Zuazaga, Juan Narvaez-Barandica, Arturo Acero, Grazielle Gomes, and Ricardo Betancur-R
SEDAR74-RD71	SEDAR52-WP-20: Use of the Connectivity Modeling System to estimate movements of red snapper ( <i>Lutjanus campechanus</i> ) recruits in the northern Gulf of Mexico	M. Karnauskas, J. F. Walter III, and C. B. Paris
SEDAR74-RD72	Fine-scale partitioning of genomic variation among recruits in an exploited fishery: causes and consequences	Jonathan B. Puritz, John R. Gold & David S. Portnoy

SEDAR74-RD73	Historical Population dynamics of red snapper ( <i>Lutjanus campechanus</i> ) in the northern Gulf of Mexico	J. R. Gold and C. P. Burrige
SEDAR74-RD74	Red Snapper Larval Transport in the Northern Gulf of Mexico	Donald R. Johnson, Harriet M. Perry, Joanne Lyczkowski-Shultz & David Hanisko
SEDAR74-RD75	Talking Smack: the archaeology and history of Pensacola's red snapper fishing industry	Nicole Rae Bucchino
SEDAR74-RD76	Distribution, Abundance, and Age Structure of Red Snapper ( <i>Lutjanus campechanus</i> ) Caught on research Longlines in the U.S. Gulf of Mexico	Karen M. Mitchell, Terry Henwood, Gary R. Fitzhugh, and Robert J. Allman
SEDAR74-RD77	SEDAR31-DW15: Spatio-temporal dynamics in red snapper reproduction on the West Florida Shelf, 2008-2011	Susan Lowerre-Barbieri, Laura Crabtree, Theodore S. Switzer, and Robert H. McMichael, Jr.
SEDAR74-RD78	SEDAR52-WP-15: Reproductive data compiled for the Gulf of Mexico Red Snapper, <i>Lutjanus campechanus</i> , SEDAR 52	G.R. Fitzhugh, H.M. Lyon, V.C. Beech, P.M. Colson
SEDAR74-RD79	Trophic ecology of red snapper <i>Lutjanus campechanus</i> on natural and artificial reefs: interactions between annual variability, habitat, and ontogeny	Rachel A. Brewton, Charles H. Downey, Matthew K. Streich, Jennifer J. Wetz, Matthew J. Ajemian, Gregory W. Stunz
SEDAR74-RD80	Comparing reproductive capacity of nearshore and offshore red snapper, <i>Lutjanus campechanus</i> , on artificial reefs in the western Gulf of Mexico	Ricky J. Alexander
SEDAR74-RD81	Reduction of juvenile red snapper bycatch in the U.S. Gulf of Mexico shrimp trawl fishery	Benny J. Gallaway and John G. Cole
SEDAR74-RD82	A Life History Review for Red Snapper in the Gulf of Mexico with an Evaluation of the Importance of Offshore Petroleum Platforms and Other Artificial Reefs	Benny J. Gallaway, Stephen T. Szedlmayer, and William J. Gazey
SEDAR74-RD83	Delineation of Essential Habitat for Juvenile Red Snapper in the Northwestern Gulf of Mexico	Benny J. Gallaway, John G. Cole, Robert Meyer, and Pasquale Roscigno

SEDAR74-RD84	Retrospective Analysis of Midsummer Hypoxic Area and Volume in the Northern Gulf of Mexico, 1985–2011	Daniel R. Obenour, Donald Scavia, Nancy N. Rabalais, R. Eugene Turner, and Anna M. Michalak
SEDAR74-RD85	Space-Time Geostatistical Assessment of Hypoxia in the Northern Gulf of Mexico	V. Rohith Reddy Matli, Shiqi Fang, Joseph Guinness, Nancy. N. Rabalais, J. Kevin Craig, and Daniel R. Obenour
SEDAR74-RD86	Fusion-Based Hypoxia Estimates: Combining Geostatistical and Mechanistic Models of Dissolved Oxygen Variability	Venkata Rohith Reddy Matli, Arnaud Laurent, Katja Fennel, Kevin Craig, Jacob Krause, and Daniel R. Obenour
SEDAR74-RD87	Application of three-dimensional acoustic telemetry to assess the effects of rapid recompression on reef fish discard mortality	Erin Collings Bohaboy, Tristan L. Guttridge, Neil Hammerschlag, Maurits P. M. Van Zinnicq Bergmann, and William F. Patterson III
SEDAR74-RD88	The Great Red Snapper Count: Estimating the Absolute Abundance of Age-2+ Red Snapper ( <i>Lutjanus campechanus</i> ) in the U.S. Gulf of Mexico	Stunz, G. W., W. F. Patterson III, S. P. Powers, J. H. Cowan, Jr., J. R. Rooker, R. A. Ahrens, K. Boswell, L. Carleton, M. Catalano, J. M. Drymon, J. Hoenig, R. Leaf, V. Lecours, S. Murawski, D. Portnoy, E. Saillant, L. S. Stokes., and R. J. D. Wells
SEDAR74-RD89	Spawning origins and ontogenetic movements for demersal fishes: An approach using eye-lens stable isotopes	Julie L. Vecchio, Ernst B. Peebles
SEDAR74-RD90	Discard mortality of red snapper released with descender devices in the U.S. South Atlantic	Brendan J. Rhunde, Nathan M. Bacheler, Kyle W. Shertzer, Paul J. Rudershausen, Beverly Sauls, and Jeffrey A. Buckel
SEDAR74-RD91	Spatial and Temporal Influences of Nearshore Hydrography on Fish Assemblages Associated with Energy Platforms in the Northern Gulf of Mexico	Ryan T. Munnelly, David B. Reeves, Edward J. Chesney, Donald M. Baltz
SEDAR74-RD92	Lessons learned from practical approaches to reconcile mismatches between biological population structure and stock units of marine fish	Lisa A. Kerr, Niels T. Hintzen, Steven X. Cadrin, Lotte Worsøe Clausen, Mark Dickey- Collas, Daniel R. Goethel, Emma M.C.

		Hatfield, Jacob P. Kritzer, and Richard D.M. Nash
SEDAR74-RD93	Defining spatial structure for fishery stock assessment	Steven X. Cadrin
SEDAR74-RD94	Genomic analysis of red snapper, <i>Lutjanus campechanus</i> , population structure in the U.S. Atlantic and Gulf of Mexico	David S. Portnoy, Andrew T. Fields, Jonathan B. Puritz, Christopher M. Hollenbeck, and William F. Patterson, III
SEDAR74-RD95	A simulation framework to assess management trade-offs associated with recreational harvest slots, discard mortality reduction, and bycatch accountability in a multi-sector fishery	Erin C. Bohaboy, Daniel R. Goethel, Shannon L. Cass-Calay, William F. Patterson III
SEDAR74-RD96	Quantifying Delayed Mortality from Barotrauma Impairment in Discarded Red Snapper Using Acoustic Telemetry	Judson M. Curtis, Matthew W. Johnson, Sandra L. Diamond & Gregory W. Stunz
SEDAR74-RD97	Venting and Reef Fish Survival: Perceptions and Participation Rates among Recreational Anglers in the Northern Gulf of Mexico	Steven B. Scyphers, F. Joel Fodrie, Frank J. Hernandez Jr., Sean P. Powers & Robert L. Shipp
SEDAR74-RD98	Testing the efficacy of recompression tools to reduce the discard mortality of reef fishes in the Gulf of Mexico	Oscar E. Ayala
SEDAR74-RD99	Understanding resource-conserving behaviors among fishers: Barotrauma mitigation and the power of subjective norms in Florida's reef fisheries	Chelsey A. Crandall, Taryn M. Garlock, and Kai Lorenzen
SEDAR74-RD100	Recreational angler attitudes and perceptions regarding the use of descending devices in Southeast reef fish fisheries	Judson M. Curtis, Alex K. Tomkins, Andrew J. Loftus, and Gregory W. Stunz
SEDAR74-RD101	Venting or rapid recompression increase survival and improve recovery of red snapper with barotrauma	Karen L. Drumhiller, Matthew W. Johnson, Sandra L. Diamond, Megan M. Reese Robillard and Gregory W. Stunz
SEDAR74-RD102	Descender devices or treat tethers: Does barotrauma mitigation increase opportunities for depredation?	J. Marcus Drymon, Amanda E. Jefferson, Crystal Louallen-Hightower, and Sean P. Powers
SEDAR74-RD103	Sink or swim? Factors affecting immediate discard mortality for the	J.R. Pulver

	Gulf of Mexico commercial reef fishery	
SEDAR74-RD104	Techniques for minimizing discard mortality of GoM of Mexico red snapper and validating survival with acoustic telemetry	Gregory W. Stunz, Judson M. Curtis, and Alex Tompkins
SEDAR74-RD105	Utility of rapid recompression devices in the Gulf of Mexico red snapper fishery	Alex A. Tompkins
SEDAR74-RD106	Gulf of Mexico Fishery Ecosystem Plan	LGL Ecological Research Associates, Inc.
SEDAR74-RD107	Laser ablation–accelerator mass spectrometry reveals complete bomb 14C signal in an otolith with confirmation of 60-year longevity for red snapper ( <i>Lutjanus campechanus</i> )	Allen H. Andrews, Christiane Yeman, Caroline Welte, Bodo Hattendorf, Lukas Wacker and Marcus Christl
SEDAR74-RD108	S68-DW-13: Marine Recreational Information Program Metadata for the Atlantic, Gulf of Mexico, and Caribbean regions	Vivian M. Matter and Matthew A. Nuttall
SEDAR74-RD109	S70-WP-03: Texas Parks and Wildlife Department’s Marine Sport-Harvest Monitoring Program Metadata	Matthew A. Nuttall and Vivian M. Matter
SEDAR74-RD110	Texas Fishing Effort Survey - Final Project Report	NMFS Office of Science and Technology
SEDAR74-RD111	Artificial Attraction: Linking Vessel Monitoring System and Habitat Data to Assess Commercial Exploitation on Artificial Structures in the Gulf of Mexico	Christopher Gardner, Daniel R. Goethel, Mandy Karnauskas, Matthew W. Smith, Larry Perruso and John F. Walter III
SEDAR74-RD112	S68-DW-11: Estimates of Historic Recreational Landings of Scamp and Yellowmouth Grouper in the South Atlantic Using the FHWAR Census Method	Ken Brennan
SEDAR74-RD113	Understanding and Enhancing Angler Satisfaction with Fisheries Management: Insights from the “Great Red Snapper Count”	Steven B. Scyphers, J. Marcus Drymon, Kelsi L. Furman, Elizabeth Conley, Yvette Niwa, Amanda E. Jefferson, and Gregory W. Stunz

SEDAR74-RD114	Assessing reproductive resilience: an example with South Atlantic red snapper <i>Lutjanus campechanus</i>	Susan Lowerre-Barbieri, Laura Crabtree, Theodore Switzer, Sarah Walters Burnsed, Cameron Guenther
---------------	---	---

## 2 LIFE HISTORY

### 2.1 OVERVIEW

The life history group (LHG), comprised of individuals from NOAA Fisheries as well as universities, state agencies, and the private sector, reviewed and discussed available life history data collected since the last Gulf of Mexico red snapper stock assessment (SEDAR 52) was conducted in 2017. Specifically, any new or updated information on age and growth, reproduction, natural mortality, episodic events or meristic conversions was examined to provide recommendations to the SEDAR 74 stock assessment panel. A summary of the data presented, discussed, and recommendations made by the LHG is presented in this document.

#### 2.1.1 *Work Group members and participants in Life History webinars*

Robert Allman-NOAA Fisheries, Panama City, FL (leader)

Beverly Barnett-NOAA Fisheries Panama City, FL

Nancy Brown-Peterson-University of Southern Mississippi

Steven Garner- NOAA Fisheries, Panama City, FL

Carissa Gervasi- University of Miami/NOAA Fisheries, Miami, FL

Erik Lang- Louisiana Department of Wildlife and Fisheries, Baton Rouge, LA

Sue Lowerre-Barbieri- University of Florida, St. Petersburg, FL

Heather Moncrief-Cox- NOAA Fisheries, Panama City, FL (rapporteur)

Peter Mudrak- LGL Ecological Research Associates, Inc.

Molly Stevens- NOAA Fisheries, Miami, FL

Naeem Willet- NOAA Fisheries, Panama City, FL (rapporteur)

#### 2.1.2 *Topics Reviewed by the Life History Group*

1. Age
2. Growth
3. Reproduction
4. Natural Mortality

## 5. Episodic events

## 6. Conversions

## 2.2 AGE DATA

Quality age data (i.e., high accuracy and precision) are crucial for informing a variety of parameter estimates in stock assessments, such as size- and egg production-at-age, age-specific natural mortality, and tracking cohorts over time. Several studies have been conducted using sagittal otoliths to age red snapper and provide basic information on growth and annulus formation (Futch and Bruger, 1976; Bortone and Hollingsworth, 1980; Nelson and Manooch, 1982; Wilson and Nieland, 2001; Manooch and Potts, 1997; Patterson et al., 2001; Fischer et al. 2004). Additionally, reader interpretation of red snapper otolith thin sections and the repeatability of age estimates (i.e., precision) have been examined (Allman et al., 2005). Recently, the maximum age of Gulf of Mexico red snapper was validated to at least 45 years using analysis of bomb radiocarbon  $\Delta^{14}\text{C}$  from otolith cores (Barnett et al. 2018; Andrews et al. 2019). Observed age estimates for otoliths with bomb radiocarbon-derived age estimates were as high as 53 years, but these could not be validated due to the birth year occurring prior to nuclear testing (Barnett et al. 2018). However, the methods for estimating ages from the otolith thin sections used in bomb radiocarbon validation studies were the same as those used to generate red snapper production age estimates.

A total of 239,409 ages were assigned to red snapper sampled from the GOM in 1980 and from 1986 to 2019, which consisted of 96,571 samples from the West, 118,228 from the Central, and 24,610 from the East subregion (Figure 1). The number of age samples by year, subregion, and fishery (commercial, recreational, fishery independent, or unknown) are listed in Table 1. In earlier years, the majority of ages were from the western GOM. In recent years, a greater proportion of age samples were collected east of the Mississippi River (Central and East subregions) with NMFS and GulfFIN sampling programs providing most samples (Fig. 2). The number of age samples by year, subregion, and gear type (vertical line [handline or hook-and-line], longline [bottom longline or vertical longline], other [trap, trawl, spear], or unknown) are listed in Table 2. The size distribution of red snapper lengths was different among all subregions with right-skewed distributions for the West and Central and an approximately normal distribution for the East (Fig. 3). Mean ( $\pm$ SE) fork length (cm) of red snapper was highest ( $52.7 \pm 0.07$ ) in the East and lowest ( $46.43 \pm 0.03$ ) in the Central subregion. Mean age (yr, fractional) of red snapper differed by only 0.6 yr among subregions with the West subregion having the highest ( $4.95 \pm 0.01$ ) and the Central having the lowest ( $4.30 \pm 0.01$ ) mean age. The distribution of ages among subregions was generally similar, but the West subregion had both more and a higher proportion of older fish (Fig. 4). The oldest observed ages (calendar) were 57, 49, and 45 yrs for the West, Central, and East subregions, respectively (Fig. 4). Age distributions by subregion and year are shown in Figures 5-7. All three regions show evidence of a strong 2014 year-class. Red snapper ages from recreational and fishery independent samples were oldest in

the West, while fish from commercial samples in the West and East were similarly older than the Central subregion (Fig. 8). Frequency distributions of red snapper age samples by year from the commercial and recreational sectors are shown in Figures 9 and 10.

### 2.2.1 Research Recommendations

Resources are needed for personnel and database infrastructure to manage large, multi-decade life history datasets that are beginning to exceed the capabilities of standard computers.

Create a data repository with an upload interface for data providers to submit data directly into the SEDAR template. Build in standardized QA/QC methods for all data providers so that erroneous data points and outliers are identified and corrected prior to data workshops.

Resume annual ageing workshops with gulf state agencies and other age data contributors to maintain high-quality age data given standard turnover rates among primary agers.

Expand routine biological sampling, particularly in the eastern GOM subregion, where sample sizes are much lower compared to other subregions.

The current subsampling protocol for red snapper is based on 5-year average landings by grid and is laborious and time consuming. Evaluate the current otolith subsampling protocol and provide alternatives to streamline the process.

Evaluate the sampling design for observer programs.

Investigate new technologies for estimating life history parameters (e.g. FT-NIRS, epigenetics) to increase production ageing efficiency and precision of age estimates.

Increase sampling of sublegal fish through fishery independent surveys and the shrimp observer program to better estimate maturity and fecundity of smaller individuals, as well as samples through tournament intercepts to better estimate batch fecundity of larger/older females.

## 2.3 GROWTH

Visual inspection of the size-modified von Bertalanffy growth functions (VBGF) plotted against size-at-age data indicated that models fit to inverse weighted data (i.e.,  $1/\text{age-specific } n$ ) provided better fits to the older age classes (15+ yrs), which had disproportionately fewer samples than younger age classes (Fig. 11). Population growth model parameters indicated that the parameter for mean size-at-maximum length ( $L_{\infty}$ ) had decreased by 3.54 cm since the data were last assessed in SEDAR 52 (Garner et al. 2022, SEDAR74-DW-34). Modeling the size-modified VBGF variance component as a linear function of size-at-age produced the best fit to the inverse weighted size-at-age data based on Akaike's information criterion corrected for sample size (AICc; Table 3). Different variance forms were best fit to each of the three subregions (Table 4) however, subregion-specific growth models with variance modeled as a linear function of size-at-age had a cumulative AICc value of only 5.5 points higher than the best fit models for the West and East subregions, respectively. Stock Synthesis requires a single functional form for



growth, thus, parameters estimated with VBGF models with variance as a linear function of size-at-age were used for the final analyses.

Growth parameters estimated for  $L_{\infty}$  were lowest in the West compared to the other two regions, which had similar values; parameter estimates for  $k$  were highest in the East compared to the other two regions, which had similar values (Fig. 12). Mean size-at-age increased at similar rates among regions from 0-5 yrs, then diverged with fish from the East increasing fastest towards the mean maximum length (Fig. 13). Mean size-at-age in the Central and West subregions began to diverge at approximately age-10, where fish from the Central began to approach the same mean maximum size as fish from the East; fish from the West remained smaller-at-age at older ages.

The VBGF parameters also were estimated by time stanza (1991-2008, 2009-2015 and 2016-2019 based on yearly trends in biomass levels that roughly correspond to depletion, rebuilding, and asymptotic recovery of the stock). Age samples from the Central and East were combined due to low sample sizes collected during the most recent time-period. This analysis did not indicate any meaningful divergence in size-at-age among time stanzas within the two subregions (Fig. 14); fish from the most recent time stanza (2016-2019) did have smaller size-at-age for some age classes, but confidence intervals overlapped in most cases.

### 2.3.1 Recommendations for SEDAR 74

Use inverse weighted age data for fitting growth curves.

Estimate growth separately for each subregion with data from all years combined.

## 2.4 REPRODUCTION

Reproductive potential plays an important role in stock assessments and biological reference points and is commonly measured as either spawning stock biomass (SSB) or total egg production (TEP). Both measures need an estimate of the sex ratio. Estimates of size- and age-at-maturity are needed for SSB, whereas for TEP there is also the need to estimate annual fecundity-at-age.

Both Red Snapper stock assessments and recent publications have reported decreased reproductive productivity in the region west of the Mississippi River and throughout the Gulf of Mexico (GOM or Gulf) as the stock recovers. Fish in the eastern Gulf (east of the Mississippi River) are reported to be younger and to mature earlier than those from the western Gulf (SEDAR 2005; SEDAR 2013; SEDAR 2018). More recently, decreased reproductive output at age has been reported, although with varying intensity depending on region (SEDAR 52). New publications and data since SEDAR 52 support these patterns and include: Brown-Peterson et al., (2019, 2021), Leontiou et al., (2021a,b), Froelich et al., (2021), Millender and Brown-Peterson, (2022), and Brown-Peterson and Millender (2022). Brown-Peterson et al. (2019) conducted a meta-analysis on Red Snapper reproductive data collected from 1991-2017 throughout the GOM

and report decreased spawning frequency and batch fecundity in recent years, especially in the western Gulf. Red Snapper spawning activity also has been reported to increase with depth (Glenn et al., 2017; Brown-Peterson et al., 2021; Froehlich et al., 2021; Millender and Brown-Peterson, 2022). In contrast, structure type does not appear to greatly influence Red Snapper reproductive parameters in either the eastern (Brown-Peterson et al., 2021) or western (Downey et al., 2018) GOM.

For SEDAR 74, a total of 169,178 records had a sex assigned as male or female based on macroscopic or histological evaluation. Of these, 11,527 females had a reproductive phase based on histological assessment and 10,527 of these also had length and a calendar age. Samples were not evenly distributed by year or subregion, with Central and West each having more than 5,000 samples and East only having 615 (Figure 15). They were also not evenly distributed by age with 98% being age 15 or younger (Figure 16). Sample size greatly decreased for batch fecundity estimates (1,231 and 1,136 with an age), and 94% of these were for young fish (age 10 y or younger, Figure 17). Immature females were relatively rare (n=344, 341 with ages). The sex ratio, similar to past assessments, was approximately 1:1, with 52% female and 48% male.

Reproductive traits were estimated over three time periods and two regions (Lowerre-Barbieri et al., 2022; Lowerre-Barbieri and Friess, 2022). Given the changes in SSB and SPR over time (SEDAR 52) and potential for reproductive traits to vary with stock status, three stock status time periods were assigned: (1) from 1991-2008, when the stock was severely overfished; (2) from 2009-2016, when the stock was rapidly recovering; and (3) from 2017-2019 as stock abundance began to stabilize. Spatially, reproductive traits were estimated for two regions, West and East of the Mississippi River, due to insufficient data to separate the East into an East and Central region. Standardized terms and methods to estimate and describe reproductive dynamics were adopted (Lowerre-Barbieri et al., 2022), building on Brown-Peterson et al. (2011), Lowerre-Barbieri et al. (2011), and a draft best practices reproductive data template developed to help standardize reproductive data for stock assessments in the Southeast.

Red Snapper have an extended and asynchronous spawning season, with spawning observed as early as January 16<sup>th</sup> and as late as December 18<sup>th</sup>, a duration of 337 d. A core spawning season of 218 d from March 17<sup>th</sup> to October 21<sup>st</sup> was estimated using the 50% spawning method (Lowerre-Barbieri et al., 2022). Peak spawning months were previously identified as June through August (Kulaw et al., 2017, Glenn et al., 2017; SEDAR52, 2018), but in this assessment, also included September, which had a 59% spawning fraction.

Analysis to assess the best data to include in maturity models indicated that the use of peak spawning months and assignment of early developing as immature was less effective than restricting the reproductive phases used to immature and spawning (Lowerre-Barbieri et al., 2022). Therefore, both age and length at maturity models were calculated using only these reproductive phases and no temporal filter. Age at 50% maturity (A50) increased over time in

both regions, with fish in the Western Gulf consistently having higher A50s than those from the Eastern Gulf (Table 5; Figure 18). Estimated A50 in the Eastern Gulf increased from 1.36 y (fractional age) in the overfished period to 1.44 y in the rapidly recovering period, to 1.93 y in the stabilizing period. In the Western Gulf, A50 increased from 1.52 y in the overfished period to 1.71 y in the rapidly recovering period to 2.46 y in the final period. In addition, the shape of the curves changed with time, with more gradual changes in proportion mature as the stock recovered. The A50 estimate for the time-and-space-aggregated model was 1.64 y (Table 5).

As with age-at-maturity, the length-at-maturity models supported the existence of the period-and-region effect and an increasing length at 50% maturity (L50) by period. However, unlike the age model, estimated length-at-maturity was higher in the East than the West for all but the additive model (Table 6). Generally, the L50 estimates were similar between the additive, interaction, and random effects model, with the random effects model estimating a higher L50 for the period/region combinations that the models generally had a hard time fitting (i.e., the early period in the East and the mid period in the West). As with the age model, the predicted relationship of length at maturity became less steep with time (Figure 19). The L50 in the East was estimated to be 25.6 cm in the overfished period, 28 cm in the rapidly recovering period, and 32.8 cm in the stabilizing period. In the West, the estimates were 22 cm in the overfished period, 23.8 cm in the rapidly recovering period, and 31.5 cm in the stabilizing period. The L50 estimate for the time-and-space-aggregated model was 28.3 cm fork length (Table 6).

The models of Porch et al. (2007) and Porch et al. (2015) were extended to model batch fecundity (BF) and spawning frequency over space and time (Lowerre-Barbieri and Friess, 2022). Although BF increased with length and condition ( $pd = 100\%$  and  $\% \text{ in ROPE} = 0$ , table 7), the effects of region and period are not easily summarized due to the interaction between region, period, and length. The fit to the log-transformed values of batch fecundity and fork length was good (Figure 20), as was the fit to the back-transformed values, but higher values of BF tended to be underestimated, especially for the West in the early period (Figure 20) and this was exaggerated when length was converted to age (Figure 21).

Predicted spawning fraction increased with age, was larger in the East than the West, and decreased as the stock recovered for fish younger than age 16 y (Table 8). Models where both slope and intercept were allowed to vary had trouble converging. Predicted spawning fraction was generally similar to observed for younger ages. Spawning fraction at age was better estimated than at length, and both models had high uncertainty when samples were sparse. The length models had trouble fitting the lower proportions with spawning markers at smaller sizes in the East in the middle and later periods, overestimated proportion with spawning markers at larger sizes in the early period in the East, and underestimated proportions with spawning markers at larger sizes in the West in the middle and later period (Figure 22).

Both estimated fecundity-at-length and fecundity-at-age vectors showed a trend of decreasing fecundity over time within region, and higher relative fecundity at length and age in the Eastern than the Western Gulf (Figure 23). The fecundity-at-age vector used in SEDAR 31 and 52 was most similar to model results for the overfished period and quite a bit higher than results observed in the rapidly recovering and stabilizing period. This, in combination with the uncertainty in fecundity estimates due to methodological issues as well as insufficient data for all age groups, particularly fish >10 years, led to our recommendation to use SSB as the best measure of reproductive potential.

#### 2.4.1 Recommendations for SEDAR 74

Adopt the slightly modified reproductive phase names and criteria from Lowerre-Barbieri et al. (2022).

Adopt the standardized methodology from Lowerre-Barbieri et al. (2022) to estimate spawning season and peak spawning months.

Maturity models should only use immature and spawning females (i.e., those with spawning markers) if sample size allows, rather than filtering data by peak spawning season, as recommended in Lowerre-Barbieri et al. (2022).

Given the uncertainty in the fecundity-at-age vectors over time, utilize SSB as the measure of reproductive potential (Lowerre-Barbieri and Friess, 2022).

#### 2.4.2 Research Recommendations

Standardize data fields on the template, as well as limiting them to the data needed. It is especially important that data providers QA/QC their own data prior to submitting to ensure multiple fields are not used for the same parameter.

Additional histological sampling is needed from the east region (FL west coast to Cape San Blas) to allow analyses by three regions.

Conduct batch fecundity estimates only on females in late oocyte maturation without POFs (histological analysis of ovaries used for batch fecundity is needed). Preserve ovaries only in formalin rather than Gilson's or freezing them. Use the washing process presented in Lowerre-Barbieri et al. (1993) for separating out the OM oocytes for fecundity estimates, which works equally well for fresh or preserved ovaries.

Research on Red Snapper spawning marker duration, as well as selectivity of fish with spawning markers is needed to improve estimates of spawning frequency.

## 2.5 NATURAL MORTALITY

Multiple studies have validated the longevity of different reef fishes using  $\Delta^{14}\text{C}$  decay curves, with GOM red snapper longevity validated to at least 45 yrs. (Barnett et al. 2018; Andrews et al. 2019). The method used to directly estimate observed age in bomb radiocarbon studies of red snapper otoliths (i.e., observed annuli counts) was the same method used to produce production age estimates as well as to produce the maximum age estimate of 57 yrs. The maximum age sample was evaluated by multiple experienced readers (Allman personal communication). Therefore, the maximum age estimate of 48 used in SEDAR 52 was increased to 57 yrs for SEDAR 74.

Given this new longevity estimate, the average natural mortality rate ( $M$ ) over the fishable lifespan of red snapper was estimated from several regression equations of longevity versus size- or weight-at-age. From Hoenig (1983),  $M$  for red snapper with a max age of 57 resulted in an  $M$  value of  $0.0796 \text{ yr}^{-1}$ ;  $M$  was estimated as  $0.0526 \text{ yr}^{-1}$  with the method of Hewitt and Hoenig (2005). The Then et al. (2015) method is an updated regression equation from Hoenig's (1983) equation, but estimated from a much wider range of fishes, regions, and habitats. The Then et al. (2015) method resulted in an  $M$  value estimate of  $0.1206 \text{ yr}^{-1}$  when using the regression equation developed for all fishes (excluding the pygmy goby, *Eviota sigillata*,  $M = 49.57 \text{ yr}^{-1}$ ),  $0.1207 \text{ yr}^{-1}$  from reef fish-specific regression parameters, and  $0.1040 \text{ yr}^{-1}$  from Lutjanid-specific parameters. The Lutjanid-specific estimate of average  $M$  was recommended by the life-history group for use as the estimate of  $M$  in SEDAR 74. Following the recommendations put forth in SEDAR 52, Age-2 was recommended as the first age fully selected by the fishery. Therefore, the Lorenzen age-specific natural mortality function (Lorenzen 1996) was scaled to the Then et al. (2015) estimate for ages 2-57 yrs (Figure 24). Natural mortality for ages 0 and 1 were fixed to 2.0 and  $1.2 \text{ yr}^{-1}$ , following the recommendation in SEDAR 52. The final natural mortality vector resulted in a maximum age cumulative survival of only 0.1%. However, this estimate was deemed reasonable for a species like red snapper based on its life history (i.e., rapid growth, early maturity, long-lived, low natural mortality, and infrequent strong year classes), and considering that only a very small number of individuals have been observed to exceed 45 yrs of age despite having collected hundreds of thousands of age samples from both fishery independent and dependent sources spanning several decades.

### 2.5.1 Recommendations for SEDAR 74

Use the observed maximum age of 57 years when estimating age-specific  $M$ .

Estimate a single  $M$  value and age-specific vector for all regions.

Use the Then et al. (2015) method to estimate  $M$  using Lutjanid-specific parameters.

Scale Then et al. (2015) derived estimate of  $M$  to age-specific values using Lorenzen function (1996).

While important questions remain about density dependent effects on juvenile red snapper mortality, no new studies of age-0 and age-1 red snapper natural mortality were identified. All of

the identified existing studies were considered in previous assessments, and their results are in line with the natural mortality rates for age-0 and age-1 red snapper used in SEDAR 31 and 52. Therefore, we recommend using  $M = 2.0$  for age-0 and  $M = 1.2$  for age-1 red snapper.

### 2.5.2 Research Recommendations

We recommend additional effort to collect age-0 and age-1 red snapper to better estimate natural mortality rates and density dependent responses.

## 2.6 EPISODIC EVENTS

Periodic environmental perturbations can influence the survival and catchability of Gulf of Mexico red snapper. Recent studies have described the influence of seasonal hypoxic events and the effects of the Deepwater Horizon (DWH) oil spill on red snapper. A geostatistical modeling approach was used to estimate the extent of hypoxic events during midsummer from 1985-2011 in the northern Gulf of Mexico and found an increasing trend in the thickness of the midsummer hypoxic zone (Obenour et al. 2013). Szedlmayer and Mudrak (2014) recorded that oxygen concentrations fell to as low 0.4 mg/L on experimental artificial reefs off Alabama, which coincided with the almost complete absence of age-0 red snapper in August 2011. Switzer et al. (2015) reported differences in juvenile recruitment annually in the northern Gulf of Mexico with the lowest levels during years with severe hypoxia. However, it was unclear if these declines in juvenile recruitment were observed later in the fishery.

Lewis et al. (2020) noted changes in marine community structure after DWH. In particular, generalist carnivores such as red snapper declined in number with little evidence of recovery 7 years after DWH. They suggested predation by lionfish as a factor contributing to delayed recovery. Tarnecki and Patterson (2015) noted changes in the diet and trophic ecology of red snapper following DWH. Specifically, red snapper consumed less zooplankton on artificial and natural habitats, increased consumption of benthic prey on natural habitats, and increased fish consumption on artificial reefs. Tarnecki and Patterson (2015) stated that changes in red snapper prey abundance following DWH were likely the reason for the observed changes in diet and the resulting trophic level. The abundance of age-0 and age-1 red snapper observed off Alabama the summer after DWH in 2010 and in 2011 did not show evidence of recruitment failure; declines in numbers after DWH for age-0 and age-1 fish were most associated with low dissolved oxygen (Szedlmayer and Mudrak 2014). Herdter et al. (2017) compared growth of adult red snapper from before and after DWH, and found no difference between von Bertalanffy growth curves from the back-calculated pre-period and from after the DWH oil spill. However, increment widths for dominant cohorts (fourth, fifth, and sixth year increments) did decline significantly post-DWH by 13%, 15%, and 22%, respectively, and were significantly smaller than the mean width of each respective increment in years prior to DWH.

The LHG also discussed other episodic events, which may affect the survival and catchability of red snapper. These include the influence of hurricanes on movement patterns, habitat, and changes in fisher behavior. Other topics discussed as potential factors influencing red snapper were increased freshwater discharge through the Bonnet-Carrie spillway in recent years and increased Mississippi River discharge possibly due to climate change. The NOAA Southeast Fisheries Science Center used in-depth conversations with charter captains throughout the Gulf to create conceptual models of the Red Snapper fishery, including important drivers and linkages (Gervasi et al. 2022, SEDAR74-DW-16). Several episodic events were mentioned that may influence red snapper life history and/or fishery dynamics.

Hurricanes have varied impacts on the red snapper fishery according to recreational charter-for-hire captains. Hurricanes can dislodge smaller artificial structures, which are the main habitats anglers target for red snapper in most regions. When the number of structures with known locations declines after a hurricane, it can lead to a decrease in red snapper catchability as anglers have to move to structures further away or locate new structures. This would particularly be the case for regions that have high dependence on artificial structures (Mississippi, Alabama, and the Florida Panhandle). Captains also mentioned that hurricanes may move red snapper around, either moving fish closer to shore or further offshore depending on the direction and intensity of the hurricane. This observation aligns with a tagging study that examined the movements of red snapper during Hurricane Opal off the coast of Alabama (Watterson et al. 1998). The authors found that storm effect was the most significant factor predicting the likelihood of red snapper movement away from the artificial reef study site, as well as the magnitude of movement. Fish that were at liberty during the hurricane moved significantly further than fish that were not at liberty during the hurricane. One captain also mentioned that hurricanes may increase larval recruitment, thereby increasing local abundance of red snapper in the region. However, the mechanisms by which this occurs were unknown. Perhaps hurricane wind speed could be used as a metric for estimating the extent to which artificial structures, and the red snapper associated with them, are redistributed in a given year. Storm energy in the north central GOM, as measured by the accumulated cyclone energy index, was particularly high in recent years (2018 and 2020) which could explain why numerous charter captains mentioned hurricanes as major drivers of the red snapper fishery. Water quality was mentioned by two captains from Alabama and Louisiana as possibly impacting red snapper local abundance. The captains observed that when freshwater flow from the large river systems of the northeastern GOM is high, it can lead to a decrease in water quality and a decrease in the abundance of red snapper close to shore. Brown-Peterson et al. (2022) have shown a decrease in female Red Snapper that have recently spawned with increases in phosphate, dissolved inorganic nitrogen, dissolved oxygen, and salinity in offshore waters, conditions that are likely driven by increased freshwater outflow from river systems.

### 2.6.1 Research Recommendations

Further research is needed on the effects of episodic events on all life stages of red snapper.

## 2.7 CONVERSIONS

Length and weight conversions were updated using data through 2019 from the NOAA Panama City biological database and the NOAA Bio Sample Database (Table 9).

## 2.8 LITERATURE CITED

- Allman, R.J., G.R. Fitzhugh, K.J. Starzinger and R.A. Farsky. 2005. Precision of age estimation in red snapper (*Lutjanus campechanus*). *Fisheries Research* 73:123-133.
- Andrews, A.H., C. Yeman, C. Welte, B. Hatterdorf, L. Wacker and M. Christl. 2019. Laser ablation–accelerator mass spectrometry reveals complete bomb  $\Delta^{14}\text{C}$  signal in an otolith with confirmation of 60-year longevity for red snapper (*Lutjanus campechanus*). *Marine and Freshwater Research* 70, 1768-1780.
- Barnett, B. K., Thornton, L., Allman, R., Chanton, J. P., and Patterson, W. F.III 2018. Linear decline in red snapper (*Lutjanus campechanus*) otolith  $\Delta^{14}\text{C}$  extends the utility of the bomb radiocarbon chronometer for fish age validation in the Northern Gulf of Mexico. *ICES Journal of Marine Science* 75, 1664–1671. doi:10.1093/ICESJMS/FSY043
- Beamish, R.J. and D.A. Fournier. 1981. A method for comparing the precision of a set of agedeterminations. *Canadian Journal of Fisheries and Aquatic Science* 38:982-983.
- Bortone, S.A. and C.L. Hollingsworth. 1980. Ageing red snapper, *Lutjanus campechanus*, with otoliths, scales and vertebrae. *Northeast Gulf Science* 4(1):60-63.
- Brown-Peterson, N.J., R.T. Leaf, and A.J. Leontiou. 2021. Importance of depth and artificial structure as predictors of female Red Snapper reproductive parameters. *Transactions of the American Fisheries Society*. 150(1):115-129. <https://doi.org/10.1002/tafs.10277>.
- Brown-Peterson, N.J. and A.K. Millender. 2022. The Reproductive Biology of Red Snapper in Mississippi Waters. SEDAR74-DW09. SEDAR, North Charleston, SC. 34 p.
- Brown-Peterson, N.J., C.R. Peterson, and G.R. Fitzhugh. 2019. Multidecadal meta-analysis of reproductive parameters of Red Snapper (*Lutjanus campechanus*) in the northern Gulf of Mexico. *Fishery Bulletin* 117:37-49. <https://doi.org/10.7755/FB.117.1.5>
- Brown-Peterson, N.J., W. Wu, C. Slife, K.S. Dillon and A.J. Leontiou. 2022. Variations in Red Snapper oocyte development and spawning in relation to environmental and habitat parameters. *Environmental Biology of Fishes* 105:in press.
- Brown-Peterson, N.J., D. Wyanski, F. Saborido-Rey, B. Macewicz, and S.K. Lowerre-Barbieri. 2011. A standardized terminology for describing reproductive development in fishes. *Marine and Coastal Fisheries: Dynamics, Management, and Ecosystem Science* 3:52-70.
- Diaz, G.A., C.E. Porch, and M. Ortiz. 2004. Growth models for red Snapper in U.S. Gulf of Mexico waters estimated from landings with minimum size limit restrictions. NMFS/SEFSC/SFD 2004-038, 13 p.



- Downey, C.H., M.K. Streich, R.A. Brewton, M.J. Ajemian, J.J. Wetz, and G.W. Stunz. 2018. Habitat-specific reproductive potential of Red Snapper: A comparison of natural and artificial reefs in the western Gulf of Mexico. *Transactions of the American Fisheries Society* 147:1030-1041. <https://doi.org/10.1002/tafs.10104>
- Fischer, A.J., Baker, M.S. and C.A. Wilson 2004. Red snapper (*Lutjanus campechanus*) demographic structure in the northern Gulf of Mexico based on spatial patterns in growth rates and morphometrics. *Fishery Bulletin* 102:593-603.
- Froehlich C.Y.M., A.M. Lee, R. Oquita, C.E. Cintra-Buenrostro, and J.D. Shivley. 2021. Reproductive characteristics of Red Snapper *Lutjanus campechanus* on artificial reefs in different jurisdictions. *Regional Studies in Marine Science* 47:101936. <https://doi.org/10.1016/j.rsma.2021.101936>
- Futch, R.B. and G.E. Bruger. 1976. Age, growth and reproduction of red snapper in Florida waters. Pages 165-183 *in*: H.R. Bullis Jr. and A.C. Jones (eds.) *Proceedings: Colloquium on snapper-grouper fishery resources of the western central Atlantic Ocean*. Florida Sea Grant College Program Report No. 17, Gainesville, Florida.
- Garner, S.B., R.J. Allman and B.K. Barnett and N. Willett. 2022. Description of age, growth, and natural mortality of Red Snapper from the northern Gulf of Mexico 1980 and 1986. SEDAR74-DW-34. SEDAR, North Charleston, SC. 33 pp.
- Gervasi, C., M. McPherson, and M. Karnauskas. 2022. System dynamics of red snapper populations in the Gulf of Mexico to support ecosystem considerations in the assessment and management process. SEDAR74-DW-16. SEDAR, North Charleston, SC. 21 pp.
- Glenn H.D, J.H. Cowan, Jr., and J.E. Powers. 2017. A comparison of Red Snapper reproductive potential in the northwestern Gulf of Mexico: Natural versus artificial habitats. *Marine and Coastal Fisheries* 9:139–148. <https://doi.org/10.1080/19425120.2017.1282896>.
- Herdter, E.S., D.P. Chambers, C.D. Stallings and S.A. Murawski. 2017. Did the Deepwater Horizon oil spill affect growth of red snapper in the Gulf of Mexico? *Fisheries Research* 191:60-68.
- Hewitt, D.A. and J.M. Hoenig. 2005. Comparison of two approaches for estimating natural mortality based on longevity. *Fisheries Bulletin*. 103:433-437.
- Hoenig, J.M. 1983. Empirical use of longevity data to estimate mortality rates. *Fisheries Bulletin*. 82:898-903.
- Kulaw, D.H., J.H. Cowan, Jr., and M.W. Jackson. 2017. Temporal and spatial comparisons of the reproductive biology of northern Gulf of Mexico (USA) Red Snapper (*Lutjanus campechanus*) collected a decade apart. *PLoS One* 12:1–39. <https://doi.org/10.1371/journal.pone.0172360>.
- Leontiou, A.J., W. Wu and N.J. Brown-Peterson. 2021a. Immature and mature female Red Snapper habitat use in the north-central Gulf of Mexico. *Regional Studies in Marine Science* 44:101715, 8 p. <https://doi.org/10.1016/j.rsma.2021.101715>.

- Leontiou, A.J., W. Wu, and N.J Brown-Peterson. 2021b. The role of maturity in artificial habitat selection by female Red Snapper. *Marine and Coastal Fisheries* 13:332-344. <https://doi.org/10.1002/mcf2.10160>.
- Lewis, J.P., J.H. Tarnecki, S.B. Garner, D.D. Chagaris and W.F. Patterson III. 2020. Changes in reef fish community structure following the Deepwater Horizon oil spill. *Scientific Reports*. 10:5621. <https://doi.org/10.1038/s41698-020-62574-y>
- Lorenzen, K. 1996. The relationship between body weight and natural mortality in juvenile and adult fish: a comparison of natural ecosystems and aquaculture. *Journal of Fish Biology*. 49:627-647.
- Lowerre-Barbieri, S. and C. Friess. 2022. Modeling fecundity at age in Gulf of Mexico Red Snapper to help evaluate the best measure of reproductive potential. SEDAR74-DW-36. SEDAR, North Charleston, SC. 43 p.
- Lowerre-Barbieri, S.K., C. Friess, N. Brown-Peterson, H. Moncrief-Cox, and B. Barnett. 2022. Best practices for standardized reproductive data and methodology to estimate reproductive parameters for Red Snapper in the Gulf of Mexico. SEDAR74-DW-36. SEDAR, North Charleston, SC. 43 p.
- Lowerre-Barbieri, S.K., K. Ganas, F. Saborido-Rey, H. Murua, and J.R. Hunter. 2011. Reproductive timing in marine fishes: variability, temporal scales, and methods. *Marine and Coastal Fisheries: Dynamics, Management, and Ecosystem Science* 3:71-91.
- Manooch, C.S. III and J.C. Potts. 1997. Age and growth of red snapper, *Lutjanus campechanus*, Lutjanidae, collected along the southeastern United States from North Carolina through the east coast of Florida. *Journal of the Elisha Mitchell Society* 113(3):111-112.
- Millender, A.K. and N.J. Brown-Peterson. 2022. Reproductive parameters of female Red Snapper differ across depth. *Proceedings of the Gulf and Caribbean Fisheries Institute* 74:in press.
- Nelson, R.S. and C.S. Manooch III. 1982. Growth and mortality of red snappers in the west-central Atlantic Ocean and northern Gulf of Mexico. *Transactions of the American Fisheries Society* 111:465-475.
- Obenour, D.R., D. Scavia, N.N. Rabalais, R.E. Turner and A.M. Michalak. 2013. Retrospective analysis of midsummer hypoxic area in the northern Gulf of Mexico, 1985-2011. *Environmental Science and Technology* 47:9808-9815.
- Patterson, W.F. III., J.H. Cowan Jr., C.A. Wilson, and R.L. Shipp. 2001. Age and growth of red snapper, *Lutjanus campechanus*, from an artificial reef area off Alabama in the northern Gulf of Mexico. *U.S. Fishery Bulletin* 99:617-627.
- Porch, C.E. 2007. An assessment of the Red Snapper fishery in the U.S. Gulf of Mexico using a spatially-explicit age-structured model. *American Fisheries Society Symposium* 60:355-384.
- Porch, C.E., G.R. Fitzhugh, E.T. Lang, H.M. Lyon, and B.C. Linton. 2015. Estimating the dependence of spawning frequency on size and age in Gulf of Mexico Red Snapper. *Marine and Coastal Fisheries* 7: 233-245.

- SEDAR7 2005. Stock Assessment Report of SEDAR 7 Gulf of Mexico Red Snapper (SEDAR One Southpark Circle #306 Charleston, SC 29414 Southeast Data, Assessment, and Review).
- SEDAR31 2013. Gulf of Mexico Red Snapper Stock Assessment Report. SEDAR, North Charleston SC. 1103 p.
- SEDAR52 2018. SEDAR 52: Stock assessment report Gulf of Mexico Red Snapper. North Charleston, SC 435 p.
- Switzer, T.S., E.J. Chesney and D.M. Baltz. 2015. Habitat use by juvenile red snapper in the northern Gulf of Mexico: ontogeny, seasonality, and the effects of hypoxia. *Transactions of the American Fisheries Society* 144:300-314.
- Szedlmayer S.T. and P.A. Mudrak. 2014. Influence of Age-1 Conspecifics, Sediment Type, Dissolved Oxygen, and the Deepwater Horizon Oil Spill on Recruitment of Age-0 Red Snapper in the Northeast Gulf of Mexico during 2010 and 2011, *North American Journal of Fisheries Management*, 34:2, 443-452.
- Tarnecki, J.H. and Patterson, W.F. III. 2015. Changes in red snapper diet and trophic ecology following the Deepwater Horizon oil spill. *Marine and Coastal Fisheries*. 7:135-147.
- Then, A.Y., J.M Hoenig, N.G. Hall, D.A. Hewitt. 2015. Evaluating the predictive performance of empirical estimators of natural mortality rate using information on over 200 fish species. *ICES Journal of Marine Science*. 72:82-92.
- Watterson, J.C., W.F. Patterson III, R.L. Shipp, J.H. Cowan Jr. 1998. Movement of red snapper, *Lutjanus campechanus*, in the North Central Gulf of Mexico: Potential effects of hurricanes. *Gulf of Mexico Science* 16(1):92-104.
- Wilson, C.A. and D.L Nieland. 2001. Age and growth of red snapper, *Lutjanus campechanus*, from the northern Gulf of Mexico off Louisiana. *Fishery Bulletin* 99:653-664

## 2.9 TABLES

**Table 1.** Number of red snapper age samples by fishery (commercial, recreational, fishery independent, or unknown), subregion (West, Central, or East), and year.

Year	COM			REC			FI			UNK		
	W	C	E	W	C	E	W	C	E	W	C	E
1980	0	0	0	0	325	0	0	0	0	0	2	0
1986	0	0	0	348	1	1	0	0	0	0	0	0
1987	0	0	0	146	0	0	0	0	0	0	0	0
1988	0	0	0	350	1	0	0	0	0	0	0	0
1989	0	0	0	82	0	1	0	0	0	0	0	0
1990	0	0	0	36	0	0	0	0	0	0	0	0
1991	25	178	12	629	272	2	0	0	0	0	2	0
1992	210	116	34	511	441	5	0	7	0	22	2	0
1993	341	136	43	1236	632	62	5	0	0	0	0	0
1994	500	121	36	540	593	53	0	2	0	0	0	0
1995	97	85	26	147	371	0	0	21	0	0	0	0
1996	0	9	6	0	195	0	1	1	0	0	0	0
1997	0	1	41	0	157	1	36	1	0	0	0	0
1998	1519	235	36	1306	1857	2	1	16	0	0	0	0
1999	1873	902	172	435	1590	14	0	10	0	38	96	0
2000	1037	1381	111	255	647	3	76	115	0	50	77	0
2001	1205	1247	140	74	595	12	83	3	1	9	43	0
2002	4418	1165	182	772	3034	15	73	127	0	0	0	0
2003	3456	1500	177	968	6445	40	58	12	4	0	0	0
2004	3350	989	347	1195	4075	4	47	16	5	0	0	0
2005	2999	1131	379	1442	5331	57	357	423	4	0	0	0
2006	3362	1146	378	1524	3743	88	147	133	3	0	0	0
2007	1931	1211	178	1072	651	22	229	400	24	0	0	0
2008	2020	1147	343	940	542	63	355	234	30	0	0	0
2009	2528	949	1275	1178	960	372	253	450	337	13	22	6
2010	2293	1149	1461	876	1563	375	396	1487	460	0	0	35
2011	1695	2896	1052	1203	1403	385	2118	1385	311	0	0	17
2012	3110	3581	869	1512	2194	141	1890	1134	132	1	206	16
2013	1614	2063	1225	2399	2765	183	2656	1119	221	2	0	0
2014	1203	1792	1876	1986	4039	196	1445	1380	102	0	1	0
2015	1750	2386	1373	1834	4794	344	466	1544	141	0	0	0
2016	1806	2769	1633	1632	2486	73	566	1806	184	0	1	0
2017	1372	3167	1696	2032	1865	491	2308	1739	225	0	0	18
2018	1802	4253	1267	2178	2756	483	409	1828	307	0	0	0
2019	1801	4430	1730	1981	2750	410	331	1174	28	0	0	0

**Table 2.** Number of red snapper age samples by fishing mode (vertical line, longline, other, or unknown), subregion (West, Central, or East) and year (1980-2019).

Year	VL			LL			OT			UNK		
	W	C	E	W	C	E	W	C	E	W	C	E
1980	0	325	0	0	0	0	0	2	0	0	0	0
1986	348	1	1	0	0	0	0	0	0	0	0	0
1987	146	0	0	0	0	0	0	0	0	0	0	0
1988	350	1	0	0	0	0	0	0	0	0	0	0
1989	82	0	1	0	0	0	0	0	0	0	0	0
1990	36	0	0	0	0	0	0	0	0	0	0	0
1991	654	450	2	0	0	12	0	2	0	0	0	0
1992	721	544	23	0	0	15	22	22	1	0	0	0
1993	1548	768	75	29	0	30	5	0	0	0	0	0
1994	1034	714	81	0	0	8	6	2	0	0	0	0
1995	236	476	7	0	0	19	8	1	0	0	0	0
1996	0	205	0	1	0	6	0	0	0	0	0	0
1997	0	159	32	0	0	10	36	0	0	0	0	0
1998	2479	2054	13	347	0	25	0	54	0	0	0	0
1999	2232	2496	84	76	6	102	38	96	0	0	0	0
2000	950	2137	32	418	1	82	50	82	0	0	0	0
2001	1100	1830	77	262	15	76	9	43	0	0	0	0
2002	3173	4228	29	413	98	168	1106	0	0	571	0	0
2003	2354	7918	49	314	39	172	1396	0	0	418	0	0
2004	3059	5044	117	687	34	239	375	2	0	471	0	0
2005	4094	6761	127	252	35	313	18	89	0	434	0	0
2006	4102	4889	238	586	1	204	138	132	27	207	0	0
2007	2637	2016	89	392	93	135	70	153	0	133	0	0
2008	2517	1538	96	352	182	315	345	203	25	101	0	0
2009	3294	2112	1109	333	22	684	211	247	197	134	0	0
2010	2914	3484	1193	158	665	1082	320	50	56	173	0	0
2011	4104	4584	1135	867	981	572	25	119	58	20	0	0
2012	4585	5948	849	1257	995	253	607	166	56	64	6	0
2013	4053	4939	901	2041	927	679	577	81	49	0	0	0
2014	3303	5853	962	1216	1122	1124	115	237	88	0	0	0
2015	3508	7136	916	538	1348	808	4	240	134	0	0	0
2016	3421	5353	983	576	1450	860	7	209	47	0	50	0
2017	5279	5253	1698	433	1325	566	0	193	166	0	0	0
2018	3900	7110	1418	489	1663	588	0	64	51	0	0	0
2019	3249	7083	1361	864	1194	778	0	77	22	0	0	7

**Table 3.** Parameter estimates from von Bertalanffy size modified growth models (Diaz et al. 2004) fit to red snapper length (FL cm)-at-age (fractional, yr) data for a single stock, one region (Gulf of Mexico) model. The population model runs include all observations with year-specific size limits input for commercial and recreational fisheries. The fishery model runs include only observations from commercial or recreational fisheries. Variance parameter(s) were modeled with constant sigma, constant coefficient of variation (CV), CV as a linear function of age, or CV as a linear function of size-at-age. Weighting was used for a subset of each population or fishery model by taking the inverse of the count for each age-class in the dataset.

Model	Variance parameter	Parameters	Weighting	Region	N	Objective function value	AICc	ΔAICc	L <sub>∞</sub>	k	t <sub>0</sub>	varpar[1]	varpar[2]	Max gradient component
Population	Constant sigma	4	--	GOM	229519	732323.0	1464650.0	6000.0	77.50	0.2066	-0.170	7.553	--	3.20E-02
	Constant CV	4	--	GOM	229519	730571.0	1461150.0	2500.0	80.52	0.1680	-0.913	0.157	--	5.96E-02
	CV as linear function of age	5	--	GOM	229519	729418.0	1458850.0	200.0	81.59	0.1649	-0.884	0.172	0.001	1.97E-01
	CV as linear function of size-at-age	5	--	GOM	229519	729318.0	1458650.0	0.0	80.63	0.1731	-0.728	0.208	0.115	3.50E-04
	Constant sigma	4	Inverse	GOM	229519	3377.3	6762.6	4.2	81.00	0.1544	-1.121	6.010	--	1.16E-03
	Constant CV	4	Inverse	GOM	229519	3391.2	6790.5	32.0	79.97	0.1739	-0.980	0.079	--	1.13E-03
	CV as linear function of age	5	Inverse	GOM	229519	3375.2	6760.4	2.0	81.59	0.1458	-1.275	0.115	0.011	9.36E-07
	CV as linear function of size-at-age	5	Inverse	GOM	229519	3374.2	6758.4	0.0	<b>82.10</b>	<b>0.1407</b>	<b>-1.062</b>	<b>0.395</b>	<b>0.057</b>	8.64E-09

**Table 4.** Parameter estimates from von Bertalanffy size modified growth models (Diaz et al. 2004) fit to red snapper length (FL cm)-at-age (fractional, yr) data for a three subregion (West, Central, or East Gulf of Mexico) model. The population model runs include all observations with year-specific size limits input for commercial and recreational fisheries. Variance parameter(s) were modeled with constant sigma, constant coefficient of variation (CV), CV as a linear function of age, or CV as a linear function of size-at-age. Weighting was used for a subset of each population or fishery model by taking the inverse of the count for each age-class in the dataset.

Model	Variance parameter	Parameters	Weighting	Region	N	Objective function value	AICc	ΔAICc	$L_{\infty}$	k	$t_0$	varpar[1]	varpar[2]	Max gradient component
Population	Constant sigma	4	--	West	92690	299932.0	599873.0	676.0	76.56	0.2103	-0.056	7.899	--	3.30E-05
	Constant CV	4	--	West	92690	302351.0	604710.0	5513.0	76.71	0.1841	-0.732	0.156	--	7.27E+04
	CV as linear function of age	5	--	West	92690	300730.0	601471.0	2274.0	79.49	0.1717	-0.759	0.185	0.005	5.53E-04
	CV as linear function of size-at-age	5	--	West	92690	299593.0	599197.0	0.0	78.58	0.1847	-0.450	0.283	0.087	1.21E-03
	Constant sigma	4	--	Central	112434	350543.0	701095.0	9064.0	80.66	0.1789	-0.429	7.379	--	2.36E-01
	Constant CV	4	--	Central	112434	346092.0	692190.0	159.0	87.46	0.1354	-1.300	0.150	--	1.01E-02
	CV as linear function of age	5	--	Central	112434	346057.0	692124.0	93.0	87.77	0.1336	-1.331	0.148	0.202	1.01E-02
	CV as linear function of size-at-age	5	--	Central	112434	346011.0	692031.0	0.0	87.85	0.1323	-1.381	0.138	0.172	3.69E-06
	Constant sigma	4	--	East	24490	77592.3	155193.0	0.0	80.28	0.2092	-0.541	6.084	--	2.00E-03
	Constant CV	4	--	East	24490	78731.7	157471.0	2278.0	76.41	0.2206	-0.757	0.136	--	2.30E+04
	CV as linear function of age	5	--	East	24490	78043.6	156097.0	904.0	83.01	0.1825	-0.938	0.131	0.006	6.39E-03
	CV as linear function of size-at-age	5	--	East	24490	77703.0	155416.0	223.0	80.91	0.2010	-0.674	0.192	0.068	9.95E-05
Population	Constant sigma	4	Inverse	West	92690	159.5	327.0	14.3	81.30	0.1496	-1.150	5.460	--	4.65E-09
	Constant CV	4	Inverse	West	92690	168.3	344.6	31.8	80.30	0.1667	-0.997	0.094	--	4.48E-06
	CV as linear function of age	5	Inverse	West	92690	151.4	312.8	0.0	82.26	0.1449	-1.144	0.150	0.001	2.47E-05
	CV as linear function of size-at-age	5	Inverse	West	92690	153.1	316.3	3.5	<b>81.88</b>	<b>0.1361</b>	<b>-1.092</b>	<b>0.394</b>	<b>0.041</b>	1.00E-05
	Constant sigma	4	Inverse	Central	112434	165.9	339.8	2.9	85.55	0.1443	-1.133	6.198	--	1.05E+00
	Constant CV	4	Inverse	Central	112434	175.8	359.6	22.6	84.63	0.1506	-1.255	0.103	--	6.86E-06
	CV as linear function of age	5	Inverse	Central	112434	169.0	347.9	11.0	84.67	0.1499	-1.221	0.137	0.039	9.15E-06
	CV as linear function of size-at-age	5	Inverse	Central	112434	163.5	337.0	0.0	<b>85.43</b>	<b>0.1471</b>	<b>-1.020</b>	<b>0.318</b>	<b>0.057</b>	4.28E-05
	Constant sigma	4	Inverse	East	24490	104.8	217.6	0.0	85.77	0.1678	-0.794	6.054	--	1.38E-06
	Constant CV	4	Inverse	East	24490	112.3	232.5	14.9	84.11	0.1862	-0.694	0.113	--	1.34E-06
	CV as linear function of age	5	Inverse	East	24490	106.9	223.7	6.1	85.55	0.1726	-0.757	0.147	0.028	2.26E-06
	CV as linear function of size-at-age	5	Inverse	East	24490	104.8	219.6	2.0	<b>85.99</b>	<b>0.1659</b>	<b>-0.736</b>	<b>0.252</b>	<b>0.063</b>	2.64E-07

**Table 5.** Select age-at-maturity model comparison results. Covariate terms were period and region. The interaction model is the preferred mode with the lowest expected log pointwise density (elpd) based on 10-fold cross-validation, but it produced biologically unrealistic inflection point estimates for some period-region combinations. The random effects model where group-specific intercepts and slopes for region and period were estimated was chosen as the preferred model. 1– overfished (1991-2008; 2– rapidly recovering (2009-2016); 3–stabilizing (2017-2019).

Model	elpd_kfold	R <sup>2</sup>	A50					
			East			West		
			1	2	3	1	2	3
No covariates	-700.9	0.32	1.64					
Interaction	-574.6	0.43	0.57	1.63	2.00	1.71	0.76	2.06
Additive terms	-619.9	0.40	0.77	1.11	2.00	1.41	1.76	2.64
Random effects	-597.9	0.42	1.36	1.44	1.93	1.52	1.71	2.46

**Table 6.** Select length-at-maturity model comparison results. Covariate terms were period and region. The interaction model is the preferred mode with the highest expected log pointwise density (elpd) based on 10-fold cross-validation. We chose the random effects model as the best model to be consistent with age model results. Period 1– overfished (1991-2008; 2– rapidly recovering (2009-2016); 3–stabilizing (2017-2019).

Model	elpd_kfold	R <sup>2</sup>	I50					
			East			West		
			1	2	3	1	2	3
No covariates	-626.5	0.43	28.3					
Interaction	-463.5	0.57	23.7	28.5	32.9	21.9	21.3	31.0
Additive terms	-489.3	0.54	22.3	26.5	32.7	22.7	26.9	33.1
Random effects	-473.9	0.56	25.6	28.0	32.8	22.0	23.8	31.5



**Table 7.** Model parameter estimates and mcmc fit diagnostics for the batch fecundity-at-length model. The mean of the posterior predictive distribution (11.3) was nearly identical to the mean of the observed log batch fecundities (11.34). Rhat values (all less than 1.1) and effective sample size ( $n_{eff}$ ) values (all greater than 1000) suggest convergence and a large enough sample size for analysis, respectively.  $mcse$  = Monte Carlo standard error. Parameter estimates with certain direction ( $pd > 0.975$ ) and significance (% in ROPE  $< 0.025$ ) are highlighted.  $Pd$ =probability of direction. %ROPE= the percent of the posterior samples that fall within the region of practical equivalence.

	mean	<u>sd</u>	10%	50%	90%	<u>mcse</u>	<u>Rhat</u>	<u>n eff</u>	pd	% <u>in</u> ROPE
<b>(Intercept)</b>	<b>-12.60</b>	<b>1.90</b>	<b>-15.10</b>	<b>-12.60</b>	<b>-10.20</b>	<b>0</b>	<b>1</b>	<b>3429</b>	<b>1.00</b>	<b>0.00</b>
<b><u>log_fl</u></b>	<b>3.90</b>	<b>0.30</b>	<b>3.60</b>	<b>3.90</b>	<b>4.20</b>	<b>0</b>	<b>1</b>	<b>2192</b>	<b>1.00</b>	<b>0.00</b>
<b>period1</b>	<b>6.60</b>	<b>1.70</b>	<b>4.50</b>	<b>6.70</b>	<b>8.80</b>	<b>0</b>	<b>1</b>	<b>1888</b>	<b>1.00</b>	<b>0.00</b>
period2	-0.20	2.10	-2.90	-0.30	2.50	0	1	1824	0.55	0.06
<b>region1</b>	<b>-6.70</b>	<b>1.60</b>	<b>-8.80</b>	<b>-6.60</b>	<b>-4.60</b>	<b>0</b>	<b>1</b>	<b>1643</b>	<b>1.00</b>	<b>0.00</b>
method1	-0.30	0.20	-0.50	-0.30	0.00	0	1	4442	0.95	0.28
<b>month5</b>	<b>1.30</b>	<b>0.40</b>	<b>0.70</b>	<b>1.30</b>	<b>1.80</b>	<b>0</b>	<b>1</b>	<b>1279</b>	<b>1.00</b>	<b>0.00</b>
<b>month6</b>	<b>1.30</b>	<b>0.40</b>	<b>0.80</b>	<b>1.40</b>	<b>1.90</b>	<b>0</b>	<b>1</b>	<b>1221</b>	<b>1.00</b>	<b>0.00</b>
<b>month7</b>	<b>1.00</b>	<b>0.40</b>	<b>0.40</b>	<b>1.00</b>	<b>1.50</b>	<b>0</b>	<b>1</b>	<b>1238</b>	<b>0.99</b>	<b>0.00</b>
month8	0.60	0.40	0.10	0.60	1.20	0	1	1243	0.93	0.12
month9	0.20	0.40	-0.30	0.20	0.80	0	1	1234	0.71	0.28
month10	-0.80	0.60	-1.50	-0.80	0.00	0	1	1910	0.90	0.10
<b><u>log_rw</u></b>	<b>1.80</b>	<b>0.30</b>	<b>1.40</b>	<b>1.80</b>	<b>2.20</b>	<b>0</b>	<b>1</b>	<b>5851</b>	<b>1.00</b>	<b>0.00</b>
<b><u>log_fl:period1</u></b>	<b>-1.70</b>	<b>0.40</b>	<b>-2.20</b>	<b>-1.70</b>	<b>-1.10</b>	<b>0</b>	<b>1</b>	<b>1884</b>	<b>1.00</b>	<b>0.00</b>
<u>log_fl:period2</u>	-0.20	0.50	-0.90	-0.20	0.50	0	1	1833	0.65	0.24
<b><u>log_fl:region1</u></b>	<b>1.50</b>	<b>0.40</b>	<b>0.90</b>	<b>1.50</b>	<b>2.00</b>	<b>0</b>	<b>1</b>	<b>1627</b>	<b>1.00</b>	<b>0.00</b>
<u>period1:region1</u>	-1.70	2.50	-4.90	-1.80	1.40	0.1	1	1730	0.76	0.05
<u>period2:region1</u>	0.20	3.10	-3.60	0.20	4.20	0.1	1	1741	0.52	0.05
<u>log_fl:period1:region1</u>	0.50	0.60	-0.30	0.50	1.20	0	1	1721	0.77	0.17
<u>log_fl:period2:region1</u>	0.00	0.80	-1.00	0.10	1.00	0	1	1731	0.53	0.19
<b>sigma</b>	<b>1.20</b>	<b>0.00</b>	<b>1.10</b>	<b>1.20</b>	<b>1.20</b>	<b>0</b>	<b>1</b>	<b>5416</b>	<b>1.00</b>	<b>0.00</b>
<u>mean PPD</u>						0.0	1	4250		
<u>log-posterior</u>						0.1	1	1401		

**Table 8.** Predicted average daily spawning fraction by age, period, and region. Early–1991-2008, when the stock was severely overfished; Mid–2009-2016, when the stock was rapidly recovering; Late–from 2017-2019 as stock abundance began to stabilize.

Age	East, Early	East, Mid	East, Late	West, Early	West, Mid	West, Late
2	0.213	0.184	0.162	0.093	0.069	0.055
4	0.261	0.241	0.223	0.155	0.124	0.103
6	0.290	0.278	0.268	0.218	0.189	0.167
8	0.304	0.298	0.293	0.264	0.245	0.228
10	0.310	0.308	0.305	0.291	0.280	0.271
12	0.313	0.312	0.311	0.304	0.299	0.294
14	0.314	0.314	0.313	0.311	0.308	0.306
16	0.315	0.315	0.315	0.313	0.312	0.311
18	0.315	0.315	0.315	0.315	0.314	0.314
20	0.315	0.315	0.315	0.315	0.315	0.315

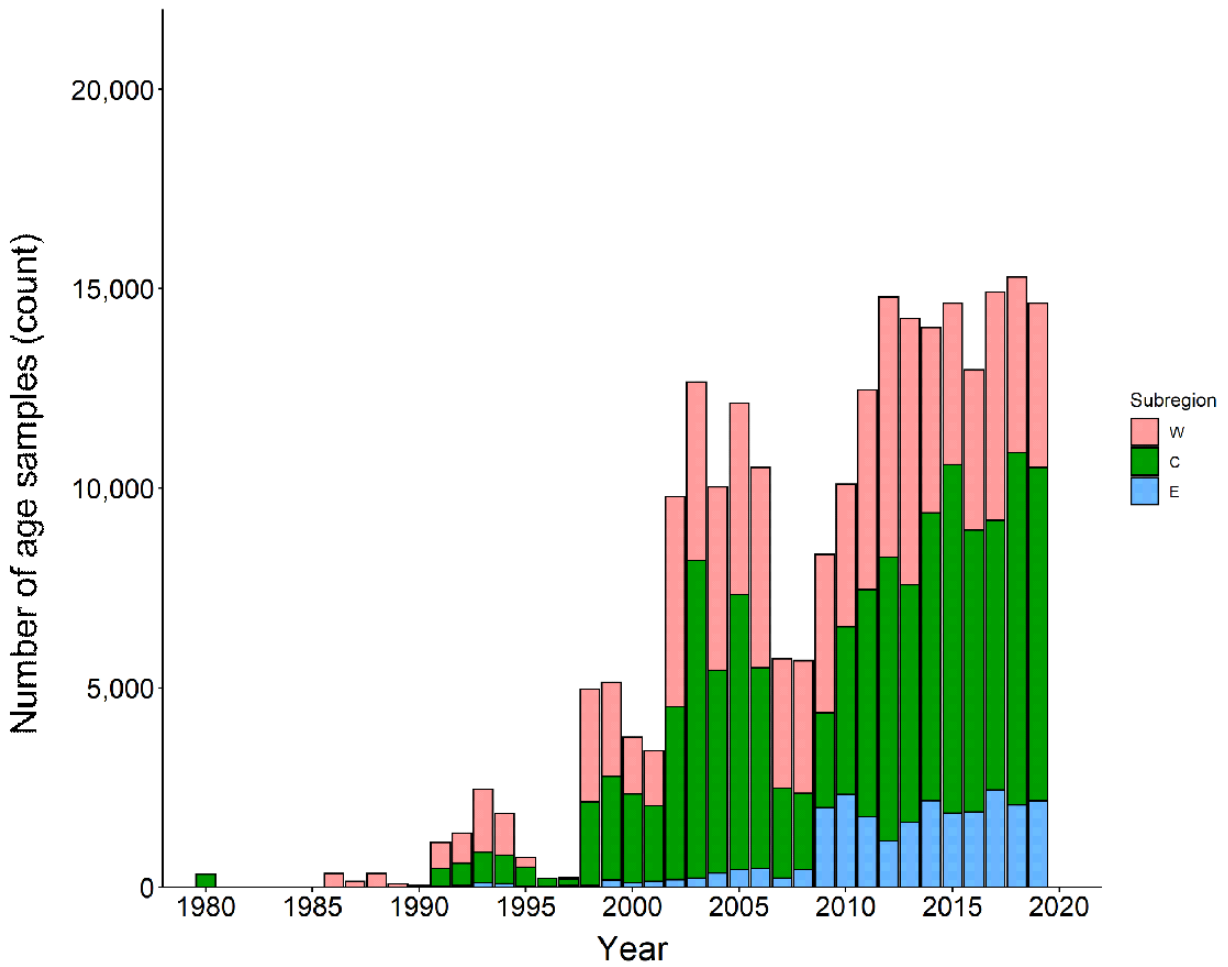
**Table 9.** Length and weight conversions for Gulf of Mexico red snapper.

Conversion	Units	Equation	n	a	b	Fit statistic	Data range	
MTL to FL	cm	FL=a+b*MTL	21286	0.138	0.926	r <sup>2</sup> = 0.998	MTL=4.1-99.4	FL=3.8-92.5
MTL to FL	in	FL=a+b*MTL		0.054	0.926		MTL=1.6-39.1	FL=1.5-36.4
SL to FL	cm	FL=a+b*SL	2842	1.756	1.137	r <sup>2</sup> = 0.987	SL=7.8-79.0	FL=9.5-89.0
SL to FL	in	FL=a+b*SL		0.692	1.137		SL=3.1-31.1	FL=3.7-35.0
NTL to FL	cm	FL=a+b*NTL	22327	-8.51E-02	0.930	r <sup>2</sup> = 0.993	NTL=16.3-97.6	FL=15.4-92.0
NTL to FL	in	FL=a+b*NTL		-3.35E-02	0.930		NTL=6.4-38.4	FL=6.1-36.2
SL to MTL	cm	MTL=a+b*SL	2253	1.968	1.228	r <sup>2</sup> = 0.986	SL=7.9-79.0	MTL=10.2-95.4
SL to MTL	in	MTL=a+b*SL		0.775	1.228		SL=3.1-31.1	MTL=4.0-37.6
SL to NTL	cm	NTL=a+b*SL	563	2.843	1.214	r <sup>2</sup> = 0.970	SL=23.5-77.5	NTL=31.1-92.0
SL to NTL	in	NTL=a+b*SL		1.119	1.214		SL=9.3-30.5	NTL=12.2-36.2
FL to NTL	cm	NTL=a+b*FL	22327	0.499	1.067	r <sup>2</sup> = 0.993	FL=15.4-92.0	NTL=16.3-97.6
FL to NTL	in	NTL=a+b*FL		0.196	1.067		FL=6.1-36.2	NTL=6.4-38.4
FL to MTL	cm	MTL=a+b*FL	21286	-4.86E-02	1.078	r <sup>2</sup> = 0.998	FL=3.8-92.5	MTL=4.1-99.4
FL to MTL	in	MTL=a+b*FL		-1.92E-02	1.078		FL=1.5-36.4	MTL=1.6-39.1
NTL to MTL	cm	MTL=a+b*NTL	NA	NA	NA	NA	NA	NA
NTL to MTL	in	MTL=a+b*NTL		0.133*	1.022*		NA	NA
GW to WW	kg	WW=a+b*GW	229	-0.123	1.115	r <sup>2</sup> = 0.996	GW=0.1-14.7	WW=0.1-16.5
GW to WW	lbs	WW=a+b*GW		-0.271	1.115		GW=0.1-32.4	WW=0.1-36.4
WW to GW	kg	GW=a+b*WW	229	0.1261	0.8934	r <sup>2</sup> = 0.996	GW=0.1-14.7	WW=0.1-16.5
WW to GW	lbs	GW=a+b*WW		0.2779	0.8934		GW=0.1-32.4	WW=0.1-36.4
SL to WW	kg, cm	WW=a*(SL <sup>b</sup> )	2799	6.78E-05	2.7667	RSE = 0.598	SL=12.1-79.0	WW=0.05-13.0
SL to WW	lbs, in	WW=a*(SL <sup>b</sup> )		1.97E-03	2.767	RSE = 1.319	SL=4.8-31.1	WW=0.1-28.7
FL to WW	kg, cm	WW=a*(FL <sup>b</sup> )	42716	1.60E-05	3.016	RSE = 0.343	FL=3.8-92.5	WW=0.001-16.5
FL to WW	lbs, in	WW=a*(FL <sup>b</sup> )		5.88E-04	3.016	RSE = 0.757	FL=1.5-36.4	WW=0.002-36.4
NTL to WW	kg, cm	WW=a*(NTL <sup>b</sup> )	27238	1.26E-05	3.020	RSE = 0.377	NTL=10.6-98.4	WW=0.02-15.5
NTL to WW	lbs, in	WW=a*(NTL <sup>b</sup> )		4.64E-04	3.020	RSE = 0.830	NTL=4.2-38.7	WW=0.04-34.2
MTL to WW	kg, cm	WW=a*(MTL <sup>b</sup> )	15407	1.01E-05	3.076	RSE = 0.380	MTL=4.1-98.5	WW=0.001-16.5
MTL to WW	lbs, in	WW=a*(MTL <sup>b</sup> )		3.92E-04	3.076	RSE = 0.837	MTL=1.6-38.8	WW=0.002-36.4
SL to GW	kg, cm	GW=a*(SL <sup>b</sup> )	NA	NA	NA	NA	NA	NA
SL to GW	lbs, in	GW=a*(SL <sup>b</sup> )		NA	NA	NA	NA	NA
FL to GW	kg, cm	GW=a*(FL <sup>b</sup> )	69896	1.45E-05	3.036	RSE = 0.208	FL=14.6-95.5	GW=0.06-15.9
FL to GW	lbs, in	GW=a*(FL <sup>b</sup> )		5.40E-04	3.036	RSE = 0.458	FL=5.7-37.6	GW=0.1-35.1
NTL to GW	kg, cm	GW=a*(NTL <sup>b</sup> )	2971	1.76E-05	2.929	RSE = 0.235	NTL=31.0-83.0	GW=0.3-8.7
NTL to GW	lbs, in	GW=a*(NTL <sup>b</sup> )		5.94E-04	2.929	RSE = 0.517	NTL=12.2-32.7	GW=0.7-19.2
MTL to GW	kg, cm	GW=a*(MTL <sup>b</sup> )	4906	7.08E-06	3.159	RSE = 0.320	MTL=15.4-99.4	GW=0.06-15.6
MTL to GW	lbs, in	GW=a*(MTL <sup>b</sup> )		2.97E-04	3.159	RSE = 0.705	MTL=6.1-39.1	GW=0.1-34.4

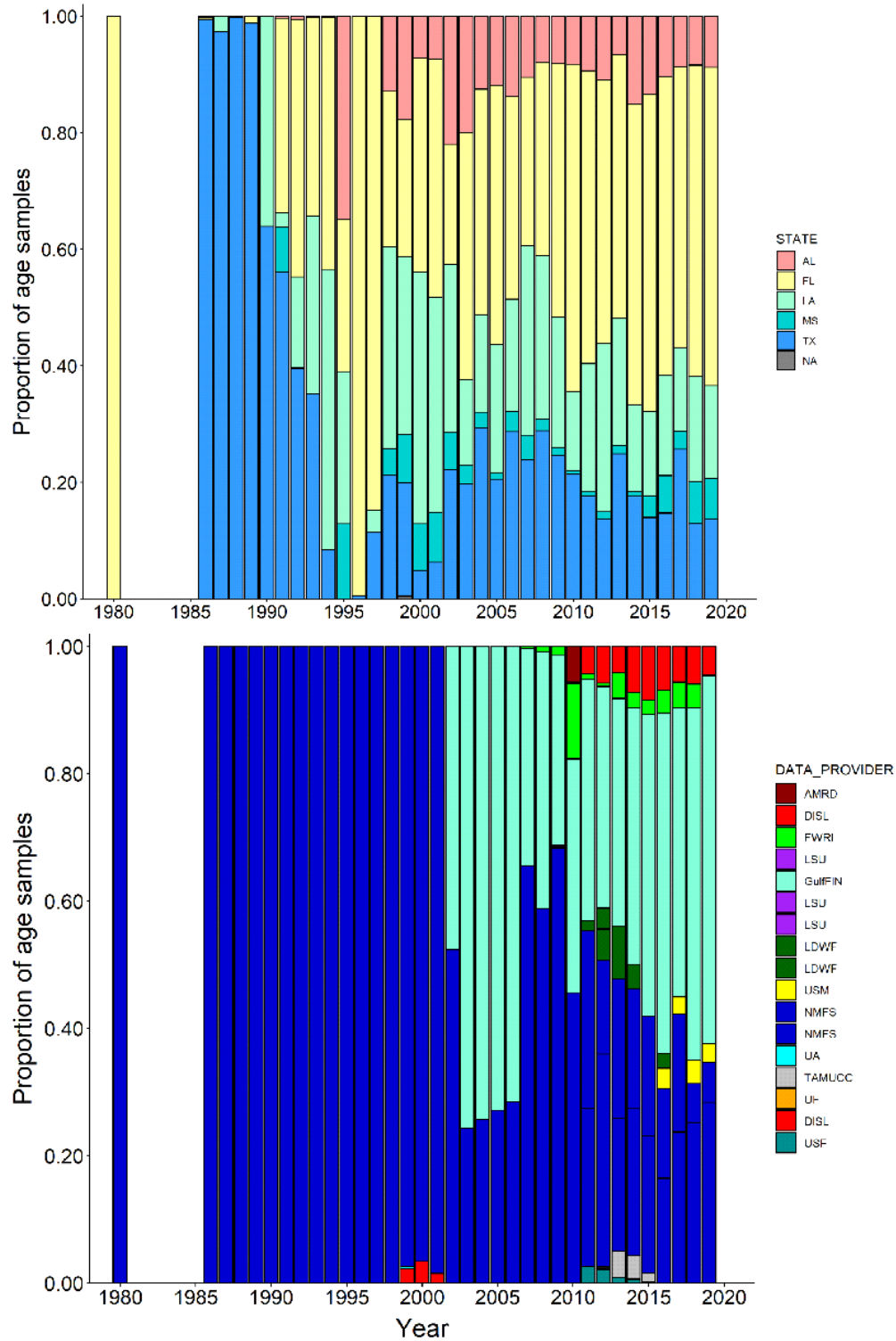
\* Values from SEDAR 31

2.10 FIGURES

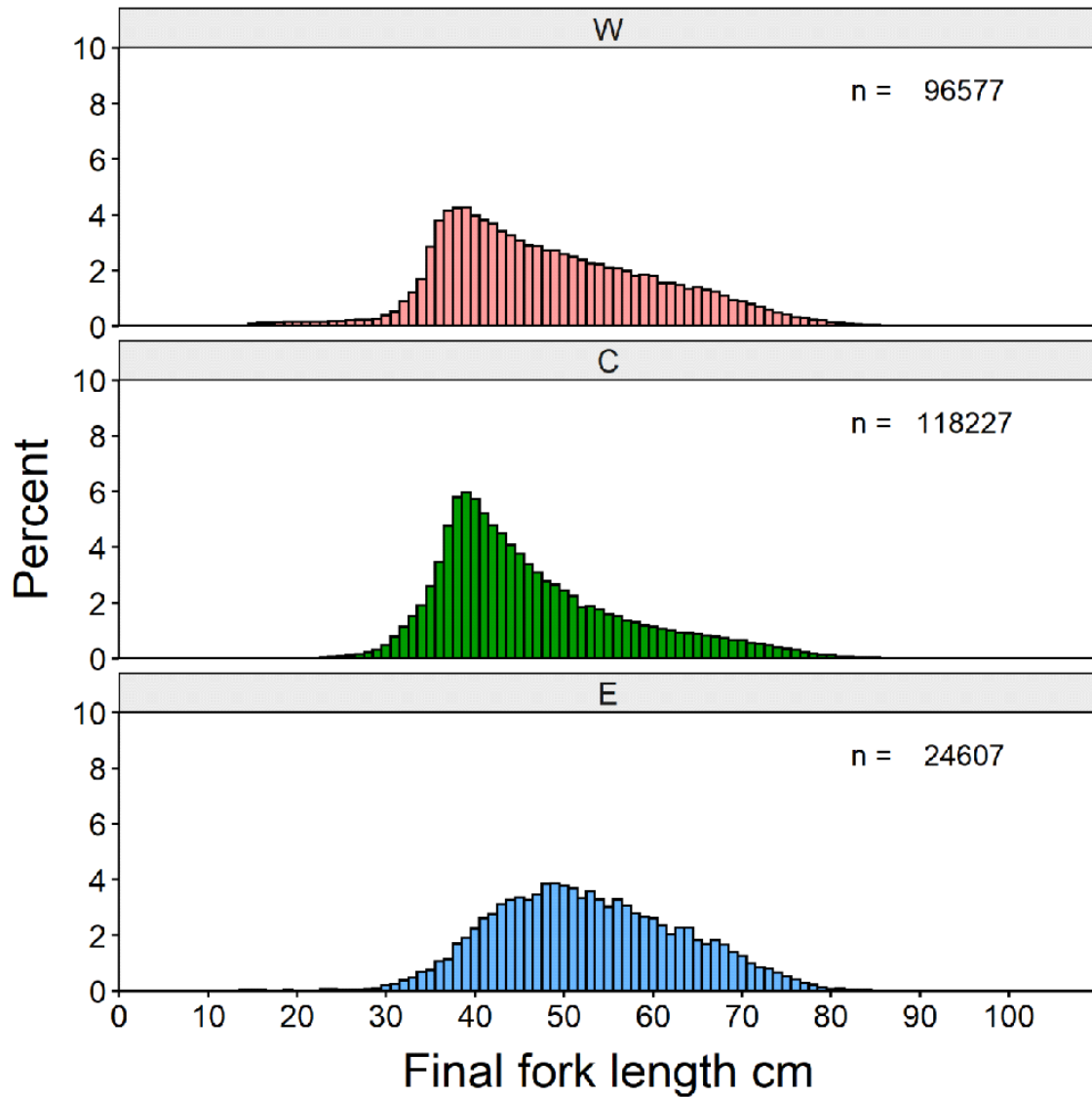
**Figure 1.** Number of age samples by West (W), Central (C), or East (E) subregion collected from the Gulf of Mexico in 1980 and from 1986 to 2019.



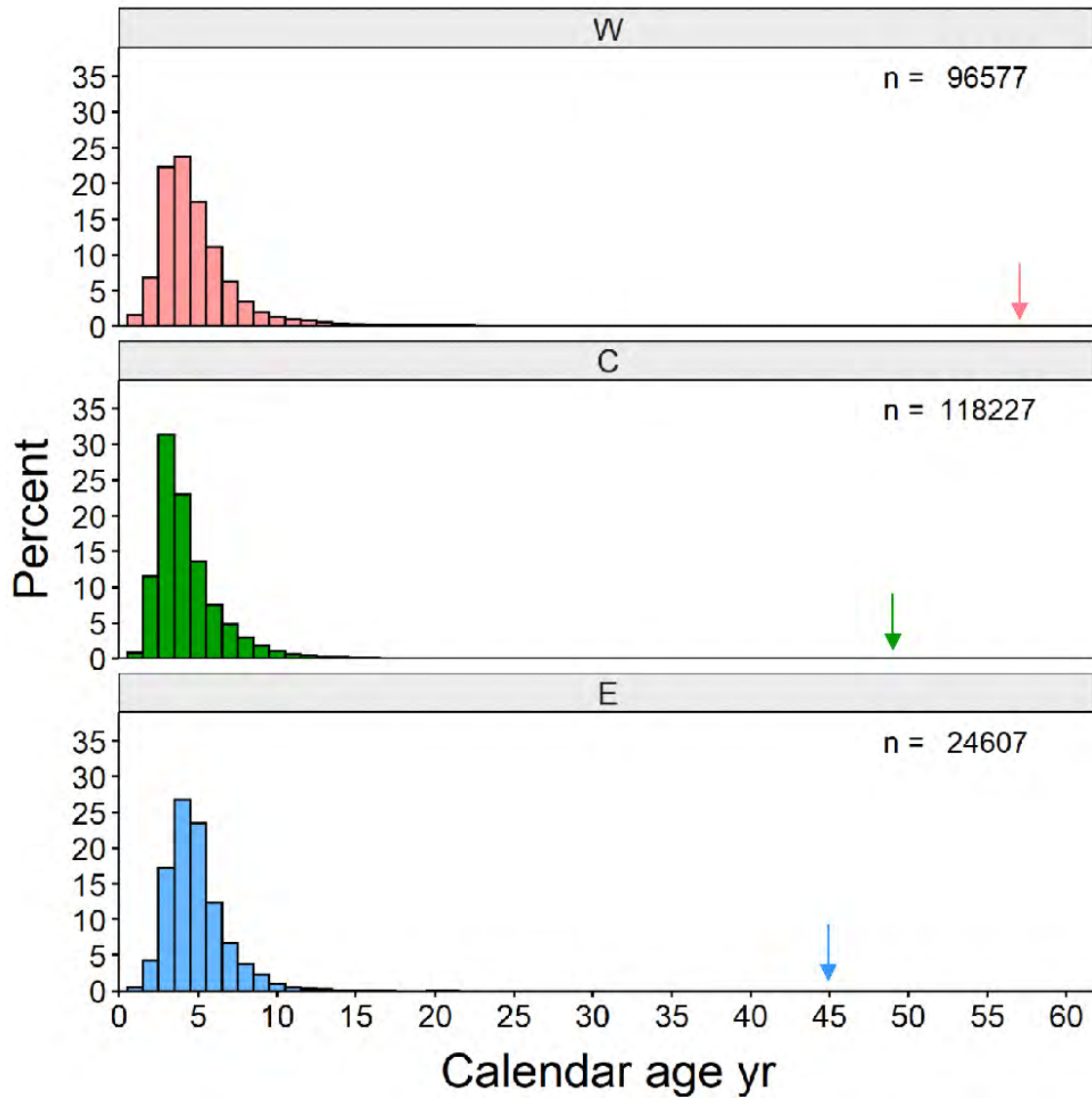
**Figure 2.** Proportion of red snapper age samples by state and data provider collected from the Gulf of Mexico in 1980 and from 1986 to 2019. Multiple labels from the same source indicate separate studies.



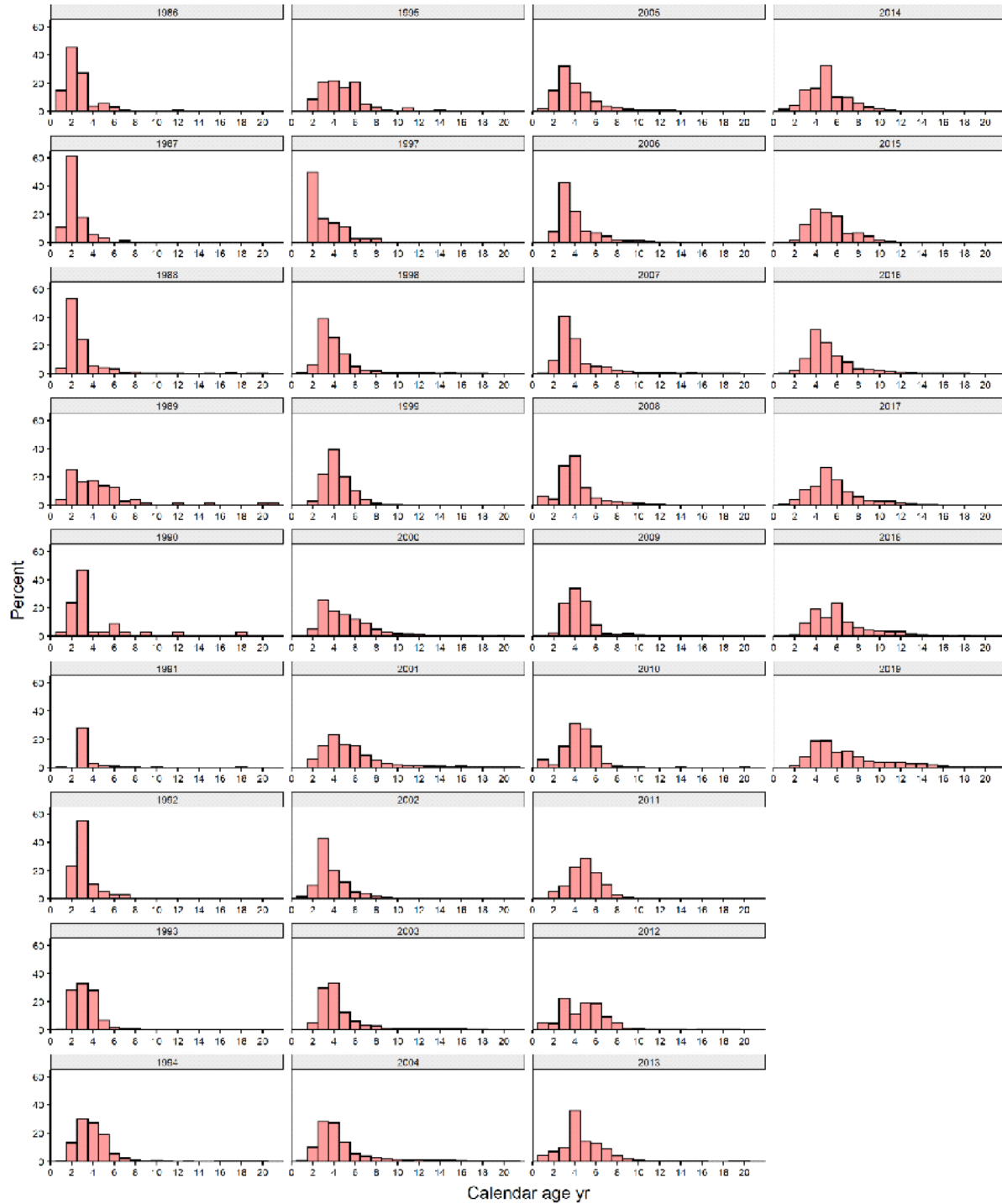
**Figure 3.** Frequency (%) histograms of final fork length (cm) by subregion (West, Central, or East) for red snapper age samples collected in the Gulf of Mexico in 1980 and from 1986 to 2019. Bin increments are equal to 2 cm.



**Figure 4.** Frequency (%) histograms of calendar age (yr) by subregion (West, Central, or East) for red snapper age samples collected in the Gulf of Mexico in 1980 and from 1986 to 2019. Bin increments are equal to 1 yr. Arrows represent maximum age observed in the West (57 yr), Central (49 yr), or East (45 yr) subregion.

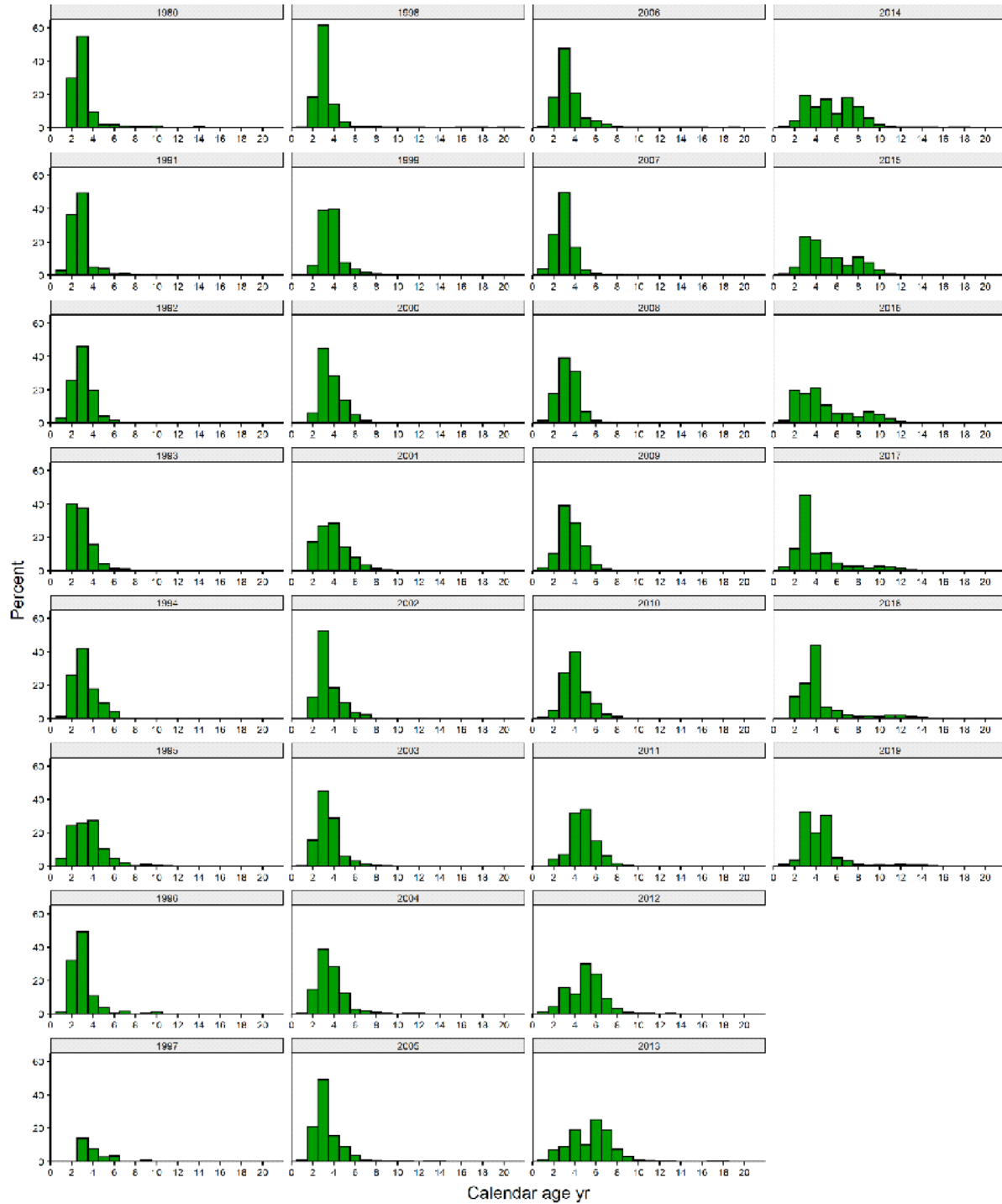


**Figure 5.** Frequency (%) histograms of calendar age (0 to 20 yrs) for red snapper age samples collected from the West subregion Gulf of Mexico in 1980 and from 1986 to 2019. Bin increments are equal to 1 yr. Years with <5 observations are not shown.

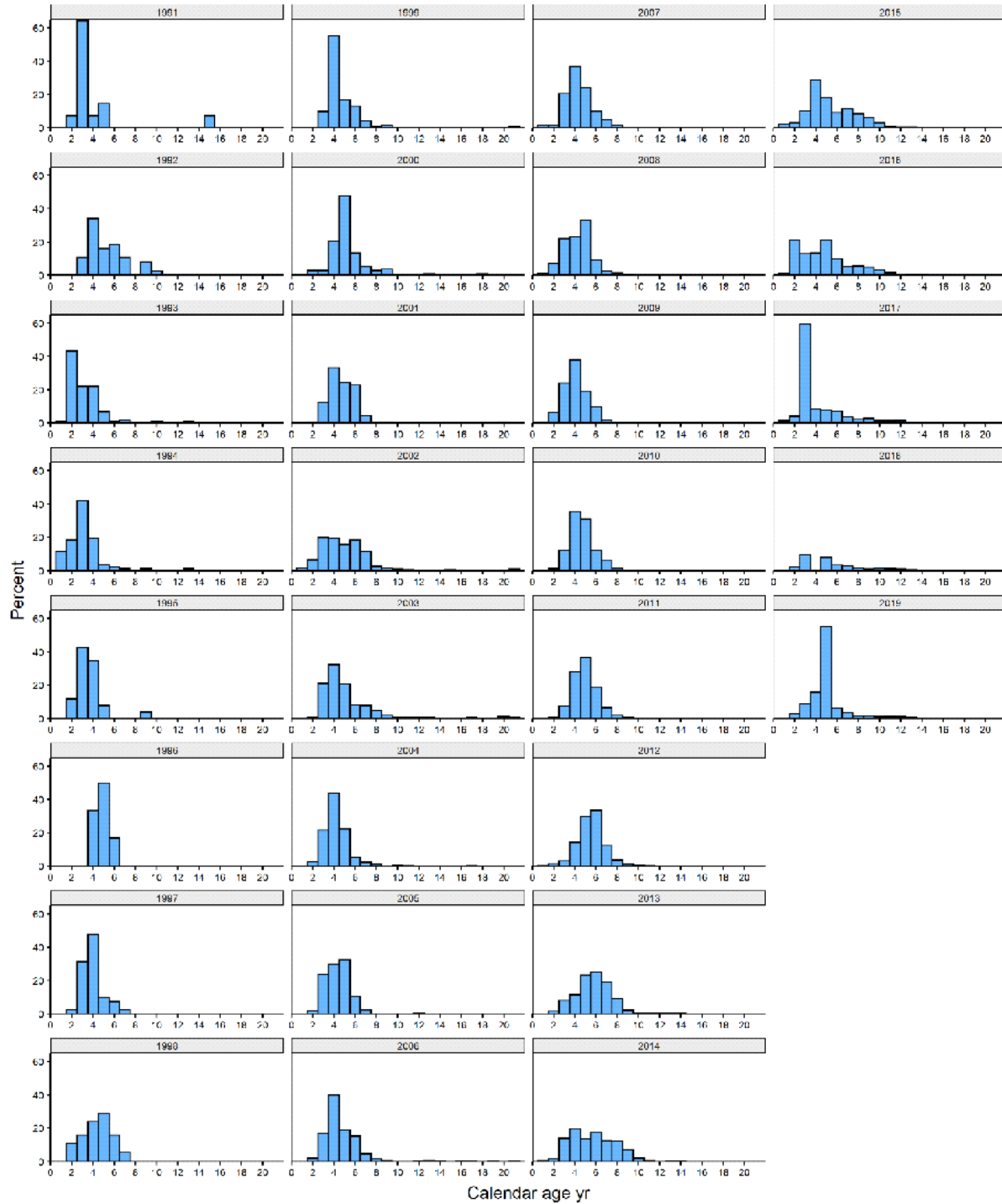




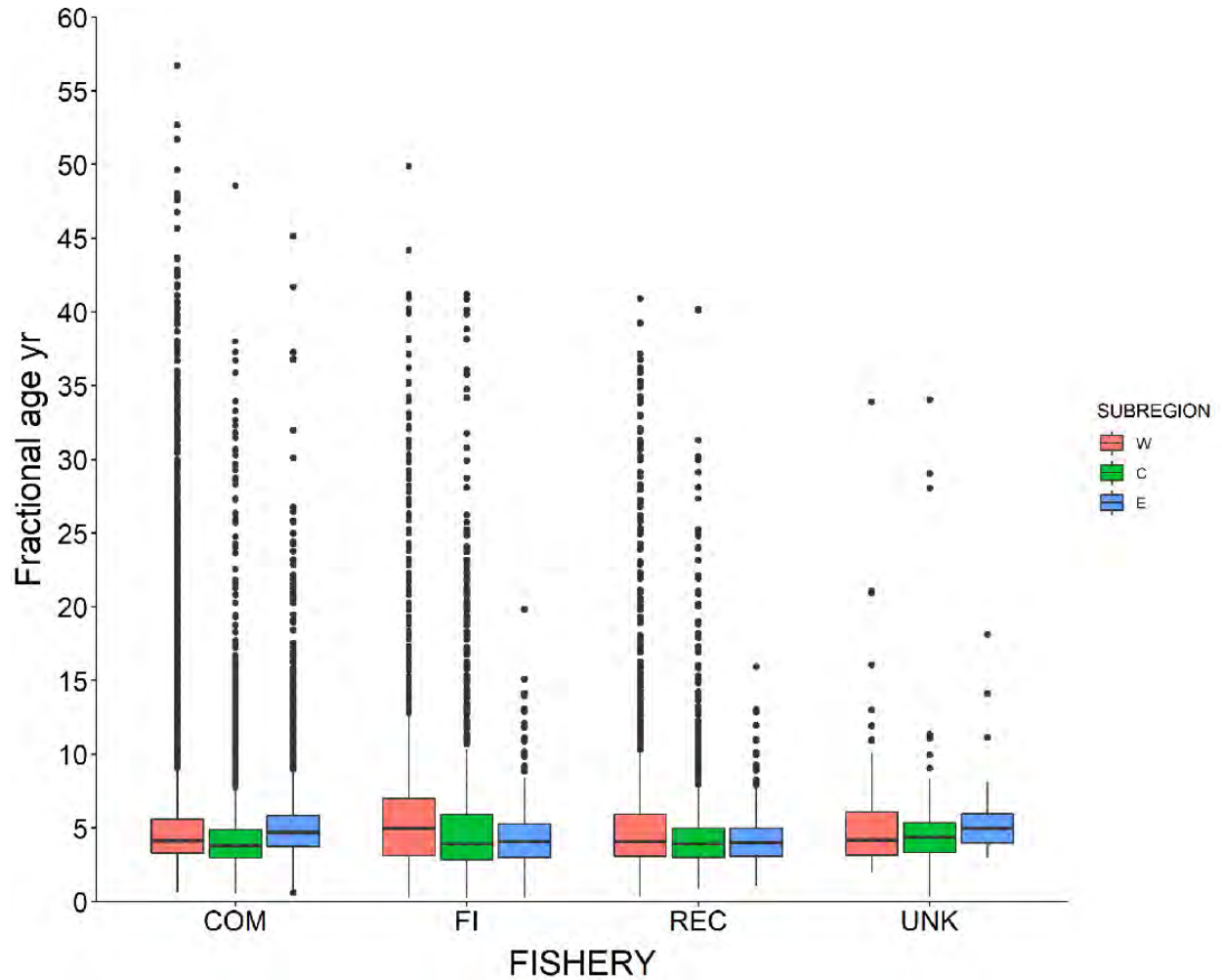
**Figure 6.** Frequency (%) histograms of calendar age (0 to 20 yrs) for red snapper age samples collected from the Central subregion Gulf of Mexico in 1980 and from 1991 to 2019. Bin increments are equal to 1 yr. Years with < 5 observations are not shown.



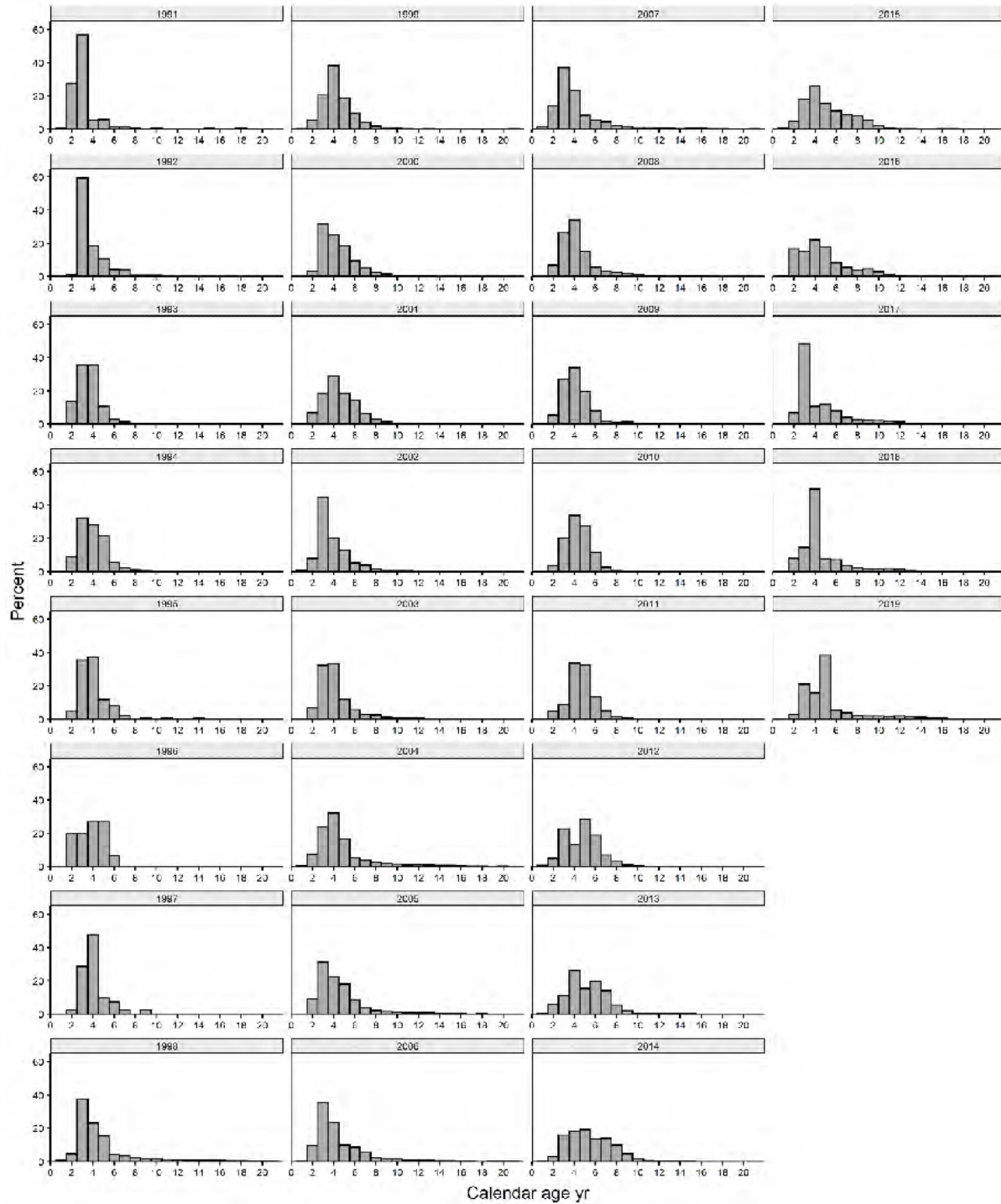
**Figure 7.** Frequency (%) histograms of calendar age (0 to 20 yrs) for red snapper age samples collected from the East subregion Gulf of Mexico from 1991 to 2019. Bin increments are equal to 1 yr. Years with <5 observations are not shown.



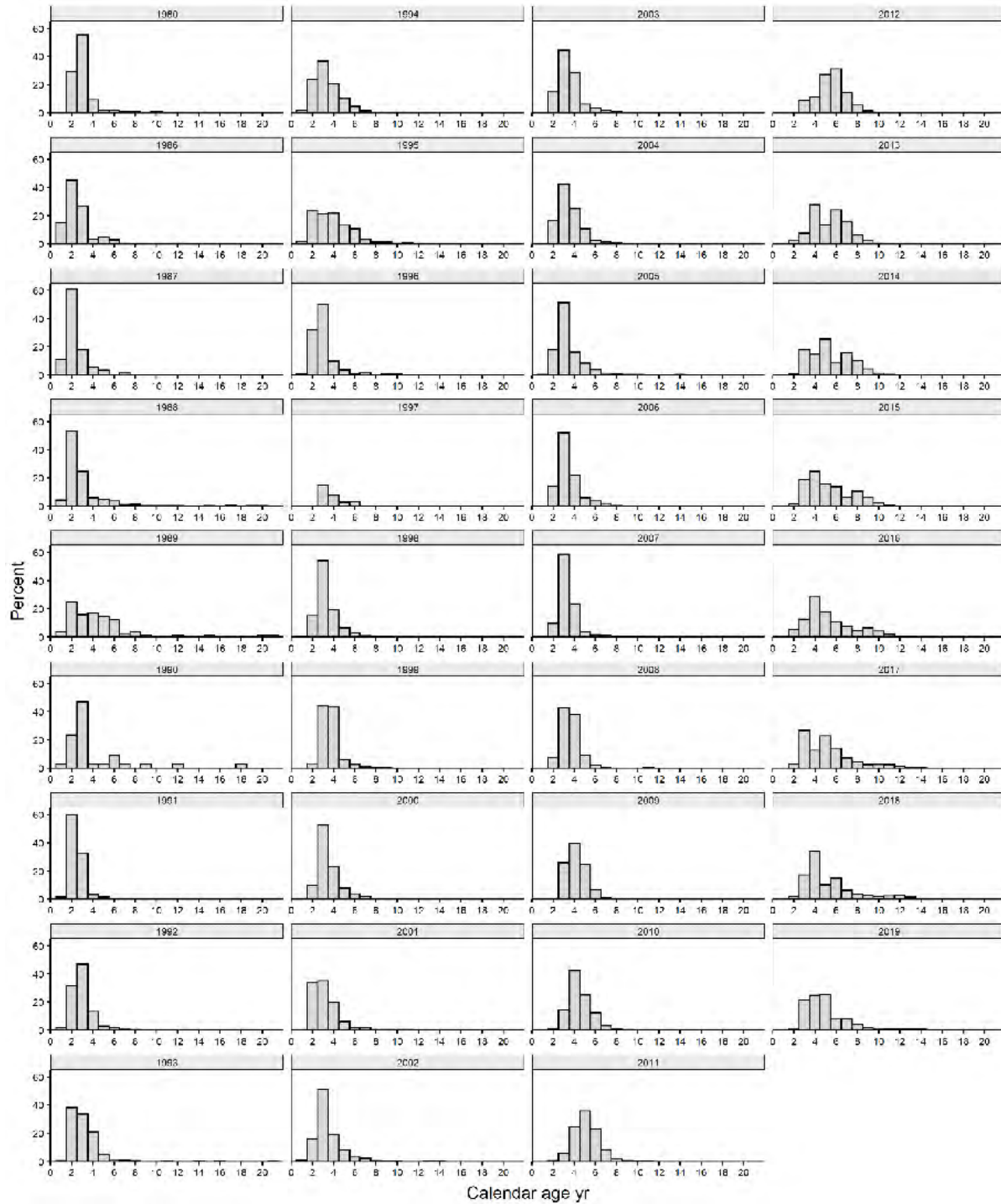
**Figure 8.** Boxplots of fractional age (yr) by subregion (West, Central, or East) and fishery (commercial, fishery independent, recreational, or unknown) for red snapper age samples collected in the Gulf of Mexico in 1980 and from 1986 to 2019. Upper and lower hinges indicate the first and third quartiles and whiskers extend to 1.5\*IQR. Outliers are indicated by filled circles.



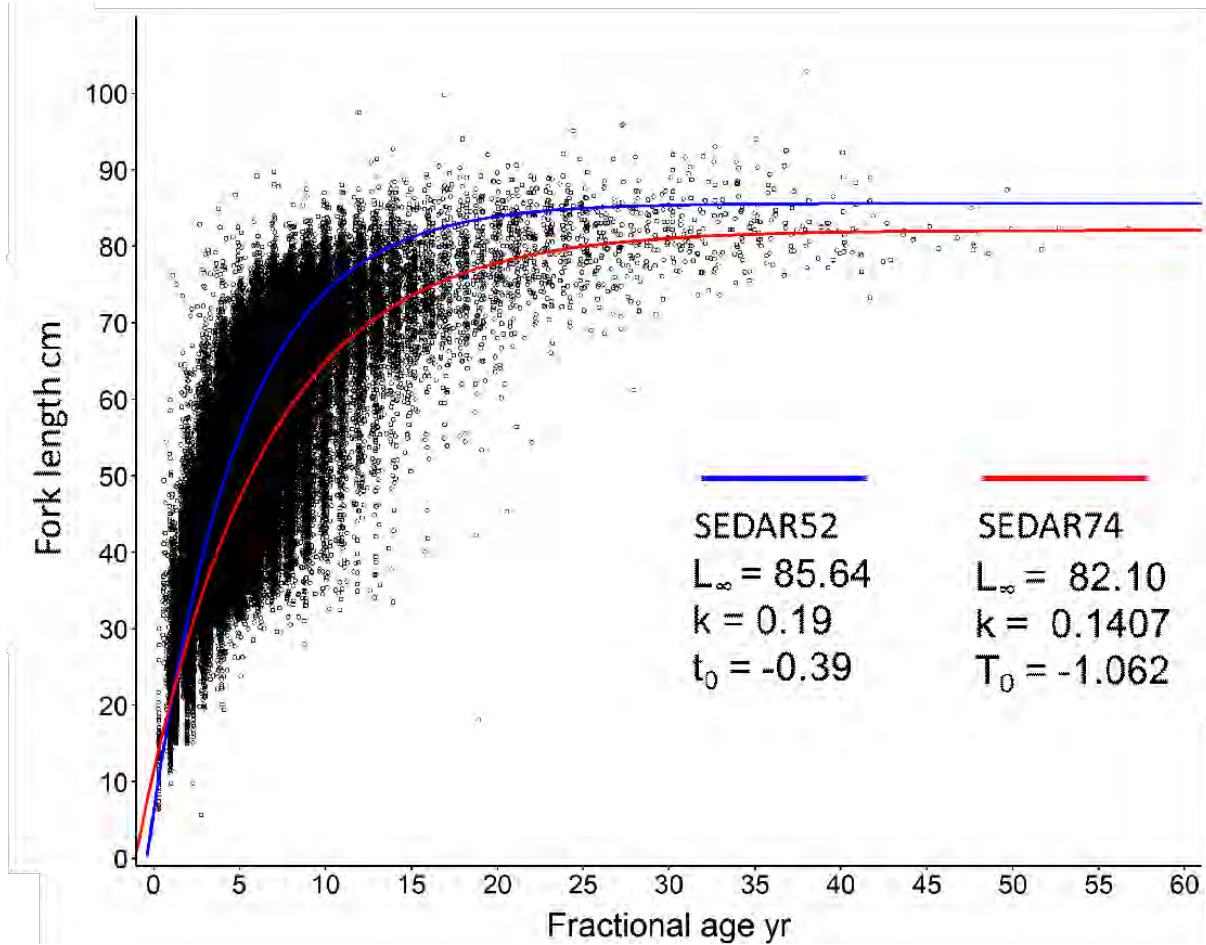
**Figure 9.** Frequency (%) histograms of calendar age (yr) for red snapper age samples collected from the commercial fishery in Gulf of Mexico from 1991 to 2019. Bin increments are equal to 1 yr. Years with <5 observations are not shown.



**Figure 10.** Frequency (%) histograms of calendar age (yr) for red snapper age samples collected from the recreational fishery in Gulf of Mexico in 1980 and from 1986 to 2019. Bin increments are equal to 1 yr.

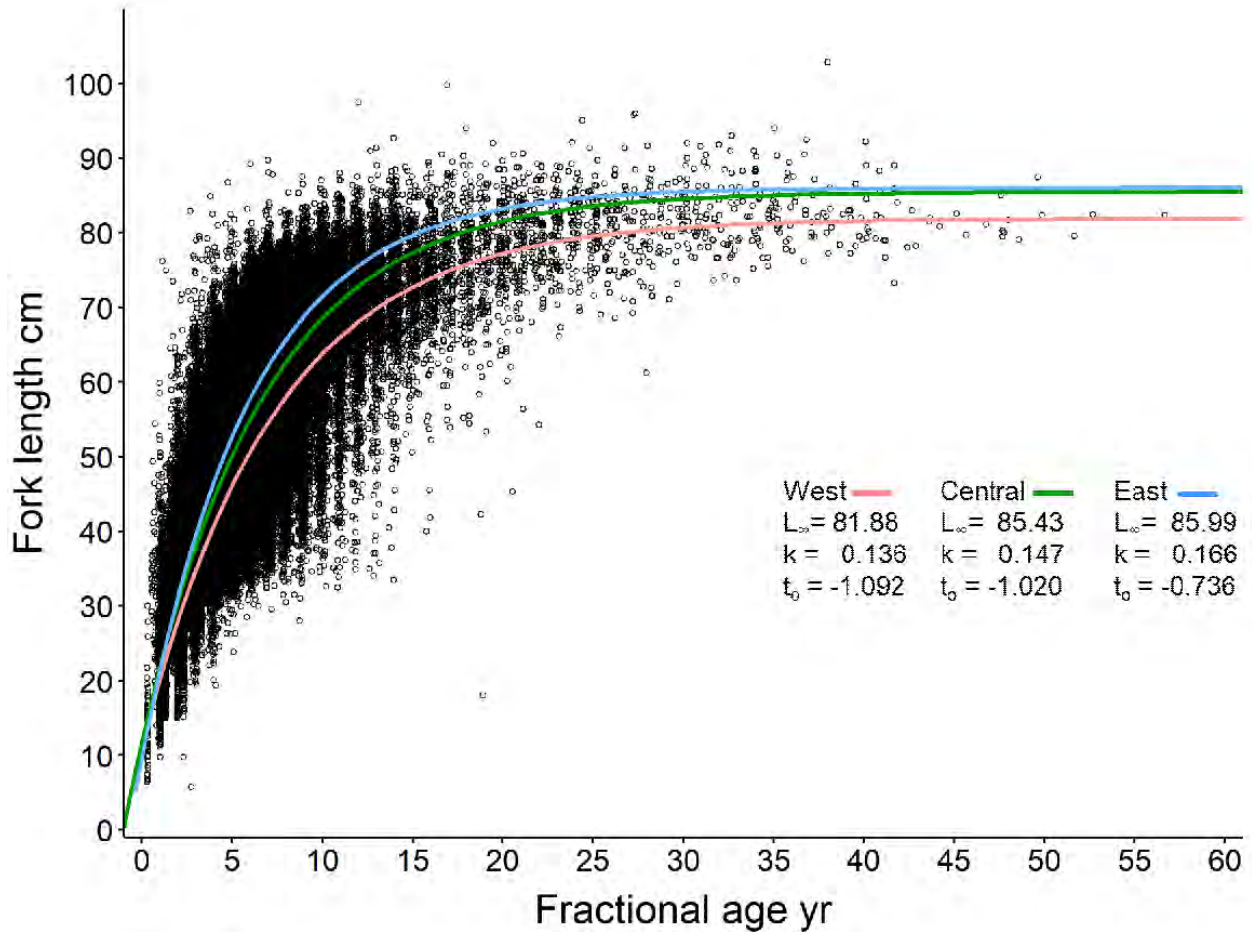


**Figure 11.** Scatter plot of fractional age (yr) versus final fork length (cm) for red snapper age samples collected in 1980 and from 1986 to 2019 from the Gulf of Mexico. Lines indicate best fit parameters from size-modified von Bertalanffy growth models (Diaz et al. 2004). Parameter values are listed in Table 3.

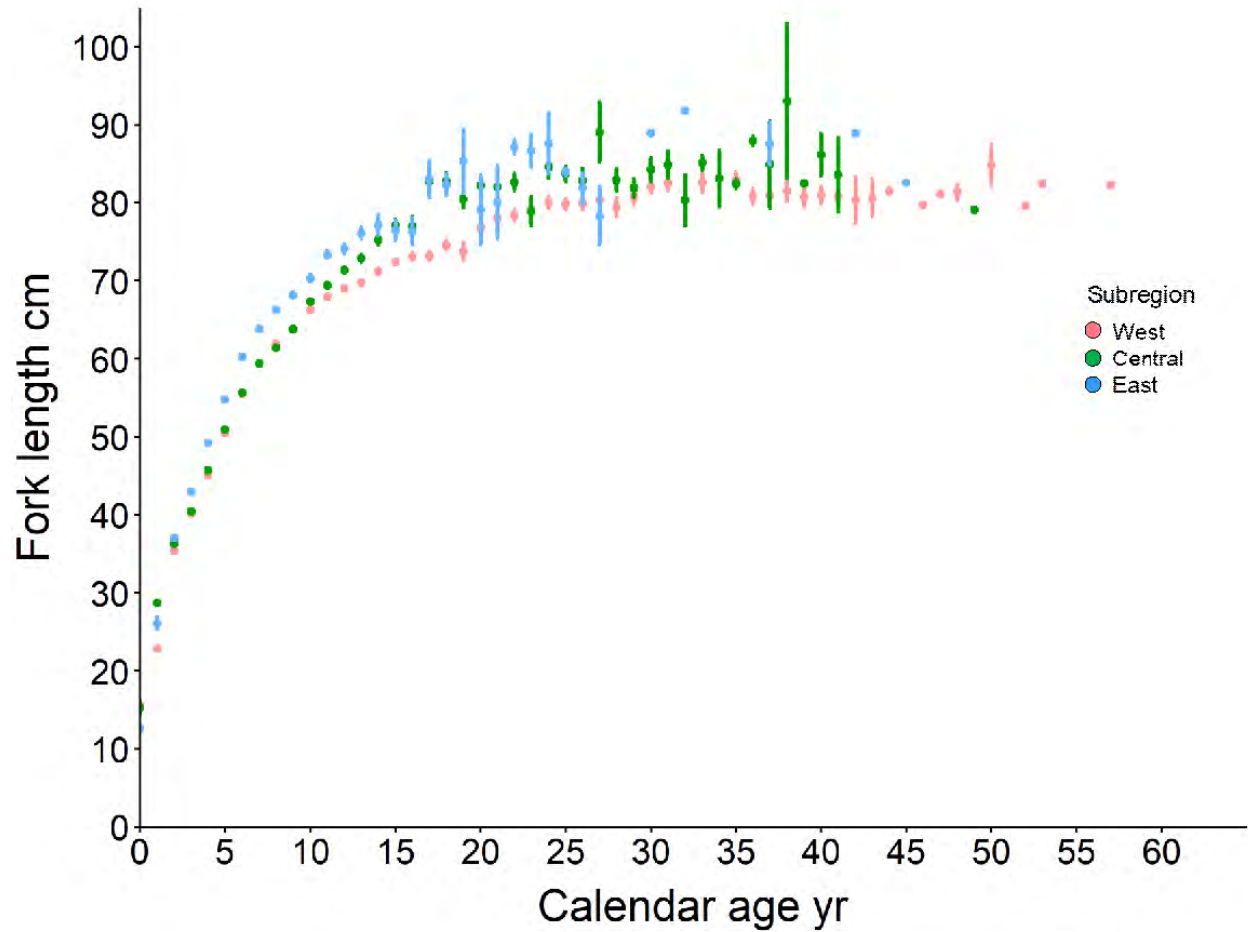




**Figure 12.** Scatter plot of fractional age (yr) versus fork length (cm) for red snapper age samples collected in 1980 and from 1986 to 2019 from the West, Central, or East subregion of the Gulf of Mexico. Lines indicate best fit parameters from size-modified von Bertalanffy growth models (Diaz et al. 2004) with inverse weighting of age data. Parameter values are shown on the plot and listed in Table 4.

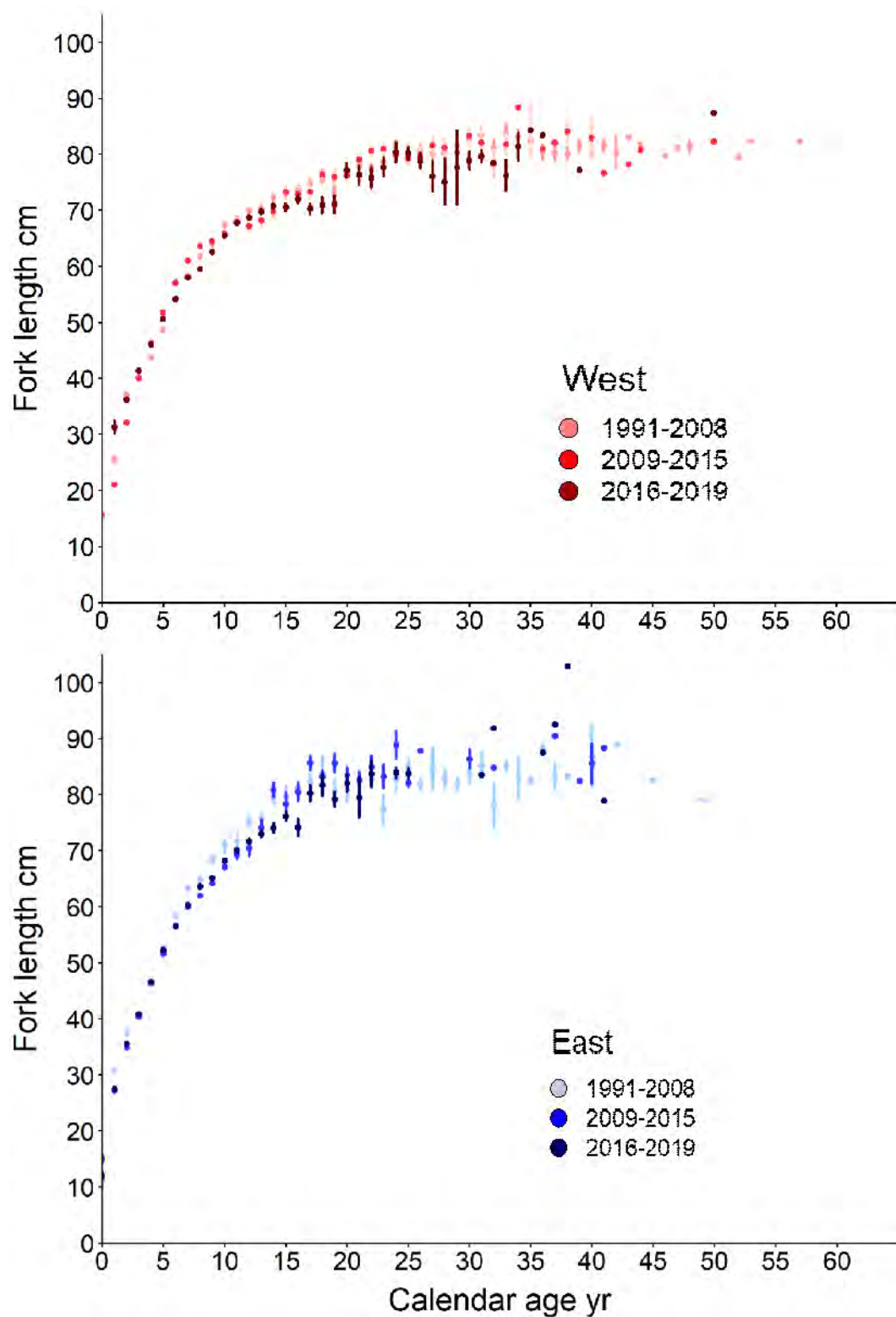


**Figure 13.** Mean size (FL, cm) at age (calendar, yr) of red snapper by subregion (West, Central, or East) for age samples collected in 1980 and from 1986 to 2019 from the Gulf of Mexico. Error bars indicate 95% CIs.

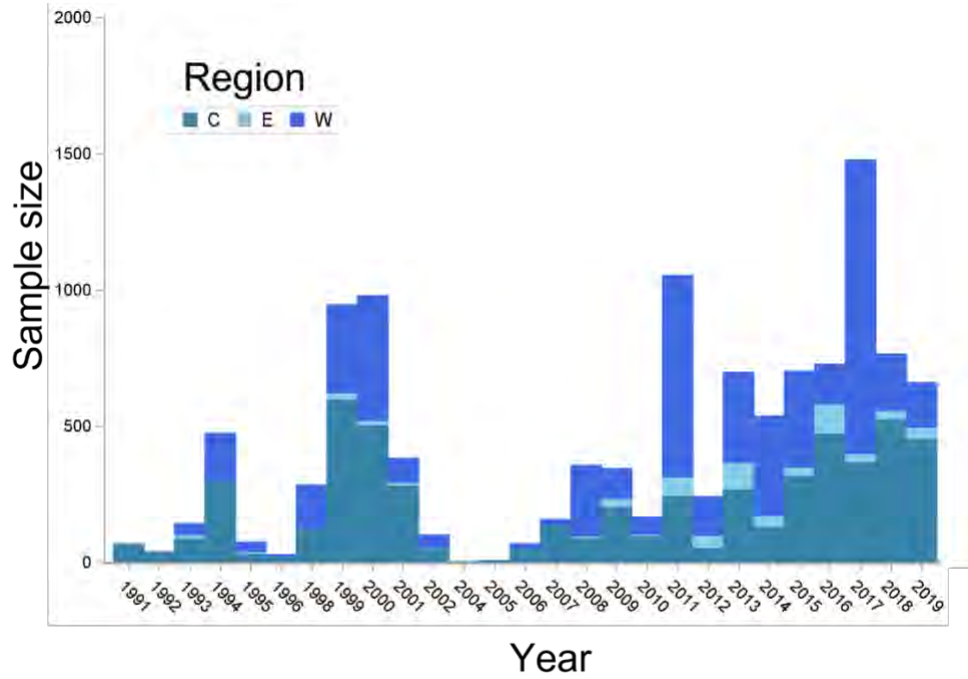




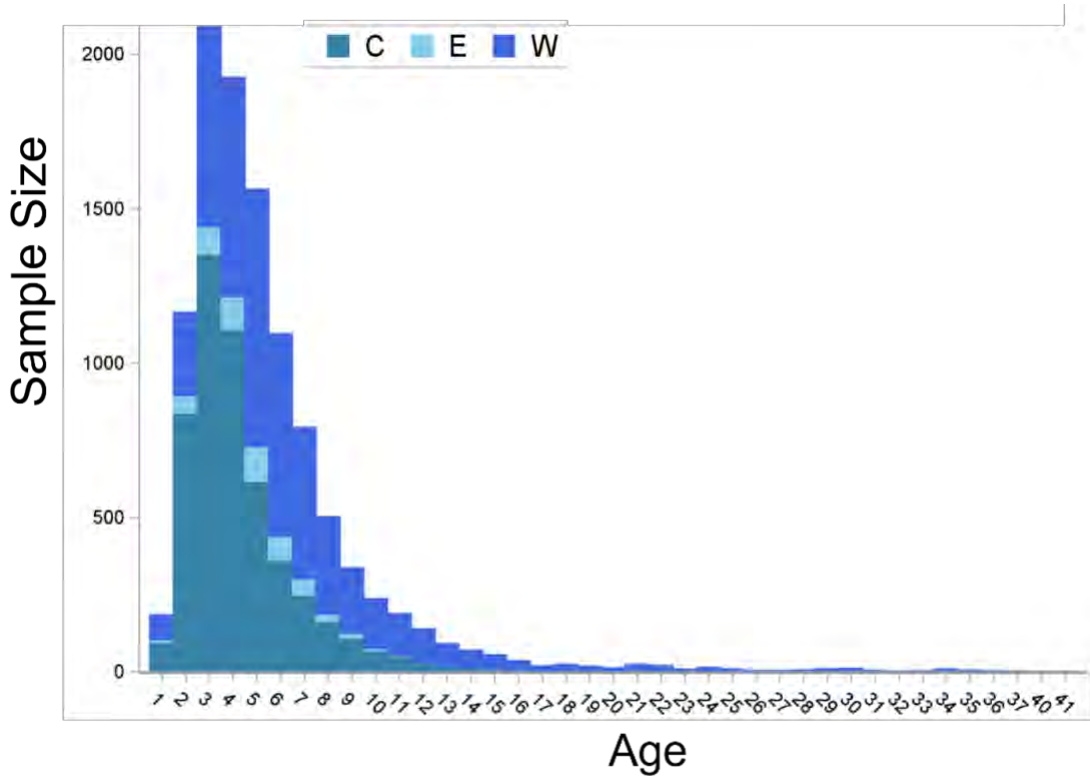
**Figure 14.** Mean size (FL, cm) at age (calendar, yr) of red snapper age samples collected from each time stanza from the West or East (combining Central and East) subregion of the Gulf of Mexico. Error bars are 95% CI.



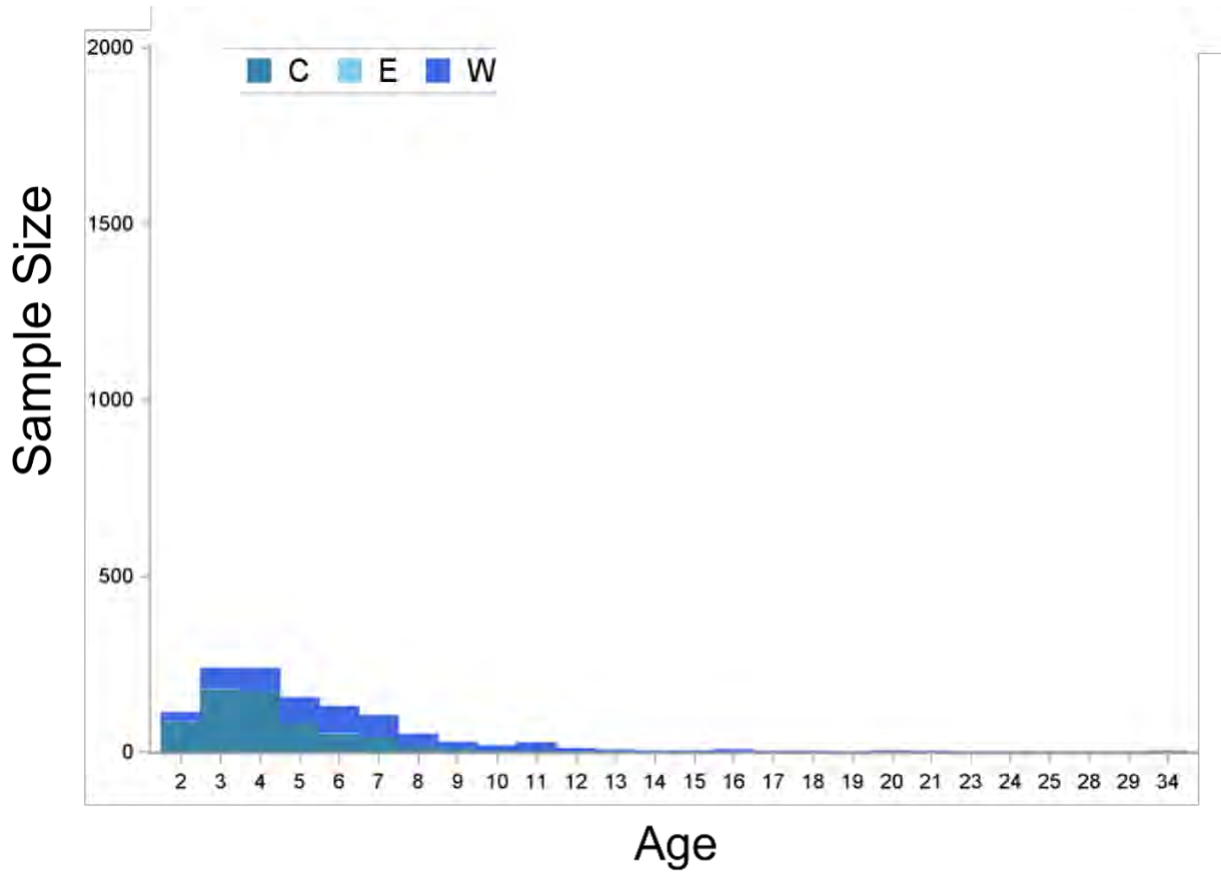
**Figure 15.** Samples sizes of reproductive data varied by year and area. Most samples came from the West (W) or the central (C) areas, with very few samples from the East (E).



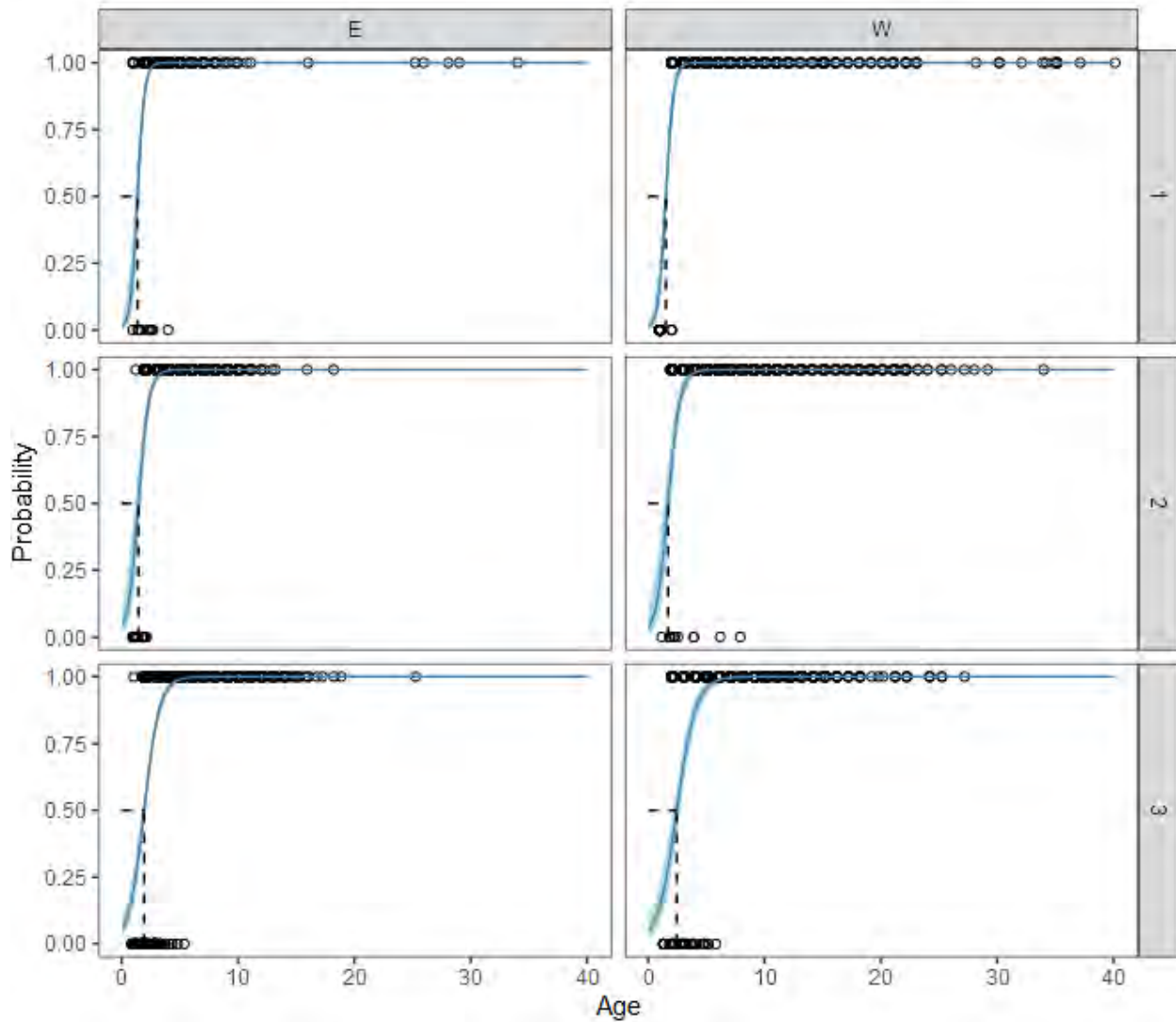
**Figure 16.** Reproductive sample size varied with age, with very few samples for fish older than age 15 y in any region. c-central; e-east; w-west.



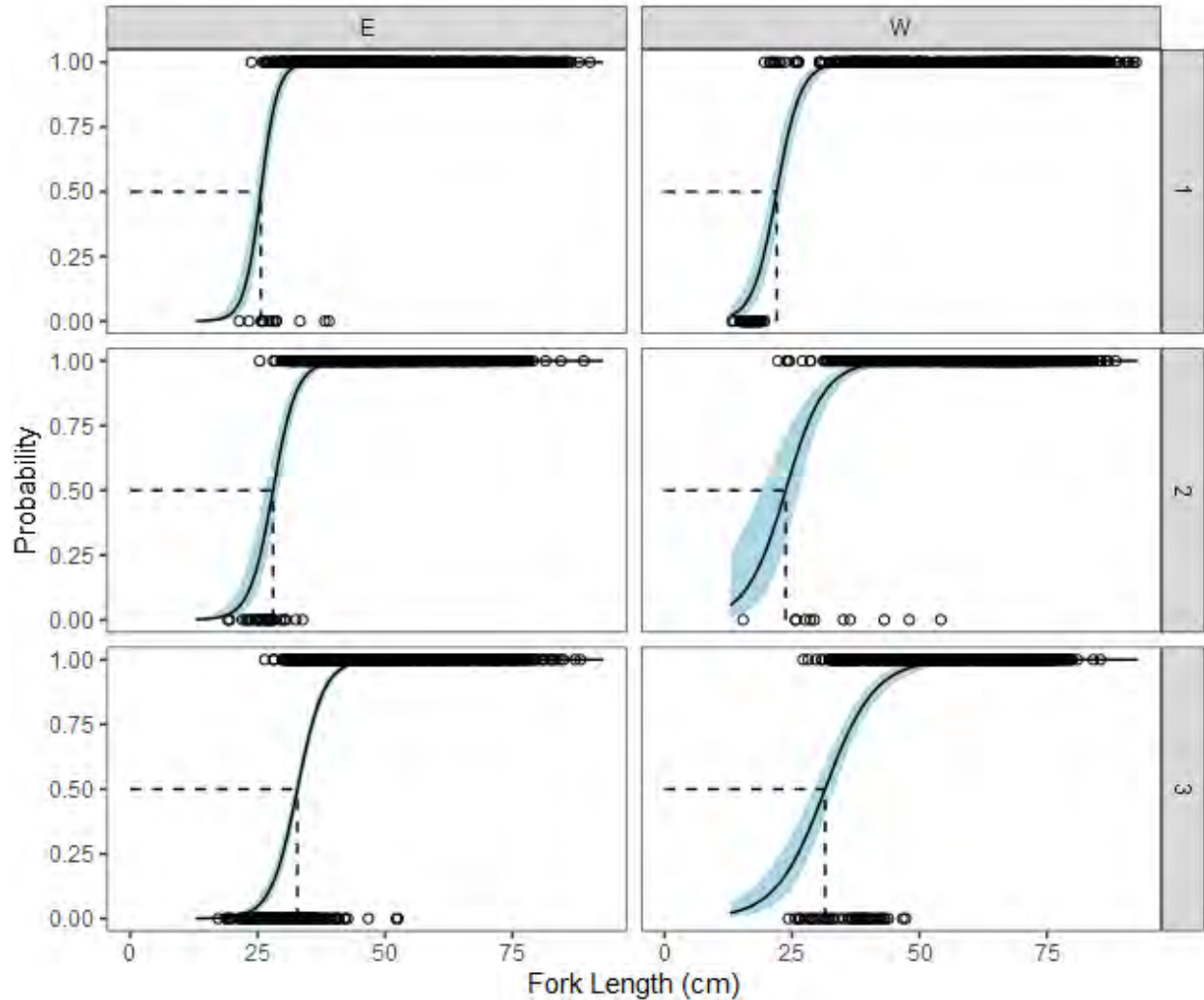
**Figure 17.** Of the reproductive samples, a much smaller sub-sample had batch fecundity estimates. These were mainly for fish age 10 y or younger, and few samples were from the east (E) compared to the central (C) or west (W) regions.



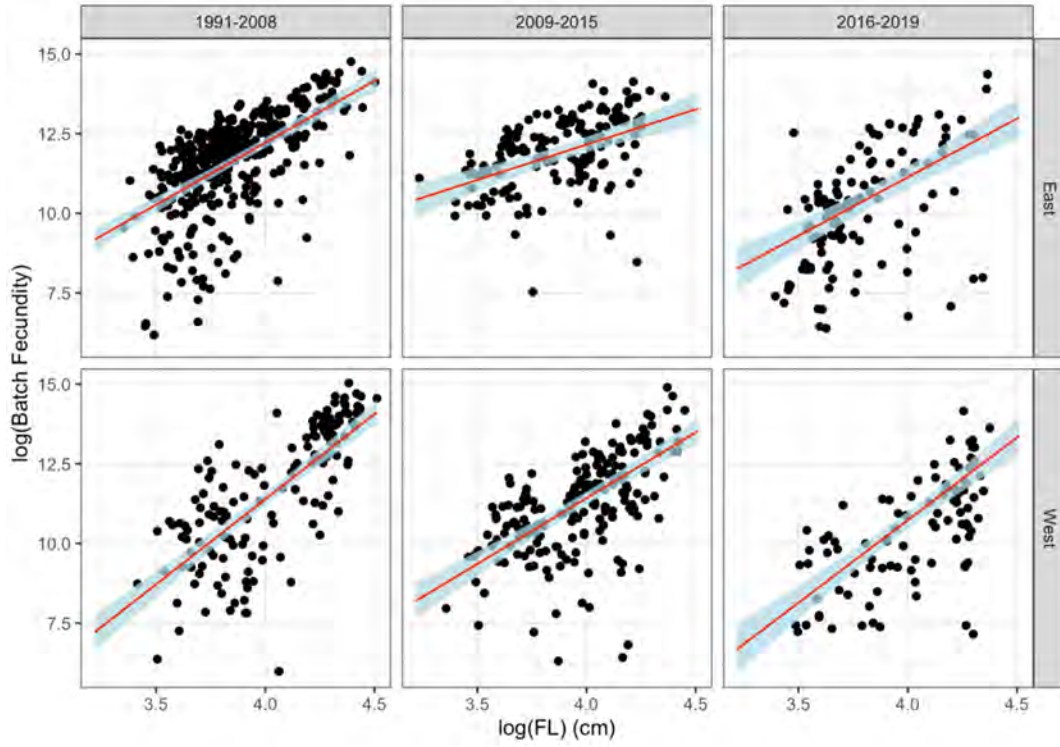
**Figure 18.** Observed and predicted age at maturity for eastern (E) and western (W) populations from a logistic binomial regression that estimated period-and-region-specific slopes and intercepts in a Bayesian modeling framework. The blue shaded area represents the upper and lower 2.5% quantiles from the posterior distribution of parameter estimates. Period 1– overfished (1991-2008); 2– rapidly recovering (2009-2016); 3–stabilizing (2017-2019).



**Figure 19.** Observed and predicted size at maturity results for eastern (E) and western (W) populations from a logistic binomial regression that estimated period-and-region-specific slopes and intercepts in a Bayesian modeling framework. These models used data collected from throughout the year but only immature and spawning reproductive phases. The blue shaded area represents the upper and lower 2.5% quantiles from the posterior distribution of parameter estimates. Period 1– overfished (1991-2008); 2– rapidly recovering (2009-2016); 3–stabilizing (2017-2019).

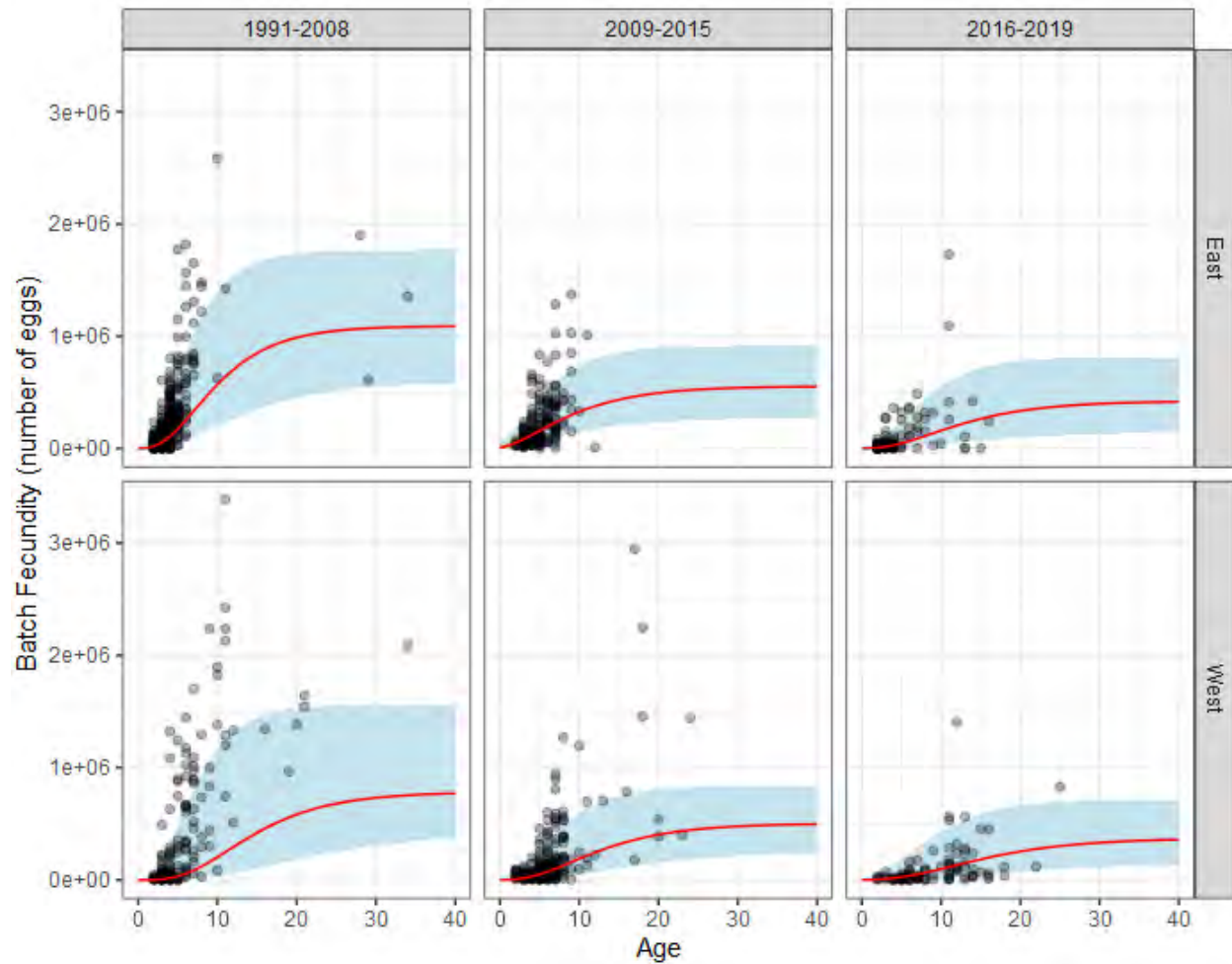


**Figure 20.** Observed (black points) and predicted (red lines) batch fecundity model fits by region and period of log-transformed batch fecundity to log-transformed fork length. The shaded blue areas are the 2.5% and 97.5% quantiles of predicted values from the posterior draws.

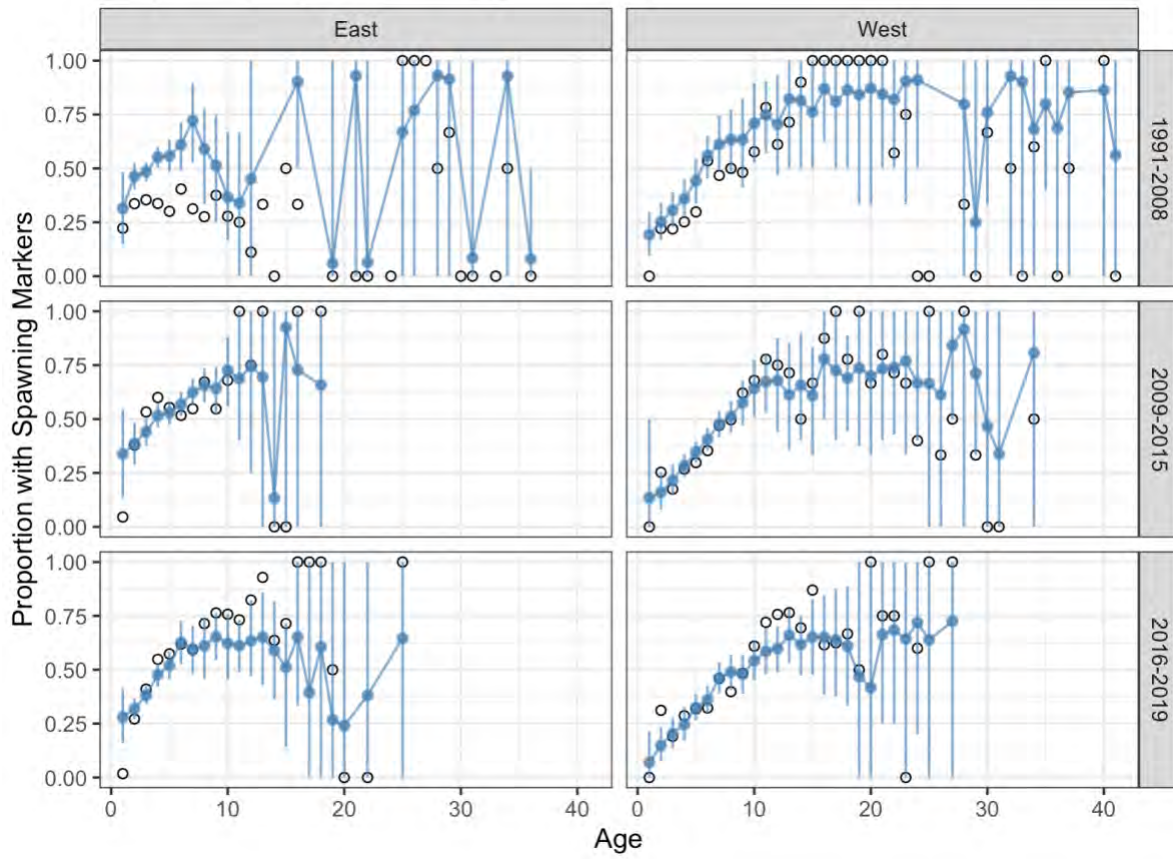




**Figure 21.** Observed (black points) and predicted (red lines) batch fecundity model fits by region and period to back-transformed batch fecundity (BF) and age. Period-and-region-specific von Bertalanffy growth parameters were used to obtain BF at age from BF at length. Red Snapper exhibit high variation of length at age. To reflect the uncertainty due to that variation, VB growth models were fitted to the 1<sup>st</sup> and 99<sup>th</sup> quantile of fork length at age and used to predict BF at those lower and upper ranges of length at age; these are reflected in the blue shaded area. Observed points are drawn transparently to better illustrate that the majority of observations occurred at young ages and low BF values which the model is fitting fairly well in all cases.

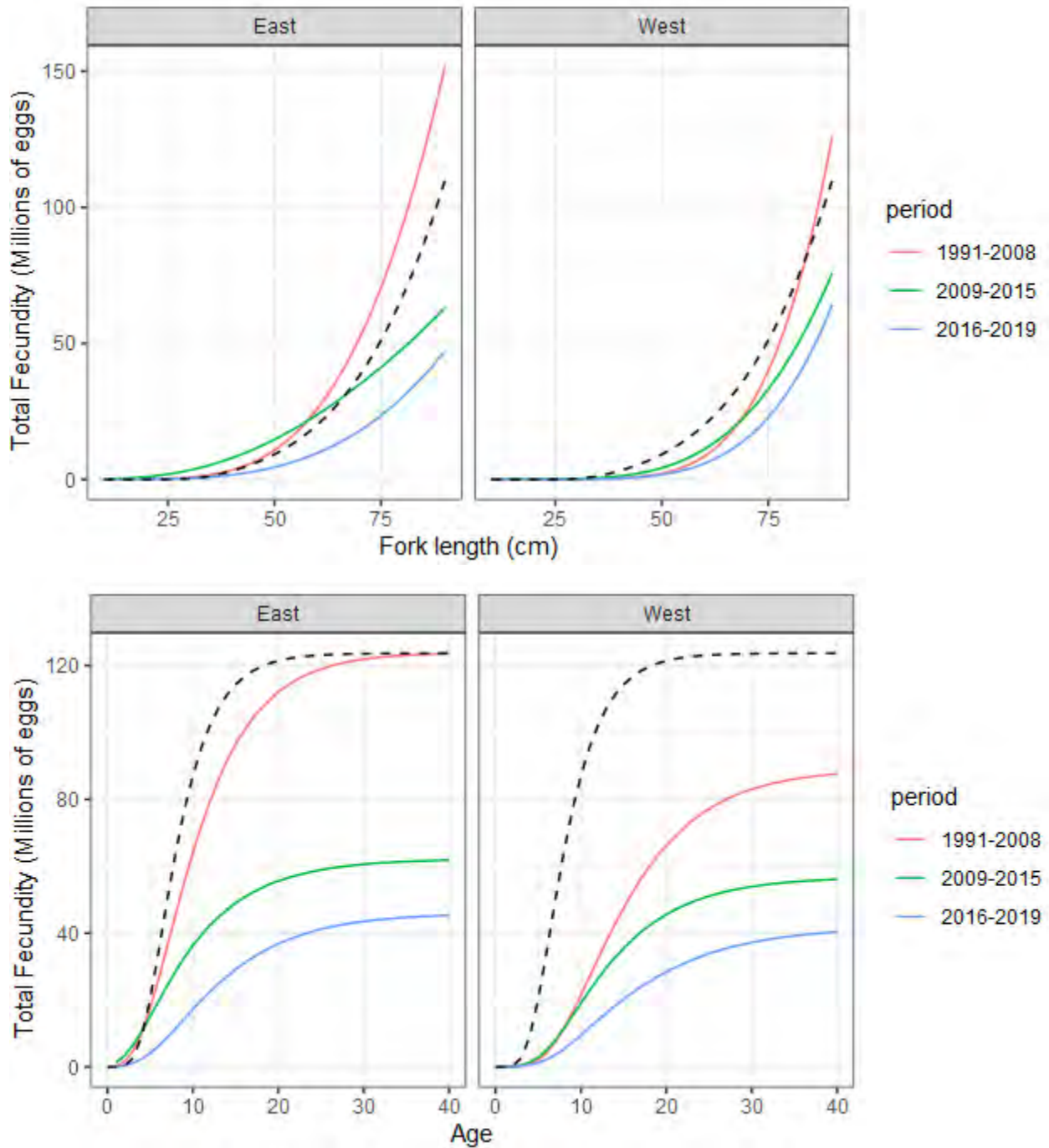


**Figure 22.** Observed (open circles) and estimated (closed circles) proportion with spawning markers by age. Closed circles represent mean values from posterior draws, and vertical lines indicate the 95<sup>th</sup> quantile of estimated values.

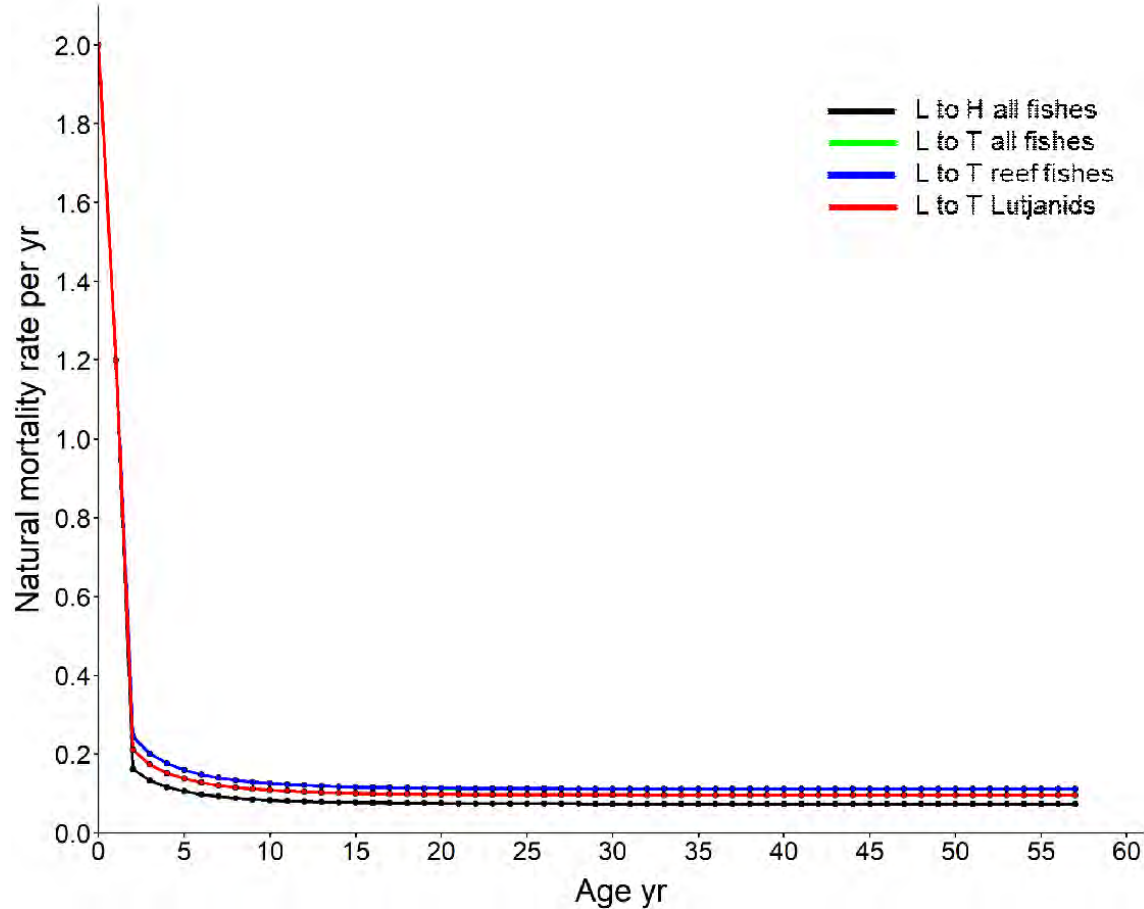




**Figure 23.** Estimated annual fecundity at length (top panels) and age (bottom panels), obtained by combining results from the batch fecundity and spawning fraction models. For comparison, the annual fecundity calculated by Porch et al. (2015) is shown as dashed black lines (note: the 2015 fecundity at length relationship was for total length rather than fork length and spawning frequency was based on data from the Congressional supplemental Red Snapper survey conducted in 2011 (n=1,002)).



**Figure 24.** Age-specific natural mortality estimates for Gulf of Mexico red snapper. Lorenzen (L) natural mortality curves are shown scaled to the average natural mortality rate  $\text{yr}^{-1}$  based on longevity from Hoenig (H) or Then (T) for all fishes, reef fishes, or Lutjanids. Ages 0 and 1 were assigned fixed values of 2.0 and 1.2  $\text{yr}^{-1}$ , respectively in all cases. Note that age-specific estimates for L to T reef fishes (blue) visually overlap estimates for L to T all fishes (green).



### 3 COMMERCIAL FISHERY STATISTICS

#### 3.1 OVERVIEW

Commercial landings of Red Snapper for the Gulf of Mexico were compiled from the Accumulated Landings System (ALS), a continuous commercial landings database of that began in the 1962. It is being maintained by the NOAA Fisheries’ Southeast Fisheries Science Center (SEFSC) in Miami, Florida (Gloeckner 2014, Poffenberger 2004) and provided the landings from 1962 to 2020 for this assessment.

Historical landings of Red Snapper in the Gulf of Mexico starting in 1872 had been previously reported by Porch (2004) and were also used in reconstructing the time series up to 1962.

Starting in 1990, gear and area information from the Coastal Fisheries logbook Program (CFLP) were used to assign gear and area to the landing as has been the case since decision was made in the SEDAR 7 assessment.

When water body information was not available, port of landing was used to assign area of catch (also a SEDAR 7 decision) and ALS Florida (General) Canvass data were used to assign gear and area to FL landings prior to Florida's Trip Ticket Program (FL\_TTP) in 1985 (Donaldson 2004).

Starting in 2007, an Individual Fishing Quota (IFQ) Program (Stephenson 2012) also known as Individually Transferable Quota (ITQ) was initiated for Red Snapper in the Gulf of Mexico and is managed by NOAA Fisheries' Southeast Regional Office (SERO). The IFQ landings were deemed the most accurate and are used to reapportion ALS landings data across all strata.

Discards were estimated for vertical line and bottom longline fleets by zone/subregion/stock, i.e. West, Central and East, using the discard information from the Reef Fish Observer Program (Sarine et al 2022a) and the effort information from the coastal logbook program (CFLP).

Length frequency distributions were constructed for Red Snapper in the years 1984-2019 using available length data from TIP database. Length frequencies were provided by year, for vertical line and bottom longline fleets, Handline+/Vertical Line+ (VL+) and long Line (LL) by zone/subregion/stock, i.e. West, Central and East.

### 3.1.1 Commercial Workgroup Participants

Below are the workgroup participant of the commercial workgroup and their affiliations:

Sydney Alhale	University of Miami/CIMAS
Donna Bellais	Gulf States Marine Fisheries Commission (GMFMC)
Buddy Guindon	Commercial Fisherman
Stephanie Martinez Rivera	NMFS Miami
Kevin McCarthy	NMFS Miami (Group Co-lead)
Paul Mickle	North Gulf Institute/Mississippi State University
Refik Orhun	NMFS Miami (Group Co-lead)
Steve Smith	University of Miami/CIMAS
Molly Stevens	NMFS Miami
David Walker	Gulf States Marine Fisheries Commission (GMFMC)
Wayne Werner	Commercial Fisherman

### 3.1.2 Issues Discussed at the Data Workshop

Issues discussed at the workshop in terms of commercial landings included historical landings, time lines regarding

- Uncertainties and CV's of commercial landing over whole

In addition, taking the proportioning the commercial landing into the

- New three subregions back in time prior to 1962 into historical landings and
- Reapportioning of landings by subregions between 1883 and 1909
- Shrimp Bycatch, reapportioning of bycatch between Central and East
- Reef fish observer data to inform discard size composition
- Gear selectivity using kept and discarded size data from reef fish observer program

### 3.2 REVIEW OF WORKING AND REFERENCE PAPERS

The workgroup considered data and analyses presented from these data workshop working papers:

**SEDAR4-DW-29:** This document describes SEFSC's Coastal Fisheries Logbook Program.

**SEDAR7-DW-23:** This document the commercial landings of Red Snapper including a description of the ALS.

**SEDAR7-AW-29:** This document describes the historical landings 1872-1962.

**SEDAR-PW6-RD-57.** This document describes the commercial landing programs in the Southeast and the ALS Database.

**SEDAR32-DW-11.** This document describes the calculated commercial discards of Blueline Tilefish.

**SEDAR41-DW-36.** This document describes the calculated commercial discards of Red Snapper.

**SEDAR74-DW-02:** This document provides Reef Fish Observer Program (TIP) metadata.

**SEDAR74-DW-03:** This document provides Coastal Logbook Fisheries Program (CLFP) metadata.

**SEDAR74-DW-15:** This document describes the length and age compositions of commercial (and recreational) landings.

**SEDAR74-DW-19:** This document describes the CPUE expansion estimation of commercial discards using observer data from 2007-2019.

**SEDAR74-DW-22:** This document describes the commercial landings from 1964 to 2020.

**SEDAR74-DW-37:** This document describes the commercial discards lengths from 1964 to 2020.

### 3.3 COMMERCIAL LANDINGS

The SEDAR 74 Gulf of Mexico Red Snapper was research track assessment and therefore preceded by a SEDAR 74 Stock ID Workshop (<http://sedarweb.org/sedar-74-gulf-mexico-red-snapper-stock-id-process>). During the SEDAR 74 Stock ID process, the previous definition of a western and eastern Red Snapper stock units adopted by SEDAR 7 in 2004 was changed after the Stock ID Workshop Panels decisions to a three-stock unit definition of a Western, Central and Eastern stock.

The Map in Figure 3.1 shows the Gulf of Mexico Fisheries Management Council region and the NMFS statistical areas 1-21 stretching from the Florida Keys in the East to the US border between Texas and Mexico in the West.

**Decision 1:** The Gulf of Mexico Red Snapper will be divided into three stock units, i.e. a Western, Central and Eastern stock. This subregion/zone will be defined by the NFMS Statistical areas 1-6 for the East, 7-12 for the Central, and the 13-21 for the Western stocks/subregions/zones (Figure 3.1).

Commercial landings for the Gulf of Mexico Red Snapper from 1872 - 2020 in whole pounds were aggregated by the three new subregions, West, Central and East. The decisions below provide detail on how the landings were compiled for red snapper.

**Decision 2:** Using the landings by subregions East and Central from 1964 to 1968, an average proportion based on those 5 years, was calculated, i.e. 57.3% of landings assigned to the Central and 43.7% of landings assigned to the “new” East. This proportion of landings was applied back in time to the landings of the historical East from 1910 to 1961.

In SEDAR7, historical landings of red snapper were constructed from 1880-1962 using various data sources. Further detail can be found in SEDAR7-AW22 (Porch et. al 2004).

Landings data were by port, but were assigned to region based upon several historical references. All landings prior to 1980 are grouped into Handline+/Vertical Line+ as the use of Long Line gear did not start for Red Snapper until 1980.

**Decision 3:** Based on information from Porch (2004), landings by subregions from 1872-1909 were reapportioned based on these principles.

- Prior to 1880 all landings were assigned to the Central.
- In 1880, the fishery expanded to the West.
- In 1883, the fishery expanded to the East (and South on FL peninsula).
- Landings to the Central and East 1883 to 1909 were apportioned using linear interpolation to match 1910 landings estimated for the Central and the East.

In SEDAR 7, historical landings of red snapper were constructed from 1880-1962 using various data sources. Landings data were by port, but were assigned to region based upon several historical references. Further detail can be found in SEDAR7-AW22 (Porch et. al 2004). A table of the all landing by region and gear from 1872 to 2020 can be found in Table 3.1 and Figure 3.3.1

### 3.3.1 Data Source

Historical commercial landings collected prior to 1962 (Porch 2004) are housed in a database in the National Marine Fisheries Service's Office of Science and Technology (S&T). Commercial landings for the modern time period (1962 to present) are maintained in the Accumulated Landings System (ALS) at the Southeast Fisheries Science Center (SEFSC). Data collected prior to the advent of the trip ticket programs in each state are generally referred to as the NMFS General Canvass data (Gloeckner 2014, Poffenberger 2004). General Canvass data were collected by port agents stationed in each county. The port agents would collect total landings from dealers and use local knowledge to proportion the landings into the proper fishing areas and gears. The ALS uses trip level data after the advent of trip ticket programs in each state.

Implementation of the individual state trip ticket programs started with Florida (FL\_TTP) coming into full implementation in 1986, after which the FL\_TTP provided the West Florida commercial landing to the ALS, where the landings data are kept as monthly summaries of the landings. In the Gulf of Mexico, trip ticket data were available directly from the state trip ticket program or through the Gulf of Mexico Fisheries Information Network (GulfFIN) housed at the Gulf States Marine Fisheries Commission (GSMFC). The implementation of other Non-FL state Trip Ticket Programs varied by state and is shown Table 3.3.

### 3.3.2 Boundaries

The red snapper has been managed as separate Gulf of Mexico and South Atlantic stocks, where the stock boundary lays in fishing areas 1 and 2 off the southern tip of Florida. The Gulf of Mexico landings from areas 1 and 2 are taken from water bodies north of highway U.S. 1 in the Florida Keys and north of the boundary line that extends from Key West to the Dry Tortugas. Waters west of the Dry Tortugas are considered to be the Gulf of Mexico. Gulf of Mexico landings are spatially distributed using the fishing areas 1 to 21, reaching from fishing area 1 in the Florida Keys, northwestern to fishing area 21 bordering Mexico (Figure 3.2).

### 3.3.3 Commercial Gears

In agreement with prior SEDARS, i.e. 7, 31 and 52, it was the workgroup's recommendation to then categorize landings into two gear groups: Handline+ (or Vertical Line+) and Long Line.

The list of gear codes included in each category can be found in a data workshop working paper SD74-DW-22 (Orhun 2022).

### 3.3.4 Landings in Numbers

Commercial landings of Gulf of Mexico Red Snapper were also estimated in numbers of fish based on average weight data from the TIP observer program. Weights of five-year time periods were averaged from 1984 to 2020 (except for the first time period, 1984-1990) and applied to the landings in whole pounds. Landings in numbers of fish from 1984 to 2020 are shown in Table 3.2 and Figure 3.3.2.

## 3.4 COMMERCIAL DISCARDS AND BYCATCH

The number of Red Snapper discarded from commercial fishing vessels was calculated using methods developed during SEDAR 32 (McCarthy 2015, 2013). Those methods have become the standard approach for commercial fishery discard calculation for species where observer reported data are insufficient for discard calculation. The commercial discard logbook data were used to estimate discards for the period 1995-2006. Discards were not estimated prior to 1995 because of a change in the minimum size of commercially landed Red Snapper. No discard data were available to inform the discard rate of Red Snapper prior to 1995. Reef fish observer data were used to estimate commercial discards beginning in 2007. Fishers have reported changes in fishing behavior due to the implementation of management through IFQs. Those behavioral changes likely affected discard rates. The first full year of the reef fish observer program was 2007, the same year that Red Snapper IFQ began, therefore using discard rates from the reef fish observer program to estimate discards prior to 2007 was not recommended.

### 3.4.1 Discards in Pre-IFQ Years

Red snapper discard rate was calculated using discards and effort data reported to the discard logbook program. A random selection of 20% of commercial fishers, by region (Gulf of Mexico, South Atlantic) and gear are required to report to the discard logbook program each year. Total effort for the commercial fleet by gear was available from the coastal logbook program. Those two data sources were used to estimate total discards from the commercial fleet.

Red Snapper discards were reported from to the discard logbook program in sufficient numbers of trips to estimate total discards from only vertical line (handline and electric/hydraulic reels) and bottom longline vessels. Data were also stratified by region as defined by the SEDAR 74 stock identification workshop panel and Red Snapper season (open/closed). After limiting the data set to those gears, data filtering followed the methods recommended during SEDARs 32 and 41 (SEDAR32-DW-11, SEDAR41-DW36). Data were filtered to exclude trips landing only mackerel because it was generally believed by the SEDAR 32 and 41 panels that for trips

targeting mackerel only, the likelihood of catching species other than mackerel was extremely low. To avoid removing mixed effort trips, however, only trips with 100% mackerel landings were excluded for the analytical data set.

A final data filter designed to address possible underreporting of commercial discards was included in this analysis following the recommendation of SEDARs 32 and 41. Fishers remain in reporting compliance by returning discard logbooks with reports of “no discards”. The percentage of discard reports returned with “no discards” from vertical line trips has increased from 7.5 to 11.8 percent during the period 2002-2006. Reports of no discards from bottom longline vessels varied among years from 5.9 (2006) to 22.4% (2005; all other years 12.7 – 16.4%). During the SEDAR32 data workshop the issue of possible underreporting of commercial discards was discussed at length. The working group recommended that data be filtered to remove records from vessels that never reported discards of any species during a year. The SEDAR 32 working group acknowledged that some commercial fishing trips may not have had discards of any species and discussed the likely maximum number of trips by a vessel without a report of discards. Following the SEDAR 32 and 41 commercial working groups’ recommendations, data from commercial vertical line vessels that reported more than four, two, or three (east, central, and west regions, respectively) trips without reporting discards of any species (the mean number of trips prior to the first trip with reported discards plus two standard deviations above that mean) were excluded. Similarly, data from bottom longline vessels with no discards reported for more than six (east region) or four (central and west regions) trips without reporting discards of any species were excluded.

Discard rates of vertical line vessels were calculated as the mean rate (discards per hook hour fished) within each region and gear over the years 2002-2006. Yearly total effort (vertical line: hook hours; bottom longline: hooks fished) of all trips by gear within each region for each year 1995-2006 was multiplied by the mean discard rate from the appropriate gear and region to calculate total discards of Red Snapper by commercial vertical line and bottom longline vessels. Discards in number of fish by gear and region are provided in Tables 3.4.1.1 (vertical line) and 3.4.1.2 (bottom longline).

Weights of commercial discards were not reported to the discard logbook data, however, discard mean weights were available from the reef fish observer data. Due to a minimum size change in 2008, only those reef fish observer program data from 2007 were appropriate to inform the conversion of estimated discards in number of fish to discards in weight. Mean weight of discards was available by gear and by those vessels with IFQ allocation (some fished were landed) and those vessels without IFQ allocation (all fish discarded). The mean weight of fish discarded from vessels with IFQ allocation was used as a proxy for the mean weight of fish discarded from vessels during Red Snapper open seasons prior to 2007. The mean weight of fish discarded from vessels without IFQ allocation was used as a proxy for the mean weight of fish discarded from vessels during Red Snapper closed seasons prior to 2007. Discard mean weights are provided in Table 3.4.1.3. Discards in weight (whole pounds) by gear, region, and Red



Snapper season (open/closed) are provided in Tables 3.4.1.4 (vertical line) and 3.4.1.5 (bottom longline).

**Decision 4:** Recommended the estimated discards for use in the assessment model(s) with a CV of 0.6. The recommended CV matches the highest CV calculated for discards estimated using the reef fish observer data. The work group recommended that magnitude of CV for the discards estimated using discard logbook data due to the low confidence in those self-reported data.

### 3.4.2 Discards during IFQ Years

The general approach for estimating discards for the commercial reef fish fleet in the Gulf of Mexico utilizes catch-per-unit-effort (CPUE) from the coastal Reef Fish Observer Program (RFOP) and total fishing effort from the Coastal Fisheries Logbook Program (CFLP) to estimate total catch.

For discard estimation, CPUE was computed for total discards, including fish released alive, released dead, released in unknown condition, and used for bait. The principal focus of this study was to apply recently developed discard estimation methods for Gulf of Mexico red grouper, gray triggerfish, and vermilion snapper to Gulf of Mexico Red Snapper. Discard estimation was conducted separately for two gears, vertical line (VL) and bottom longline (BLL). A verification step compared the annual total landed catch from logbook data with the estimated observer annual total landed catch. Once verified, Red Snapper annual total discards in weight and number were estimated for the observer data period 2007-2019, for each of the zones (East, Central, and West). Full details of the methodology applied to the Gulf of Mexico Red Snapper are described in a data workshop working paper (Martinez et al. 2022).

CPUE expansion estimates for annual discards in weight and number of GOM Red Snapper for 2007-2019 by subregion are provided in Table 3.4.2.1 for vertical line gear. For VL, the annual average of discards in weight accounted for about 11%, 12%, and 44% of the total catch for West, Central, and East, respectively (Fig. 3.4.2.1).

CPUE expansion estimates for annual discards in weight and numbers of GOM Red Snapper for 2007-2019 are provided in Table 3.4.2.2 for (bottom) longline gear (LL). For bottom LL, the average of discards to total catch was 61%, 118%, and 127%, for central, east, and west, respectively (Fig. 3.4.2.2).

### 3.4.3 Discards from the Shrimp Fishery

An investigative team from NOAA SEFSC's Fisheries Statistics Division is currently refining data processing and analysis procedures to improve accuracy of red snapper bycatch estimates from the shrimp trawl fishery. This research is anticipated to be completed and reviewed for producing revised shrimp trawl bycatch estimates for red snapper for the 2023 operational assessment. In the meantime, bycatch estimates from SEDAR 52 for statistical zones 1-12

(previous East subregion) were apportioned into the new Central (statistical zones 7-12) and East (statistical zones 1-6) subregions (Table 3.4.3). For 1985-2016, shrimp trawl effort was estimated for the new Central and East subregions (L. Coggins, NOAA SEFSC), and these were used to apportion bycatch estimates by subregion. For 1972-1984, the average proportion effort by subregion was computed for years 1985-1989 and then applied to the historical time-series of red snapper bycatch estimates.

### 3.5 COMMERCIAL EFFORT

Commercial logbooks for the period 1993-2019 were used to evaluate the number of trips landing red snapper for two principal gears, vertical lines and bottom longlines. Average annual trips were estimated by statistical zone for 4 time periods: (i) 1993-1999, (ii) 2000-2006, (iii) 2007-2013, and (iv) 2014-2019. The resulting maps are shown in Fig. 3.5.1 for vertical lines and in Fig. 3.5.2 for bottom longlines.

#### 3.5.1 Shrimp Trawl Effort

An investigative team from NOAA SEFSC's Fisheries Statistics Division is currently refining data processing and analysis procedures to improve accuracy of shrimp trawl effort in the Gulf of Mexico. This research is anticipated to be completed and reviewed for producing revised shrimp trawl effort estimates for the 2023 operational assessment. In the meantime, updated shrimp trawl effort estimates (L. Coggins, NOAA SEFSC) were used to produce a time-series for the period 1945-2019 for 3 subregions (Table 3.5). For 1985-2016, shrimp trawl effort was estimated for the West subregion (statzones 13-21) and new Central (statzones 7-12) and East (statzones 1-6) subregions. For 1960-1984, updated effort estimates were provided for the West subregion and the previous East (statzones 1-12) subregion. The updated effort for 1960-1970 was used in Clay Porch's SEDAR 52 procedure to estimate effort for 1945-1959 in the West and previous East subregions. The average proportion effort for the new Central (statzones 7-12) and East (statzones 1-6) subregions was computed for years 1985-1989, and then used to apportion effort accordingly from the previous East subregion (statzones 1-12) into the new Central and East subregions for the period 1945-1984.

### 3.6 BIOLOGICAL SAMPLING

Biological sample data for red snapper were obtained from the TIP database housed at NMFS-SEFSC (1984-2019) and the Gulf States Marine Fisheries Commission's Fisheries Information Network (GulfFIN, 2002-2019). Data were filtered to eliminate records that included a size or effort bias and non-random collection of length data.

#### 3.6.1 Length Distribution of Commercial Landings

Red Snapper length samples were reviewed for the years 1984-2019 using available TIP length data. Commercial landings nominal length frequency distributions were provided by year and fleet, which was defined as unique combinations of gear (Vertical Line, Longline) and stock (West, Central, East). Each fleet was analyzed at the finest spatial resolution possible by time period to ensure appropriate aggregation for the assessment model.

In the previous red snapper assessment, SEDAR52, the VL “eastern stock” length compositions were weighted by landings along the approximate boundary between the current Central and East stocks. Adding this additional stock boundary means that the nominal compositions are on a finer resolution and are appropriate to represent the landings from each of the three stocks. West and Central length compositions are approximately equal within their respective stocks, while the East stock may require weighting in the future, particularly if sampling effort diverges from landings disproportionately (Figure 3.6.XX1).

All LL fleets have minimal landings and sample sizes compared to VL. In the previous red snapper assessments, nominal compositions were provided for East and West stocks because there were insufficient samples to weight landings in the East. Due to these limitations, the Central LL fleet will have data gaps (Figure 3.6.XX2).

**Recommendations:** Provide nominal length compositions for each commercial fleet. If VL compositions continue to diverge, they may require weighting in future assessments.

### 3.6.2 *Size Frequency Data from Commercial Fisheries Observers*

Commercial discard lengths from observer data were provided for 2007-2019.

### 3.6.3 *Age Distribution*

Age samples are collected as part of the TIP sampling protocol for the vertical line and longline gears. The number of Red Snapper aged from the commercial fishery by year and stock is summarized in Table 3.6.XX1. The number of trips these ages were collected from are summarized in Table 3.6.XX2. The final commercial age composition inputs will be determined in the assessment phase.

## 3.7 COMMENTS ON ADEQUACY OF DATA FOR ASSESSMENT ANALYSES (KEVIN/STEVE)

Overall, the workgroup felt the landings data were appropriate and recommended for use in the assessment model. The landings time series ran from 1872-2020. As part of new discussion of the research track SEDAR 74 assessment, an effort was made to assign uncertainty in the commercial landings given the best available information and science.

**Decision 5 :** It was decided that for the historical commercial landings 1872 – 1961, the uncertainty or Coefficient of Variation (CV) around the landings agreed to be set to 0.5 for landings in the Western subregion, 0.6 for the Central and Eastern subregions.

With the annual reporting to the ALS, the workgroup agreed that commercial landings were more certain and CV was assumed to drop to 0.25. Additional certainty in the landing were assumed for the period 1977 to 1985 when landings began to be reported monthly and the CV was reduced to 0.2. Starting in 1986, Florida’s state Trip Ticket Program (TTP) was the first state in the Southeastern region where commercial landings data collections came officially into effect (Donaldson 2004). It was decided that with the onset of trip level data collection of the state TTPs, the landings CV should drop to 0.15 for the Eastern subregion starting in 1986. As the TTPs in the other four states, Texas, Louisiana, Mississippi, and Alabama became official, the CV of the West and Central subregions were reduced to 0.15. With the onset of the IFQ program in 2007, the group decided that CV could be set to 0.05 for the time period after the IFQ became into effect to the final year, which is 2020.

The Commercial Work Group recommended uncertainties/CVs for the whole time series are shown in Table 3.7.

The provided discard and bycatch estimates were also recommended by the Work Group for use in the assessment models. Uncertainty of those discard estimates, however, was greater than the level of uncertainty of the landings. There is a higher level of uncertainty in the discards for the period 1995 through 2006 as these estimates are based upon data from self-reported discard logbooks. Estimates of discards for the years 2007-2020 from the reef fish observer data were assumed by the Work Group to have less uncertainty than the estimates from discard logbook data. New methods are in development for estimating bycatch from the shrimp fishery, therefore the bycatch estimates provided at the Data Workshop were considered to be temporary proxy values to be replaced upon completion of the new estimation methods. Shrimp fishery bycatch estimates using newly developed methods should be available for use in the operational assessment to follow the research track assessment.

The Work Group recommend that the length composition data be used in the assessment models. Size composition data was adequate in most strata; however some strata did have small sample sizes. This was especially the case for longline samples in the western Gulf. Length distribution data of discarded fish from samples obtained from the observer program were recommended for use in the assessment models.

### 3.8 RESEARCH RECOMMENDATIONS

- Explore estimating gear selectivity using kept and discarded size data from the reef fish observer program.

- Investigate improving biological sampling of observer program by expanding sampling of otoliths paired with length data. Sampling should be completed without affecting fishing behavior and that may be possible by having sampling occur during breaks in fishing activity.
- Consider issuing research permits to fishers to retain catch below minimum size to collect samples for age length keys.
- Observer sampling may be supplemented by buying a percentage of catch for fish that cannot be extracted without causing damage to fish.
- Investigate trip ticket data for market category compared to length compositions. This analysis may provide some signal of age classes within the data.
- Consideration of the effect that resolutions of market category on trip tickets differ among states.

### 3.9 LITERATURE CITED

- Atkinson, S., Gocke, J. Martinez, S., Scott-Denton, E. 2022. Reef Fish Observer Program Metadata. SEDAR74-DW-02. SEDAR, North Charleston, SC. 20pp.
- Atkinson, S., Judge, M., Orhun, R. 2022. Coastal Fisheries Logbook Program Metadata. SEDAR74-DW-03. SEDAR, North Charleston, SC. 19pp.
- Donaldson, D.M. 2004. Overview of the State Trip Tickets Programs in the Gulf of Mexico. SEDAR7-DW-20. SEDAR, North Charleston, SC. 11pp.
- Gloeckner, D.R. 2014. Description of Commercial Landings Programs in the Southeast and ALS Database. SEDAR-PW6-RD57. SEDAR, North Charleston, SC. 18pp.
- Martinez, S.R., Atkinson, S., Smith, S.G. McCarthy, K.J. 2022. CPUE Expansion Estimation for Commercial Discards of Gulf of Mexico Red Snapper. SEDAR74-DW-19. SEDAR, North Charleston, SC. 36pp.
- McCarthy, K. 2013. Calculated discards of gray triggerfish and blueline tilefish from US South Atlantic commercial fishing vessels. SEDAR32-DW-11. 17 pp.
- McCarthy, K. 2015. Discards of Red Snapper Calculated for Commercial Vessels with Federal Fishing Permits in the US South Atlantic. SEDAR41-DW36. 18 pp.
- Orhun, M.R. 2022. Commercial Landings of Red Snapper (*Lutjanus campechanus*) from the Gulf of Mexico 1964-2020. SEDAR74-DW-22. SEDAR, North Charleston, SC. 11pp.
- Poffenberger, J. 2003. Description of the Southeast Fisheries Science Center's Logbook Program for Coastal Fisheries. SEDAR4-DW-29. SEDAR, North Charleston, SC. 9pp.
- Poffenberger, J. 2004. Commercial landings Statistics – Red Snapper in the Gulf of Mexico. SEDAR7-DW-23. SEDAR, North Charleston, SC. 13pp.
- Porch, C.E., S.C. Turner, M.J. Schirripa. 2004. The Commercial landings of red snapper in the Gulf of Mexico from 1872 to 1962. SEDAR7-AW-22. SEDAR, North Charleston, SC. 12pp.

Smith, S.G., S. F. Atkinson, and S. Martinez-Rivera. 2022. Estimation of length composition of commercial discards for Gulf of Mexico red snapper. SEDAR Working Paper SEDAR74-DW-37. SEDAR, North Charleston, SC.

Stephen, J.A. 2012. Brief overview on Gulf of Mexico Red Snapper IFQ Program. SEDAR31-DW02. SEDAR, North Charleston, SC. 6 pp.

Stevens, M.H. 2022. Gulf of Mexico Red Snapper (*Lutjanus campechanus*) Commercial and Recreational Landings Length and Age Compositions. SEDAR74-DW-14. SEDAR, North Charleston, SC. 23pp.

### 3.10 TABLES

**Table 3.1.** Annual Red Snapper landings in Whole Weight (Pounds) from 1872 – 2020 by the three subregions, West, Central and East.

Year	Handline+ West	Longline West	Handline+ Central	Longline Central	Handline+ East	Longline East
1872	-	-	521,326	-	-	-
1873	-	-	781,989	-	-	-
1874	-	-	1,172,984	-	-	-
1875	-	-	1,433,647	-	-	-
1876	-	-	1,694,310	-	-	-
1877	-	-	1,433,647	-	-	-
1878	-	-	1,303,315	-	-	-
1879	-	-	1,433,647	-	-	-
1880	1,824,641	-	891,034	-	-	-
1881	2,052,381	-	801,943	-	-	-
1882	2,282,108	-	711,859	-	-	-
1883	2,509,861	-	622,987	-	11,326	-
1884	2,737,622	-	536,883	-	19,882	-
1885	2,965,390	-	452,609	-	25,616	-
1886	3,195,145	-	372,056	-	28,616	-
1887	3,422,926	-	185,761	-	18,209	-
1888	3,277,425	-	190,078	-	22,806	-
1889	3,483,431	-	235,665	-	33,662	-
1890	4,192,327	-	207,888	-	34,643	-
1891	3,822,273	-	226,227	-	43,314	-

1892	4,010,384	-	240,829	-	52,346	-
1893	4,132,232	-	250,697	-	61,272	-
1894	4,227,631	-	255,258	-	69,605	-
1895	4,125,291	-	256,349	-	77,489	-
1896	4,167,613	-	255,676	-	85,212	-
1897	4,138,252	-	249,410	-	91,232	-
1898	4,612,379	-	389,069	-	155,602	-
1899	5,146,576	-	503,283	-	219,342	-
1900	5,674,141	-	603,947	-	286,029	-
1901	6,027,029	-	674,216	-	346,156	-
1902	6,283,575	-	723,927	-	402,107	-
1903	5,722,123	-	662,424	-	397,378	-
1904	5,286,731	-	614,310	-	397,416	-
1905	4,756,040	-	554,522	-	386,406	-
1906	4,240,944	-	495,858	-	371,815	-
1907	3,743,104	-	438,252	-	353,353	-
1908	3,363,251	-	394,205	-	341,568	-
1909	2,890,857	-	327,809	-	305,131	-
1910	2,436,701	-	308,336	-	229,773	-
1911	2,455,472	-	302,269	-	225,251	-
1912	2,473,439	-	296,742	-	221,132	-
1913	2,491,078	-	291,356	-	217,119	-
1914	2,507,351	-	285,829	-	213,000	-
1915	2,522,773	-	280,302	-	208,881	-
1916	2,537,294	-	274,236	-	204,360	-
1917	2,479,260	-	268,708	-	200,242	-
1918	2,492,553	-	263,182	-	196,123	-
1919	2,718,931	-	270,102	-	201,280	-
1920	2,954,424	-	277,021	-	206,437	-
1921	3,198,932	-	284,623	-	212,101	-
1922	3,452,171	-	291,542	-	217,258	-
1923	3,707,316	-	298,462	-	222,414	-
1924	3,621,389	-	288,320	-	214,856	-

1925	3,627,316	-	278,177	-	207,297	-
1926	3,532,334	-	267,892	-	199,633	-
1927	3,857,579	-	335,725	-	250,182	-
1928	3,444,187	-	244,597	-	182,274	-
1929	3,658,800	-	238,994	-	178,099	-
1930	2,233,495	-	317,189	-	236,370	-
1931	2,249,781	-	196,421	-	146,373	-
1932	2,416,037	-	235,678	-	175,627	-
1933	2,184,361	-	256,488	-	191,135	-
1934	1,964,863	-	266,296	-	198,444	-
1935	2,411,025	-	386,849	-	288,281	-
1936	2,773,983	-	499,305	-	372,083	-
1937	2,458,439	-	542,387	-	404,188	-
1938	3,180,371	-	535,944	-	399,386	-
1939	3,732,701	-	489,611	-	364,858	-
1940	2,496,953	-	467,494	-	348,377	-
1941	2,271,791	-	422,812	-	315,080	-
1942	1,818,353	-	312,078	-	232,561	-
1943	1,446,274	-	212,805	-	158,583	-
1944	1,670,030	-	160,262	-	119,428	-
1945	1,455,205	-	88,094	-	65,647	-
1946	2,319,802	-	185,309	-	138,092	-
1947	2,432,194	-	273,998	-	204,183	-
1948	2,598,682	-	341,176	-	254,245	-
1949	3,108,401	-	498,392	-	371,402	-
1950	1,693,118	-	845,776	-	630,272	-
1951	2,016,917	-	846,630	-	630,910	-
1952	2,245,040	-	947,843	-	706,333	-
1953	2,026,470	-	778,473	-	580,119	-
1954	1,883,191	-	782,708	-	583,274	-
1955	2,106,652	-	854,938	-	637,101	-
1956	2,520,865	-	1,155,982	-	861,438	-
1957	2,261,891	-	1,153,745	-	859,772	-



1958	3,724,587	-	1,923,784	-	1,433,606	-
1959	3,407,851	-	1,966,308	-	1,465,294	-
1960	3,816,825	-	2,063,477	-	1,537,705	-
1961	3,504,256	-	2,434,658	-	1,814,309	-
1962	3,612,712	-	2,367,407	-	1,764,194	-
1963	3,818,000	-	1,720,146	-	1,281,854	-
1964	3,590,301	-	1,949,662	-	1,657,008	-
1965	3,646,081	-	2,087,968	-	1,624,596	-
1966	3,041,229	-	1,659,432	-	1,439,333	-
1967	4,230,951	-	1,883,080	-	1,023,864	-
1968	5,160,886	-	1,555,387	-	1,062,159	-
1969	4,187,460	-	1,501,106	-	940,836	-
1970	4,652,728	-	1,360,293	-	949,161	-
1971	5,366,029	-	1,424,258	-	799,311	-
1972	4,841,776	-	1,508,522	-	865,800	-
1973	4,867,197	-	1,952,058	-	760,974	-
1974	4,433,800	-	1,942,947	-	1,824,618	-
1975	3,932,964	-	1,960,575	-	1,616,049	-
1976	3,325,599	1,074	1,740,786	-	1,547,340	-
1977	2,873,097	-	1,347,609	-	916,140	-
1978	2,694,000	-	1,238,528	-	757,823	-
1979	2,472,483	-	1,280,359	-	757,536	-
1980	2,516,508	44,054	1,302,555	60,601	593,193	33,404
1981	3,143,304	49,261	1,572,572	88,141	555,083	91,717
1982	3,661,535	71,617	1,754,198	81,139	537,709	145,435
1983	3,820,146	98,736	1,954,159	108,273	433,381	336,750
1984	2,906,413	762,672	1,230,559	104,198	401,357	264,251
1985	1,846,043	604,890	1,211,465	30,978	412,307	83,360
1986	1,933,384	831,375	719,097	32,293	140,734	43,604
1987	1,474,284	734,038	691,675	28,380	105,143	35,094
1988	2,355,109	670,131	752,113	54,320	105,845	22,346
1989	1,891,961	454,743	609,907	54,811	63,178	23,762
1990	1,757,785	120,420	577,232	13,473	120,384	61,318

1991	1,724,709	72,592	370,173	5,597	25,005	15,111
1992	2,674,495	19,820	392,018	902	14,476	4,788
1993	2,901,543	20,291	400,297	2,315	36,561	12,921
1994	2,671,459	15,809	503,057	2,580	24,067	5,379
1995	2,735,402	17,506	159,714	1,232	13,027	7,228
1996	4,044,132	27,362	224,209	4,090	9,772	3,498
1997	4,589,500	31,418	176,250	1,190	8,161	3,437
1998	4,267,518	27,224	365,877	2,254	13,526	3,261
1999	4,227,816	91,321	501,877	704	48,427	5,811
2000	3,979,513	184,426	632,529	1,039	32,093	7,519
2001	3,705,640	124,972	749,136	662	35,447	9,418
2002	3,565,505	146,691	1,016,265	6,572	36,180	11,608
2003	3,204,760	170,163	969,243	3,675	52,540	10,293
2004	3,224,112	456,817	898,310	3,594	54,376	15,760
2005	3,000,269	282,912	725,355	1,817	74,012	19,334
2006	3,615,632	256,820	670,201	1,110	95,144	15,511
2007	2,101,832	189,356	816,734	10,048	55,734	5,642
2008	1,582,401	56,204	754,661	18,686	55,910	14,509
2009	1,498,216	51,763	809,500	6,476	109,326	8,151
2010	1,880,162	38,356	1,188,292	11,069	208,566	64,568
2011	1,879,064	18,391	1,360,013	4,678	254,480	77,772
2012	2,120,547	13,504	1,612,829	1,284	237,573	50,662
2013	2,997,578	50,717	1,985,033	2,277	304,678	108,228
2014	3,261,930	55,486	1,712,170	7,850	414,051	112,624
2015	3,970,288	49,943	2,364,981	39,192	541,447	210,646
2016	3,950,774	71,219	2,119,735	20,997	398,291	162,467
2017	3,997,846	65,565	2,243,309	7,117	494,756	169,188
2018	3,936,448	66,639	2,098,679	45,579	570,560	257,489
2019	4,120,426	157,549	2,206,933	32,976	751,388	385,610
2020	3,931,978	68,747	2,234,664	22,477	696,916	410,612

**Table 3.2** Commercial landings of Red Snapper in the Gulf of Mexico in numbers of fish based on average weights calculated from TIP program 1984 – 2020.

YEAR	W_VL+	C_VL+	E_VL+	W_LL+	C_LL+	E_LL+
1984	1,019,794	449,109	54,980	96,297	10,236	26,035
1985	647,734	442,141	56,480	76,375	3,043	8,213
1986	678,380	262,444	19,279	104,972	3,172	4,296
1987	517,293	252,436	14,403	92,682	2,788	3,458
1988	826,354	274,494	14,499	84,613	5,336	2,202
1989	663,846	222,594	8,655	57,417	5,384	2,341
1990	616,767	210,669	16,491	15,205	1,323	6,041
1991	511,783	133,156	4,014	7,690	985	1,606
1992	793,619	141,014	2,324	2,100	159	509
1993	860,992	143,992	5,869	2,149	408	1,373
1994	792,718	180,956	3,863	1,675	454	572
1995	811,692	57,451	2,091	1,854	217	768
1996	993,644	63,157	2,305	2,853	288	426
1997	1,127,641	49,648	1,925	3,276	84	419
1998	1,048,530	103,064	3,190	2,839	159	397
1999	1,038,775	141,374	11,421	9,523	50	708
2000	977,767	178,177	7,569	19,231	73	916
2001	1,052,739	222,957	6,856	12,051	87	1,292
2002	1,012,928	302,460	6,998	14,146	860	1,592
2003	910,443	288,465	10,162	16,409	481	1,412
2004	915,941	267,354	10,518	44,052	470	2,162
2005	852,349	215,879	14,316	27,282	238	2,652
2006	1,033,038	228,738	19,988	27,526	177	2,332
2007	600,523	278,749	11,709	20,295	1,605	848
2008	452,115	257,563	11,746	6,024	2,985	2,182
2009	428,062	276,280	22,968	5,548	1,035	1,226
2010	537,189	405,560	43,816	4,111	1,768	9,709
2011	431,969	346,059	36,251	1,837	693	9,770
2012	487,482	410,389	33,842	1,349	190	6,365
2013	689,098	505,097	43,401	5,067	337	13,596
2014	749,869	435,667	58,982	5,543	1,163	14,149

2015	912,710	601,776	77,129	4,989	5,806	26,463
2016	906,141	568,294	70,494	5,896	2,378	22,850
2017	916,937	601,423	87,567	5,428	806	23,796
2018	902,855	562,649	100,984	5,516	5,162	36,215
2019	945,052	591,671	132,989	13,042	3,735	54,235
2020	901,830	599,106	123,348	5,691	2,546	57,751

**Table 3.3.** Beginning year of adoption of State Trip Ticket Programs (TTP) in the Gulf of Mexico Fisheries Management Council (GMFMC) region.

Year	State
1986	Florida
2000	Louisiana
2002	Alabama
2006	Texas
2012	Mississippi

**Table 3.4.1.1.** Calculated yearly total discards of Red Snapper from vertical line vessels by region and Red Snapper season (open/closed). Discards are reported as number of fish.

Year	VL east closed season	VL central closed season	VL west closed season	VL east open season	VL central open season	VL west open season
1995	49,407	814,917	97,838	7,949	131,749	367,594
1996	44,801	776,910	86,785	13,888	154,510	639,217
1997	45,591	625,567	146,697	10,113	150,278	771,885
1998	40,922	613,507	112,030	10,295	166,751	867,539
1999	45,994	715,912	141,937	11,262	206,946	926,415
2000	43,318	568,572	140,452	10,981	259,730	843,145
2001	35,597	524,182	96,650	9,214	314,874	978,141
2002	34,744	506,465	113,240	12,238	366,366	962,175
2003	30,947	602,113	113,700	13,150	439,970	979,275
2004	47,398	462,990	89,771	12,099	396,933	1,022,326
2005	24,559	320,799	71,675	13,601	387,232	1,062,369
2006	26,249	341,403	44,702	15,648	426,410	1,178,932

**Table 3.4.1.2.** Calculated yearly total discards of Red Snapper from bottom longline vessels by region and Red Snapper season (open/closed). Discards are reported as number of fish.

Year	BLL east closed season	BLL central closed season	BLL west closed season	BLL east open season	BLL central open season	BLL west open season
1995	10,629	596	710	2,106	48	1,608
1996	10,995	531	564	3,343	74	1,031
1997	13,103	588	348	3,238	65	662
1998	13,039	410	398	2,528	52	744
1999	14,040	275	786	3,432	51	2,331
2000	11,891	534	590	2,959	54	2,014
2001	11,817	507	410	2,660	62	1,192
2002	9,608	498	517	3,151	92	1,881
2003	10,705	642	656	2,831	94	3,543
2004	9,411	404	560	3,604	138	5,294
2005	6,199	430	465	3,151	94	4,387
2006	7,622	403	334	4,153	117	4,110

**Table 3.4.1.3.** Mean weight (pounds whole weight) of discards as reported from the reef fish observer program. Mean weights are by gear (bottom longline and vertical line) and amount of IFQ allocation. Sample size in number of fish and standard errors are also provided.

Gear	No IFQ (discard only trips)			IFQ (discards & kept trips)		
	N fish	Mean weight pounds (wwt)	SE	N fish	Mean weight pounds (wwt)	SE
Bottom Longline	190	6.22	0.092	53	5.22	0.174
Vertical Line	482	3.3	0.035	1,520	1.57	0.016

**Table 3.4.1.4.** Calculated yearly total discards of Red Snapper from vertical line vessels by region and Red Snapper season (open/closed). Discards are reported in whole pounds.

Year	VL east closed season	VL central closed season	VL west closed season	VL east open season	VL central open season	VL west open season
1995	163,059	2,689,484	322,898	12,478	206,805	577,008
1996	147,857	2,564,047	286,416	21,801	242,533	1,003,373
1997	150,466	2,064,569	484,146	15,874	235,889	1,211,620
1998	135,054	2,024,767	369,734	16,160	261,747	1,361,767
1999	151,794	2,362,737	468,437	17,679	324,841	1,454,183
2000	142,965	1,876,469	463,536	17,236	407,695	1,323,475
2001	117,480	1,729,967	318,975	14,463	494,254	1,535,378
2002	114,666	1,671,494	373,729	19,210	575,081	1,510,315
2003	102,134	1,987,164	375,245	20,641	690,616	1,537,157
2004	156,429	1,528,012	296,272	18,992	623,061	1,604,735
2005	81,054	1,058,737	236,551	21,349	607,835	1,667,590
2006	86,631	1,126,738	147,532	24,562	669,332	1,850,557

**Table 3.4.1.5.** Calculated yearly total discards of Red Snapper from bottom longline vessels by region and Red Snapper season (open/closed). Discards are reported in whole pounds.

Year	BLL east closed season	BLL central closed season	BLL west closed season	BLL east open season	BLL central open season	BLL west open season
1995	66,106	3,707	4,415	10,995	249	8,397
1996	68,383	3,304	3,508	17,450	388	5,382
1997	81,489	3,657	2,166	16,902	340	3,456
1998	81,095	2,552	2,473	13,199	274	3,883
1999	87,319	1,707	4,888	17,917	268	12,167
2000	73,953	3,320	3,669	15,449	280	10,513
2001	73,492	3,154	2,547	13,887	324	6,221
2002	59,755	3,094	3,218	16,449	478	9,819
2003	66,578	3,991	4,078	14,777	492	18,496
2004	58,530	2,516	3,482	18,814	722	27,640
2005	38,555	2,673	2,894	16,450	491	22,904
2006	47,406	2,507	2,077	21,681	609	21,457

**Table 3.4.2.1.** Time-series of CPUE expansion estimates for GOM Red Snapper vertical line discards in weight (lbs.) and numbers (with associated standard errors) for each of the three sub-regions or zones, i.e. a) West, b) Central and c) East.

## WEST

Year	Estimated Discards in Weight	SE of Estimated Discards in Weight	Estimated Discards in Number	SE of Estimated Discards in Number
2007	711,751	421,446	466,911	266,427
2008	281,484	107,565	131,928	62,846
2009	238,446	91,118	111,757	53,237
2010	196,645	75,145	92,165	43,904
2011	194,100	74,172	90,972	43,336
2012	220,756	84,358	103,466	49,287
2013	215,423	82,321	100,966	48,097
2014	65,024	29,304	27,537	12,480
2015	78,156	35,222	33,730	15,286
2016	72,909	32,857	31,153	14,118
2017	71,023	32,007	30,071	13,628
2018	62,115	27,993	25,897	11,736
2019	66,023	29,754	27,497	12,462

## CENTRAL

Year	Estimated Discards in Weight	SE of Estimated Discards in Weight	Estimated Discards in Number	SE of Estimated Discards in Number
2007	118,238	22,475	83,383	13,829
2008	143,175	38,570	49,728	12,146
2009	149,013	40,143	51,756	12,642
2010	168,285	45,335	58,449	14,276
2011	204,447	55,076	71,009	17,344
2012	223,893	60,315	77,763	18,994
2013	179,491	48,353	62,341	15,227
2014	122,821	44,250	66,197	19,524
2015	120,115	43,275	66,713	19,676
2016	132,360	47,687	72,065	21,255
2017	135,196	48,709	74,438	21,954
2018	112,937	40,689	62,429	18,413
2019	113,501	40,892	63,248	18,654

Table 3.4.2.1 Cont'd

## EAST

Year	Estimated Discards in Weight	SE of Estimated Discards in Weight	Estimated Discards in Number	SE of Estimated Discards in Number
2007	31,260	7,571	8,544	1,950
2008	45,852	10,876	8,598	2,143
2009	66,779	15,841	12,487	3,113
2010	99,671	23,643	18,723	4,667
2011	114,624	27,190	21,726	5,416
2012	112,653	26,722	21,279	5,304
2013	128,029	30,369	24,330	6,065
2014	60,809	19,402	24,623	10,420
2015	58,352	18,618	22,530	9,534
2016	69,996	22,334	29,146	12,333
2017	66,261	21,142	28,138	11,907
2018	58,186	18,566	25,139	10,638
2019	55,768	17,794	24,532	10,381

**Table 3.4.2.2.** Time-series of CPUE expansion estimates for GOM Red Snapper bottom longline discards in weight (lbs.) and number (with associated standard errors).**Zone (West)**

Year	Estimated Discards in Weight	SE of Estimated Discards in Weight	Estimated Discards in Number	SE of Estimated Discards in Number
2007	8,588	8,109	878	785
2008	18,541	17,507	1,808	1,617
2009	31,730	29,960	3,042	2,720
2010	11,467	10,827	1,090	975
2011	3,804	3,591	364	325
2012	9,074	8,568	858	767
2013	31,045	29,312	2,955	2,643
2014	18,954	17,896	1,844	1,649
2015	56,136	53,004	5,293	4,733
2016	31,561	29,800	3,057	2,734
2017	33,425	31,560	3,195	2,857
2018	12,538	11,838	1,230	1,100
2019	32,446	30,635	3,163	2,829



Table 3.4.2.2 Cont'd

**Zone (Central)**

Year	Estimated Discards in Weight	SE of Estimated Discards in Weight	Estimated Discards in Number	SE of Estimated Discards in Number
2007	20,092	4,691	2,798	618
2008	20,934	4,887	2,916	644
2009	7,802	1,821	1,087	240
2010	10,874	2,539	1,515	335
2011	5,772	1,348	804	178
2012	1,476	345	206	45
2013	2,226	520	310	69
2014	8,917	2,082	1,242	274
2015	28,049	6,548	3,907	863
2016	13,158	3,072	1,833	405
2017	5,066	1,183	706	156
2018	24,336	5,682	3,390	749
2019	15,805	3,690	2,201	486

**Zone (East)**

Year	Estimated Discards in Weight	SE of Estimated Discards in Weight	Estimated Discards in Number	SE of Estimated Discards in Number
2007	21,132	4,884	2,953	645
2008	29,300	6,772	4,094	895
2009	13,483	3,116	1,884	412
2010	74,562	17,234	10,418	2,277
2011	98,725	22,819	13,795	3,014
2012	61,825	14,290	8,639	1,888
2013	102,890	23,782	14,377	3,141
2014	128,268	29,648	17,923	3,916
2015	191,681	44,305	26,783	5,852
2016	194,079	44,859	27,118	5,926
2017	199,460	46,103	27,870	6,090
2018	197,191	45,579	27,553	6,021
2019	241,854	55,902	33,794	7,384

**Table 3.4.3:** Annual bycatch estimates of red snapper from shrimp trawls for 3 subregions for 1972-2016.

Year	West	Central	East
1972	16020	689.5	234.3
1973	14460	908.3	308.7
1974	17550	516.9	175.6
1975	8357	907.6	308.4
1976	30000	808.3	274.7
1977	11320	1125.5	382.5
1978	6575	180.9	61.5
1979	21970	812.0	276.0
1980	25550	333.4	113.3
1981	53210	977.7	332.3
1982	23920	1207.6	410.4
1983	17560	853.8	290.2
1984	12510	611.4	207.8
1985	10440	506.1	191.1
1986	5441	165.7	51.8
1987	11760	233.5	91.5
1988	9602	282.3	98.5
1989	10500	517.8	137.5
1990	40970	1725.7	456.3
1991	40890	1402.2	435.8
1992	31660	944.2	345.8
1993	34900	486.7	264.3
1994	34400	702.3	388.7
1995	47470	934.2	527.8
1996	36260	493.6	567.4
1997	26290	1078.9	610.1
1998	56070	972.9	645.1
1999	23870	1396.5	467.5
2000	11960	1657.8	469.2

2001	23970	1633.5	682.5
2002	22140	1476.2	704.8
2003	30510	892.3	380.7
2004	27840	1019.9	393.1
2005	12250	423.0	202.5
2006	11430	1417.7	420.3
2007	6812	1056.0	161.0
2008	2710	126.6	33.9
2009	3726	282.8	68.6
2010	2779	119.9	70.3
2011	6389	453.8	151.6
2012	8494	314.9	71.6
2013	5979	395.0	114.0
2014	20170	95.1	32.4
2015	17260	563.4	163.0
2016	17260	583.3	143.1

**Table 3.5.** Annual estimates of GOM shrimp trawl effort for three subregions for 1945-2019.

Year	West	Central	East
1945	0.0	0.0	0.0
1946	1231.6	0.0	0.0
1947	6281.2	0.0	0.0
1948	16503.4	0.0	0.0
1949	26664.1	0.0	0.0
1950	32206.3	7356.1	2499.8
1951	33869.0	12673.7	4306.9
1952	39965.4	14978.0	5089.9
1953	38980.1	16543.8	5622.0
1954	51419.2	21211.5	7208.2
1955	42428.6	25052.0	8513.3
1956	55360.3	31728.6	10782.2
1957	69400.6	34741.9	11806.2

1958	107025.9	36750.8	12488.9
1959	114353.9	39882.3	13553.1
1960	98971.0	37083.9	12602.1
1961	82563.0	27194.6	9241.4
1962	100395.0	37087.6	12603.4
1963	111607.0	35832.2	12176.8
1964	136393.0	39752.2	13508.8
1965	113703.0	36909.3	12542.7
1966	115141.0	34528.3	11733.7
1967	133882.0	33713.3	11456.7
1968	142411.0	39873.1	13549.9
1969	159864.0	37369.0	12699.0
1970	135727.0	36050.9	12251.1
1971	143404.0	33587.2	11413.8
1972	176738.0	34950.8	11877.2
1973	165055.0	38978.2	13245.8
1974	169015.0	36077.8	12260.2
1975	150291.0	37011.5	12577.5
1976	163522.0	34241.7	11636.3
1977	167604.0	39835.0	13537.0
1978	192585.0	38975.9	13245.1
1979	226170.0	43560.9	14803.1
1980	161176.0	24633.8	8371.2
1981	181392.0	37780.3	12838.7
1982	177880.0	45253.6	15378.4
1983	180270.0	50527.4	17170.6
1984	187681.0	59484.6	20214.4
1985	185608.0	53429.7	20174.3
1986	244961.0	52409.3	16386.7
1987	258137.0	56902.7	22307.3
1988	231807.0	57259.0	19987.0
1989	234643.0	55050.5	14614.5

1990	239721.0	53072.1	14031.9
1991	246245.0	40889.7	12710.3
1992	261284.0	42922.6	15721.4
1993	232179.0	36929.0	20055.0
1994	240070.0	38039.7	21052.3
1995	183997.0	42780.9	24172.1
1996	188947.0	30015.5	34499.5
1997	222347.0	44273.1	25034.9
1998	207839.0	43770.5	29024.5
1999	208345.0	46547.9	15581.1
2000	208085.0	40543.7	11474.3
2001	220819.0	40251.1	16818.9
2002	233599.0	48082.1	22957.9
2003	200594.0	37856.0	16149.0
2004	168423.0	33361.2	12858.8
2005	117922.0	21706.3	10389.7
2006	114549.0	18920.3	5609.7
2007	99479.0	22464.5	3425.5
2008	81207.0	20262.9	5417.1
2009	100377.0	26171.2	6353.8
2010	84455.0	15103.1	8845.9
2011	95262.0	19897.1	6645.9
2012	94891.0	18079.8	4114.2
2013	84389.0	18111.5	5229.5
2014	96053.0	9893.3	3371.7
2015	92785.0	14526.3	4201.7
2016	102428.0	19298.7	4733.3
2017	94538.0	14257.1	7959.9
2018	93398.0	14938.8	8943.2
2019	78864.0	16701.9	7205.1

---

**Table 3.6.1.** Annual number of age samples for commercial vertical line (VL) and longline (LL) gears by stock.

Year	W_VL	W_LL	C_VL	C_LL	E_VL	E_LL
1991	25	0	178	0	0	12
1992	210	0	116	0	18	15
1993	312	29	136	0	13	30
1994	500	0	121	4	28	4
1995	97	0	85	0	7	19
1996	0	0	9	0	0	6
1997	0	0	1	3	31	7
1998	1,172	347	181	0	11	25
1999	1,797	76	902	0	70	102
2000	695	342	1,381	0	29	82
2001	1,026	179	1,233	14	65	75
2002	2,420	340	1,155	11	14	167
2003	1,393	256	1,473	27	9	168
2004	1,891	640	969	18	113	234
2005	2,313	252	1,097	34	68	311
2006	2,599	556	1,146	0	153	202
2007	1,446	352	1,077	93	54	124
2008	1,577	342	933	182	24	315
2009	2,124	270	929	20	595	678
2010	2,038	82	1,148	1	451	1,004
2011	1,660	14	2,776	120	599	453
2012	2,911	148	3,521	60	649	219
2013	1,499	115	1,922	133	640	585
2014	1,129	74	1,708	39	759	1,110
2015	1,646	104	2,285	63	556	800
2016	1,694	112	2,634	27	804	828
2017	1,240	132	3,123	21	1,114	528
2018	1,496	306	4,112	116	731	536
2019	1,120	681	4,329	76	948	775

**Table 3.6.2.** Annual number of commercial vertical line (VL) and longline (LL) gear trips sampled for ages by stock.

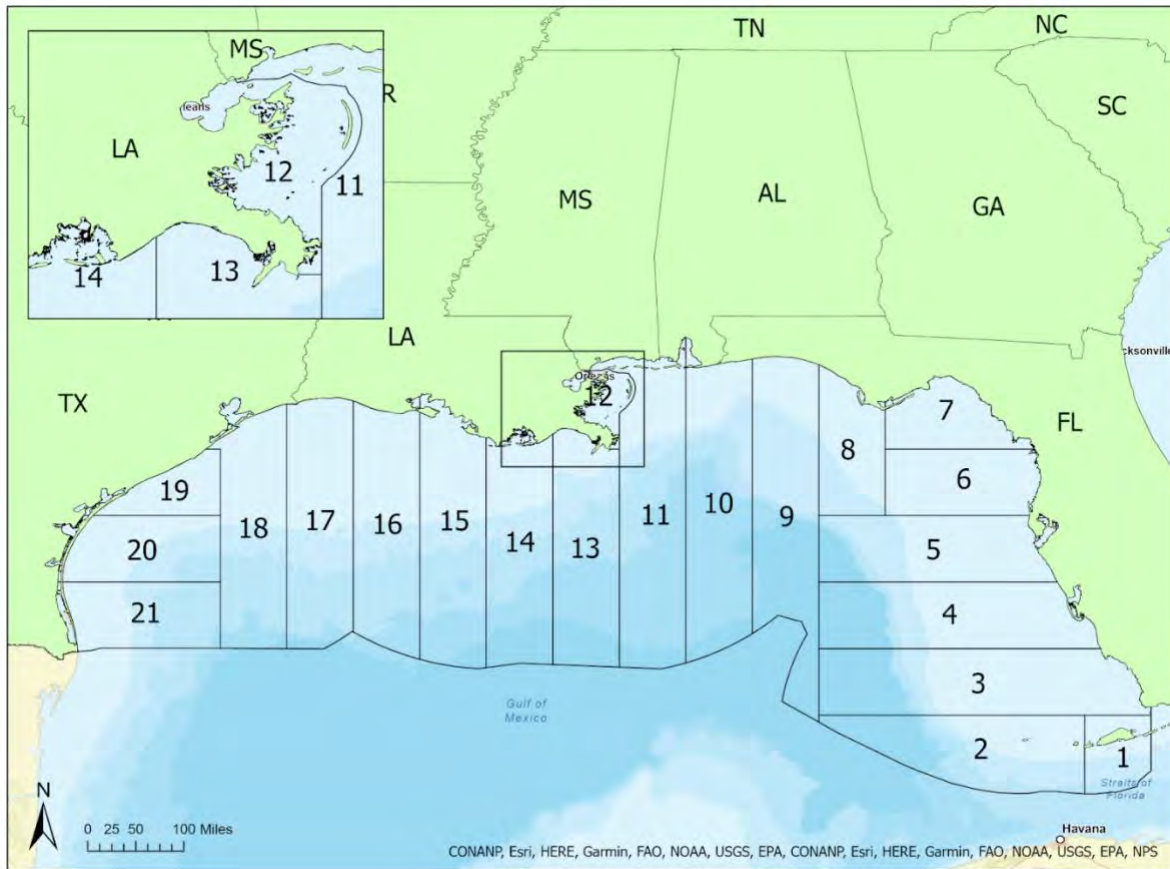
Year	W_VL	W_LL	C_VL	C_LL	E_VL	E_LL
1991	1	0	12	0	0	2
1992	16	0	4	0	6	4
1993	31	2	16	0	7	10
1994	54	0	23	1	6	3
1995	9	0	16	0	2	7
1996	0	0	3	0	0	4
1997	0	0	1	1	2	2
1998	45	6	7	0	3	6
1999	76	2	29	0	3	12
2000	37	14	56	0	4	7
2001	43	9	57	1	3	17
2002	105	15	55	2	5	37
2003	56	13	385	2	3	38
2004	71	24	51	2	11	40
2005	85	10	52	2	8	51
2006	80	17	53	0	43	40
2007	55	15	180	5	29	27
2008	108	25	110	36	23	81
2009	54	17	148	9	88	48
2010	68	5	367	1	179	614
2011	55	1	1,826	34	253	254
2012	115	9	1,690	17	266	111
2013	238	10	1,514	19	406	123
2014	221	10	1,286	17	389	110
2015	254	15	1,813	11	281	154
2016	250	16	2,124	12	689	712
2017	227	19	2,476	17	1,019	471
2018	241	20	3,422	69	714	511
2019	222	33	3,900	32	895	661

**Table 3.7** Expert opinion of uncertainty for the commercial fisheries landings from 1872-2020 based on differences in the collection of data over time (see text in Section 3.8).

YEAR	WEST	CENTRAL	EAST
1872-1961	0.50	0.60	0.60
1962-1976	0.25	0.25	0.25
1977-1985	0.20	0.20	0.20
1986	0.20	0.17	0.15
1987	0.20	0.17	0.15
1988	0.20	0.17	0.15
1989	0.20	0.16	0.15
1990	0.20	0.16	0.15
1991	0.20	0.16	0.15
1992	0.20	0.16	0.15
1993	0.20	0.17	0.15
1994	0.20	0.17	0.15
1995	0.20	0.18	0.15
1996	0.20	0.18	0.15
1997	0.20	0.18	0.15
1998	0.20	0.18	0.15
1999	0.20	0.16	0.15
2000	0.17	0.16	0.15
2001	0.17	0.16	0.15
2002	0.17	0.15	0.15
2003	0.17	0.15	0.15
2004	0.18	0.15	0.15
2005	0.18	0.15	0.15
2006	0.18	0.15	0.15
2007 to present	0.05	0.05	0.05

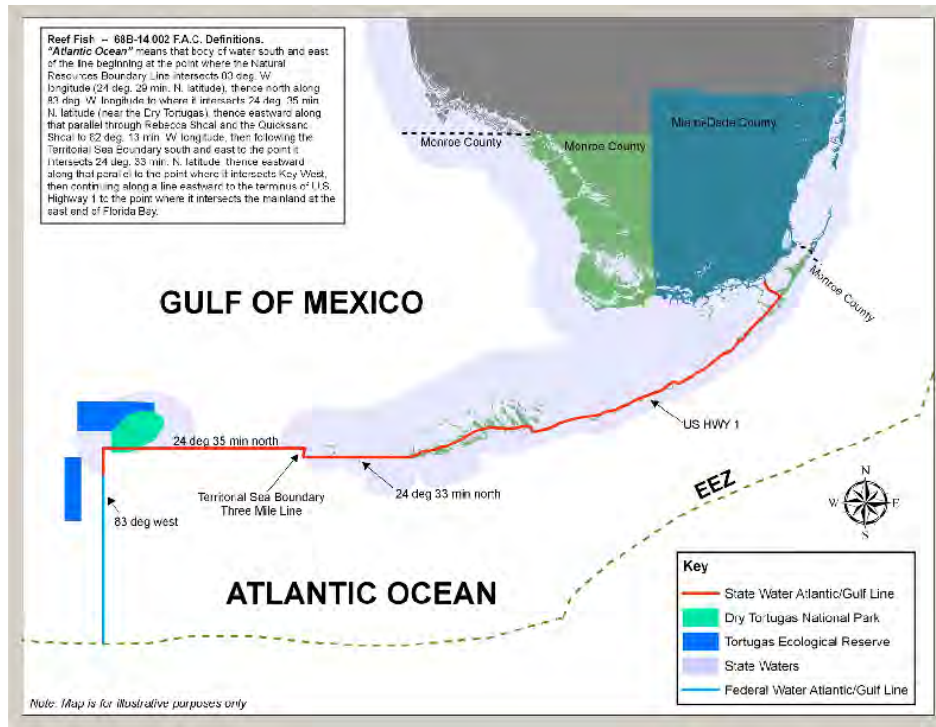


3.11 FIGURES

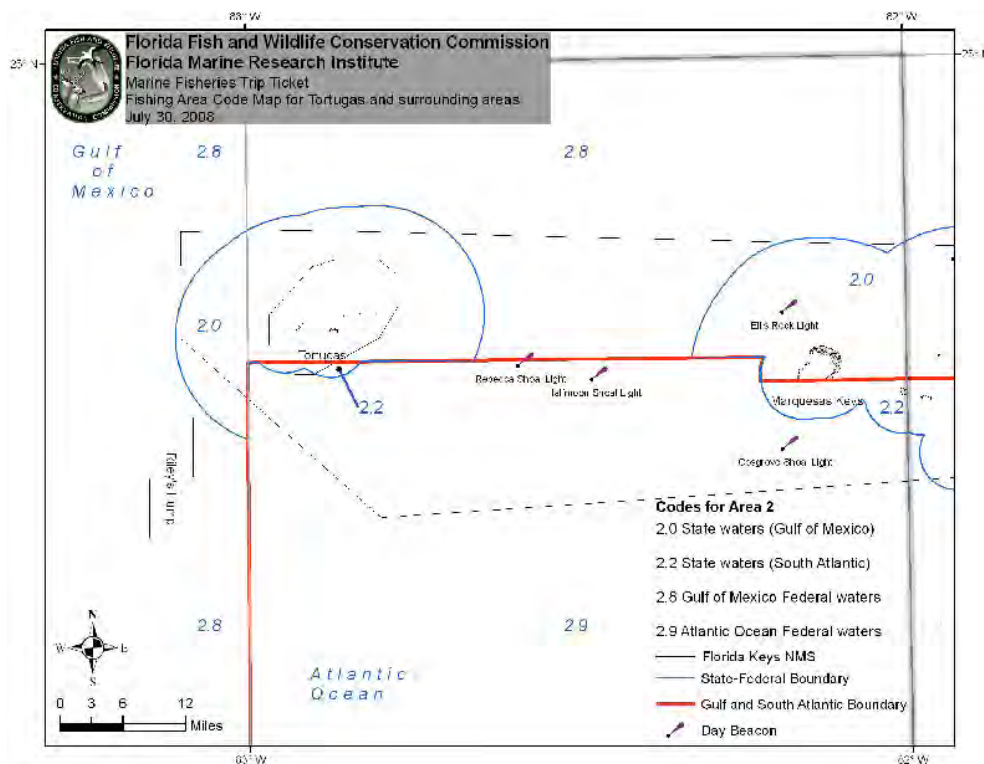


**Figure 3.1.** Map of NMFS Statistical Areas 1-21 in the Gulf of Mexico including a detail of the Areas 11-14 around outflow of the Mississippi.

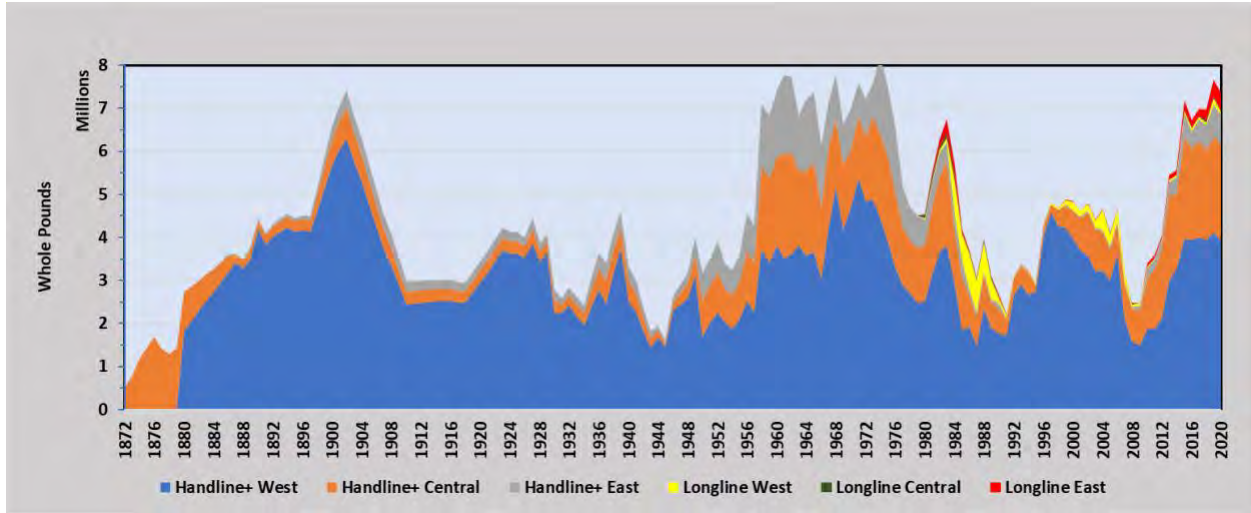
a



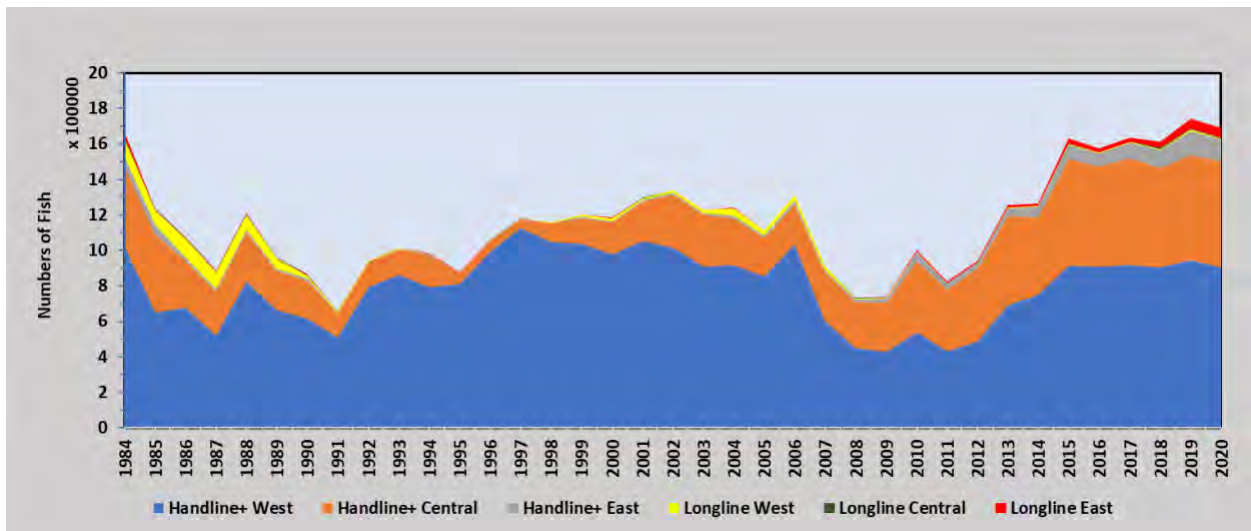
b



**Figure 3.2 a,b)** Maps are showing the GMFMC and SAFMC boundaries in the Florida Keys, namely US1 and its extension westward to Riley’s Humb and the Tortugas to the North

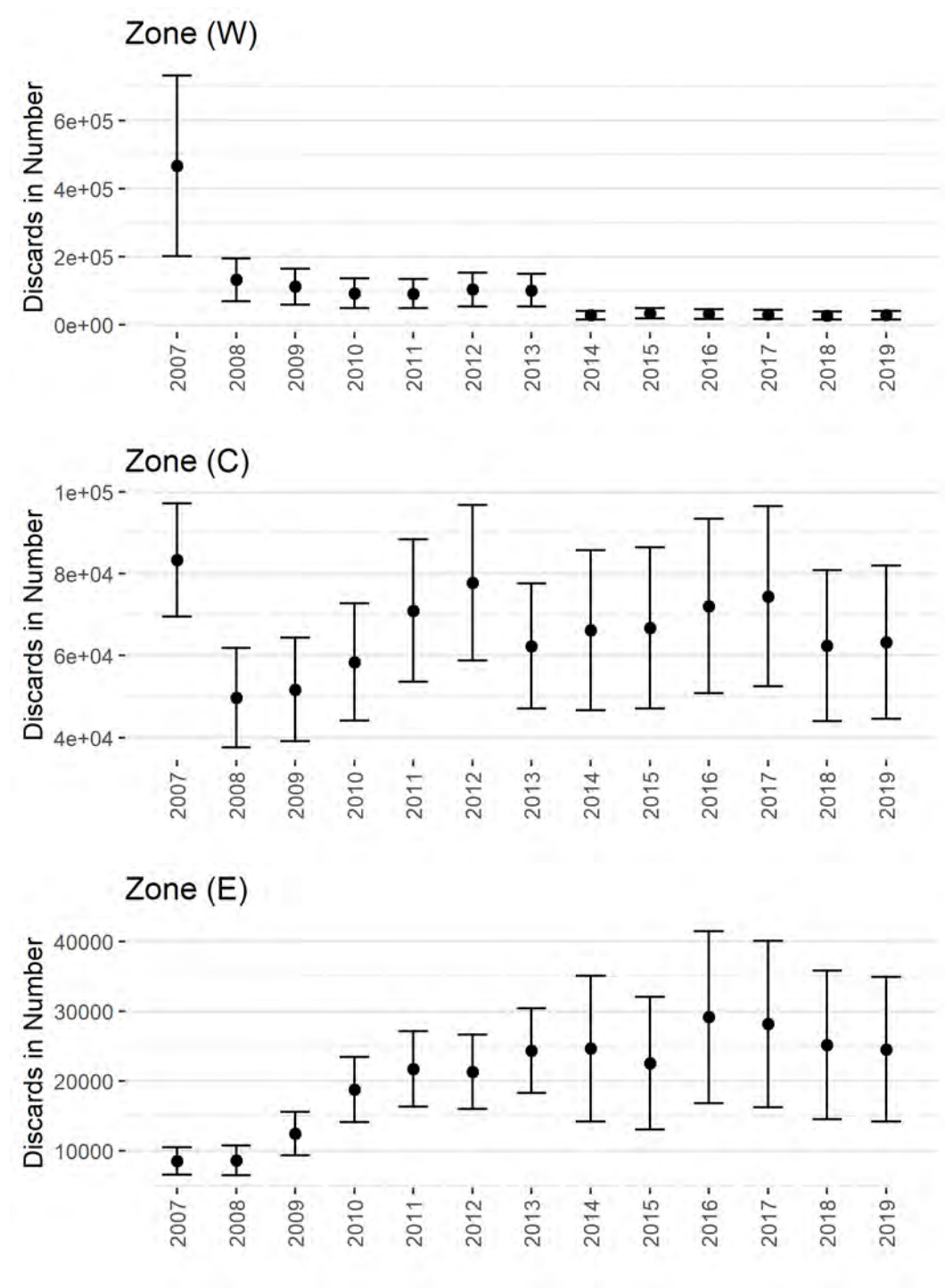


**Figure 3.3.1** Commercial landings of Gulf of Mexico Red Snapper by stock/zone/subregion in whole pounds 1872 to 2020 with expert opinion uncertainty/CV's as also shown in Table 3.7.



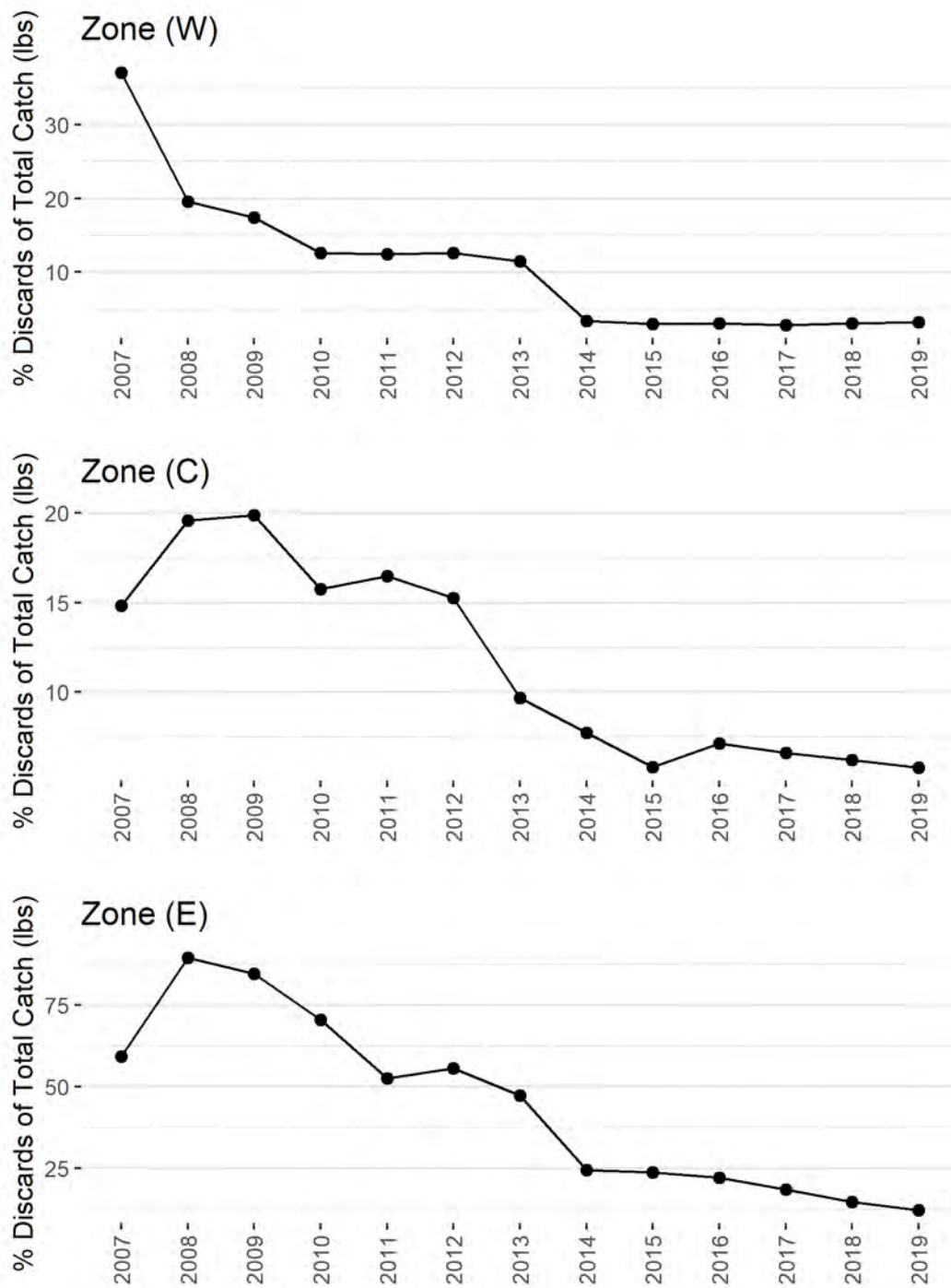
**Figure 3.3.2** Commercial landings of Gulf of Mexico Red Snapper by /stock/zone/subregion in numbers of fish 1984-2020 based average weights obtained from the TIP Observer Program.

Discards in Numbers (A)



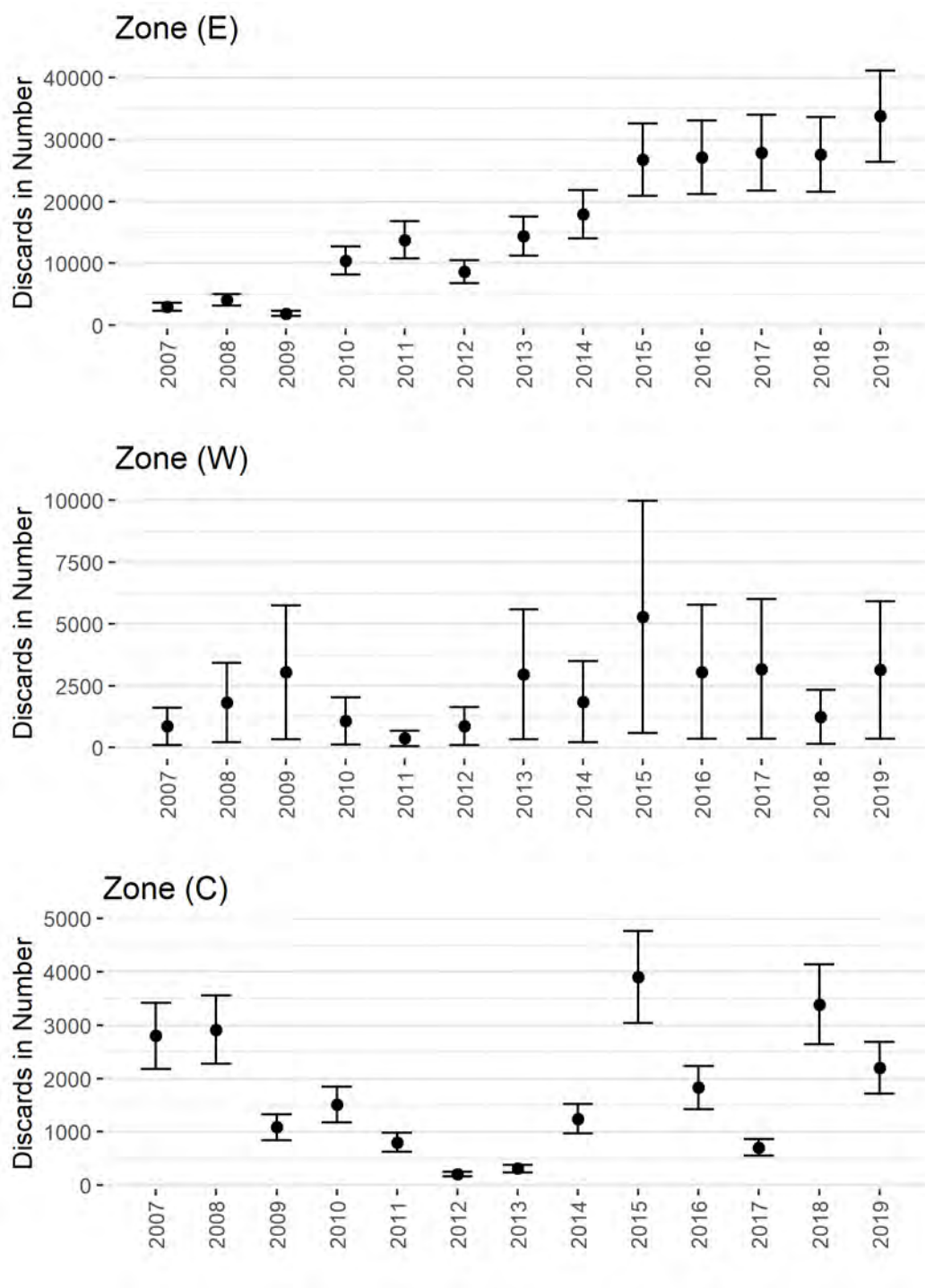


**Discards in Weight, Percentage of Total Catch (B)**

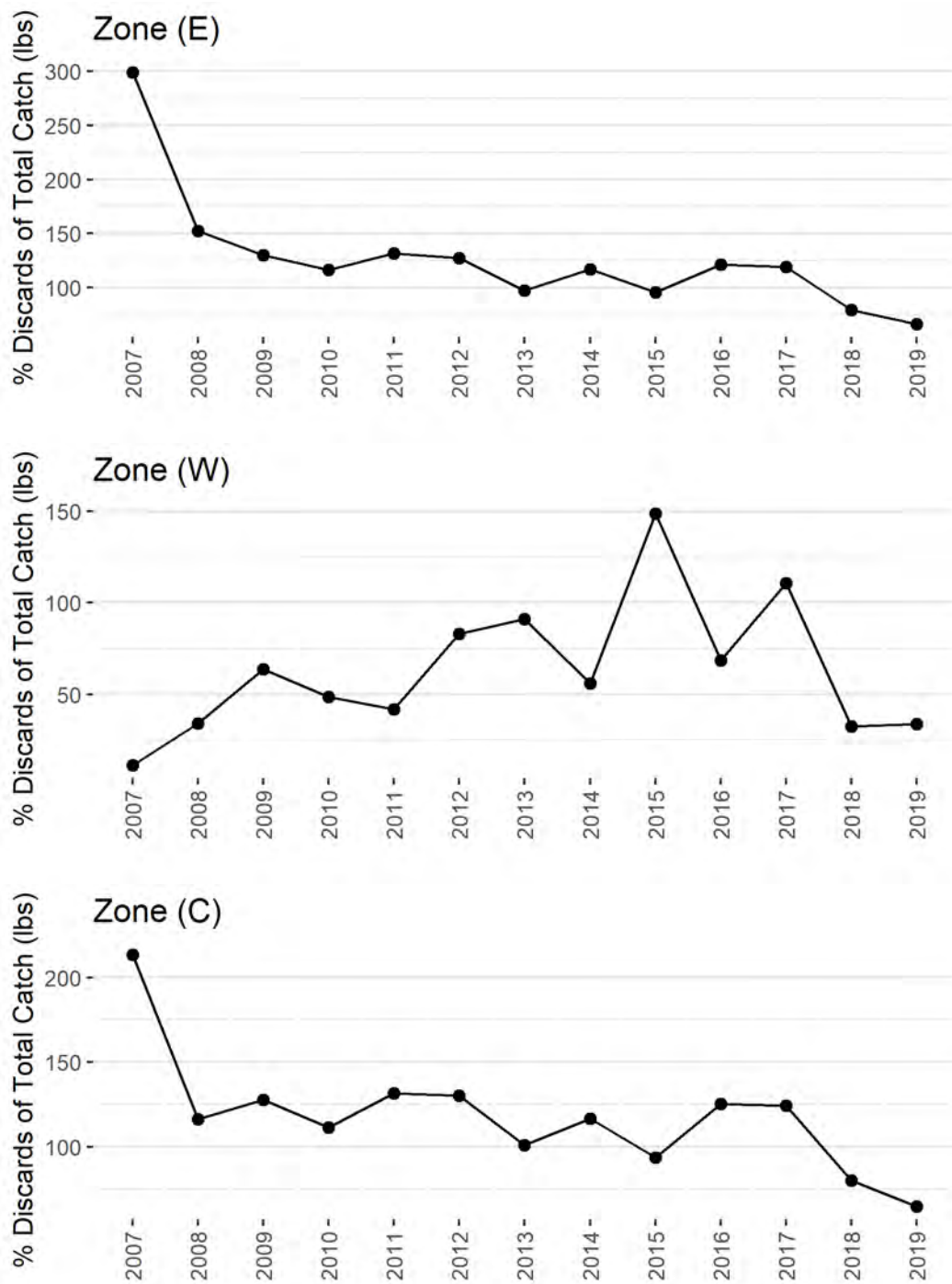


**Figure 3.4.3.1.** Observer CPUE expansion estimates of GOM Red Snapper vertical line annual discards (+/-SE) in (A) number and (B) weight expressed as percentage of total catch (kept + discards) for 2007 - 2019.

**Discards in Number (A)**



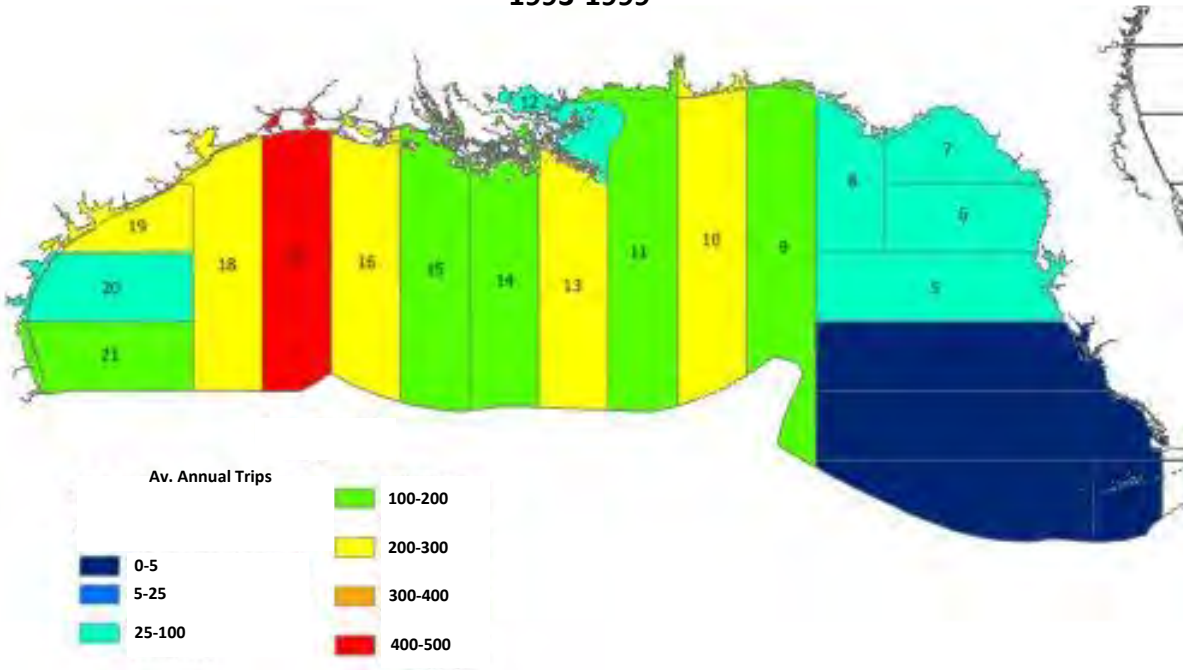
**Discards in Weight, Percentage of Total Catch (B)**



**Figure 3.4.3.2** Observer CPUE expansion estimates of GOM Red Snapper bottom longline annual discards (+/-SE) in (A) number and (B) weight expressed as percentage of total catch (kept + discards) for 2007 - 2019.

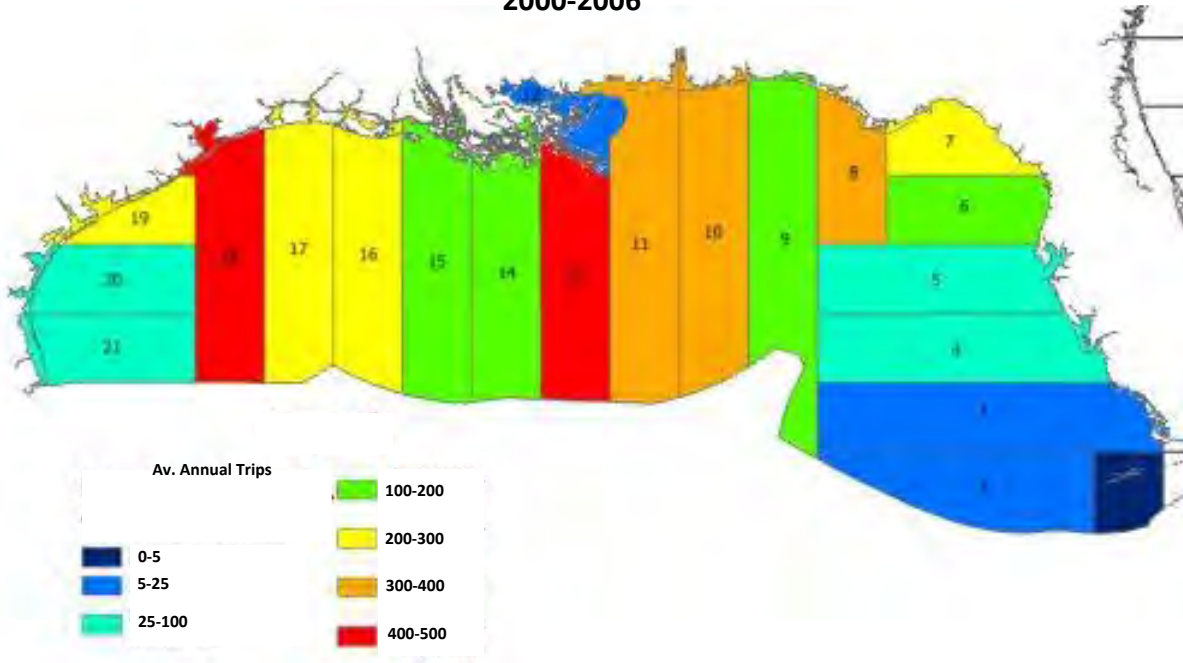
(A)

### Commercial Vertical Line Red Snapper Trips 1993-1999



(B)

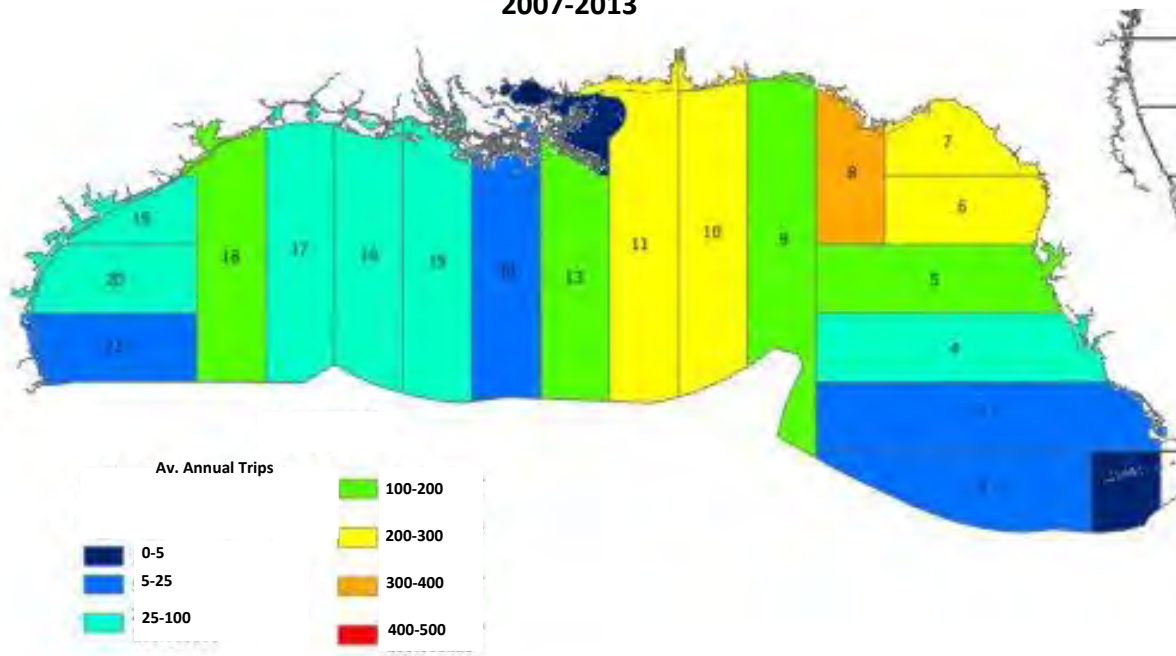
### Commercial Vertical Line Red Snapper Trips 2000-2006





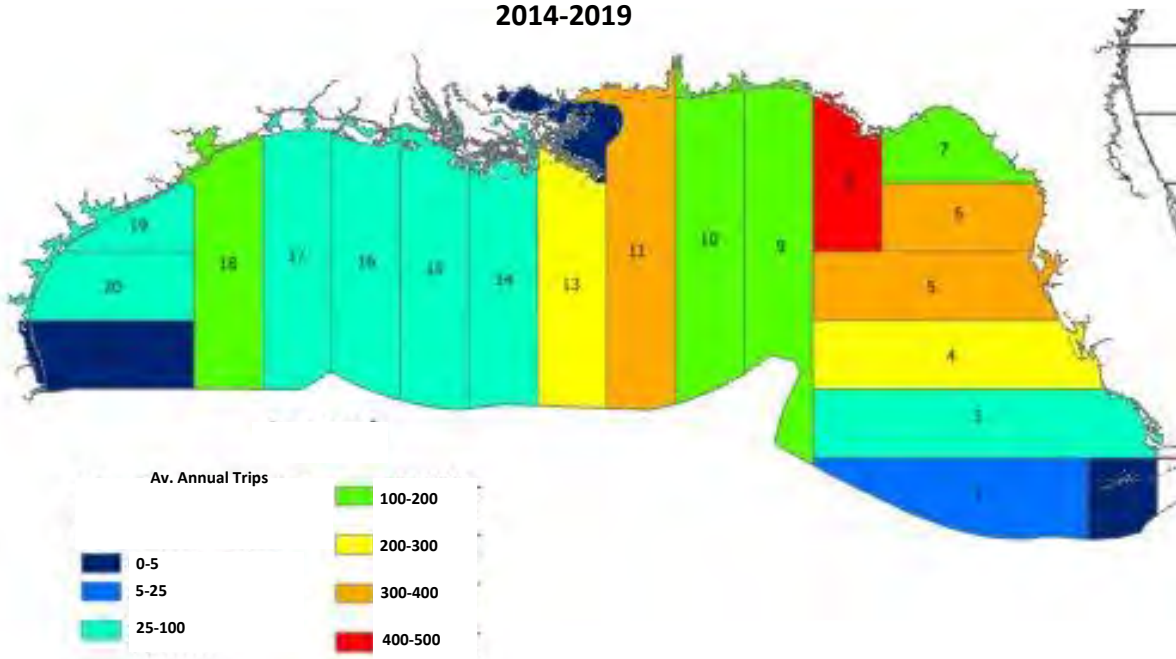
(C)

**Commercial Vertical Line Red Snapper Trips  
2007-2013**



(D)

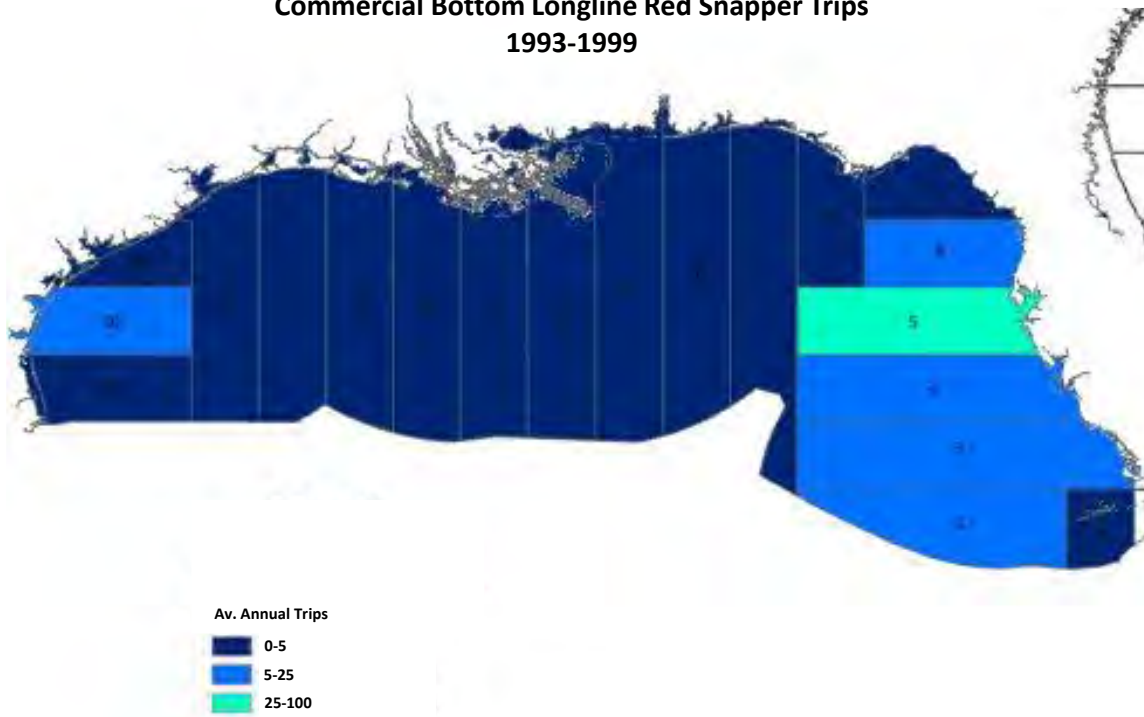
**Commercial Vertical Line Red Snapper Trips  
2014-2019**



**Figure 3.5.1:** Average annual red snapper trips for commercial vertical lines for four time periods: (A) 1993-1999, (B) 2000-2006, (C) 2007-2013, and (D) 2014-2019.

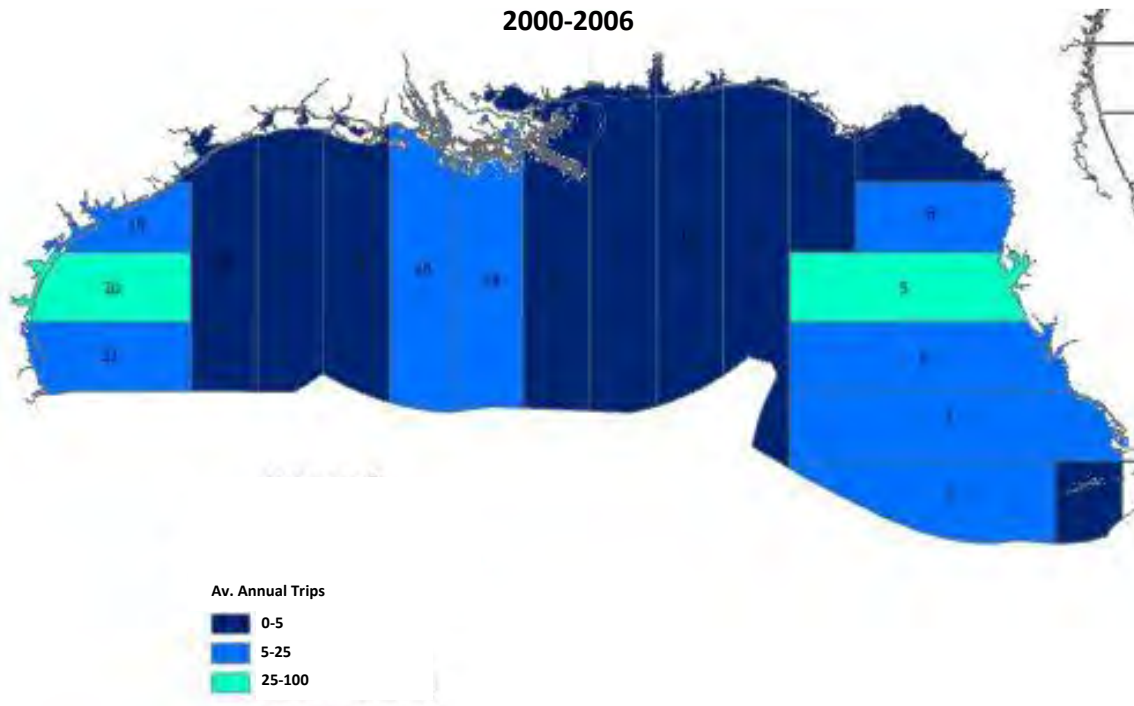
(A)

**Commercial Bottom Longline Red Snapper Trips  
1993-1999**



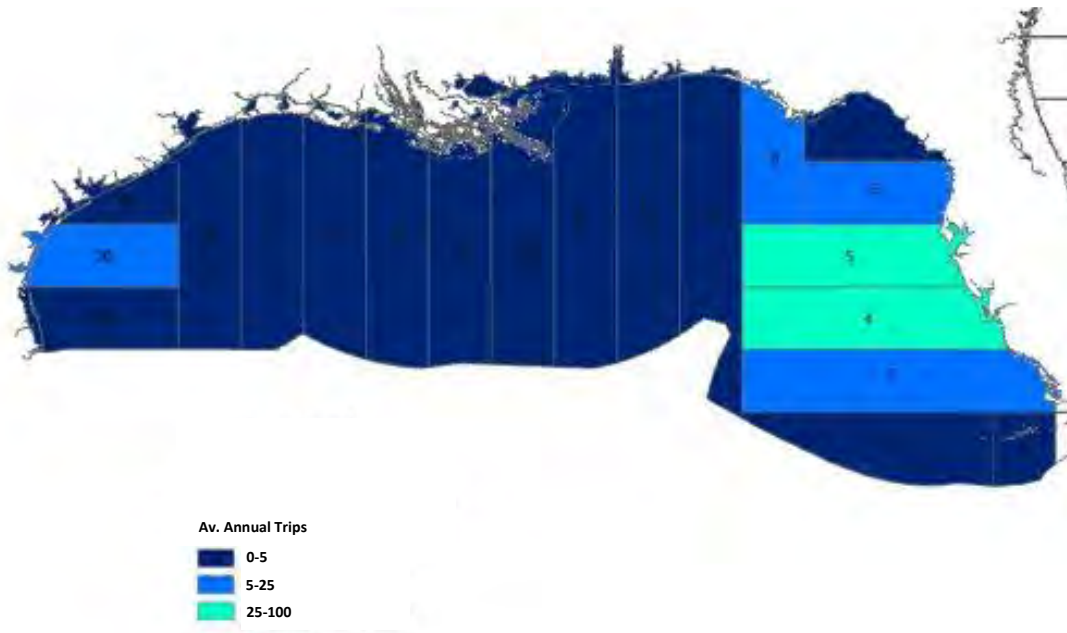
(B)

**Commercial Bottom Longline Red Snapper Trips  
2000-2006**



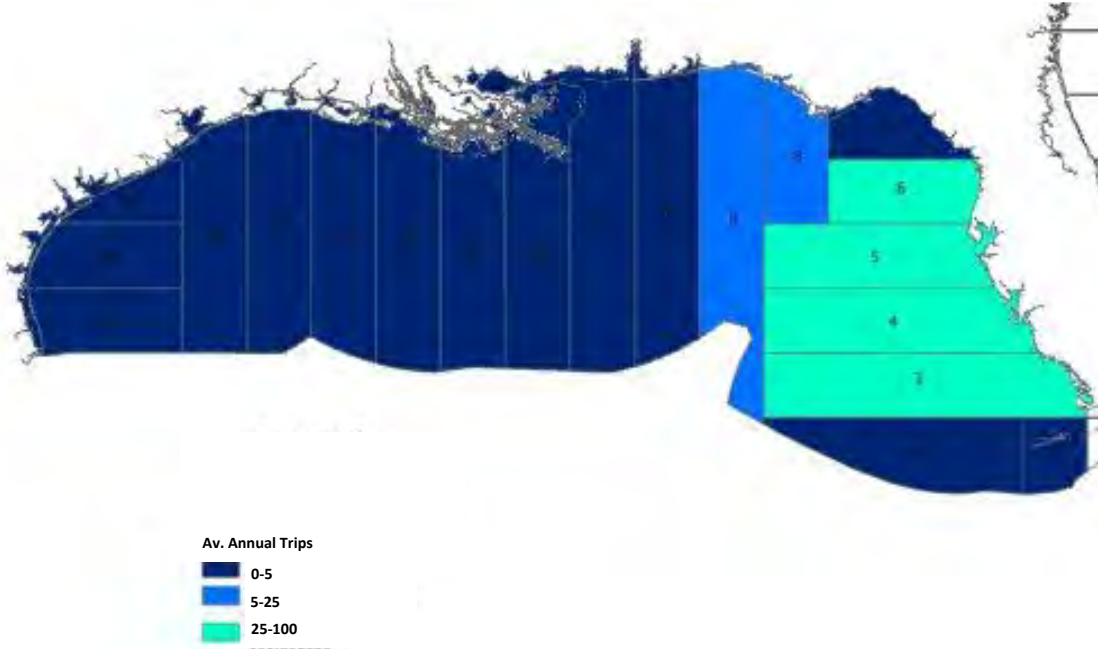
(C)

**Commercial Bottom Longline Red Snapper Trips  
2007-2013**

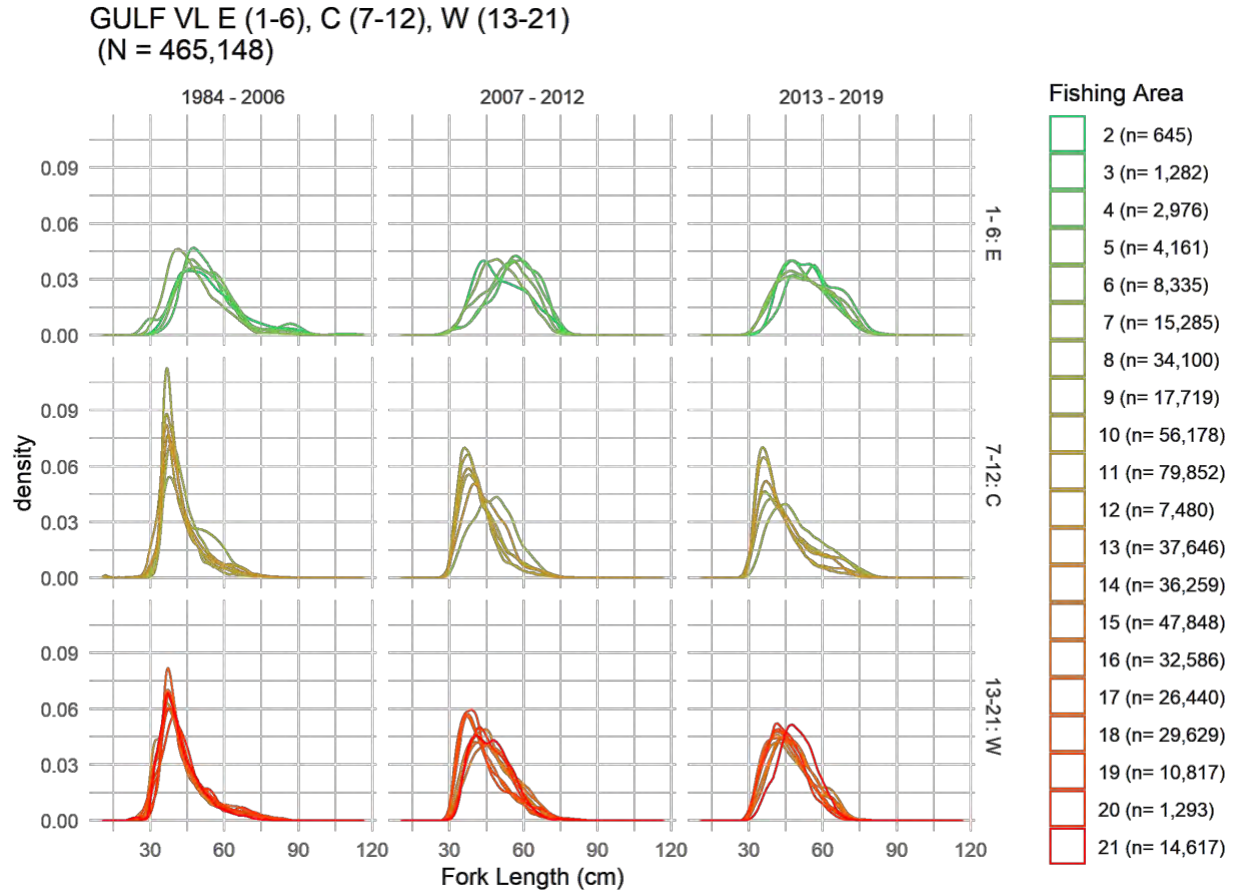


(D)

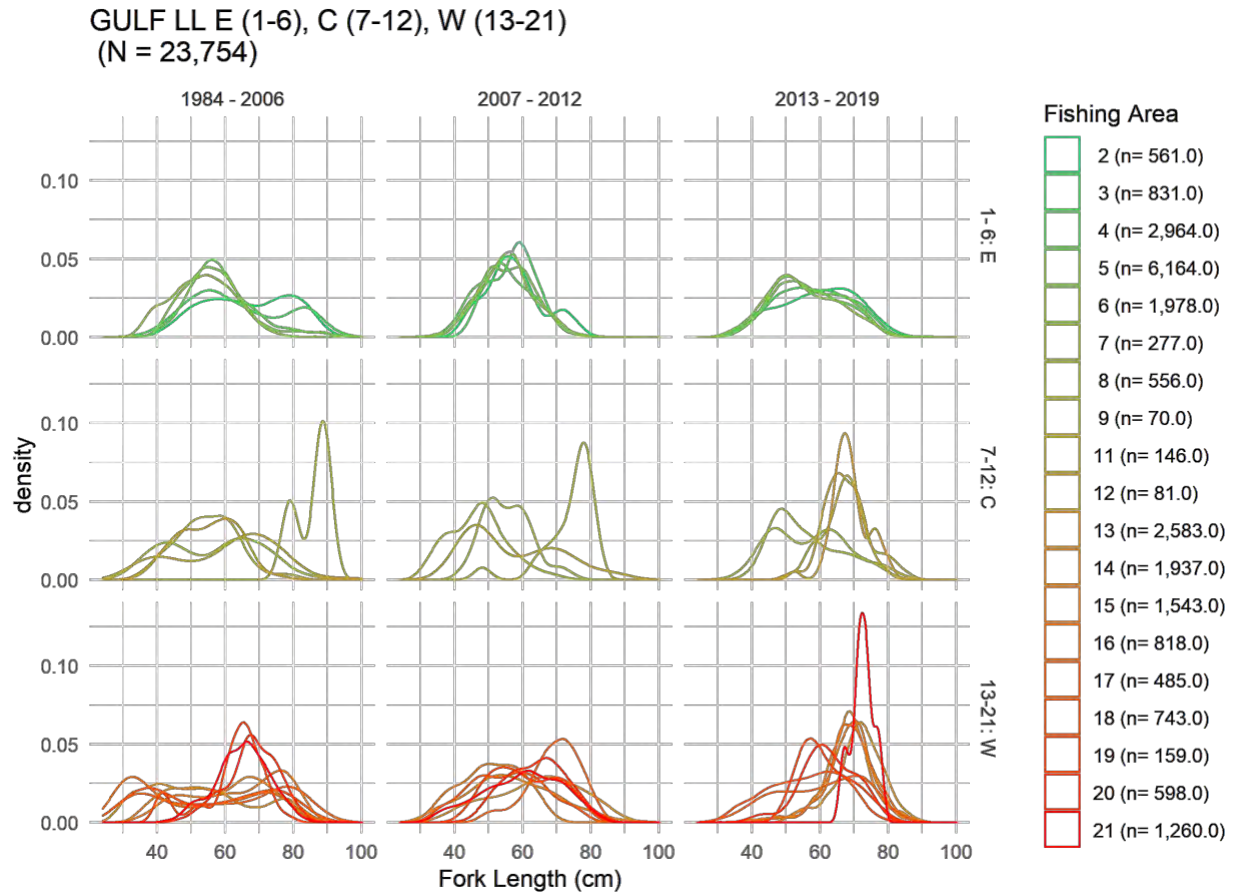
**Commercial Bottom Longline Red Snapper Trips  
2014-2019**



**Figure 3.5.2:** Average annual red snapper trips for commercial bottom longlines for four time periods: (A) 1993-1999, (B) 2000-2006, (C) 2007-2013, and (D) 2014-2019



**Figure 3.6.1**, Red snapper vertical line TIP length distributions in the finest spatial resolution possible for each stock (rows) and time period (columns) where green represents the easternmost fishing area and transitions to red in the west. 2007-2012 represents a time of rebuilding and is expected to have shifting compositions during the stock recovery.



**Figure 3.6.2,** Red snapper longline TIP length distributions in the finest spatial resolution possible for each stock (rows) and time period (columns) where green represents the easternmost fishing area and transitions to red in the west. Lower sample sizes for longline gear results in more sporadic length distributions.

## 4 RECREATIONAL FISHERY STATISTICS

### 4.1 OVERVIEW

#### 4.1.1 Group Membership

##### Leads

Ken Brennan- National Marine Fisheries Service (NMFS) Southeast Fisheries Science Center (SEFSC) Fisheries Statistics Division (FSD)

Vivian Matter- NMFS SEFSC Sustainable Fisheries Division (SFD)

##### Members

Jason Adriance- Louisiana Department of Wildlife and Fisheries (LDWF)

Donna Bellais- Gulf States Marine Fisheries Commission (GSMFC)

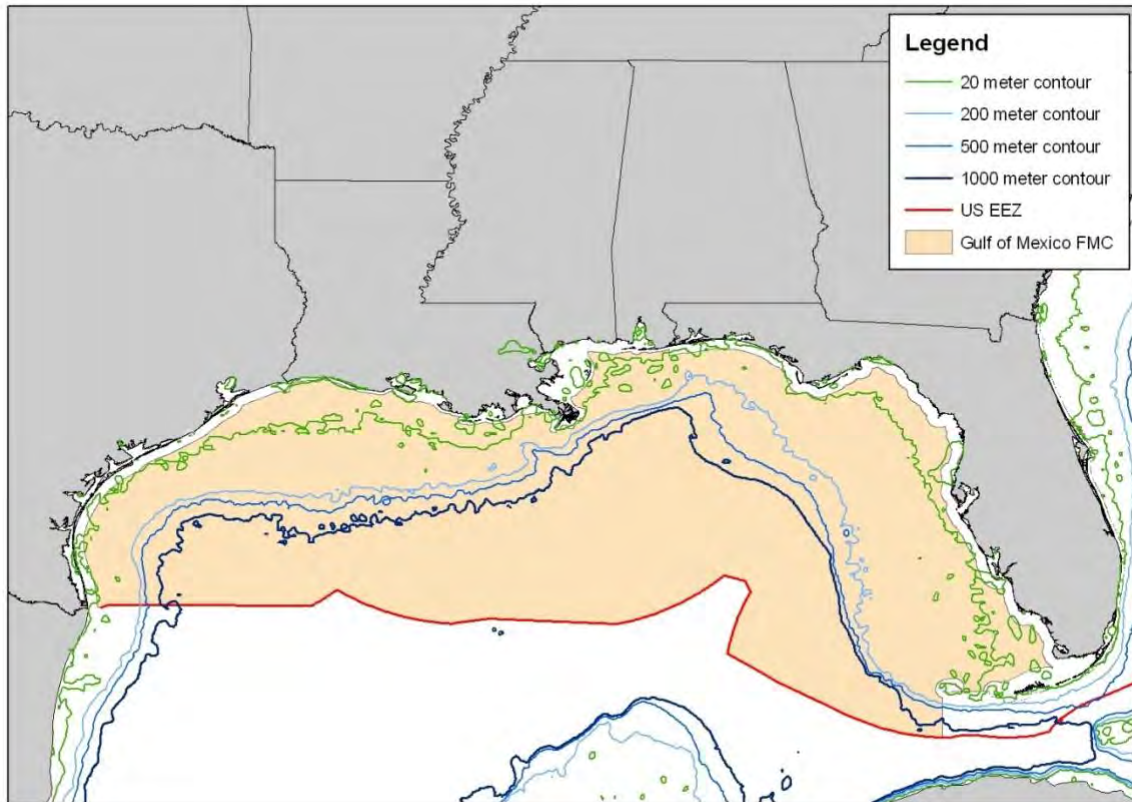
Susan Boggs- Gulf of Mexico Fisheries Management Council (GMFMC)  
 Rob Cheshire- NMFS SEFSC FSD  
 Troy Frady- GMFMC Appointee, Industry, AL  
 Michael Larkin- NMFS Southeast Regional Office (SERO)  
 Dominique Lazarre- Florida Fish and Wildlife Conservation Commission (FWCC)  
 John Marquez, Jr.- GMFMC Appointee, MS  
 Trevor Moncrief- Mississippi Department of Marine Resources (MDMR)  
 Craig Newton- Alabama Department of Conservation and Natural Resources (ADCNR)  
 Matthew Nuttall- NMFS SEFSC SFD  
 Beverly Sauls- FWCC  
 Eric Schmidt- Industry, FL  
 Steven Scyphers- Northeastern University (NEU)  
 Molly Stevens- NMFS SEFSC SFD  
 Jim Tolan- Texas Parks and Wildlife Department (TPWD)  
 Johnny Williams- Industry, TX

#### 4.1.2 *Tasks*

1. Summarize stock identification parameters
2. Review fully calibrated MRIP FES/APAIS/FHS landings and discard estimates
3. Allocate MRIP catch estimates from Monroe County to the Gulf of Mexico or South Atlantic
4. Evaluate MRIP catch estimates by mode of fishing to determine appropriate modes for inclusion in the Red Snapper assessment
5. Review calibrations of state survey estimates (TPWD and LA Creel) into MRIP-FES units
6. Evaluate usefulness of historical data sources such as the Fishing, Hunting, and Wildlife-Associated Recreation Survey (FHWAR) to generate estimates of landings prior to 1981
7. Provide estimates of uncertainty around each set of landings and discard estimates
8. Review whether SRHS discard estimates (2004+) are reliable for use and determine if there are other sources of data prior to the first reliable year that could be used as a proxy to estimate headboat discards back in time
9. Provide nominal length distributions for both landings and discards if feasible
10. Evaluate adequacy of available data
11. Provide research recommendations to improve recreational data

#### 4.1.3 *Gulf of Mexico Fishery Management Council Scamp Group Management Boundaries*





#### 4.1.4 Stock ID Recommendations

##### **Task 1:**

##### *Geographic Boundaries*

The SEDAR 74 Stock ID Workshop recommended three stock ID regions for Red Snapper. The Western region includes Texas and Louisiana. The Central region includes Mississippi, Alabama, and Northwest Florida, through SRHS area 23 and MRIP Florida sub-region 1 (Dixie County). The Eastern region includes Central and Southwest Florida (SRHS area 21 and MRIP Florida sub-regions 2 and 3 (Levy to Monroe Counties) (SEDAR 74 SID Report).

##### *Species Identification*

There were no species misidentification issues for SEDAR 74.

## 4.2 REVIEW OF WORKING PAPERS

### ***General Recreational Survey Data for Red Snapper in the Gulf of Mexico (SEDAR 74-DW-01)***

General recreational survey data for Red Snapper from the Marine Recreational Information Program (MRIP), Texas Parks and Wildlife Department (TPWD), and Louisiana Creel Survey (LA Creel) are summarized from 1981 to 2019 for Gulf of Mexico states from Texas to western Florida. Charter, Headboat, Private fishing modes are presented. These fully calibrated MRIP estimates take into account the change in the Fishing Effort Survey, the redesigned Access Point Angler Intercept Survey, and the For Hire Survey. Tables and figures presented include calibration comparisons, landing and discard estimates, associated CVs, sample sizes, fish sizes, and effort estimates.

#### ***LA Creel/MRIP Red Snapper Private Mode Landings and Discards Calibration Procedure (SEDAR 74-DW-04)***

Beginning in 2014, the Louisiana Department of Wildlife and Fisheries (LDWF) implemented its own creel survey (LA Creel) to provide recreational catch estimates for Louisiana-specific fishery management and stock assessment purposes. Prior to 2014, recreational catch estimates were taken from the National Marine Fisheries Service's Marine Recreational Intercept Program and the earlier Marine Recreational Fisheries Statistical Survey (NMFS MRIP/MRFSS). The MRIP and LA Creel surveys were conducted simultaneously in 2015 for benchmarking purposes. Methods were needed to calibrate Red Snapper landings and discards estimates to provide a time series of estimates for SEDAR 74 in common currencies from 1981-2020. A ratio estimator approach is used to hind cast LA Creel recreational landings and discards estimates to 1981 and the MRIP recreational landings and discards estimates to 2020. Tables and figures presented include calibration comparisons, landing and discard estimates in numbers of fish, and associated CVs for LA Creel estimates 2014+.

#### ***Florida State Reef Fish Survey Metadata (S74-DW-05)***

This paper briefly summarizes Florida's State Reef Fish Survey and the calibration of MRIP estimates to State Reef Fish Survey units from 1981 to 2015.

#### ***A description of Florida's Gulf Coast recreational fishery and release mortality estimates for the central and eastern sub-regions (Mississippi, Alabama, and Florida) (S74-DW-06)***

Sampling protocol specifics for each data collection are described below. All data are divided by fleet (charter, headboat, private) and region. Florida regions throughout this document are NWFL [Escambia to Levy counties (Federal SAC 7-10: contained within Central Gulf of Mexico stock)] and SWFL [Citrus to Monroe Counties (Federal SAC 1-6: encompassing the entire Eastern Gulf of Mexico stock)]. Alabama (AL) and Mississippi (MS) are each considered individually. This document contains data summaries describing the structure of the Florida recreational fishery (private and for-hire) along with estimates of proportional mortality by depth in each for-hire sector (headboats and charter boats) in four sub-regions (MS, AL, NWFL, SWFL). Projection estimates describing release mortality reductions possible in each fleet with several levels of descender device usage as a barotrauma mitigation method are also presented.

#### ***Size and age information for Red Snapper, *Lutjanus campechanus*, collected in association with fishery-dependent projects along Florida's Gulf of Mexico coast (S74-DW-07)***



The Fishery Dependent Monitoring subsection (FDM) of the Florida Fish and Wildlife Conservation Commission's Fish and Wildlife Research Institute (FWRI) monitors commercial and recreational fishing in marine environments along the Florida coast in association with several fishery-dependent research and monitoring projects. FDM administers two federal surveys, the Marine Recreational Information Program (MRIP) for the recreational sector and the Trip Interview Program (TIP) for the commercial sector. Additionally, FDM conducts several unique surveys of recreational anglers that allow for the collection of supplemental biological data. Each fishery-dependent research or monitoring project that contributed to the age and length data provided to the Life History Group is described below. Because fish must be returned to anglers quickly during fishery-dependent surveys, priority was given to collecting the left otolith if both otoliths could not be removed.

***Methodology Description for a Simple Ratio Calibration of Texas Private Boat Red Snapper Annual Landings Estimates (S74-DW-10)***

Annual estimates of private boat effort and Red Snapper landings are available from the Texas Parks and Wildlife Department (TPWD) Coastal Creel Surveys (CCS) program from 1983 to the present. The CCS design uses a fishing access site creel survey to estimate both catch and effort for the recreational private boat sector. This design differs from the multi-component complemented designs used by MRIP and other state surveys in the Gulf of Mexico Region. In 2016, the Marine Recreational Information Program (MRIP) conducted its Fishing Effort Survey (FES) in Texas (Papacostas and Foster, 2018; NOAA Fisheries, 2019) to produce effort estimates of private boat angler trips for comparison purposes. The difference between the TPWD and MRIP private boat effort estimates was large and significant (an order of magnitude), which is likely due at least in part by the exclusion of fishing from private access sites in the total effort estimates. A calibration ratio was proposed that could be used to create catch and effort estimates for Texas that would be more comparable to the corresponding MRIP estimates provided for the other Gulf States. Methods used to estimate variance for the ratio with a single year of benchmarking are also described.

***Evaluating Uncertainty in Gulf Red Snapper Estimates: A Preliminary Sensitivity Analysis of Non-Sampling Errors in the Region's Recreational Fishing Surveys (S74-DW-11)***

There are six different survey programs currently operating in the Gulf of Mexico to monitor the private boat recreational Red Snapper fishery: NOAA Fisheries' Marine Recreational Information Program (MRIP), which administers the Access Point Angler Intercept Survey (APAIS) and Fishing Effort Survey (FES; which replaced the Coastal Household Telephone Survey, or CHTS) in Mississippi, Alabama, and Florida; the Texas Coastal Creel Survey (CCS); Louisiana's LA Creel; Mississippi's Tails n' Scales; Alabama's Snapper Check; and Florida's State Reef Fish Survey (SRFS). Where programs overlap, systematic differences exist among estimates of Red Snapper catch. To date, we cannot definitively state why the estimates are different, other than they likely all suffer from differential levels of non-sampling error, or error that causes estimates to differ from the "true" removals (in this case, "true" Red Snapper

landings and discards). The direction and magnitude of these non-sampling errors are currently unknown. With this study, we begin investigating how non-sampling errors may influence the magnitude of the estimates derived from the different recreational Red Snapper monitoring programs in the region. This study also motivates and supports a collaborative research initiative in response to the Congressional directive from the 2021 House Committee on Appropriations to conduct an independent assessment of the surveys operating in the Gulf of Mexico and make recommendations for their improvement.

***SEFSC Computation of Uncertainty for General Recreational Landings-in-Weight Estimates, with Application to SEDAR 74 Gulf of Mexico Red Snapper (S74-DW-12)***

The Southeast Fisheries Science Center (SEFSC) routinely provides stock assessment analysts with estimates of recreational catch and associated measures of uncertainty. Such provision has traditionally focused on estimates of catch-in-number because numbers are the native units of recreational monitoring surveys and the traditional inputs into stock assessment models for the southeast region (SFD 2021a). However, additional inputs for the relative size of landed fish may also be needed to properly constrain assessment model predictions of landings-in-weight, as required by fishery managers to set annual catch limits (SFD 2021b). This working paper introduces two possible approaches by which uncertainty may be represented for landings-in-weight estimates in SEDAR stock assessments.

***Gulf of Mexico Red Snapper (*Lutjanus campechanus*) Commercial and Recreational Landings Length and Age Compositions (S74-DW-15)***

This document outlines the data and methodologies used to estimate nominal length and age compositions of commercial and recreational landings for the SEDAR 74 Gulf of Mexico Red Snapper Assessment. These compositions were estimated using data sources approved in SEDAR 52 and additional data sources will be considered at the Data Workshop. Following the SEDAR 74 Stock Identification workshop, the eastern stock was split near the previous boundary used to weight the length compositions (e.g. Big Bend region of Florida). Under this new structure, data are sparser in the Eastern and Central stocks (previously combined as Eastern). Therefore, this working paper outlines data availability and provides nominal compositions. At the Data Workshop, final methodologies for tracking cohorts in the assessment model will be determined.

***A Summary of Observer Data from the Size Distribution and Release Condition of Red Snapper Discards from Recreational Fishery Surveys in the Eastern Gulf of Mexico (SEDAR 74-DW-18)***

Detailed information on the size and release condition of discarded fish is not collected in traditional dockside surveys of recreational fisheries. At-sea observer surveys provide valuable information on the size and condition of discarded fish, and such surveys have been conducted on for-hire vessels in Florida since 2005. For-hire observer surveys have not been consistently funded in Florida, which has led to short breaks in the time series in some regions. In the first three years observer trips were only conducted on headboat vessels, and surveys were expanded

after 2008 to include both headboats and charter vessels across a larger geographic area. This report provides a summary of available information on the size composition, release condition, and disposition of Red Snapper collected by trained observers since 2005 during at-sea surveys on for-hire vessels in the eastern Gulf of Mexico.

### ***Gulf State Recreational Catch and Effort Surveys Transition Workshop Summary Report (S74-DW-29)***

This draft report summarizes the results of a virtual meeting, held Feb. 23-25, 2022, to address critical short and long-term needs necessary to move towards full transition of the use of data from various certified recreational fishing surveys in regional stock assessments in the Gulf of Mexico. It represents the latest in a series of meetings that have addressed the issue of comparability of alternative estimates. Upcoming assessments for Gag Grouper and Red Snapper in the Gulf create additional urgency for this task. This report is the proceedings of that meeting, summarizes presentations and the ensuing discussions and recommendations. More than 100 individuals attended the meeting and 50 participated directly in the discussions. Notably, five expert statistical consultants provided recommendations in response to presentations, questions, and discussions during the meeting. In addition, the Consultants met after the meeting to craft more synthetic responses to the suite of meeting topics. Their findings are included as an appendix to clearly distinguish topics that were addressed in plenary session from those that were addressed outside the meeting.

## 4.3 RECREATIONAL DATA SOURCES

### *4.3.1 Marine Recreational Information Program (MRIP)*

#### *Introduction*

The Marine Recreational Information Program (MRIP), formerly the Marine Recreational Fisheries Statistics Survey, conducted by NOAA Fisheries (NMFS) provides estimates of catch per unit effort, total effort, landings, and discards for six two-month periods (waves) each year. MRIP provides estimates for three main recreational fishing modes: shore-based fishing (Shore), private and rental boat fishing (Priv), and for-hire charter and guide fishing (Cbt). MRIP also provides estimates for headboat mode (Hbt) in the mid and north Atlantic regions. MRIP covers all Gulf of Mexico states from western Florida to Mississippi. Louisiana was covered by the survey until 2014 and Texas is not covered to avoid overlap with the TPWD survey (discussed below in 4.3.2). When the survey first began in Wave 2 (Mar/Apr) of 1981, headboats were included in the for-hire mode, but were excluded after 1985 to avoid overlap with the Southeast Region Headboat Survey (SRHS), conducted by the NMFS Beaufort laboratory.

Recreational catch, effort, and participation were estimated through a suite of independent but complementary surveys that are described in SEDAR 68-DW-13. Over the years, effort data have been collected from three different surveys: (1) the Coastal Household Telephone Survey

(CHTS) which used random digit dialing of coastal households to obtain information about recreational fishing trips, (2) the weekly For-Hire Survey which interviews charterboat operators (captains or owners) to obtain trip information and replaced the CHTS for the charter mode (in 2000 for the Gulf of Mexico and East Florida and 2004 for the Atlantic coast north of Georgia), and (3) the Fishing Effort Survey which is a mail based survey whose sample frame consists of anglers from the National Saltwater Angler Registry and replaced the CHTS for the private and shore modes in 2018. Catch data are collected through dockside angler interviews in the Access Point Angler Intercept Survey (APAIS), which samples recreational fishing trips after they have been completed. In 2013, MRIP implemented a new APAIS to remove sources of potential bias from the sampling process. Catch rates from dockside intercept surveys are combined with estimates of effort to estimate total landings and discards by wave, mode, and area fished (inland, state, and federal waters).

Catch estimates from early years of the survey are highly variable with high proportional standard errors (PSE's), and sample sizes in the dockside intercept portion have been increased over time to improve precision of catch estimates. Several quality assurance and quality control improvements were implemented for the intercept surveys in 1990. Prior to 1990 the contractor did not have regional representatives hired to supervise the samplers in any given area. All samplers were hired as independent sub-contractors and communicated directly with the contractor's home office staff. It is much more likely that the samplers who worked in the 80's would have varied more in their interpretation of sampling protocols and their ability to identify at least some of the more difficult-to-recognize species. There were a number of other changes made to enhance consistency in sampling protocols and improve error-checking in the Statement of Work for the 1990-1992 contracts. Improvements have continued over the years, but the biggest changes happened at that time (personal communication, NMFS). Catch rate data have improved through increased sample quotas and additional sampling (requested and funded by the states) to the intercept portion of the survey.

**Task 2:** In order to maintain a consistent time series, charter estimates were calibrated on the Gulf coast prior to 2000 (SEDAR64-RD-12). CHTS and calibrated FHS charter catch estimates for Gulf of Mexico Red Snapper from 1981 to 1999 are shown in Figure 1 of SEDAR 74-DW-01. Calibrated APAIS and FES estimates for Gulf of Mexico Red Snapper from 1981 to 2019 are shown in Figure 2 of SEDAR 74-DW-01.

### *Monroe County*

Monroe County MRIP landings are included in the official West Florida estimates. However, they can be estimated separately using domain estimation. The Monroe County domain includes only intercepted trips returning to that county as identified in the intercept survey data. Estimates are then calculated within this domain using standard design-based estimation which incorporates the MRIP design stratification, clustering, and sample weights (SEDAR68-DW-13). Although Monroe County estimates can be separated using this process, they cannot be

partitioned into those from the Atlantic Ocean and those from the Gulf of Mexico (SEDAR-PW-07).

**Task 3:** For SEDAR 74, MRIP Red Snapper landings from Monroe County were allocated to the Gulf of Mexico because Red Snapper are less common on the extreme south Atlantic coast of Florida. This recommendation is in agreement with previous Gulf of Mexico (SEDAR 31 and 52) and South Atlantic (SEDAR 24 and 41) Red Snapper assessments.

#### *Adjustment to Fishing Modes*

**Task 4a:** Between 1981 and 1985, MRIP charter and headboat modes were combined into a single mode for estimation purposes. Since the NMFS Southeast Region Headboat Survey (SRHS) began in the Gulf in 1986, the MRIP combined charter/headboat mode must be split in order to provide estimates of headboat landings in these early years. The MRIP charter/headboat mode (1981-1985) was split by using a ratio of SRHS headboat angler trip estimates to MRIP charterboat angler trip estimates for 1986-1990. In accordance with SEDAR Best Practices, the mean ratio was calculated by state (or state equivalent to match SRHS areas to MRIP states) and then applied to the 1981-1985 estimates to split out the headboat component when needed (SEDAR-PW-07). The MRIP headboat component from this split was used to represent headboat fishing in the Gulf (Louisiana to western Florida) from 1981-1985 and SRHS headboat estimates for all years after 1985.

**Task 4b:** The Recreational Working Group also discussed the validity of the MRIP shore mode estimates for Gulf of Mexico Red Snapper. The Group recommended that all shore mode estimates be excluded because Red Snapper is an offshore species with a strong association with reefs and hard bottoms, and unlikely to be caught from shore (SEDAR 31-DW-04). This recommendation is in agreement with decisions made during SEDAR 31 and 52.

#### *Uncertainty*

Coefficient of variation (CV) estimates for Marine Recreational Information Program (MRIP) survey catch totals are provided for stock assessments by the Southeast Fisheries Science Center (SEFSC). Variances of total catch estimates are computed directly from the raw survey data to obtain CVs appropriate for custom aggregations by year, wave, sub-region, state, and mode using standard survey methods (SEDAR 68-DW-10).

#### *4.3.2 Louisiana Creel Survey (LA Creel)*

The Louisiana Department of Wildlife and Fisheries (LDWF) began conducting the Louisiana Creel (LA Creel) survey program on January 1, 2014 to monitor marine recreational fishery

catch and effort. Private and charter modes of fishing are sampled. The program is comprised of three separate surveys: a shore side intercept survey, a private telephone survey, and a for-hire telephone survey. The shore side survey is used to collect data needed to estimate the mean numbers of fish landed by species for each of five different inshore basins and one offshore area. The private telephone survey samples from a list of people who possess either a LA fishing license or a LA offshore fishing permit and provided a valid telephone number. The for-hire telephone survey samples from a list of Louisiana's registered for-hire captains who provided a valid telephone number. Both telephone surveys are conducted weekly. Discard information has been collected since 2016 but only for a subset of finfish species.

### **Task 5a:**

#### *Calibration to MRIP FES units*

The MRIP and LA Creel surveys were conducted simultaneously in 2015 for benchmarking purposes. A ratio estimator is used to calibrate private mode LA Creel landings and discards in numbers of fish to MRIP FES units. Because the charter fishing frame used by the LA Creel and MRIP surveys are functionally equivalent, charter fishing estimates of the two surveys are assumed equivalent and are not adjusted. The ratio of the 2015 private mode landings estimates from the LA Creel and MRIP FES surveys is used to calibrate private LA Creel landings (2014, 2016-2020) to MRIP FES units as the product of the 2015 MRIP/LA Creel landings ratio and the annual LA Creel landings estimates. Discard estimates between surveys are calibrated using the same methodology as landings (SEDAR 74-DW-04). Effort calibrations were provided by using a ratio estimator of annual 2015 effort estimates from each survey for the private fishing mode.

#### *Uncertainty*

Coefficients of variation for annual LA Creel landings and discards estimates are provided by the LDWF. Variances are calculated from the survey data for each week of year, area, and fishing mode and are summed to estimate annual CV's of landings and discards. These variances, in LA Creel units, are then scaled into MRIP-FES units using a Taylor Series expansion that assumes the MRIP and LA Creel point estimates are independent (i.e., correlation = 0). This is the same approach used to calibrate the TPWD time series into MRIP-FES units, and is outlined in SEDAR 74-DW-10.

### *4.3.3 Texas Parks and Wildlife Department's (TPWD) Marine Sport-Harvest Monitoring Program*

The TPWD Sport-Boat Angling Survey samples fishing trips made by sport-boat anglers fishing in Texas marine waters. All sampling takes place at recreational boat access sites. The raw data include information on catch, effort, and length composition of the catch for sampled boat-trips. These data are used by TPWD to generate recreational catch and effort estimates starting in May

1983 (SEDAR 70-WP-03). The survey is designed to estimate landings and effort by high-use (May 15-November 20) and low-use seasons (November 21-May 14). Since SEDAR 16 in 2008, SEFSC personnel have disaggregated the TPWD seasonal estimates into waves (2-month periods) using the TPWD intercept data. This was done to make the TPWD time series compatible with the MRIP time series. TPWD surveys private and charter boat fishing trips. While TPWD samples all trips (private, charter boat, ocean, bay/pass), most of the sampled trips are associated with private boats fishing in bay/pass areas as these trips represent most of the fishing effort. Charter boat trips in ocean waters are the least encountered by the survey. Additional information on the TPWD survey can be found in SEDAR 70-WP-03.

### **Task 5b:**

#### *Calibration to MRIP FES units*

The MRIP-FES survey was implemented in Texas in 2016 (S74-RD-110) to compare MRIP-FES effort estimates with the associated estimates from the TPWD survey. A ratio estimator was calculated from these two sets of estimates and reviewed during the data workshop for SEDAR 74. This calibration is described in SEDAR 74-DW-10 and may be applied to landings, discards, and effort estimates to calibrate private TPWD estimates into MRIP-FES units. The MRIP-FES has never been conducted in Texas and so an appropriate TPWD-MRIP calibration for the Texas charter mode is not available.

The Recreational Working Group evaluated the proposed calibration and considered two options for Texas estimates.

- Option 1: Use uncalibrated Texas estimates in TPWD units
  - Pros:
    - Consistent with how TPWD was used in previous assessments
  - Cons:
    - TPWD estimates as reported by the survey are not comparable in scale to the estimates generated by the other Gulf States.
    - Texas estimates would not be in the same units as the other Gulf States, leading to geographically disparate stock assessment inputs.
    - Does not address evidence from other sources (angler input, SRHS, USFWS 2011 Texas FHWAR) that suggest the Texas landings are underestimated.
- Option 2: Use calibrated Texas estimates to MRIP-FES units
  - Pros:
    - Generates estimates comparable in units as the other Gulf states
  - Cons:
    - Based on one year of overlap in effort data between the FES and TPWD.
    - Effort estimates by wave in the 2016 study did not reflect the expected effort distribution.

- Only available for private mode effort. No APAIS intercept survey conducted.
- Large variance associated with calibration ratio.

Given the two less than optimal options provided, the group recommended adjusting the private TPWD estimates to MRIP FES (SEDAR 74-DW-10). This comes with a strong recommendation to also prioritize the following three research recommendations:

- SSC to add TOR to operational assessment to include a topical working group to review and evaluate the results of the Gulf of Mexico transition plan to optimize the use of state and federal data.
- Integrate TPWD into the Gulf Transition Team in order to further evaluate the proposed calibration between TPWD and MRIP units and identify alternative methods that may be implemented, including increased benchmarking (e.g. 3-year benchmark period).
- Gulf Transition Team should investigate the drivers of high MRIP wave specific effort estimates for recreational modes during traditionally low effort waves (e.g. winter waves, particularly in MS).

### *Uncertainty*

Standard errors of landings are provided by TPWD. The variances, in TPWD units, are then scaled into MRIP-FES units using a Taylor Series expansion that assumes the MRIP and TPWD point estimates are independent (i.e., correlation = 0). This approach is described in SEDAR 74-DW-10.

#### *4.3.4 Southeast Region Headboat Survey (SRHS)*

The Southeast Region Headboat Survey (SRHS) estimates landings and effort for headboats in the South Atlantic and Gulf of Mexico. The SRHS incorporates two components for estimating catch and effort. 1) Information about the size of fish landed is collected by port samplers during dockside sampling, where fish are measured to the nearest mm and weighed to the nearest 0.01 kg. These data are used to generate mean weights for all species by area and month. Port samplers also collect otoliths for ageing studies during dockside sampling events. 2) Information about total catch (landings and discards) and effort are collected via the logbook, an electronic form filled out by vessel personnel and containing total catch and effort data for individual trips. These logbooks are summarized by vessel to generate estimated landings by species, area, and time strata.

The SRHS was started in 1972 but only included vessels from North Carolina and South Carolina. In 1975, the survey was expanded to northeast Florida (Nassau-Indian River counties), followed by Georgia in 1976 and southeast Florida (St. Lucie-Monroe counties) in 1978. In



1986, the survey expanded to include west Florida, Alabama, Louisiana, and Texas. Mississippi was added to the survey in 2010. For SEDAR 74, only data from West Florida through Texas were included. Due to headboat area stock ID boundaries and confidentiality issues, estimates of SRHS catch are combined for Louisiana and Texas for the West Region, Mississippi with Alabama and Northwest Florida for the Central Region, and Southwest Florida for the East Region. The portion of the SRHS covering the Gulf States generally includes 65-70 vessels participating annually.

#### *Texas Headboat Landings (1981-1985)*

Landings estimates for Gulf of Mexico headboats between 1981 and 1985 come from the MRIP survey for all states except Texas. As in previous SEDARs, Texas headboat landings for 1981 to 1985 were estimated as a three-year average (1986-1988) from SRHS Texas headboat landings.

#### *Uncertainty*

The SRHS is designed to be a census and so reporting compliance and accuracy are the primary components of the uncertainty in landings and discard estimates over time. Headboat activity is monitored by port agents to validate trips. A quantitative method to describe the uncertainty in estimates from the SRHS was developed in SEDAR 68 (SEDAR68-DW-31). This method estimates uncertainty from the variance in industry-reported (logbook) catch data at the vessel, area, and month strata and applies a finite population correction factor to account for non-reporting of headboat fishing activity, the calculation of which is a function of the reported and estimated number of compliant vessels. The resulting CV estimates for scamp in SEDAR 68 averaged 0.03 over the entire time series, including those early years wherein only approximately 60% of the vessels submitted logbooks. In recent years, the CV for scamp was estimated to be 0 due to full compliance in reporting vessels and does not account for any potential errors in reporting, even though these are likely to be small. Additionally, the method applied in SEDAR 68 does not consider the duration of the trip in the variance estimates for catch. It is possible that outliers from multi-day trips could inflate the variance for more common species.

Given these concerns, two other options were considered in this assessment to describe uncertainty that are not based on variance in catch and include a buffer of 0.05 to the CV across all years to account for uncertainty in the reported values (i.e., misreporting). The first of these approaches used annual proportions of reported to estimated counts of active vessels reporting catch (fully or partially) by year, area, and month, which is equivalent to the compliance rate metric in the SEDAR 68 method. The second approach applies the annual proportions of reported to estimated trips by region as a proxy for CV.

The second method was chosen to be applied in SEDAR 74 because it is based on the number of fishing trips missing an associated logbook submission (i.e., unreported). The first method, conversely, applies a correction based on a fraction of non-compliant vessels, and so is believed

to provide a less accurate correction to trip-level catch. The associated CV from the chosen approach (#2) is estimated from:

$$CV = 1 - \frac{n}{N} + 0.05$$

where  $n$  is the number of reported trips and  $N$  is the number of estimated trips. This method balances conflicting biases in uncertainty. Methodologies to account for catch from unreported trips leverage information from similar vessels, months, areas, and trip types and are likely to decrease our estimate of uncertainty. However, the quality of reporting from compliant vessels is likely to have improved over time which would suggest these uncertainty estimates are low.

#### 4.3.5 Headboat At-Sea Observer Survey

An observer survey of the recreational headboat fishery was launched in AL in 2004 and in FL in 2005 to collect more detailed information on recreational headboat catch, particularly for discarded fish. Sampling in both states was discontinued in 2008, but was started again along western FL in June 2009, with coverage expanded to also include the charterboat fleet. Since 2009, spatial and temporal coverage along the west coast of FL has been variable (Table 1, SEDAR 74-DW-18); however, this will improve in the future as stable state funding was recently secured. Cooperative headboat and charterboat vessels were randomly selected each month throughout the year. Biologists board selected vessels with permission from the captain and observe anglers as they fish on the recreational trip. Data collected include the species, number, final disposition, and size of landed and discarded fish. Data are also collected on the length of the trip and area fished (inland, state, and federal waters) (SEDAR 74-DW-18).

### 4.4 RECREATIONAL LANDINGS

#### 4.4.1 MRIP Landings

##### *Weight Estimation*

The Southeast Fisheries Science Center used the MRIP, LA BIO, and TPWD sample data to obtain an average weight by strata using the following hierarchy: species, region, year, state, mode, wave, and area (SEDAR32-DW-02). The minimum number of weights used at each level of substitution is 15 fish, except for the final species level where the minimum is 1 fish (SEDAR67-WP-06). Average weights are then multiplied by the landings estimates in numbers to obtain estimates of landings in weight. These estimates are provided in pounds whole weight.

Two approaches for calculating the uncertainty around the landings-in-weight are presented in SEDAR 74-DW-12. The first approach is a modification to the method used to calculate catch-in-number CVs and assumes average weights are constants adding no additional uncertainty. The second approach adds the variability of the raw size data used to calculate recreational landings-

in-weight estimates. Briefly, all observations of fish weight are averaged at the trip level, from which the mean and standard error of these trip-level summaries are calculated at the same strata used in SEFSC weight estimation (e.g., *syrsmwa*), combined to the year/mode level (e.g., year and mode), and converted to coefficients of variation (CV). These uncertainty estimates for SEFSC average weights are then combined with those for landings-in-number (Goodman 1960) as an uncertainty estimate for landings-in-weight. The Recreational Working Group recommended using the second approach for calculating uncertainty around average (fish) weight and landings-in-weight estimates.

#### *Catch Estimates*

Final MRIP landings estimates and associated coefficients of variation, in numbers of fish, are shown by year and mode in Table 3 of SEDAR 74-DW-01 and by year in Table 5 of SEDAR 74-DW-01. Estimates are provided for all Gulf of Mexico states from Louisiana to western Florida. Final MRIP landings estimates in pounds whole weight are shown by year and state in Table 6 of SEDAR 74-DW-01.

#### *4.4.2 LA Creel Landings*

Starting in 2014, recreational data for Louisiana are only available from the LA Creel survey. LA Creel landings estimates, calibrated to MRIP FES units for Louisiana Red Snapper (2014-2019) are provided in Table 1 of SEDAR 74-DW-04. These landings-in-number estimates are then multiplied by the corresponding SEFSC average weights to estimate landings-in-weight. Uncertainties for average weight and landings-in-weight are calculated using the same approach described above for MRIP (approach 2 in SEDAR 74-DW-12).

#### *4.4.3 TPWD Landings*

TPWD average estimates from 1983 to 1985 (by wave and mode) were used to fill in the missing estimates for Texas charter and private boat fishing from 1981 until the survey started in May 1983. TPWD Red Snapper landings-in-number estimates, calibrated to MRIP FES units for the private mode, from 1981 to 2019 are provided in Table 4.12.1. These landings-in-number estimates are then multiplied by the corresponding SEFSC average weights to estimate landings-in-weight. Uncertainties for average weight and landings-in-weight are calculated using the same approach described above for MRIP (approach 2 in SEDAR 74-DW-12).

#### *4.4.4 SRHS Headboat Logbook Landings*

Final SRHS landings estimates (in number and weight) by stock ID region are shown in Table 4.12.2. CVs are provided for landings estimates in number of fish and can be used as a proxy for uncertainty of estimates in weight. This would assume there is no additional uncertainty from the average weights calculated from the SRHS dockside biological sampling. CVs average 0.33,

0.45, and 0.56 across the first 5 years of the SRHS (1986-1990) for the West, Central, and East regions respectively and all decrease to near 0.05 in recent years.

#### 4.4.5 *Historic Recreational Landings*

##### *Introduction*

The historic recreational landings time period is defined as pre-1981 for the charter, headboat, private fishing modes, which represents the start of the Marine Recreational Information Program (MRIP) and availability of landings estimates for Red Snapper. The Recreational Working Group was tasked with evaluating historical sources and methods to compile landings estimates for Red Snapper prior to 1981.

##### *FHWAR Census Method*

The 2001 National Survey of Fishing, Hunting, and Wildlife-Associated Recreation (FHWAR) presents summary tables of U.S. population estimates, along with estimates of hunting and fishing participation and effort from surveys conducted by the US Fish and Wildlife Service every 5 years from 1955 to 1985 (SEDAR 68-DW-11). This information was used to develop an alternative method for estimating recreational landings prior to 1981. The two key components from these FHWAR surveys that were used in this census method were the estimates of U.S. saltwater anglers and U.S. saltwater days. These estimates are used to calculate the historical effort of Gulf of Mexico saltwater anglers. The mean CPUE from the recreational estimates available beginning in 1981 can then be applied to the historical effort estimates for Gulf of Mexico anglers to provide estimates of recreational Red Snapper landings prior to 1981.

**Task 6:** Estimate historical Red Snapper landings prior to 1981

- Option 1: Calculate historical Red Snapper landings from the FHWAR method using mean CPUE from the recreational estimates from **1981-1985** MRIP, SRHS, TPWD, and LA Creel surveys.
- Option 2: Calculate historical Red Snapper landings from the FHWAR method using mean CPUE from the recreational estimates from **1981-1989** MRIP, SRHS, TPWD, and LA Creel surveys (Figure 4.13.1).
- Option 3: Do not estimate historical Red Snapper landings estimates prior to 1981.

The SEDAR 74 Recreational Working Group recommended calculating historical landings estimates from the FHWAR method using the mean CPUE from 1981 to 1989 (Option 2). This longer time period mitigates the higher variability in the MRIP catch estimates from early years of the survey described in section 4.3.1. Further, this time period represents a generally unregulated fishery characteristic of the Red Snapper fishery prior to 1981, during which there were no bag limits. Additionally, size restrictions generally had little effect on recreational fishing. Although the 12" size limit was implemented in November of 1984, headboats were exempted from that size restriction until 1986 and recreational anglers could keep up to 5 fish below the size limit (SEDAR 74-DW-25). There was also generally low enforcement of

regulations during this time period. For these reasons, the Recreational Working Group recommended the mean CPUE from 1981-1989.

The Recreational Working Group was asked by assessment analysts to partition historical landings back in time by fishing mode and stock region. This was accomplished by calculating the mean ratio of recreational landings by mode and stock region from 1981-1989. These mean ratios are then applied to the historical landings from 1980-1955. The RWG discussed the change in the recreational fishing fleet composition back in time. This included firsthand personal accounts by headboat and charter boat captains, who indicated a higher prevalence of charter and headboat fishing in the 1950s and 1960s. It was also noted that there was an increase in the availability and affordability of boats for private anglers to fish offshore from 1955 to 1980 and an increase in population on the coast which led to an increase in potential private boat owners and anglers.

Based on these accounts and the lack of navigational and technological aids available to private recreational anglers fishing for Red Snapper in the past, it was agreed that the relative proportion of private landings would decrease back in time, while the relative proportion of for-hire landings would have increased. The RWG discussed how to adjust for this change, and recommended the following proposed method for partitioning the historical landings estimates back in time by region and stock:

- Assume the same geographic proportions of West, Central, and East Gulf as there was no evidence presented during discussions contradicting these ratios back to 1955.
- Apply mean ratio of recreational landings by mode and stock region from 1981-1989 to the time period 1975 to 1980 (Table 4.12.3). During this time period Loran C became more prevalent and affordable to private anglers.
- Approximate the relative proportion of landings by mode within each stock ID region prior to 1975 taking into account technological changes that influenced the prevalence of private and for-hire fishing (Table 4.12.3 and Figure 4.13.2).
  - 1965 -1974 - Loran A is mostly used by commercial and for-hire vessels; advent of Loran C
  - 1955 - 1964 - Limited availability of Loran A (military surplus) some being used as means for navigation by commercial and for-hire fishing vessels. Very limited for private anglers.

Historical Red Snapper estimates in number of fish are shown in Table 4.12.4 by stock ID and mode. Historical landings estimates in pounds whole weight were calculated by using the average weight from 1981-1989 by mode and stock ID region for the same time periods. These average weights were applied to the landings in number by mode, stock ID region and time periods. Historical Red Snapper landings estimates in pounds are shown in Table 4.12.5.

### *Uncertainty*

CVs calculated using the FHWAR method for total recreational landings is 0.86. Since these estimates were further partitioned into stock ID and mode, the Recreational Working Group recommended increasing the uncertainty for the historical estimates (in number and weight) by stock region and mode to 1.0. These regional and mode specific estimates are highly uncertain given the limited information available to describe the fisheries back in time.

#### 4.4.6 Total Recreational Landings

Combined landings estimates (MRIP, SRHS, TPWD, and LA Creel) by year, mode, and stock ID for 1981-2019 are shown in Tables 4.12.6- 4.12.8, Figure 4.13.3, and mapped in Figure 4.13.4.

### 4.5 RECREATIONAL DISCARDS

#### 4.5.1 MRIP Discards

Fish reported to have been discarded alive are not seen by MRIP interviewers and so neither the identity nor the quantities of discarded fish can be verified. The size and weight of discarded fish are also unknown for all modes of fishing. MRIP discard estimates and associated coefficients of variation, in numbers of fish, are shown by year and mode in Table 4 of SEDAR 74-DW-01 and by year in Table 5 of SEDAR 74-DW-01. Estimates are provided for all Gulf of Mexico states from Louisiana to western Florida.

#### 4.5.2 LA Creel Discards

Red Snapper are a target species of the LA Creel survey and discard estimates are available starting in 2016. LA Creel discard estimates of Red Snapper in 2014 and 2015 are imputed as the product of the ratio of annual discards to harvest in the 2016 LA Creel survey (Table 2, SEDAR 74-DW-04) and the 2014 and 2015 LA Creel harvest estimates. The 2016 LA Creel estimates were chosen to form the ratio of discards to harvest to calculate the 2014 and 2015 LA Creel discards estimates due to the similarity between the 2014-2016 Louisiana Red Snapper fishing seasons (i.e., similar federal and state season lengths) prior to fishery management changes implemented in 2017. Private mode LA Creel discard estimates, calibrated to MRIP FES units for Louisiana Red Snapper (2014-2019) are provided in Table 3 of SEDAR 74-DW-04.

#### 4.5.3 TPWD Discards

Self-reported catch is not monitored by the TPWD survey and so discards of Red Snapper from Texas are not estimable from this survey (SEDAR 70-WP-03). As a proxy for recreational discards from Texas private and charter boat anglers, discard: landings ratios (B2:AB1) are calculated (by year and mode) from Louisiana catch estimates and multiplied by TPWD landings estimates. TPWD estimates of Red Snapper discards, calibrated to MRIP-FES units for the

private mode, from Texas (1981-2019) are provided in Table 4.12.9. It should be noted that Red Snapper harvest is open year-round in Texas state waters and discarding in Louisiana is likely not representative of the entire western region. However, this is the only method currently available to estimate discards in Texas.

#### 4.5.4 Headboat At-Sea Observer Survey Discards

Self-reported headboat discards (discussed in 4.5.5) are not currently validated within the SRHS. However, discard information from the At-Sea Observer Survey is used to validate the SRHS discard estimates and determine whether SRHS discards should be used for the entire time series (2004-2019) or for a partial time series. In the Gulf of Mexico, the At-Sea Observer Survey operates mainly in western Florida, with limited coverage in Alabama in certain years. No trips were sampled in the At-Sea Observer Survey in 2008. During SEDAR 52 the SRHS discard proportions were compared to the MRIP At-Sea Observer program discard proportions for validation purposes and to determine whether the SRHS discard estimates should be used for a full or partial time series (SEDAR 52- DW-21). Based on those findings and the updated discard estimates it was determined that the SRHS discard estimates should be used for a partial time series (2008-2019), while using the MRIP CH: SRHS discard ratio method to calculate headboat discards for 1981-2007 for SEDAR 74.

#### 4.5.5 SRHS Logbook Discards

The SRHS logbook form was modified in 2004 to include a category to collect self-reported discards for each reported trip. This category is described on the form as the number of fish by species released alive and number released dead. Port agents instructed each captain on criteria for determining the condition of discarded fish. A fish is considered “released alive” if it is able to swim away on its own. If the fish floats off or is obviously dead or unable to swim, it is considered “released dead”. As of Jan 1, 2013 the SRHS began collecting logbook data electronically. Changes to the trip report were also made at this time, one of which removed the condition category for discards (i.e., released alive vs. released dead). The form now collects only the total number of fish released, regardless of condition.

**Task 8:** Determine proxy for estimated headboat discards from 1981-2007 for the West Region and 1986 - 2007 for the Central and East Region. The ratio of the mean ratio of SRHS discard: landings (2008-2019) to the mean ratio of MRFSS CH discard: landings (2008-2019) was applied to the yearly MRIP charter boat discard: landings ratio (1986-2007, 1981-2007 in TX) in order to estimate the yearly SRHS discard: landings ratio (1986-2007, 1981-2007 in TX). This ratio was then applied to the SRHS landings (1986-2007, 1981-2007 in TX) in order to estimate headboat discards (1986-2007, 1981-2007 in TX).

The SEDAR 74 Recreational Working Group recommended using the MRIP CH: SRHS discard ratio proxy method 1981-2007 described above and the SRHS estimated discards 2008-2019.

The MRIP CH: SRHS discard ratio proxy method is the current SEDAR Best Practice method, and allows for changes in management and year class effects to be incorporated into the assessment (SEDAR-PW-07). Final estimated discards (1981-2019) are presented in Table 4.12.10 along with the proxy discard estimates. Uncertainty in SRHS discards for 2008-2019 use the same method described for the landings. Prior to 2008, MRIP CH CVs are used as a proxy for SRHS headboat CVs.

#### 4.5.6 Total Recreational Discards

Combined discard estimates (MRIP, SRHS, TPWD, and LA Creel) are shown in Tables 4.12.11-4.12.13, Figure 4.13.5, and mapped in Figure 4.13.6.

## 4.6 BIOLOGICAL SAMPLING

### 4.6.1 Landed Fish

#### 4.6.1.1 MRIP Biological Sampling

The MRIP angler intercept survey includes the collection of fish lengths from the harvested catch (landed, whole condition). Up to 15 of each landed species per angler interviewed are measured to the nearest mm along a centerline (defined as tip of snout to center of tail along a straight line, not curved over body). In those fish with a forked tail, this measure would typically be referred to as a fork length. In those fish that do not have a forked tail, it would typically be referred to as a total length, with the exception of some fish that have a single, or few, caudal fin rays that extend further. Weights are typically collected for the same fish measured, although weights are preferred when time is constrained. Ageing structures and other biological samples are not collected during MRIP assignments because of concerns over the introduction of bias to survey data collection. Discarded fish size is not collected by MRIP for any fishing mode.

Summaries of fish size for MRIP-sampled Red Snapper in the Gulf of Mexico by state (1981-2019) are provided in Table 4.12.14 (pounds whole weight) and Table 7 of SEDAR 74-DW-01 (millimeters fork length). Comparable summaries of fish size by mode are provided in Table 10 of SEDAR 74-DW-01 (pounds whole weight) and Table 9 of SEDAR 74-DW-01 (millimeters fork length). These summaries include the number of measured Red Snapper, number of angler trips from which Red Snapper were measured, and the minimum, average, and maximum size of all measured Red Snapper.

#### 4.6.1.2 LA Creel Biological Sampling

Size, weight, and age composition of recreationally landed Red Snapper have been collected from the LDWF Biological Sampling Program starting in 2014. During open Red Snapper season, size measurement targets are 30 fish sampled per area per mode (charter and private) per



week. Size measurements are maximum total lengths. Weight measurements are collected as time permits. Otolith sampling targets are obtained from the federal GulfFIN grants. Summaries of fish size, in millimeters total length and pounds whole weight, for LDWF-sampled Red Snapper in the Gulf of Mexico by mode (2014-2019) are provided in Tables 14 and 15, respectively of SEDAR 74-DW-01. These summaries include the number of Red Snapper sampled, number of angler trips from which Red Snapper were sampled, and the minimum, average, and maximum size of all sampled Red Snapper.

#### *4.6.1.3 TPWD Biological Sampling*

Length composition of the catch of Texas sport-boat anglers has been sampled by the TPWD since the high-use season of 1983 (mid-May). Total length is measured by compressing the caudal fin lobes dorsoventrally to obtain the maximum possible total length. Weights of sampled fish are not recorded, but lengths can be converted to weights using length-weight equations (SEDAR 70-WP-03).

Summaries of fish size, in millimeters total length, for TPWD-sampled Red Snapper in the Gulf of Mexico by mode (1983-2019) are provided in Table 13 of SEDAR 74-DW-01. These summaries include the number of measured Red Snapper, number of angler trips from which Red Snapper were measured, and the minimum, average, and maximum size of all measured Red Snapper.

#### *4.6.1.4 SRHS Biological Sampling*

Lengths were collected by headboat dockside samplers beginning in 1972. From 1972 to 1975, only North Carolina and South Carolina were sampled whereas Georgia and northeast Florida sampling began in 1976. The SRHS conducted dockside sampling throughout the southeast portion of the US (from the NC-VA border to the Florida Keys) beginning in 1978. SRHS dockside sampling has been conducted in all Gulf States since 1986, except for Mississippi where sampling started in 2010. Weights are typically collected for the same fish measured during dockside sampling. Biological samples (scales, otoliths, spines, stomachs, and gonads) are also collected routinely and processed for aging, diet studies, and maturity studies.

Summaries of fish size, in kilograms whole weight, for SRHS-sampled Red Snapper in the Gulf of Mexico (1986-2019) are provided in Table 4.12.15. These summaries include the annual number of measured Red Snapper, the number of trips from which Red Snapper were measured, and the minimum, average, and maximum size of Red Snapper measured by SRHS dockside samplers.

#### *4.6.1.5 MDMR Biological Sampling*

The Mississippi Department of Marine Resources (MDMR) conducts numerous fishery dependent surveys that gather length and age data from both the commercial and recreational fleet. Biosampling, funded through GSMFC, is the project that collects Red Snapper commercial lengths and ages from brick and mortar federal dealers in coastal Mississippi. MRIP and Tails N' Scales (TNS) have dockside surveys with a PPS-based design where lengths and ages are collected from the recreational fleet. Since 2016, MDMR has expanded its efforts to collect biological data on the Red Snapper recreational fishery through the TNS program. All age data is entered through the GulfFIN Oracle database for both recreationally and commercially sampled Red Snapper.

#### *4.6.1.6 AMRD Biological Sampling*

The Alabama Marine Resources Division (AMRD) of the Alabama Department of Conservation and Natural Resources (ADCNR) collects biological data from commercial and recreational fisheries through a variety of projects. The data used in SEDAR 74 analyses was derived from state-federal cooperative projects such as the Gulf States Marine Fisheries Commission's Biological Sampling activity (as part of GulfFin) and MRIP (APAIS) for the recreational sector and NOAA Fisheries' TIP for the commercial sector. The recreational sector includes private and for-hire (federal and state) anglers. Fish length (fork length) was collected in each project and individual fish weights were collected as part of the GulfFin Biological Sampling and MRIP. The APAIS uses a probability-based sampling methodology while the Biological Sampling and TIP activities use opportunistic sampling. The Biological Sampling program also collects otoliths which were used in the ageing section. The data programs representing Alabama length and age data are described in more detail in SEDAR 74-DW-15.

#### *4.6.1.7 FWRI Biological Sampling*

The Fishery Dependent Monitoring subsection (FDM) of the Florida Fish and Wildlife Conservation Commission's Fish and Wildlife Research Institute (FWRI) monitors recreational fishing in marine environments along the Florida coast in association with several fishery-dependent research and monitoring projects. FDM administers the Marine Recreational Information Program (MRIP) for the recreational sector. Additionally, FDM conducts several unique surveys of recreational anglers that allow for the collection of supplemental biological data. The state surveys that provide information from harvested fish include: the At-Sea Observer sampling of for-hire vessels (headboat and charter boat; 2005-present, sampling stoppages described in SEDAR 74-DW-18), the State Reef Fish Survey of offshore private recreational fishers (2015-present), and supplemental biological sampling of recreational anglers (shore and private boat mode) via opportunistic biological sampling (2000-2018) and a formalized biological sampling survey based on a randomized draw (2018-present, the State Representative Biological Survey). Each fishery-dependent research or monitoring project that contributed to the age and length data provided to the Life History Group is described in SEDAR

74-DW-07, including a description of the ageing protocols used by the Fish and Wildlife Research Institute (FWRI) Age and Growth Lab.

Age data are summarized for a total of 61,211 individuals. The majority of age samples were obtained from surveys of the recreational sector, including 3,338 samples from private recreational boat trips, 23,453 from charter trips, and 6,622 from headboats. In addition, 296 aged fish were from an unknown source (primarily fishing tournaments; Table 1 - SEDAR 74-DW-07). Over 95% of fish aged from the private boat fishery were collected between 2009 and 2019 with total otolith collections being above 100 per year every year since 2014 (Tables 2 & 3 - SEDAR 74-DW-07). Over 58% of otoliths collected from charter vessels were collected from before 2009 with fish collected in NWFL representing the bulk of collections each year (Table 2 & 3 - SEDAR 74-DW-07). Headboat samples were heavily concentrated in the later period as well, with large collections in 2014 and 2015 in NWFL (Table 2 & 3 - SEDAR 74-DW-07).

#### *4.6.1.8 Nominal Length Frequency Distributions of Landings*

Length data from the recreational fisheries of the Gulf of Mexico are collected by federal and state agencies including TPWD, LDWF, MDMR, AMRD, and FWRI. Sources utilized include data collected in each state (described above) and warehoused by Gulf States Marine Fisheries Commission (GSMFC) in the GulfFIN database (2001-2019), MRIP (1981-2019), and SRHS (1986-2019). Sample sizes were more limited prior to 2007, particularly in the Eastern Gulf as defined in the Stock ID Workshop due to low Red Snapper abundance in this region. Any existing total length measurements without an associated fork length measurement were converted using the morphometric equation derived by the Life History Working Group for the Gulf of Mexico stock at the SEDAR 74 Data Workshop.

**Task 9a:** Nominal length frequencies were generated for recreational data by mode and stock ID region. Length compositions within regions defined in the Stock ID Workshop were investigated using the finest spatial scale allowed by SRHS survey domains for headboat mode (Figure 4.13.7) and by MRIP survey domains for charter boat mode (Figure 4.13.8). Private mode samples did not support viewing the data at this resolution. These figures indicate approximately similar length compositions within stock ID regions allowing for spatial aggregation of samples into nominal length compositions (e.g. not requiring a weighting procedure). Length compositions by recreational fishing mode (CB, HB, PR) were shown by stock ID region in time blocks (Figure 4.13.9) alongside associated sample sizes (Table 4.13.16) to compare length composition by mode and provide context for reliability based on data availability. This figure also shows potential stock recovery through time as the length compositions were the largest in recent years for all modes and stocks. These length frequency distributions indicate that headboat and charter boat modes are sufficiently dissimilar to model separately in this assessment, as was done in SEDAR 51.

Data were sufficient to provide nominal length compositions for all fleets except in the Eastern Stock, where temporal aggregations were recommended for all modes to meet minimum sample size thresholds, as was approved at panel (Table 4.12.17). Sampling prior to 2007 was sparse, but increases in recent years have allowed for the estimation of annual compositions since 2018. Sample sizes between 2008 and 2017 have allowed for temporal aggregations of two to three years.

#### 4.6.1.9 Aging Data

Age samples are collected as part of the SRHS sampling protocol. Age samples collected from the private/rental boat, charter boat, and shore modes come from a number of sources including state fishery-dependent sampling programs (described above) and special projects. The number of Red Snapper aged from the recreational fishery by year and stock is summarized in Table 4.12.18. The number of trips these ages were collected from are summarized in Table 4.12.19. Nominal age frequencies were generated for recreational data by mode and stock ID region (SEDAR74-DW-15). The final recreational age composition inputs will be determined in the assessment phase.

### 4.6.2 Discarded Fish

#### 4.6.2.1 Headboat At-Sea Observer Survey Biological Sampling

At-sea sampling of headboat (2005 to present) and charterboat (2009 to present) discards were initiated as part of the improved for-hire surveys to characterize the size distribution of live discarded fish. Headboat observer data was collected in both Florida and Alabama from 2005 to 2007 but continued in Florida after 2009 to the present. A summary of the live discard length data from Florida and Alabama from 2005-2007 was provided to analysts and described in SEDAR 74-DW-18. Data collections in Florida are conducted year-round. During the data workshop discussions, additional data from at-sea observer sampling conducted in Mississippi from 2016-2020 and Alabama from 2017-2019 were identified. In both states, new initiatives have allowed for the collection of additional discard length data from both the headboat (MS=470) and charter (MS=554, AL=293) fleets. Data collection in Mississippi and Alabama only occurs during the open Red Snapper season. Summary statistics for data collected in each state is represented in Table 4.12.20.

#### 4.6.2.2 Weighted and Nominal Length Frequency Distributions of Discards

##### **Task 9b:**

##### *Eastern stock ID region*

Length measurements from 4,642 fish were used to generate headboat and charterboat discard length frequency distributions from the eastern stock ID region.

- Headboat lengths in this stock ID region (n=3,258) are available from 2005 to 2019 and are summarized in Table 4.12.20. The procedure for weighting headboat data to account for uneven sampling of different trip durations in each Florida region was discussed. This is particularly necessary to address oversampling of multi-day trips in Florida, in comparison to the proportion of multi-day trips reported by the headboat fleet (SEDAR 74-DW-18). Annual headboat discard length compositions are presented in the right panel (SWFL) of Figure 1 of SEDAR 74-DW-18 in blue. These discard length compositions were reviewed and recommended by the Recreational Working Group.
- Charterboat lengths in this stock ID region (n=1,384) are available from 2005 to 2020 and are summarized in Table 4.12.20. Charter discard length frequency data has not been weighted in past SEDAR assessments, with only nominal discard length compositions generated. Annual charterboat discard length compositions are presented in the right panel (SWFL) of Figure 2 of SEDAR 74-DW-18 in blue. These discard length compositions were reviewed and recommended by the Recreational Working Group.

#### *Central stock ID region*

Length measurements from 26,568 fish were used to generate headboat and charterboat discard length frequency distributions from the central stock ID region. The introduction of data from Mississippi and Alabama during this assessment led to additional data investigations to determine how to incorporate the Mississippi and Alabama data with northwest Florida data to provide a more complete representation of discard length data in the central stock assessment region.

- Headboat lengths in this stock ID region (n=17,223) are available from 2005 to 2020 in Florida, 2005 to 2007 in Alabama, and 2016 to 2020 in Mississippi (Table 4.12.20). NWFL data is weighted by trip type as described in SEDAR 74-DW-18 to correct for sampling of different trip lengths. Similar information to weight lengths in Alabama and Mississippi was not available. Nominal headboat compositions from Alabama were compared to both weighted and unweighted NWFL length compositions (Figure 4.13.10) and found to overlap closely for the 2005-2007 time period when data were collected in both states, regardless of weighting. Nominal headboat compositions from Mississippi were also compared to both weighted and unweighted NWFL length compositions (Figure 4.13.11) and found to have similar central tendencies for the 2016-2020 time period when data were collected in both states, regardless of weighting. NWFL does show some additional discarding of legal sized fish as compared to Alabama and Mississippi, whose data is only collected during the open season. Florida data is collected year round, and many discards are observed in the closed season, in addition to the open

season. Based on these findings the Recreational Working Group considered three options for the headboat discard length compositions in the central stock ID region:

- Option 1 – Use only the FL length data and AL 2005-2007 headboat data, weighted to correct for trip type
  - Pro: consistent with how data has been treated in the past assessments
  - Con: excludes the new data available from Mississippi
- Option 2 – Use unweighted Alabama and Mississippi data combined with weighted Florida data.
  - Pro: uses all available data from the central stock ID region to inform discard length distributions
  - Con: does not weight distributions between states to account for differences in the magnitude of discards
- Option 3 – Determine a way to weight the state discard data between states, to appropriately account for the magnitude of discard contributions for each state
  - Pro: uses all the new data
  - Con: requires the analysts to develop a method for weighting the data between states to account for the magnitude of the contribution for each state.

The Recreational Working Group recommended option 2 of combining the unweighted Alabama and Mississippi data with the weighted NWFL data to create the headboat discard length composition for the central stock assessment region (Figure 4.13.12) in order to use all available data to from the central stock ID region to characterize its discard length distributions. Option 3 was put forward as a research recommendation in section 4.10.2.

- Charterboat lengths in this stock ID region (n=9,345) are available from 2009 to 2020 in Florida, 2017 to 2019 in Alabama, and 2016 to 2020 in Mississippi (Table 4.12.20). Charter discard length frequency data has not been weighted in past SEDAR assessments, with only nominal discard length compositions generated. Annual charterboat compositions from Alabama, Mississippi, and NWFL were compared for the 2017-2019 time period when data were collected in all three states (Figure 4.13.13). Charterboat data show a similar trend to headboat data, where generally the central tendencies of the length frequencies overlap, but Florida data shows a broader range of lengths associated with discarded Red Snapper. The Recreational Working Group recommended combining all Mississippi, Alabama, and NWFL data to create the charterboat discard length composition for the central stock assessment region (Figure 4.13.14).

#### *Western stock ID region*

There are no discard length information available from the Western region.

## 4.7 RECREATIONAL EFFORT

### 4.7.1 MRIP Effort

MRIP effort estimates are produced via the Fishing Effort Survey (FES) for private/rental boats and shore mode and the For-Hire Survey (FHS) for charter boat mode. MRIP effort is calculated in units of angler trips, which represents a single day of fishing in the specified mode that does not exceed 24 hours and is provided by year and state in Table 17 of SEDAR 74-DW-01. This table includes MRIP effort estimates for West Florida, Alabama, and Mississippi for all years and Louisiana from 1981 to 2013.

### 4.7.2 LA Creel Effort

LA Creel effort estimates (in angler trips) are provided for Louisiana for years 2014-2019 in Table 17 of SEDAR 74-DW-01 for all modes combined. LA Creel effort estimates are provided by mode in Table 4.12.21, where private effort estimates are calibrated to MRIP-FES units.

### 4.7.3 TPWD Effort

Texas effort estimates (in angler trips) from TPWD are provided in Table 17 of SEDAR 74-DW-01 for years 1983-2019 for all modes combined. TPWD effort estimates are provided by mode in Table 4.12.21, where private effort estimates are calibrated to MRIP-FES units.

### 4.7.4 SRHS Effort

Effort data from the SRHS is provided as the number of anglers on a given trip, which is standardized to “angler days” based on the length of the trip (e.g., 40 anglers on a half-day trip would yield  $40 * 0.5 = 20$  angler days). Angler days are summed by month for individual vessels. Each month, port agents check the logbook trip reports for accuracy and completeness. Although reporting via the logbooks is mandatory, compliance is not 100% and is variable by location. To account for non-reporting, a correction factor is developed based on sampler observations, angler numbers from office books, and any available information. This information is used to provide estimates of total catch by month and area, along with estimates of effort.

SRHS effort estimates (in angler days) are provided in Table 4.12.22. Estimated headboat angler days have remained relatively stable in the Gulf of Mexico in recent years. The most obvious factor which impacted the headboat fishery in both the Atlantic and Gulf of Mexico was the effect of COVID in 2020. Reports from industry staff, captains/owners, and port agents indicated health concerns and restrictions most affected the number of trips and number of passengers reducing overall fishing effort.

In order to summarize recreational fishing effort across the Gulf of Mexico, SRHS effort estimates are also provided in units of angler trips to match that provided by the MRIP, TPWD, and LA Creel surveys. Monthly estimates of angler trips are calculated as the product of the

reported number of anglers and ratios for the estimated number of total trips to the reported number of total trips (SEDAR 28-DW-12).

#### 4.7.5 Total Recreational Fishing Effort

Combined effort estimates in angler trips (MRIP, SRHS, TPWD, and LA Creel) are shown by year, mode, and stock ID in Table 4.12.23, Figure 4.13.15, and mapped in Figure 4.13.16. These effort estimates depict all recreational fishing activity in the Gulf of Mexico and are not specific to Red Snapper.

## 4.8 COMMENTS ON ADEQUACY OF DATA FOR ASSESSMENT ANALYSES

**Task 10:** Regarding the adequacy of the available recreational data for assessment analyses, the Recreational Working Group discussed the following:

- Calibrations to MRIP-FES units for TPWD (1981-2019) and LA Creel (2014-2019) were presented and recommended for use during the Data Workshop. Several research recommendations (#1-3) are critical to address prior to the Operational Assessment for Red Snapper to further refine these landings estimates. Landings, as adjusted, appear to be adequate for the time period covered (1955-2019).
- Since there are no discard estimates from Texas, a proxy discard rate from Louisiana was used to fill in this data gap. Similarly, headboat mode discards prior to 2008 used a proxy discard rate from the charter mode. Discards are self-reported from all data sources. Discards, as adjusted, appear to be adequate for the time period covered (1981-2019).
- Size data appear to adequately represent the landed catch for all modes.
- Discard size data from the headboat and charterboat fleets appear to be (1) regulatory discards and/or (2) adequate for describing the size composition of discarded Red Snapper.

## 4.9 Itemized List of Tasks for Completion following Workshop

- The following tasks were completed by the Recreational Working Group during one internal working group webinar (May 31st) and two post workshop webinars with the full panel (May 23rd and July 5th):
  - SRHS uncertainty
  - Historical landings
  - Discard length comps
 The methods for these analyses are fully described in this report.
- Weighted length and age compositions will be completed for the Assessment Workshop and described in that report.

## 4.10 RESEARCH RECOMMENDATIONS



#### 4.10.1 Evaluation and Progress of Research Recommendations from Previous Assessments

Research recommendations from SEDAR 31 in 2013 were evaluated and progress on each item is outlined below:

1. Evaluate the technique used to apply sample weights to landings. Investigate the SEFSC method by analyzing the order of variables in the hierarchy and the minimum number of fish used. Furthermore, evaluate alternative methods, including a meta-analysis of the existing information from different sources, areas, states, surveys, etc. that could be performed.

##### ***Evaluation of Progress***

- Clarity has been requested regarding the first line of this research recommendation. The sample weights here are referring to the weight of the fish sampled in APAIS and how those are used to calculate average weights for landings estimates in pounds whole weight. They do not refer to survey design sample weights used by MRIP to estimate catch.
  - The minimum number of fish used was evaluated in 2019 and an adjusted minimum sample size of 15 fish per strata was recommended and has been used since (SEDAR 67-WP-06).
  - Additional size information from LA BIO has been incorporated into the SEFSC weight estimation method since 2021.
2. Develop methods to identify angler preference and targeted effort. Require a reef fish stamp for anglers targeting reef fish, pelagic stamp for migratory species, and deep-water complex stamp for deep-water species. The program would be similar to the federal duck stamp required of hunters and could help managers identify what anglers were fishing for.

##### ***Evaluation of Progress***

- Florida requires private boat anglers to possess a State Reef Fish designation to legally possess a suite of reef fishes, including Red Snapper. This serves as a directory that is used to directly survey participants and estimate reef fish effort in Florida.
3. Continue and expand fishery-dependent at-sea observer surveys to collect discard information. This would help to validate self-reported headboat discard rates.

##### ***Evaluation of Progress***

- Additional at-sea sampling programs for for-hire vessels have begun in Mississippi and Alabama and are described above in 4.6.2.1.
  - The State of Florida dedicated recurring funds starting in 2020 to support this work long-term and provide stability. Data are available upon request for NOAA Fisheries to validate headboat discard rates.
4. Track Texas commercial and recreational discards.

##### ***Evaluation of Progress***

- No progress noted

5. Estimate variances associated with the headboat program.

***Evaluation of Progress***

- Method developed in SEDAR 68 Research Track assessment for Scamp and described in SEDAR 68-DW-31.
- Alternative method described above in section 4.3.4 and recommended for use in SEDAR 74.

6. Evaluate existing and new methods to estimate historical landings. Hind-casting of Red Snapper landings is complicated by a lack of reliable historical effort data. To get at estimating historical effort, analysts could track consumables (gas, ice, bait) to develop price indices.

***Evaluation of Progress***

- No progress noted

7. Investigate how CPUE changes over time due to technological advances and changes in fishing practices.

***Evaluation of Progress***

- Adjusted ratios to account for technological advances from 1955 to 1980. These are described above in 4.4.5.
- Expanded years used in CPUE calculation to include 1981 to 1989, a period of time when the Red Snapper fishery was generally unregulated.

#### *4.10.2 Research Recommendations for SEDAR 74*

***Task 11:***

1. SSC to add TOR to operational assessment to include topical working group to review and evaluate the results of the Gulf of Mexico transition plan to optimize the use of state and federal data.
2. Integrate TPWD into the Gulf Transition Team in order to further evaluate the proposed calibration between TPWD and MRIP units and identify alternative methods that may be implemented, including increased benchmarking (e.g. 3-year benchmark period).
3. Gulf Transition Team should investigate the drivers of high MRIP wave specific effort estimates for recreational modes during traditionally low effort waves (e.g. winter waves, particularly in MS).
4. Develop and implement methods in the western Gulf region to collect vital statistics on the size distribution of recreational discards and directly estimate the magnitude of recreational discards in Texas.
5. Investigate the need for weighting headboat discard length composition data from new data streams. Determine if data need to be weighted due to over or under sampling of any

particular trip types. If so, provide total number of trips sampled by state (or headboat region) and year, dock to dock hours for each trip, fleet (charter vs headboat), and catch type (harvest vs discard).

6. Investigate methods for weighting charter discard length composition data (to account for uneven sampling of trip types), or determine if weighting by trip type is necessary for that fleet.
7. Develop methods to properly weight discard length composition data from different states relative to the proportional magnitude of discards.
8. Develop statistically valid methods to identify outlier estimates (e.g. extremely high catches) and adjust sample weights for records that have a disproportionately high influence on total catch estimates, and establish new SEDAR best practice methods.
9. Provide working paper or presentations during the data workshop group meeting documenting collection methods and caveats for new data streams being evaluated / used.
10. Develop a list of qualitative information about the snapper-grouper fishery from stakeholders and methods to evaluate validity.
11. Research of additional reference points for historical landings.
12. Estimate and publish historical landings for major species (or species groups) in a single initiative to ensure a consistent methodology.
13. General evaluation of start year of existing models and value of historical data.
14. Evaluate how changes in fishing outcomes (fish for freezer vs. offshore experience with a few filets for dinner) have impacted fishing behavior over time. Important for determining validity of some historical landings assumptions.

#### 4.11 LITERATURE CITED

- Brennan, K. 2020. SEDAR 68-DW-11. Estimates of Historic Recreational Landings of Scamp and Yellowmouth Grouper in the Gulf of Mexico Using the FHWAR Census Method. National Marine Fisheries Service (NMFS) Southeast Fisheries Science Center (SEFSC) Fisheries Statistics Division. Miami, FL.
- Cross, R. 2022. Florida State Reef Fish Survey Metadata. SEDAR 74-DW-05. Florida Fish and Wildlife Conservation Commission, St. Petersburg, FL. 2 pp.
- Dettloff, K and V Matter. 2019. SEDAR 64-RD-12. Model-estimated conversion factors for calibrating Coastal Household Telephone Survey (CHTS) charterboat catch and effort estimates with For Hire Survey (FHS) estimates in the Atlantic and Gulf of Mexico with application to red grouper and greater amberjack. National Marine Fisheries Service (NMFS) Southeast Fisheries Science Center (SEFSC) Fisheries Statistics Division. Miami, FL.

- Dettloff, K and V Matter. 2019. SEDAR 67-WP-06. Sample Size Sensitivity Analysis for calculating MRIP Weight Estimates. National Marine Fisheries Service (NMFS) Southeast Fisheries Science Center (SEFSC) Fisheries Statistics Division. Miami, FL.
- Dettloff, K, V Matter, and M Nuttall. 2020. SEDAR 68-DW-10. SEFSC Computation of Variance Estimates for Custom Data Aggregations from the Marine Recreational Information Program. National Marine Fisheries Service (NMFS) Southeast Fisheries Science Center (SEFSC) Fisheries Statistics Division. Miami, FL.
- Lazarre, D. 2022. SEDAR 74-DW-18. A Summary of Observer Data from the Size Distribution of Red Snapper Discards from Recreational Fishery Surveys in the Eastern Gulf of Mexico. Florida Fish and Wildlife Conservation Commission, St. Petersburg, FL.
- Matter, VM and A Rios. 2013. SEDAR 32-DW-02. MRFSS to MRIP Adjustment Ratios and Weight Estimation Procedures for South Atlantic and Gulf of Mexico Managed Species. National Marine Fisheries Service (NMFS) Southeast Fisheries Science Center (SEFSC) Fisheries Statistics Division. Miami, FL.
- Matter, V, N Cummings, J Isely, K Brennan, and K Fitzpatrick. 2012. SEDAR 28-DW-12. Estimated conversion factors for calibrating MRFSS charterboat landings and effort estimates for the South Atlantic and Gulf of Mexico in 1981-1985 with For Hire Survey estimates with application to Spanish mackerel and cobia landings. National Marine Fisheries Service (NMFS) Southeast Fisheries Science Center (SEFSC) Fisheries Statistics Division. Miami, FL.
- Matter, V and M Nuttall. 2020. SEDAR 68-DW-13. Marine Recreational Information Program: Metadata for the Atlantic, Gulf of Mexico, and Caribbean Regions. National Marine Fisheries Service (NMFS) Southeast Fisheries Science Center (SEFSC) Fisheries Statistics Division. Miami, FL.
- NMFS Office of Science and Technology. 2019. SEDAR 74-RD-110. Texas Fishing Effort Survey – Final Project Report. National Marine Fisheries Service (NMFS) Office of Science and Technology (OST) Fisheries Statistics Division. Silver Spring, MD.
- NMFS Office of Science and Technology. 2022. SEDAR 74-DW-10. Methodology Description for a Calibration of Texas Private Boat Red Snapper Annual Landings Estimates. National Marine Fisheries Service (NMFS) Office of Science and Technology (OST) Fisheries Statistics Division. Silver Spring, MD.
- NMFS Office of Science and Technology. 2022. SEDAR 74-DW-11. Evaluating Uncertainty in Gulf Red Snapper Estimates: A Preliminary Sensitivity Analysis of Non-Sampling Errors in the Region's Recreational Fishing Surveys. National Marine Fisheries Service (NMFS)

Office of Science and Technology (OST) Fisheries Statistics Division. Silver Spring, MD.

Nuttall, M and V Matter. 2020. SEDAR 70-WP-03. Texas Parks and Wildlife Department's Marine Sport-Harvest Monitoring Program Metadata. National Marine Fisheries Service (NMFS) Southeast Fisheries Science Center (SEFSC) Fisheries Statistics Division. Miami, FL.

Nuttall, M. 2022. SEDAR 74-DW-01. General Recreational Survey Data for Red Snapper in the Gulf of Mexico. National Marine Fisheries Service (NMFS) Southeast Fisheries Science Center (SEFSC) Sustainable Fisheries Division. Miami, FL.

Nuttall, M and K Dettloff. 2022. SEDAR 74-DW-12. SEFSC Computation of Uncertainty for General Recreational Landings-in-Weight Estimates, with Application to SEDAR 74 Gulf of Mexico Red Snapper. National Marine Fisheries Service (NMFS) Southeast Fisheries Science Center (SEFSC) Sustainable Fisheries Division. Miami, FL.

Rago, P. 2022. SEDAR 74-DW-29. Draft of the Summary Report from the Gulf State Recreational Catch and Effort Surveys Transition Feb 2022 Workshop. Gulf MRIP Transition Team.

SEDAR Procedural Workshop 7. 2015. SEDAR-PW-07. Data Best Practices. SEDAR, North Charleston, SC. 151 pp.

SEDAR. 2021. SEDAR 74 Gulf of Mexico Red Snapper Stock ID Process: Final Report. SEDAR, North Charleston, SC. 87 pp.

Stevens, M. 2022. SEDAR 74-DW-15. Gulf of Mexico Red Snapper (*Lutjanus campechanus*) Commercial and Recreational Landings Length and Age Compositions. National Marine Fisheries Service (NMFS) Southeast Fisheries Science Center (SEFSC) Sustainable Fisheries Division. Miami, FL. 21 pp.

Vecchio, J, D Lazzarre, B Sauls, M Head, and T Moncrief. 2022. SEDAR 74-DW-06. A description of Florida's Gulf Coast recreational fishery and release mortality estimates for the central and eastern sub-regions (Mississippi, Alabama, and Florida) with varying levels of descender use. SEDAR, North Charleston, SC. 27 pp.

Vecchio, J, J Carroll, D Lazzarre, and B Sauls. 2022. SEDAR 74-DW-07. Size and Age Information for Red Snapper, *Lutjanus campechanus*, collected in association with fishery-dependent projects along Florida's Gulf of Mexico coast. Florida Fish and Wildlife Conservation Commission, St. Petersburg, FL. 24 pp.

Zhang, X, J West, and J Adriance. 2022. SEDAR 74-DW-04. LA Creel/MRIP Red Snapper Private Mode Landings and Discards Calibration Procedure. Louisiana Department of Wildlife and Fisheries (LDWF) Office of Fisheries. Baton Rouge, LA.

## 4.12 TABLES

**Table 4.12.1.** Annual landings estimates of Texas Red Snapper from the TPWD survey. Landings are provided in number of fish and pounds whole weight. Estimates for the private mode are calibrated into MRIP-FES units (SEDAR 74-DW-10).

Year	AB1				LBS			
	Priv	CV	Cbt	CV	Priv	CV	Cbt	CV
1981	691,216	0.536	6,107	0.317	964,882	0.560	8,584	0.453
1982	691,216	0.536	6,107	0.317	964,882	0.685	8,584	0.348
1983	665,988	0.241	10,663	0.424	860,015	0.620	12,377	0.489
1984	386,998	0.292	617	1.000	793,485	0.652	1,081	1.000
1985	1,020,660	1.051	7,042	0.509	1,241,145	1.047	12,294	0.642
1986	1,391,561	0.892	5,131	1.000	1,941,752	0.907	7,441	1.000
1987	409,581	0.381	9,858	0.688	671,000	0.436	25,172	0.702
1988	575,887	0.414	737	0.575	907,992	0.537	2,610	0.575
1989	252,179	0.292	1,108	0.786	388,568	0.404	1,609	0.786
1990	271,611	0.310	11	1.000	445,023	0.443	18	1.000
1991	440,828	0.287	674	0.700	853,469	0.406	1,300	0.722
1992	373,451	0.206	369	1.001	878,931	0.329	923	1.001
1993	429,438	0.215	6,974	1.000	1,156,866	0.270	35,762	1.000
1994	836,610	0.215	10,427	0.482	2,283,231	0.293	40,960	0.551
1995	978,013	0.184	7,637	0.625	3,162,183	0.241	28,800	0.662
1996	858,354	0.206	6,983	0.542	3,126,608	0.248	28,067	0.571
1997	800,066	0.195	6,774	0.436	2,861,526	0.234	25,209	0.469
1998	595,592	0.220	11,464	0.490	2,449,531	0.254	43,807	0.506
1999	489,698	0.221	9,110	0.376	1,698,134	0.296	43,799	0.473
2000	484,304	0.226	8,278	0.396	1,595,688	0.290	28,127	0.476
2001	386,115	0.208	13,179	0.391	1,244,578	0.247	38,387	0.431
2002	401,941	0.189	16,018	0.382	1,491,961	0.240	53,611	0.398
2003	351,838	0.195	6,068	0.308	1,185,037	0.225	20,752	0.325
2004	342,040	0.199	9,387	0.322	1,059,382	0.236	31,821	0.376
2005	503,911	0.193	9,860	0.571	1,815,866	0.253	37,353	0.586
2006	572,127	0.198	10,222	0.266	1,967,777	0.225	26,527	0.299
2007	387,565	0.201	11,610	0.264	1,419,224	0.227	42,566	0.289
2008	336,689	0.251	6,428	0.506	1,598,673	0.275	32,046	0.522
2009	312,689	0.200	5,699	0.271	1,767,540	0.220	34,614	0.297
2010	244,081	0.227	7,674	0.423	1,411,158	0.245	51,635	0.501
2011	321,245	0.219	6,113	0.538	1,693,875	0.240	40,816	0.572
2012	318,444	0.198	4,975	0.244	1,540,916	0.233	39,449	0.263
2013	480,031	0.210	5,105	0.372	2,450,765	0.242	32,243	0.401
2014	364,045	0.236	6,570	0.312	1,890,259	0.275	35,449	0.344
2015	438,408	0.183	9,723	0.214	2,221,805	0.210	53,274	0.234
2016	243,263	0.213	6,849	0.242	1,341,975	0.246	39,842	0.263
2017	399,804	0.195	9,344	0.236	2,306,511	0.223	71,266	0.257
2018	479,475	0.186	10,429	0.317	2,891,976	0.211	77,151	0.325
2019	750,411	0.206	11,521	0.300	4,249,764	0.228	83,228	0.321

**Table 4.12.2.** Estimated SRHS headboat landings of Gulf of Mexico Red Snapper. Landings are provided in number of fish and pounds whole weight. CVs are provided for landings estimates in number of fish and can be used as a proxy for uncertainty of estimates in weight. CVs for headboat mode (1981-1985) do not include uncertainty around the estimated TX headboat landings and are calculated from MRIP LA data.

Year	Number						Pounds		
	West	CV	Central	CV	East	CV	West	Central	East
1981	335,366	0.570					416,169		
1982	335,366	0.970					416,169		
1983	335,366	0.300					416,169		
1984	335,366	0.430					416,169		
1985	335,366	0.610					416,169		
1986	316,090	0.399	14,903	0.888	1,461	0.594	372,643	34,204	3,644
1987	319,348	0.387	9,256	0.710	429	0.759	384,748	25,022	1,274
1988	423,024	0.344	12,881	0.218	951	0.668	581,361	30,605	2,195
1989	372,473	0.233	10,357	0.241	440	0.573	962,620	22,824	1,004
1990	187,006	0.300	15,393	0.191	146	0.215	342,555	35,331	429
1991	264,686	0.314	15,349	0.265	231	0.081	448,516	34,585	576
1992	413,056	0.209	33,832	0.190	41	0.115	872,859	77,060	152
1993	458,772	0.239	36,735	0.153	540	0.095	1,300,057	82,788	1,557
1994	497,738	0.215	28,771	0.192	227	0.241	1,441,644	83,204	615
1995	354,550	0.185	22,980	0.144	98	0.491	1,282,724	74,562	350
1996	349,266	0.320	28,314	0.086	74	0.428	1,324,394	84,173	225
1997	347,424	0.243	48,398	0.135	41	0.334	1,183,785	120,501	137
1998	244,738	0.138	76,455	0.140	304	0.586	940,659	183,412	685
1999	98,699	0.221	64,725	0.175	2,707	0.552	503,005	187,746	8,222
2000	111,410	0.193	56,399	0.108	1,241	0.608	585,453	173,964	3,877
2001	116,358	0.211	50,343	0.128	946	0.610	405,872	164,165	3,454
2002	138,475	0.088	74,945	0.156	176	0.482	607,223	217,093	493
2003	157,905	0.408	70,539	0.250	482	0.413	569,760	220,615	1,529
2004	110,329	0.119	62,020	0.246	1,462	0.327	503,163	185,771	4,348
2005	99,988	0.208	41,612	0.249	5,179	0.257	379,858	128,016	18,468
2006	121,177	0.206	46,744	0.385	1,138	0.264	450,708	122,689	2,845
2007	110,314	0.571	62,842	0.427	761	0.250	313,255	171,338	2,416
2008	57,569	0.244	60,630	0.087	1,356	0.066	222,711	180,280	4,965
2009	75,998	0.092	78,421	0.055	3,169	0.055	491,339	300,227	14,334
2010	51,514	0.055	33,932	0.063	2,011	0.098	284,081	136,540	8,909
2011	50,656	0.051	66,156	0.051	3,031	0.065	309,919	306,287	14,362
2012	54,283	0.092	51,710	0.081	2,468	0.054	440,874	265,255	17,955
2013	43,743	0.050	41,303	0.050	2,682	0.050	240,316	192,471	12,493
2014	35,511	0.050	40,547	0.050	2,210	0.050	195,438	176,566	10,289
2015	63,033	0.051	42,346	0.052	3,116	0.050	356,570	204,629	19,032
2016	61,137	0.052	35,553	0.051	2,896	0.050	352,210	162,091	12,278
2017	60,068	0.073	50,271	0.051	8,339	0.054	344,966	211,776	27,176
2018	62,595	0.052	56,764	0.051	8,690	0.052	371,114	244,814	36,716
2019	67,126	0.059	41,097	0.053	8,645	0.051	417,573	163,298	48,405



**Table 4.12.3.** Adjusted ratios used in FWHAR method for estimating historical Red Snapper recreational landings from 1955 to 1980 by stock ID region and mode.

1975-1980	West-Cbt	West-Priv	West-Hbt	West-Total	Central-Cbt	Central-Priv	Central-Hbt	Central - Total	East-Cbt	East-Priv	East-Hbt	East - Total
	0.07	0.44	0.10	0.61	0.10	0.17	0.06	0.33	0.01	0.06	0.00	0.065
1965-1974	West-Cbt	West-Priv	West-Hbt	West-Total	Central-Cbt	Central-Priv	Central-Hbt	Central - Total	East-Cbt	East-Priv	East-Hbt	East - Total
	0.17	0.27	0.17	0.61	0.13	0.12	0.08	0.33	0.03	0.04	0.00	0.065
1955-1964	West-Cbt	West-Priv	West-Hbt	West-Total	Central-Cbt	Central-Priv	Central-Hbt	Central - Total	East-Cbt	East-Priv	East-Hbt	East - Total
	0.28	0.10	0.23	0.61	0.16	0.08	0.09	0.33	0.05	0.02	0.00	0.065

**Table 4.12.4.** Estimated historical recreational landings in number of fish estimated for Red Snapper in the Gulf of Mexico 1955-1980. CV=1.0.

Year	West			Central			East			GOM
	Cbt	Hbt	Priv	Cbt	Hbt	Priv	Cbt	Hbt	Priv	Total
1955	386,180	317,219	137,921	220,674	124,129	110,337	62,065	2,936	24,826	1,386,287
1956	427,415	351,091	152,648	244,237	137,383	122,118	68,692	3,249	27,477	1,534,310
1957	468,650	384,962	167,375	267,800	150,637	133,900	75,319	3,563	30,127	1,682,332
1958	509,884	418,834	182,102	291,362	163,891	145,681	81,946	3,876	32,778	1,830,355
1959	551,119	452,705	196,828	314,925	177,145	157,463	88,573	4,190	35,429	1,978,377
1960	592,354	486,577	211,555	338,488	190,400	169,244	95,200	4,503	38,080	2,126,400
1961	612,128	502,819	218,617	349,787	196,755	174,894	98,378	4,653	39,351	2,197,383
1962	631,902	519,062	225,679	361,087	203,111	180,543	101,556	4,804	40,622	2,268,365
1963	651,675	535,305	232,741	372,386	209,467	186,193	104,734	4,954	41,893	2,339,348
1964	671,449	551,547	239,803	383,685	215,823	191,843	107,911	5,104	43,165	2,410,331
1965	427,552	409,552	666,533	321,070	185,240	304,961	62,785	5,255	92,037	2,474,983
1966	440,647	422,095	686,947	330,904	190,913	314,301	64,708	5,416	94,856	2,550,786
1967	453,741	434,639	707,361	340,738	196,586	323,641	66,631	5,576	97,674	2,626,589
1968	466,836	447,183	727,776	350,571	202,260	332,982	68,554	5,737	100,493	2,702,392
1969	479,931	459,726	748,190	360,405	207,933	342,322	70,477	5,898	103,312	2,778,195
1970	493,026	472,270	768,604	370,238	213,607	351,662	72,400	6,059	106,131	2,853,998
1971	538,766	516,084	839,910	404,587	233,424	384,287	79,116	6,621	115,977	3,118,772
1972	584,505	559,898	911,216	438,935	253,241	416,912	85,833	7,184	125,823	3,383,547
1973	630,245	603,712	982,522	473,283	273,058	449,537	92,550	7,746	135,669	3,648,321
1974	675,985	647,526	1,053,828	507,631	292,875	482,161	99,267	8,308	145,515	3,913,096
1975	276,637	424,227	1,833,549	417,209	250,337	696,198	24,444	8,870	235,714	4,167,184
1976	277,758	425,946	1,840,979	418,900	251,351	699,019	24,543	8,906	236,669	4,184,071
1977	278,879	427,665	1,848,409	420,591	252,366	701,840	24,642	8,942	237,624	4,200,958
1978	280,000	429,384	1,855,839	422,281	253,380	704,661	24,741	8,978	238,579	4,217,845
1979	281,121	431,104	1,863,270	423,972	254,395	707,482	24,840	9,014	239,535	4,234,731
1980	282,242	432,823	1,870,700	425,663	255,409	710,304	24,939	9,050	240,490	4,251,618

**Table 4.12.5.** Estimated historical recreational landings in **pounds whole weight** estimated for Red Snapper in the Gulf of Mexico 1955-1980. CV=1.0.

Year	West			Central			East			GOM
	Cbt	Hbt	Priv	Cbt	Hbt	Priv	Cbt	Hbt	Priv	Total
1955	1,462,722	454,965	252,651	541,436	244,822	239,518	188,210	8,195	55,735	3,448,254
1956	1,618,907	503,546	279,628	599,249	270,964	265,092	208,306	9,068	61,687	3,816,447
1957	1,775,092	552,124	306,606	657,063	297,105	290,668	228,402	9,945	67,636	4,184,640
1958	1,931,272	600,705	333,584	714,873	323,246	316,242	248,498	10,818	73,588	4,552,826
1959	2,087,457	649,284	360,560	772,686	349,387	341,818	268,594	11,695	79,539	4,921,020
1960	2,243,641	697,864	387,537	830,500	375,530	367,392	288,690	12,568	85,491	5,289,214
1961	2,318,539	721,159	400,474	858,222	388,064	379,657	298,328	12,987	88,344	5,465,774
1962	2,393,436	744,455	413,410	885,948	400,600	391,919	307,965	13,408	91,198	5,642,340
1963	2,468,330	767,751	426,347	913,670	413,137	404,184	317,602	13,827	94,051	5,818,899
1964	2,543,227	791,046	439,283	941,393	425,673	416,449	327,236	14,246	96,907	5,995,460
1965	1,619,426	587,392	1,220,989	787,764	365,353	662,004	190,393	14,667	206,627	5,654,615
1966	1,669,025	605,382	1,258,385	811,892	376,542	682,279	196,225	15,116	212,955	5,827,801
1967	1,718,621	623,373	1,295,780	836,020	387,731	702,554	202,056	15,563	219,282	6,000,980
1968	1,768,221	641,364	1,333,177	860,146	398,922	722,831	207,887	16,012	225,611	6,174,171
1969	1,817,820	659,353	1,370,573	884,274	410,111	743,106	213,719	16,462	231,939	6,347,358
1970	1,867,420	677,344	1,407,968	908,400	421,302	763,382	219,550	16,911	238,268	6,520,545
1971	2,040,668	740,184	1,538,590	992,677	460,388	834,203	239,916	18,480	260,373	7,125,478
1972	2,213,912	803,023	1,669,212	1,076,952	499,473	905,025	260,285	20,051	282,477	7,730,411
1973	2,387,160	865,862	1,799,834	1,161,227	538,559	975,847	280,654	21,620	304,582	8,335,345
1974	2,560,408	928,702	1,930,456	1,245,502	577,644	1,046,666	301,024	23,188	326,687	8,940,276
1975	1,047,810	608,440	3,358,789	1,023,646	493,745	1,511,294	74,126	24,757	529,187	8,671,793
1976	1,052,056	610,905	3,372,399	1,027,795	495,745	1,517,418	74,426	24,857	531,331	8,706,932
1977	1,056,302	613,370	3,386,010	1,031,944	497,747	1,523,542	74,726	24,958	533,475	8,742,073
1978	1,060,548	615,836	3,399,621	1,036,091	499,747	1,529,665	75,026	25,058	535,619	8,777,210
1979	1,064,794	618,303	3,413,233	1,040,239	501,749	1,535,789	75,326	25,159	537,765	8,812,357
1980	1,069,040	620,768	3,426,844	1,044,388	503,749	1,541,915	75,627	25,259	539,909	8,847,499

**Table 4.12.6.** Total recreational landings estimates (AB1) for Gulf of Mexico Red Snapper combined across all surveys (MRIP, TPWD, LA Creel, and SRHS) by year and mode for the **West region**. Estimates and their associated coefficients of variation (CV) are provided for recreational landings in numbers of fish (AB1) and in pounds whole weight (LBS). CVs for headboat mode (1981-1985) do not include uncertainty around the estimated TX headboat landings and are calculated from MRIP LA data. CVs are not available in weight units for headboat mode starting in 1986.

Year	Hbt_AB1	Hbt_CV	Cbt_AB1	Cbt_CV	Priv_AB1	Priv_CV	Hbt_LBS	Hbt_CV	Cbt_LBS	Cbt_CV	Priv_LBS	Priv_CV
1981	354,536	0.570	225,895	0.555	3,075,407	0.647	507,923	0.620	740,490	0.623	6,823,347	0.663
1982	358,850	0.970	274,792	0.948	1,863,327	0.388	439,374	0.970	449,503	0.950	3,794,947	0.606
1983	371,323	0.300	422,065	0.293	3,553,822	0.329	479,291	0.329	973,056	0.390	5,445,431	0.641
1984	368,374	0.430	378,268	0.429	789,515	0.266	467,064	0.430	1,745,872	0.450	1,661,525	0.645
1985	388,339	0.610	613,132	0.603	1,272,721	0.852	498,293	0.619	3,726,195	0.704	1,654,596	0.865
1986	316,090	0.399	77,146	0.207	1,730,541	0.721	372,643		143,087	0.446	2,823,515	0.765
1987	319,348	0.387	64,283	0.259	520,875	0.340	384,748		147,827	0.319	813,776	0.402
1988	423,024	0.344	15,018	0.809	805,754	0.326	581,361		32,384	0.809	1,387,250	0.482
1989	372,473	0.233	63,291	0.708	531,468	0.270	962,620		124,057	0.708	1,504,265	0.390
1990	187,006	0.300	28,440	0.580	395,835	0.312	342,555		82,345	0.587	597,948	0.445
1991	264,686	0.314	115,403	0.278	470,728	0.272	448,516		443,086	0.365	973,515	0.396
1992	413,056	0.209	123,052	0.309	625,422	0.178	872,859		438,313	0.372	1,642,224	0.313
1993	458,772	0.239	81,765	0.296	1,043,435	0.246	1,300,057		289,947	0.420	3,843,594	0.295
1994	497,738	0.215	57,285	0.261	1,205,383	0.205	1,441,644		291,985	0.394	4,117,430	0.287
1995	354,550	0.185	73,649	0.497	1,528,465	0.227	1,282,724		374,258	0.553	6,180,941	0.275
1996	349,266	0.320	57,143	0.487	1,066,610	0.183	1,324,394		353,393	0.522	4,266,101	0.230
1997	347,424	0.243	68,148	0.291	1,047,979	0.174	1,183,785		403,789	0.345	4,045,191	0.217
1998	244,738	0.138	106,153	0.343	1,012,251	0.250	940,659		606,743	0.369	6,390,569	0.280
1999	98,699	0.221	56,808	0.432	657,069	0.184	503,005		358,131	0.514	2,899,063	0.271
2000	111,410	0.193	20,477	0.249	656,299	0.196	585,453		119,230	0.374	3,159,977	0.268
2001	116,358	0.211	19,278	0.302	467,863	0.187	405,872		95,356	0.355	1,714,137	0.231
2002	138,475	0.088	54,462	0.246	428,249	0.180	607,223		280,393	0.271	1,657,626	0.233
2003	157,905	0.408	56,438	0.261	382,113	0.185	569,760		328,286	0.281	1,302,727	0.217
2004	110,329	0.119	81,847	0.259	360,469	0.190	503,163		304,521	0.326	1,168,984	0.229
2005	99,988	0.208	74,152	0.271	557,898	0.181	379,858		379,636	0.310	1,997,565	0.244
2006	121,177	0.206	95,019	0.207	696,553	0.174	450,708		360,127	0.249	2,313,846	0.204

Year	Hbt_AB1	Hbt_CV	Cbt_AB1	Cbt_CV	Priv_AB1	Priv_CV	Hbt_LBS	Hbt_CV	Cbt_LBS	Cbt_CV	Priv_LBS	Priv_CV
2007	110,314	0.571	64,282	0.202	537,811	0.166	313,255		227,916	0.234	1,992,092	0.197
2008	57,569	0.244	25,413	0.388	418,097	0.221	222,711		154,118	0.412	1,955,043	0.248
2009	75,998	0.092	29,388	0.398	418,994	0.184	491,339		205,165	0.415	2,416,245	0.205
2010	51,514	0.055	7,674	0.423	256,270	0.219	284,081		51,635	0.501	1,478,530	0.238
2011	50,656	0.051	10,449	0.434	380,196	0.200	309,919		84,424	0.481	2,196,484	0.224
2012	54,283	0.092	27,758	0.429	448,726	0.186	440,874		273,939	0.439	2,373,024	0.223
2013	43,743	0.050	19,921	0.464	578,628	0.186	240,316		195,032	0.485	3,120,266	0.222
2014	35,511	0.050	11,271	0.207	587,008	0.177	195,438		83,080	0.255	3,845,957	0.227
2015	63,033	0.051	28,729	0.125	713,784	0.151	356,570		225,254	0.159	4,444,967	0.184
2016	61,137	0.052	33,720	0.097	456,092	0.168	352,210		291,691	0.144	3,145,450	0.209
2017	60,068	0.073	36,875	0.108	564,237	0.158	344,966		293,707	0.149	3,610,785	0.191
2018	62,595	0.052	25,772	0.153	634,352	0.154	371,114		226,640	0.170	4,289,647	0.184
2019	67,126	0.059	28,781	0.149	941,672	0.172	417,573		236,529	0.191	5,800,148	0.199

**Table 4.12.7.** Total recreational landings estimates (AB1) for Gulf of Mexico Red Snapper combined across all surveys (MRIP and SRHS) by year and mode for the **Central region**. Estimates and their associated coefficients of variation (CV) are provided for recreational landings in numbers of fish (AB1) and in pounds whole weight (LBS). CVs are not available in weight units for headboat mode starting in 1986.

Year	Hbt_AB1	Hbt_CV	Cbt_AB1	Cbt_CV	Priv_AB1	Priv_CV	Hbt_LBS	Hbt_CV	Cbt_LBS	Cbt_CV	Priv_LBS	Priv_CV
1981	44,131	0.820	72,175	0.820	1,814,671	0.550	104,900	0.830	152,779	0.823	3,171,304	0.593
1982	247,419	0.430	409,279	0.420	211,587	0.430	310,332	0.431	721,369	0.589	481,274	0.559
1983	475,424	0.320	760,147	0.320	751,639	0.560	948,069	0.362	1,175,692	0.357	1,035,353	0.618
1984	132,091	0.370	211,197	0.370	272,732	0.600	343,976	0.473	378,253	0.408	312,352	0.632
1985	149,394	0.380	238,864	0.380	612,117	0.550	341,450	0.397	565,477	0.469	1,552,825	0.640
1986	14,903	0.888	507,401	0.210	261,562	0.680	34,204		1,821,590	0.261	1,030,043	0.719
1987	9,256	0.710	457,049	0.240	491,587	0.260	25,022		1,383,726	0.280	1,226,559	0.357
1988	12,881	0.218	358,245	0.320	365,960	0.480	30,605		1,110,397	0.367	1,013,440	0.513
1989	10,357	0.241	203,867	0.270	588,397	0.750	22,824		586,813	0.449	1,834,497	0.810
1990	15,393	0.191	143,525	0.330	348,726	0.370	35,331		759,517	0.428	826,123	0.418
1991	15,349	0.265	189,578	0.210	806,726	0.250	34,585		556,070	0.300	2,405,285	0.345
1992	33,832	0.190	352,497	0.180	1,422,294	0.200	77,060		1,069,803	0.329	4,193,230	0.234
1993	36,735	0.153	835,952	0.340	1,434,811	0.190	82,788		2,853,069	0.360	5,615,766	0.275
1994	28,771	0.192	373,415	0.210	1,002,018	0.240	83,204		1,488,624	0.243	4,356,660	0.298
1995	22,980	0.144	297,069	0.270	646,795	0.260	74,562		948,406	0.303	2,609,813	0.352
1996	28,314	0.086	423,073	0.310	506,756	0.200	84,173		1,833,650	0.348	1,867,540	0.325
1997	48,398	0.135	543,756	0.150	817,821	0.200	120,501		2,690,301	0.221	3,823,800	0.279
1998	76,455	0.140	871,474	0.100	563,447	0.210	183,412		3,544,826	0.118	2,345,196	0.316
1999	64,725	0.175	632,460	0.100	1,301,022	0.230	187,746		2,856,854	0.117	6,801,667	0.311
2000	56,399	0.108	376,376	0.080	864,523	0.210	173,964		1,744,329	0.094	3,864,135	0.251
2001	50,343	0.128	396,042	0.090	1,392,687	0.220	164,165		1,815,952	0.106	8,187,188	0.281
2002	74,945	0.156	556,133	0.090	1,871,975	0.200	217,093		2,571,420	0.112	9,070,895	0.253
2003	70,539	0.250	526,142	0.090	1,288,415	0.190	220,615		2,504,005	0.174	6,016,086	0.257
2004	62,020	0.246	531,741	0.090	1,633,282	0.270	185,771		1,862,784	0.097	6,125,700	0.297
2005	41,612	0.249	385,562	0.100	899,696	0.240	128,016		1,300,106	0.109	3,938,056	0.310
2006	46,744	0.385	388,459	0.110	985,369	0.200	122,689		1,239,569	0.117	3,421,054	0.253
2007	62,842	0.427	475,791	0.110	1,526,397	0.220	171,338		1,515,067	0.120	4,952,465	0.283
2008	60,630	0.087	265,441	0.120	898,069	0.170	180,280		1,024,999	0.134	4,043,048	0.199

Year	Hbt_AB1	Hbt_CV	Cbt_AB1	Cbt_CV	Priv_AB1	Priv_CV	Hbt_LBS	Hbt_CV	Cbt_LBS	Cbt_CV	Priv_LBS	Priv_CV
2009	78,421	0.055	205,255	0.160	1,079,273	0.210	300,227		1,102,839	0.179	4,596,019	0.231
2010	33,932	0.063	68,837	0.170	1,032,623	0.310	136,540		374,822	0.191	5,326,288	0.325
2011	66,156	0.051	153,432	0.190	1,242,753	0.200	306,287		954,409	0.202	7,971,276	0.225
2012	51,710	0.081	150,032	0.170	1,160,659	0.210	265,255		1,012,090	0.187	9,099,821	0.228
2013	41,303	0.050	165,648	0.350	2,091,560	0.310	192,471		1,132,367	0.367	14,466,985	0.320
2014	40,547	0.050	35,280	0.270	893,063	0.210	176,566		225,564	0.286	6,119,131	0.228
2015	42,346	0.052	204,965	0.230	1,023,321	0.230	204,629		1,331,390	0.250	6,711,504	0.250
2016	35,553	0.051	217,938	0.220	1,281,042	0.140	162,091		1,653,817	0.233	7,849,149	0.172
2017	50,271	0.051	239,362	0.260	2,568,119	0.190	211,776		1,486,665	0.274	15,859,962	0.217
2018	56,764	0.051	229,198	0.230	1,751,099	0.240	244,814		1,450,586	0.243	10,520,171	0.253
2019	41,097	0.053	282,023	0.270	1,946,996	0.200	163,298		1,672,666	0.286	10,841,563	0.231

**Table 4.12.8.** Total recreational landings estimates (AB1) for Gulf of Mexico Red Snapper combined across all surveys (MRIP and SRHS) by year and mode for the **East region**. Estimates and their associated coefficients of variation (CV) are provided for recreational landings in numbers of fish (AB1) and in pounds whole weight (LBS). CVs are not available in weight units for headboat mode starting in 1986.

Year	Hbt_AB1	Hbt_CV	Cbt_AB1	Cbt_CV	Priv_AB1	Priv_CV	Hbt_LBS	Hbt_CV	Cbt_LBS	Cbt_CV	Priv_LBS	Priv_CV
1981	13,529	0.830	21,631	0.830	568,244	0.640	34,985	0.840	51,606	0.893	968,168	0.641
1982	2,538	1.000	4,058	1.000	11,959	0.800	3,596	1.000	9,178	1.000	29,420	0.845
1983	23,342	0.410	37,321	0.410	580,760	1.000	65,432	0.512	56,543	0.410	1,294,876	1.000
1984	18,865	0.680	31,915	0.640	21,342	0.720	53,916	0.695	63,097	0.642	45,675	0.766
1985	6,866	0.780	11,182	0.770	157,060	0.710	24,922	0.808	28,496	0.773	445,067	0.722
1986	1,461	0.594	61,607	0.510	181,242	0.500	3,644		287,385	0.549	494,520	0.516
1987	429	0.759	3,429	0.900	106,125	0.530	1,274		7,350	0.919	314,634	0.531
1988	951	0.668	5,934	0.660	49,105	0.490	2,195		19,082	0.663	167,438	0.491
1989	440	0.573	11,474	1.000	142,386	0.690	1,004		49,037	1.000	322,181	0.690
1990	146	0.215	0	0.000	42,071	0.530	429		0		148,042	0.530
1991	231	0.081	75	1.000	17,216	0.610	576		187	1.000	67,366	0.610
1992	41	0.115	2,627	0.640	3,580	0.710	152		6,860	0.767	10,015	0.710
1993	540	0.095	0	0.000	0	0.000	1,557		0		0	
1994	227	0.241	57	1.000	0	0.000	615		202	1.000	0	
1995	98	0.491	0	0.000	3,298	1.000	350		0		15,433	1.000
1996	74	0.428	387	1.000	36,610	0.640	225		1,632	1.000	96,980	0.644
1997	41	0.334	1,729	0.750	0	0.000	137		8,657	0.756	0	
1998	304	0.586	8,037	0.690	0	0.000	685		22,864	0.697	0	
1999	2,707	0.552	802	0.460	11,548	0.520	8,222		2,776	0.509	39,730	0.554
2000	1,241	0.608	397	0.750	2,321	1.000	3,877		1,446	0.750	8,914	1.000
2001	946	0.610	1,516	0.530	0	0.000	3,454		5,369	0.613	0	
2002	176	0.482	523	0.530	7,709	0.720	493		1,729	0.530	30,192	0.721
2003	482	0.413	1,599	0.390	2,828	0.800	1,529		5,289	0.397	10,343	0.801
2004	1,462	0.327	440	0.470	7,039	0.920	4,348		1,576	0.479	22,213	0.920
2005	5,179	0.257	1,743	0.450	81,014	0.600	18,468		5,732	0.459	390,336	0.643
2006	1,138	0.264	10,948	0.860	18,542	0.790	2,845		35,052	0.863	59,250	0.791
2007	761	0.250	840	0.740	41,336	0.820	2,416		2,550	0.740	142,701	0.830
2008	1,356	0.066	3,285	0.610	5,624	1.000	4,965		12,472	0.615	28,942	1.000



Year	Hbt_AB1	Hbt_CV	Cbt_AB1	Cbt_CV	Priv_AB1	Priv_CV	Hbt_LBS	Hbt_CV	Cbt_LBS	Cbt_CV	Priv_LBS	Priv_CV
2009	3,169	0.055	1,893	0.620	18,935	0.600	14,334		10,482	0.649	61,133	0.600
2010	2,011	0.098	4,390	0.760	3,200	0.720	8,909		27,534	0.771	19,788	0.720
2011	3,031	0.065	0	0.000	16,390	0.660	14,362		0		81,478	0.661
2012	2,468	0.054	3,002	0.820	14,641	0.720	17,955		18,651	0.820	94,788	0.746
2013	2,682	0.050	487	0.760	3,574	0.790	12,493		2,987	0.768	21,457	0.790
2014	2,210	0.050	3,890	0.660	5,175	0.750	10,289		28,612	0.664	35,204	0.767
2015	3,116	0.050	8,019	0.680	1,901	1.000	19,032		48,168	0.689	14,097	1.000
2016	2,896	0.050	8,143	0.540	27,199	0.620	12,278		58,200	0.550	138,378	0.730
2017	8,339	0.054	19,437	0.510	77,403	0.420	27,176		103,256	0.522	348,975	0.439
2018	8,690	0.052	23,394	0.620	101,256	0.460	36,716		133,770	0.637	479,172	0.465
2019	8,645	0.051	18,048	0.310	106,202	0.530	48,405		102,888	0.328	638,478	0.538

**Table 4.12.9.** Annual discard estimates of Texas Red Snapper from the TPWD survey. Discards are provided in number of fish. Estimates for the private mode are calibrated into MRIP-FES units (SEDAR 74-DW-10).

Year	Priv_B2	Priv_CV	Cbt_B2	Cbt_CV
1981	39,958	0.990	2	0.987
1982	2,408	1.097	296	1.121
1983	695	0.133	13	0.000
1984	43,561	0.133	7	0.000
1985	118,165	0.983	27	1.112
1986	38,582	0.133	213	0.000
1987	94,389	1.215	276	1.137
1988	378,281	0.714	60	0.777
1989	176,096	0.846	81	0.939
1990	289,742	0.882	25	1.000
1991	384,542	1.041	821	1.023
1992	269,080	0.488	336	1.001
1993	217,646	0.556	5,732	1.000
1994	842,027	0.708	19,619	0.774
1995	1,243,035	0.702	9,231	0.825
1996	332,408	0.597	11,099	0.725
1997	372,886	0.639	6,105	0.709
1998	465,805	0.792	5,186	0.838
1999	1,518,422	0.524	2,065	0.588
2000	535,711	0.530	4,037	0.601
2001	424,690	0.577	10,324	0.640
2002	739,226	0.788	11,094	0.815
2003	1,613,358	0.690	6,389	0.712
2004	3,023,997	0.907	20,476	0.914
2005	1,828,615	0.650	26,180	0.772
2006	1,840,180	0.501	21,767	0.525
2007	771,231	0.488	22,688	0.511
2008	1,294,597	0.604	17,249	0.704
2009	839,889	0.583	6,424	0.602
2010	1,041,368	1.113	21,966	1.098
2011	1,128,201	0.685	4,321	0.777
2012	489,650	0.642	3,434	0.652
2013	1,523,352	0.548	7,100	0.608
2014	625,385	0.344	4,066	0.396
2015	753,132	0.311	6,018	0.329
2016	118,857	0.289	2,652	0.310
2017	320,400	0.274	2,514	0.303
2018	380,821	0.302	2,810	0.391
2019	844,184	0.266	13,594	0.342

**Table 4.12.10.** Estimated SRHS headboat discards of Gulf of Mexico Red Snapper. Discards are provided in number of fish. CVs for headboat mode (1981-2007) do not include uncertainty around the estimated TX headboat discards and are calculated from MRIP LA data.

Year	West	West_CV	Central	Central_CV	East	East_CV
1981	0	0.000				
1982	16,950	0.986				
1983	0	0.724				
1984	19,583	1.000				
1985	15,659	0.911				
1986	2,854	0.403	137	0.630	119	0.450
1987	2,431	0.844	549	0.400	60	1.000
1988	9,278	0.858	1,485	0.860	0	0.000
1989	7,356	0.983	1,135	0.450	0	0.000
1990	114,389	0.670	5,508	0.400	0	0.000
1991	87,510	0.328	10,101	0.290	0	0.000
1992	102,003	0.369	19,402	0.200	5	0.680
1993	102,382	0.322	7,273	0.450	0	0.000
1994	254,274	0.316	13,405	0.240	66	1.000
1995	116,361	0.492	19,777	0.430	0	0.000
1996	150,719	0.468	20,721	0.290	0	0.000
1997	85,010	0.330	48,054	0.250	4	1.000
1998	30,061	0.489	37,799	0.110	34	0.530
1999	6,075	0.537	55,915	0.090	1,889	0.780
2000	14,753	0.344	48,138	0.080	236	0.740
2001	24,748	0.561	46,240	0.100	503	0.730
2002	26,039	0.361	47,613	0.090	0	0.000
2003	45,140	0.282	48,924	0.090	253	0.900
2004	65,341	0.307	45,552	0.090	672	0.530
2005	72,082	0.317	39,288	0.090	1,359	0.600
2006	70,060	0.263	61,514	0.110	537	0.530
2007	58,531	0.227	57,591	0.110	591	0.630
2008	41,534	0.240	94,052	0.090	3,919	0.066
2009	30,974	0.090	94,201	0.050	5,841	0.055
2010	18,411	0.060	52,800	0.060	1,530	0.098
2011	23,092	0.050	82,104	0.050	6,295	0.065
2012	15,908	0.090	71,576	0.080	2,099	0.054
2013	9,849	0.050	80,013	0.050	1,575	0.050
2014	8,567	0.050	59,827	0.050	1,820	0.050
2015	9,714	0.050	53,346	0.050	1,489	0.050
2016	9,782	0.050	81,816	0.050	11,350	0.050
2017	10,278	0.070	115,406	0.050	15,268	0.054
2018	9,502	0.050	95,229	0.050	14,257	0.052
2019	11,312	0.060	77,428	0.050	12,680	0.051

**Table 4.12.11.** Total recreational discard estimates (B2) for Gulf of Mexico Red Snapper combined across all surveys (MRIP, TPWD, LA Creel, and SRHS) by year and mode for the **West region**. Associated coefficients of variation (CV) are also provided.

Year	Hbt	Hbt_CV	Cbt	Cbt_CV	Priv	Priv_CV
1981	0	0.000	2	0.000	63,443	0.587
1982	18,086	0.986	13,299	0.986	6,491	0.636
1983	132	0.724	1,526	0.724	695	1.047
1984	19,583	1.000	7	1.000	43,561	0.876
1985	15,659	0.911	27	0.911	204,990	0.721
1986	2,854	0.403	2,566	0.403	38,582	0.938
1987	2,431	0.844	1,802	0.844	120,038	0.980
1988	9,278	0.858	1,213	0.858	529,273	0.549
1989	7,356	0.983	4,604	0.983	371,122	0.550
1990	114,389	0.670	64,074	0.670	422,258	0.707
1991	87,510	0.328	140,526	0.328	410,625	0.973
1992	102,003	0.369	111,920	0.369	450,630	0.334
1993	102,382	0.322	67,206	0.322	528,829	0.319
1994	254,274	0.316	107,784	0.316	1,213,187	0.530
1995	116,361	0.492	89,025	0.492	1,942,650	0.480
1996	150,719	0.468	90,822	0.468	413,058	0.493
1997	85,010	0.330	61,416	0.330	488,430	0.507
1998	30,061	0.489	48,023	0.489	791,668	0.529
1999	6,075	0.537	12,877	0.537	2,037,391	0.403
2000	14,753	0.344	9,987	0.344	725,964	0.403
2001	24,748	0.561	15,101	0.561	514,604	0.498
2002	26,039	0.361	37,719	0.361	787,611	0.739
2003	45,140	0.282	59,423	0.282	1,752,181	0.676
2004	65,341	0.307	178,530	0.307	3,186,929	0.863
2005	72,082	0.317	196,889	0.317	2,024,526	0.594
2006	70,060	0.263	202,335	0.263	2,240,383	0.419
2007	58,531	0.227	125,620	0.227	1,070,212	0.371
2008	41,534	0.240	68,196	0.474	1,607,619	0.508
2009	30,974	0.090	33,124	0.508	1,125,424	0.451
2010	18,411	0.060	22,836	1.000	1,052,869	1.060
2011	23,092	0.050	7,385	0.759	1,335,234	0.594
2012	15,908	0.090	19,160	0.423	689,976	0.491
2013	9,849	0.050	27,707	0.536	1,836,243	0.474
2014	8,567	0.050	6,976	0.344	1,054,684	0.329
2015	9,714	0.050	17,781	0.264	1,283,348	0.328
2016	9,782	0.050	13,055	0.238	528,696	0.328
2017	10,278	0.070	9,921	0.178	839,758	0.278
2018	9,502	0.050	6,944	0.213	865,636	0.278
2019	11,312	0.060	33,960	0.229	1,692,191	0.243

**Table 4.12.12.** Total recreational discard estimates (B2) for Gulf of Mexico Red Snapper combined across all surveys (MRIP and SRHS) by year and mode for the **Central region**. Associated coefficients of variation (CV) are also provided.

Year	Hbt	Hbt_CV	Cbt	Cbt_CV	Priv	Priv_CV
1981	305	0.710	488	0.710	179,403	0.730
1982	4,839	1.000	7,736	1.000	13,169	0.660
1983	0	0.000	0	0.000	4,470	1.000
1984	2,367	1.000	3,784	1.000	0	0.000
1985	1,429	1.000	2,285	1.000	925	1.000
1986	137	0.630	7,325	0.630	13,528	0.850
1987	549	0.400	42,598	0.400	113,799	0.370
1988	1,485	0.860	64,906	0.860	9,133	0.470
1989	1,135	0.450	35,092	0.450	323,028	0.590
1990	5,508	0.400	80,687	0.400	772,205	0.590
1991	10,101	0.290	196,019	0.290	1,587,532	0.290
1992	19,402	0.200	317,612	0.200	1,315,577	0.170
1993	7,273	0.450	260,033	0.450	1,657,182	0.230
1994	13,405	0.240	273,364	0.240	940,422	0.240
1995	19,777	0.430	401,693	0.430	226,084	0.320
1996	20,721	0.290	486,469	0.290	1,014,854	0.260
1997	48,054	0.250	848,272	0.250	2,268,032	0.250
1998	37,799	0.110	676,954	0.110	1,112,842	0.220
1999	55,915	0.090	858,452	0.090	2,683,990	0.220
2000	48,138	0.080	504,744	0.080	2,562,346	0.230
2001	46,240	0.100	571,539	0.100	4,372,757	0.190
2002	47,613	0.090	555,125	0.090	6,425,866	0.220
2003	48,924	0.090	573,352	0.090	4,349,158	0.200
2004	45,552	0.090	613,631	0.090	4,505,055	0.190
2005	39,288	0.090	571,953	0.090	4,028,055	0.180
2006	61,514	0.110	803,201	0.110	4,173,109	0.160
2007	57,591	0.110	685,094	0.110	5,695,976	0.160
2008	94,052	0.090	486,489	0.110	4,356,132	0.210
2009	94,201	0.050	475,856	0.120	3,836,628	0.170
2010	52,800	0.060	226,653	0.150	4,425,910	0.190
2011	82,104	0.050	375,945	0.120	3,729,516	0.170
2012	71,576	0.080	258,458	0.120	3,971,312	0.160
2013	80,013	0.050	402,950	0.210	4,871,390	0.300
2014	59,827	0.050	281,548	0.170	3,864,994	0.220
2015	53,346	0.050	258,410	0.150	3,157,763	0.190
2016	81,816	0.050	416,808	0.190	5,482,595	0.170
2017	115,406	0.050	537,942	0.200	8,266,634	0.170
2018	95,229	0.050	422,031	0.150	5,025,444	0.190
2019	77,428	0.050	497,158	0.250	5,764,684	0.170

**Table 4.12.13.** Total recreational discard estimates (B2) for Gulf of Mexico Red Snapper combined across all surveys (MRIP and SRHS) by year and mode for the **East region**. Associated coefficients of variation (CV) are also provided.

Year	Hbt	Hbt_CV	Cbt	Cbt_CV	Priv	Priv_CV
1981	0	0.000	0	0.000	76,357	0.710
1982	247	1.000	396	1.000	0	0.000
1983	0	0.000	0	0.000	0	0.000
1984	2,248	1.000	3,594	1.000	82,405	0.790
1985	630	1.000	1,007	1.000	41,324	0.810
1986	119	0.450	17,128	0.450	11,688	0.710
1987	60	1.000	1,642	1.000	3,103	0.710
1988	0	0.000	0	0.000	35,687	0.480
1989	0	0.000	0	0.000	7,022	0.710
1990	0	0.000	0	0.000	21,540	1.000
1991	0	0.000	0	0.000	78,277	0.420
1992	5	0.680	1,018	0.680	80,073	0.440
1993	0	0.000	0	0.000	29,726	0.470
1994	66	1.000	57	1.000	38,864	0.590
1995	0	0.000	0	0.000	13,967	0.780
1996	0	0.000	0	0.000	35,811	0.490
1997	4	1.000	543	1.000	25,990	1.000
1998	34	0.530	3,075	0.530	65,605	0.590
1999	1,889	0.780	1,918	0.780	49,859	0.460
2000	236	0.740	259	0.740	67,724	0.690
2001	503	0.730	2,759	0.730	5,729	1.000
2002	0	0.000	0	0.000	6,874	1.000
2003	253	0.900	2,878	0.900	4,989	0.720
2004	672	0.530	693	0.530	92,594	0.750
2005	1,359	0.600	1,566	0.600	129,180	0.480
2006	537	0.530	17,678	0.530	55,316	0.540
2007	591	0.630	2,232	0.630	43,270	0.520
2008	3,919	0.066	16,106	0.760	40,481	0.620
2009	5,841	0.055	17,656	0.650	102,835	0.670
2010	1,530	0.098	4,049	0.770	129,468	0.560
2011	6,295	0.065	1,948	0.950	1,500,578	0.980
2012	2,099	0.054	1,344	0.890	14,288	1.000
2013	1,575	0.050	11,196	0.920	8,516	0.490
2014	1,820	0.050	9,079	0.540	49,385	0.590
2015	1,489	0.050	15,142	0.660	24,001	0.630
2016	11,350	0.050	42,282	0.430	708,161	0.660
2017	15,268	0.054	160,004	0.710	260,727	0.340
2018	14,257	0.052	59,027	0.370	647,039	0.400
2019	12,680	0.051	25,160	0.380	395,152	0.360

**Table 4.12.14.** Summary of weight measurements (pounds whole weight) from MRIP-intercepted Red Snapper by state and year. Summaries include the number of fish weighed by MRIP (Fish), the number of angler trips from which those fish were weighed (Trp), and the minimum (Min), geometric mean (Avg), and maximum (Max) size of fish weights. LA weights are available from MRIP only until 2013.

Year	West					Central					East				
	Fish	Trp	Min	Avg	Max	Fish	Trp	Min	Avg	Max	Fish	Trp	Min	Avg	Max
1981	208	35	0.4	3.1	15.4	299	49	0.2	2.7	22.0	54	13	0.2	1.7	11.0
1982	329	52	0.2	1.6	15.7	557	126	0.2	2.1	10.8	6	3	0.9	3.4	11.5
1983	1,640	255	0.2	1.8	51.6	906	178	0.2	1.7	12.9	106	66	0.7	3.9	27.4
1984	986	191	0.0	3.5	50.0	304	73	0.2	1.9	9.5	61	28	0.2	2.3	8.0
1985	878	136	0.1	1.6	19.7	426	111	0.2	2.3	16.6	39	22	0.2	2.7	9.8
1986	1,075	167	0.1	1.8	27.9	904	257	0.4	3.4	22.2	99	43	1.5	4.5	19.4
1987	820	132	0.2	1.8	22.9	1,155	214	0.2	2.8	26.1	32	12	0.7	4.6	19.2
1988	453	122	0.1	1.7	25.5	194	158	0.3	2.9	10.8	19	15	2.5	3.9	7.1
1989	389	96	0.2	2.1	17.3	558	119	0.5	3.0	22.7	24	5	0.9	1.9	4.0
1990	482	123	0.2	1.9	12.9	453	93	0.7	3.0	25.5	5	4	1.6	7.1	11.4
1991	944	160	0.2	3.0	35.2	1,364	198	0.8	3.1	30.6	5	4	2.0	4.7	8.3
1992	1,221	242	0.6	3.0	29.9	2,743	395	0.4	3.3	38.0	11	7	1.5	4.7	17.7
1993	1,093	221	0.3	3.1	22.1	1,629	266	0.6	3.7	27.0	0	0	0.0	0.0	0.0
1994	1,439	292	0.1	3.3	29.0	1,275	232	0.6	3.9	27.7	1	1	4.0	4.0	4.0
1995	2,194	451	0.0	3.4	23.8	760	159	1.0	3.6	21.8	1	1	15.2	15.2	15.2
1996	1,723	371	0.2	3.8	29.0	873	185	0.3	4.6	31.2	13	7	1.9	5.1	15.0
1997	1,653	364	0.8	3.9	23.8	2,501	363	1.1	5.3	43.9	21	6	0.9	4.9	26.7
1998	1,591	322	0.2	4.4	26.3	4,515	466	0.3	4.0	32.0	32	11	0.8	2.4	4.9
1999	960	225	0.4	4.4	34.3	9,717	849	0.2	5.7	52.5	36	13	1.3	4.4	25.9
2000	1,279	281	0.3	4.0	26.3	10,058	886	0.6	4.6	50.3	5	4	2.2	4.5	8.9
2001	1,015	236	0.3	3.4	22.3	8,102	680	0.7	4.8	36.1	22	8	1.9	6.2	14.9
2002	1,361	273	0.5	4.2	20.2	9,560	719	1.0	4.6	40.6	19	7	2.0	4.2	13.6
2003	1,453	275	0.3	4.2	29.2	8,507	775	1.1	4.7	41.1	59	12	1.5	3.4	8.2
2004	1,429	268	0.2	3.3	21.5	8,361	947	1.1	3.5	30.4	21	9	2.4	4.5	9.0
2005	1,598	327	0.3	3.8	25.5	6,975	765	1.3	3.3	23.8	77	23	1.8	3.7	10.8
2006	2,271	426	0.6	3.5	28.1	5,776	631	0.6	3.1	25.9	38	10	1.8	3.6	13.9
2007	1,879	322	0.5	3.6	19.1	6,453	700	0.7	3.1	25.9	31	10	2.2	3.6	8.5
2008	1,052	232	0.2	4.6	31.5	3,262	482	1.5	3.9	21.1	34	11	1.7	5.1	16.6
2009	1,243	254	0.1	5.7	23.8	1,904	330	1.9	5.2	24.3	16	9	2.8	5.3	8.4
2010	645	131	0.3	5.9	21.1	1,884	290	1.1	5.4	27.0	34	8	2.3	6.7	13.3
2011	943	197	0.3	5.8	19.5	1,918	303	1.1	6.1	27.3	15	5	4.1	6.1	12.5
2012	947	203	0.6	6.4	26.5	2,135	348	0.6	7.0	25.4	26	5	1.9	6.3	13.2
2013	1,287	264	0.4	5.8	29.3	1,579	351	1.2	7.6	24.4	31	6	2.4	7.3	13.4
2014	1,685	293	0.4	7.2	28.1	1,585	346	1.6	6.9	22.0	47	13	2.2	6.8	13.1
2015	2,499	432	0.3	6.6	22.8	2,242	497	0.4	6.7	25.8	45	7	3.2	6.3	17.0
2016	1,818	310	0.4	7.0	24.3	2,873	660	0.9	7.0	31.9	66	24	1.3	4.7	15.0
2017	2,682	473	0.6	6.9	28.2	2,766	694	0.4	6.5	25.4	176	43	0.7	4.1	22.0
2018	3,110	580	0.2	7.3	25.6	2,664	555	1.1	6.7	25.4	164	28	1.8	5.5	19.4
2019	2,858	541	0.3	6.5	25.9	3,363	678	1.2	6.3	25.4	193	42	1.6	5.5	15.0

**Table 4.12.15.** Summary of weight measurements (pounds whole weight) from SRHS-intercepted Red Snapper by state and year. Summaries include the number of fish weighed by SRHS (Fish), the number of angler trips from which those fish were weighed (Trips), and the minimum (Min), geometric mean (Mean), and maximum (Max) size of fish weights.

Year	West					Central					East				
	Fish	Min	Mean	SD	Max	Fish	Min	Mean	SD	Max	Fish	Min	Mean	SD	Max
1986	6,252	0.02	1.32	1.674	24.91	141	0.40	2.26	2.378	17.42	23	1.04	4.00	3.994	15.21
1987	5,978	0.18	1.35	1.513	30.75	191	0.40	2.97	5.027	39.68	1	3.31	3.31		3.31
1988	4,607	0.06	1.88	2.633	27.56	195	0.66	2.40	2.373	19.84	1	1.87	1.87		1.87
1989	6,320	0.22	1.64	1.935	22.38	280	0.33	2.24	2.097	15.06	6	2.65	6.30	3.312	11.35
1990	4,263	0.33	1.87	1.802	27.14	330	0.49	2.12	1.532	14.24	3	11.11	16.15	5.683	22.31
1991	3,422	0.02	1.96	1.706	29.63	496	0.62	2.25	1.649	12.74	1	3.57	3.57		3.57
1992	7,877	0.49	2.29	2.048	30.05	682	0.49	2.16	1.446	12.37	1	5.25	5.25		5.25
1993	7,056	0.73	2.67	2.600	33.16	385	0.66	2.25	1.617	10.80					
1994	6,645	0.68	2.92	2.717	23.55	806	0.29	3.00	2.481	21.34	510	0.35	2.92	2.562	14.75
1995	8,327	0.57	3.60	3.345	28.15	441	1.06	3.18	2.856	24.65					
1996	5,261	0.04	3.40	2.770	24.63	496	0.53	2.98	2.150	19.09					
1997	3,999	0.82	4.08	2.997	25.51	1,142	0.51	2.44	1.661	20.70					
1998	6,557	0.09	3.94	3.447	32.61	2,158	0.79	2.44	1.289	19.22					
1999	3,285	1.10	4.79	3.592	30.23	839	0.60	2.88	1.500	15.01	45	1.54	3.17	1.191	7.08
2000	3,196	0.07	3.73	2.597	29.37	1,131	0.44	3.04	1.837	15.17	5	2.98	3.61	0.529	4.21
2001	2,535	0.22	3.83	2.694	24.80	649	0.95	3.29	2.138	17.72	5	5.78	9.06	2.635	11.68
2002	2,385	0.15	4.06	2.791	24.76	1,250	1.17	2.91	1.583	25.35					
2003	2,008	0.02	3.83	3.083	22.22	1,086	1.41	3.13	1.809	21.52	3	2.84	3.51	0.577	3.90
2004	808	1.43	3.44	2.752	25.22	543	1.72	3.11	1.627	18.89	1	2.78	2.78		2.78
2005	1,016	1.54	3.50	2.692	23.74	301	1.57	3.09	1.847	18.08	2	2.16	2.25	0.125	2.34
2006	767	0.04	3.70	3.613	40.39	464	1.15	2.58	1.146	13.32	17	1.87	2.35	0.703	4.67
2007	768	0.62	3.23	1.814	16.29	1,264	0.64	2.66	0.971	11.62	16	1.72	2.95	0.791	5.25
2008	401	1.10	4.40	2.487	24.03	1,221	0.49	2.95	1.108	10.49	2	8.02	8.92	1.263	9.81
2009	866	0.99	6.26	3.281	23.59	911	0.60	3.78	2.006	14.73	36	2.05	4.22	1.708	7.89
2010	796	1.81	5.43	2.614	16.25	687	1.85	3.94	2.024	16.05	21	2.18	6.29	3.863	16.95
2011	978	1.92	6.79	3.094	17.33	722	0.40	4.63	2.580	20.88	15	3.09	5.95	1.705	8.86
2012	456	1.03	8.34	3.380	25.88	575	0.60	5.61	4.904	44.84	32	2.01	7.69	3.759	18.98
2013	2,299	0.11	5.68	2.441	23.46	1,057	0.46	4.80	3.063	20.85	19	2.27	5.08	3.367	13.29
2014	4,773	0.49	5.88	2.376	20.24	2,101	0.09	5.20	3.494	23.77	49	2.07	7.87	4.535	17.84
2015	4,013	0.33	6.00	2.382	22.49	2,138	0.46	5.27	3.529	25.35	126	1.96	6.01	4.304	18.01
2016	3,793	0.46	5.88	2.346	26.30	674	1.41	5.42	3.942	36.73	32	1.87	4.24	3.264	14.00
2017	2,887	0.60	5.94	2.352	25.02	754	1.26	4.48	2.867	24.78	78	1.98	3.36	2.427	16.62
2018	3,936	0.49	6.41	2.847	29.01	650	1.61	4.62	3.200	21.89	94	1.76	4.23	1.948	10.87
2019	3,788	0.42	6.12	2.612	22.75	1,413	0.62	4.06	2.726	23.77	96	2.25	5.73	2.645	14.22



**Table 4.12.16.** Associated sample sizes by stock and mode for length compositions in the three time periods shown in Figure 4.13.8.

	West			Central			East		
	CB	HB	PR	CB	HB	PR	CB	HB	PR
<b>1981 - 2006</b>	8,180	92,512	24,060	83,159	13,998	6,882	228	624	130
<b>2007 - 2012</b>	4,735	4,265	6,884	15,833	5,380	2,007	347	122	71
<b>2013 - 2019</b>	6,101	25,489	12,910	13,101	8,787	8,963	1,267	494	597

**Table 4.12.17.** Temporal aggregation of modes within the Eastern Stock to meet minimum sample size thresholds for estimating length and age compositions.

Time Period	Length Samples			Age Samples		
	E_HB	E_CB	E_PR	E_HB	E_CB	E_PR
1981-2006	812	228	130	211	141	5
2007-2009	423	105	30	371	73	13
2010-2012	883	242	41	627	209	26
2013-2015	482	356	30	461	243	19
2016-2017	416	261	428	197	90	277
2018	328	304	73	236	207	40
2019	294	346	66	189	207	14

**Table 4.12.18.** Annual number of recreational headboat (HB), charter boat (CB), and private (PR) age samples by stock.

Year	W HB	W CB	W PR	C HB	C CB	C PR	E HB	E CB	E PR
1986	348	0	0	1	0	0	1	0	0
1987	146	0	0	0	0	0	0	0	0
1988	350	0	0	1	0	0	0	0	0
1989	82	0	0	0	0	0	1	0	0
1990	36	0	0	0	0	0	0	0	0
1991	102	526	0	20	237	0	0	2	0
1992	26	485	0	70	347	2	5	0	0
1993	910	189	24	254	370	0	0	62	0
1994	385	0	0	170	423	0	53	0	0
1995	10	0	0	11	360	0	0	0	0
1996	0	0	0	95	100	0	0	0	0
1997	0	0	0	95	56	0	1	0	0
1998	957	135	212	669	945	237	1	1	0
1999	263	97	75	351	658	581	14	0	0
2000	250	2	3	139	504	0	1	2	0
2001	74	0	0	217	377	1	1	11	0
2002	205	245	322	219	2,506	309	0	15	0
2003	139	229	600	70	6,022	353	2	35	3
2004	168	400	627	63	3,815	197	1	3	0
2005	205	422	815	48	5,089	194	52	5	0
2006	205	238	1,081	109	3,383	251	78	5	2
2007	67	475	530	185	402	64	7	14	1
2008	133	467	340	146	366	30	46	7	10
2009	428	427	323	367	520	73	318	52	2
2010	393	49	434	236	1,269	58	240	122	13
2011	660	413	130	185	1,138	80	260	73	13
2012	361	401	380	227	1,670	157	127	14	0
2013	1,471	615	313	665	1,987	113	155	21	7
2014	1,230	241	515	2,890	835	314	103	81	12
2015	998	455	381	2,337	1,807	650	203	141	0
2016	723	341	568	321	1,307	858	39	24	10
2017	1,070	529	433	385	899	581	158	66	267
2018	1,062	601	515	709	1,232	815	236	207	40
2019	1,059	382	540	770	1,331	649	189	207	14

**Table 4.12.19.** Annual number of recreational headboat (HB), charter boat (CB), and private (PR) trips sampled for ages by stock.

Year	W HB	W CB	W PR	C HB	C CB	C PR	E HB	E CB	E PR
1986	58	0	0	1	0	0	1	0	0
1987	47	0	0	0	0	0	0	0	0
1988	69	0	0	0	0	0	0	0	0
1989	27	0	0	0	0	0	1	0	0
1990	11	0	0	0	0	0	0	0	0
1991	5	29	0	10	43	0	0	1	0
1992	6	27	0	23	62	1	1	0	0
1993	107	9	1	90	69	0	0	2	0
1994	57	0	0	68	73	0	13	0	0
1995	2	0	0	8	52	0	0	0	0
1996	0	0	0	31	29	0	0	0	0
1997	0	0	0	46	11	0	1	0	0
1998	87	6	10	144	42	19	1	1	0
1999	33	1	10	74	41	12	3	0	0
2000	54	1	0	29	60	0	1	0	0
2001	19	0	0	34	52	1	1	3	0
2002	42	23	33	41	134	39	0	5	0
2003	23	32	55	24	3,973	63	2	15	3
2004	31	35	68	37	2,970	84	1	3	0
2005	28	44	106	12	4,290	55	52	5	0
2006	27	25	84	44	2,497	76	78	5	2
2007	13	51	49	46	137	22	7	14	1
2008	11	41	43	146	165	10	46	6	10
2009	50	52	50	219	242	23	318	52	2
2010	31	4	26	141	1,123	20	240	122	13
2011	44	30	20	113	674	64	260	73	13
2012	30	32	29	113	1,202	73	127	14	0
2013	119	46	34	243	1,617	58	151	20	7
2014	135	26	56	1,567	678	263	67	29	12
2015	153	41	51	280	286	134	24	22	0
2016	87	34	58	52	168	232	13	9	6
2017	80	56	53	62	129	144	24	16	63
2018	130	79	67	102	197	172	40	39	14
2019	139	44	61	125	232	150	30	45	9

**Table 4.12.20.** Summary statistics for discard length frequency data provided by Mississippi, Alabama, and Florida. Data from Mississippi, Alabama and northwest Florida (NWFL) correspond with the central stock assessment region, and southwest Florida (SWFL) corresponds with the eastern stock assessment region.

HEADBOAT FLEET																
YEAR	MISSISSIPPI				ALABAMA				NWFL				SWFL			
	<i>N</i>	<i>Min</i>	<i>Mean</i>	<i>Max</i>	<i>N</i>	<i>Min</i>	<i>Mean</i>	<i>Max</i>	<i>N</i>	<i>Min</i>	<i>Mean</i>	<i>Max</i>	<i>N</i>	<i>Min</i>	<i>Mean</i>	<i>Max</i>
2005					1197	180	306	491	1672	157	316.4	552	133	190	418.5	657
2006					1411	182	292.2	800	2038	191	317.3	634	260	207	364.3	622
2007					1165	204	314.2	459	2788	127	326.2	655	112	300	433.8	635
2009									423	214	349	684	208	241	461.1	760
2010									406	236	357.7	725	283	287	501	752
2011									578	255	410.6	750	527	304	481.1	790
2012									796	196	389.1	751	96	325	495.3	708
2013									555	240	376.1	704	84	270	457.1	720
2015									516	171	376.5	690	21	290	394.9	560
2016	21	283	366.3	510					867	190	353.1	747	358	180	358.6	675
2017	189	208	341.1	522					797	208	355.2	787	244	250	396.8	686
2018	95	284	341.2	385					636	200	360.2	870	416	215	409.4	742
2019	87	260	338.8	528					801	209	366.9	660	516	164	430.5	727
2020	78	228	322.7	371					107	248	388.2	580				
CHARTER FLEET																
YEAR	MISSISSIPPI				ALABAMA				NWFL				SWFL			
	<i>N</i>	<i>Min</i>	<i>Mean</i>	<i>Max</i>	<i>N</i>	<i>Min</i>	<i>Mean</i>	<i>Max</i>	<i>N</i>	<i>Min</i>	<i>Mean</i>	<i>Max</i>	<i>N</i>	<i>Min</i>	<i>Mean</i>	<i>Max</i>
2009									529	245	379.7	780	18	345	429.2	580
2010									1174	236	417.2	813	28	349	489.6	662
2011									1289	143	426	940	3	515	570	640
2012									885	221	431.3	954	16	300	388.8	474
2013									944	213	379.8	825	9	320	426.6	602
2015									436	205	382.9	770	123	290	457.7	630
2016	139	232	354.1	542					841	189	365.3	852	191	250	347.5	450
2017	160	204	369.4	613	42	230	403.6	800	804	159	365.9	818	239	290	404.6	724
2018	100	283	334.6	400	3	423	453	509	760	167	354.8	724	420	259	445.7	766
2019	98	258	362	636	248	149	386.2	735	781	204	372.7	819	276	230	439.7	719
2020	47	232	362.6	545					65	266	364.9	620	61	225	372.5	566

**Table 4.12.21.** Annual effort estimates for Texas and Louisiana anglers from MRIP (LA 1981-2013), LACR (LA 2014+), and TPWD (TX 1983+). All estimates for the private mode are calibrated into MRIP-FES units, the methods of which are described in SEDAR 74-DW-04 (LACR) and SEDAR 74-DW-10 (TPWD).

Year	TX		LA		
	Cbt	Priv	Cbt	Hbt	Priv
1981			82,560	7,216	2,795,268
1982			78,798	6,887	3,448,692
1983	31,110	5,717,248	91,690	8,014	3,637,251
1984	24,175	6,753,183	96,331	8,419	3,378,932
1985	30,753	7,410,952	92,596	8,093	3,420,068
1986	26,520	7,392,606	68,898		3,299,210
1987	31,108	9,354,116	86,823		3,182,763
1988	27,877	9,043,534	97,770		3,090,098
1989	43,233	8,156,959	111,340		3,279,304
1990	34,753	7,912,144	102,374		3,519,980
1991	49,848	7,910,706	112,035		3,594,434
1992	48,351	8,903,857	106,907		3,813,484
1993	54,519	9,187,859	112,686		3,930,692
1994	90,792	9,877,312	113,883		3,874,700
1995	74,051	9,902,718	115,195		3,946,252
1996	75,535	9,850,042	114,007		4,145,783
1997	95,031	8,711,458	116,288		4,330,619
1998	109,561	8,883,670	116,717		4,412,813
1999	115,950	10,706,000	118,518		4,848,823
2000	156,167	10,500,486	85,432		5,333,517
2001	140,795	8,746,968	126,340		5,447,482
2002	136,952	8,698,453	96,617		5,099,412
2003	118,479	9,264,535	129,492		5,138,240
2004	122,918	9,428,899	141,868		4,827,449
2005	101,456	8,691,226	122,463		4,326,928
2006	151,309	9,305,355	179,262		4,378,135
2007	148,673	8,054,536	142,508		4,756,911
2008	144,307	7,944,532	151,643		5,236,730
2009	118,940	8,790,021	168,141		5,730,837
2010	126,061	8,114,013	76,240		6,098,096
2011	158,261	9,064,548	96,787		5,944,122
2012	217,675	8,529,423	108,457		5,730,292
2013	146,500	9,278,528	121,871		5,476,618
2014	139,144	8,980,071	130,622		4,478,621
2015	144,344	8,455,671	159,794		4,840,531
2016	157,318	9,962,788	179,238		4,406,514
2017	187,850	8,883,595	178,723		4,549,944
2018	304,925	8,890,396	183,313		4,470,872
2019	366,757	8,478,839	168,571		4,144,552

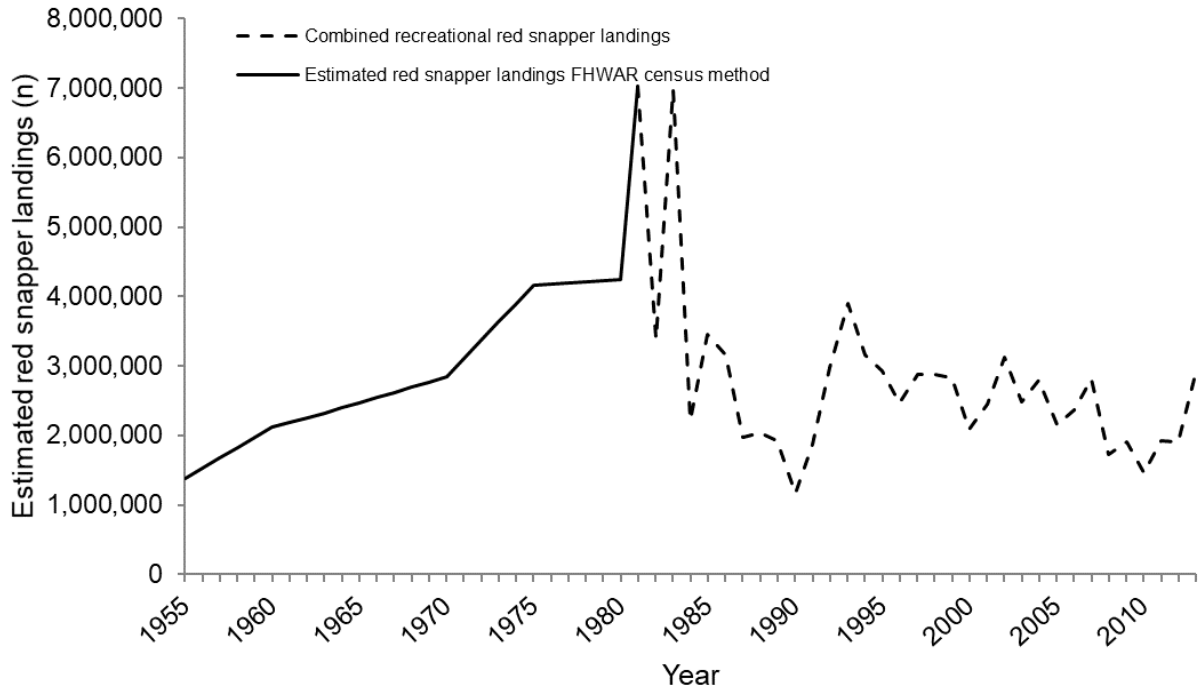
**Table 4.12.22.** Estimated SRHS headboat effort (in angler days) for Gulf of Mexico.

<b>Year</b>	<b>West</b>	<b>Central</b>	<b>East</b>
1986	62,459	101,336	138,741
1987	69,725	76,111	140,938
1988	78,087	67,648	128,300
1989	66,256	57,233	151,092
1990	65,042	60,758	153,148
1991	66,342	62,392	111,920
1992	86,129	66,180	118,622
1993	92,160	73,703	134,195
1994	113,429	69,110	135,452
1995	100,962	67,798	114,612
1996	102,840	64,336	90,577
1997	91,215	65,599	83,843
1998	85,504	66,664	118,667
1999	66,261	60,959	115,158
2000	63,347	57,106	102,225
2001	61,583	55,748	101,495
2002	73,173	55,554	86,277
2003	81,068	62,555	81,656
2004	64,990	63,494	94,936
2005	59,857	52,797	77,436
2006	75,794	66,346	57,703
2007	66,286	67,997	68,883
2008	44,133	62,118	68,058
2009	54,005	65,623	76,815
2010	47,371	41,092	70,424
2011	49,170	79,074	79,722
2012	53,615	79,611	84,205
2013	57,328	67,352	109,206
2014	52,865	73,381	119,607
2015	56,799	70,388	125,918
2016	55,368	75,716	125,932
2017	53,131	72,764	125,526
2018	53,698	73,673	119,871
2019	53,714	66,877	120,271

**Table 4.12.23.** Total recreational fishing effort (in angler trips) for Gulf of Mexico by mode and year (MRIP, SRHS, TPWD, and LA Creel). The combined private-shore mode in the LA Creel survey is allocated as private fishing. MRIP headboat estimates are used from 1981-1985 and SRHS from 1986+.

West				Central				East		
Cbt	Hbt	Priv	Total	Cbt	Hbt	Priv	Total	Cbt	Hbt	Priv
82,560	7,216	2,795,268	2,885,044	92,371	40,577	2,722,546	2,855,494	179,341	94,998	6,669,133
78,798	6,887	3,448,692	3,534,377	258,200	137,252	2,837,465	3,232,917	291,431	116,772	7,673,280
122,800	8,014	9,354,499	9,485,312	193,924	85,454	2,371,474	2,650,852	320,524	163,025	9,567,170
120,507	8,419	10,132,114	10,261,040	200,779	97,182	3,634,221	3,932,183	280,455	136,610	10,368,065
123,349	8,093	10,831,019	10,962,461	169,617	83,937	5,626,228	5,879,782	358,028	185,486	6,675,184
95,418	70,752	10,691,816	10,857,986	233,049	109,501	4,881,068	5,223,618	306,934	149,920	6,971,520
117,932	81,749	12,536,880	12,736,560	354,826	94,606	4,549,524	4,998,956	221,501	175,186	8,263,928
125,647	83,764	12,133,632	12,343,043	269,988	95,117	4,375,597	4,740,702	165,651	180,397	9,950,151
154,572	75,876	11,436,264	11,666,712	298,724	77,740	4,342,397	4,718,861	262,506	205,230	10,559,047
137,127	76,780	11,432,124	11,646,032	203,569	84,679	2,736,932	3,025,180	329,791	213,445	12,548,217
161,884	81,337	11,505,140	11,748,360	311,368	84,919	2,929,846	3,326,133	264,410	152,329	13,535,909
155,258	96,090	12,717,341	12,968,689	248,411	88,649	2,717,482	3,054,542	280,064	158,896	13,197,651
167,205	100,043	13,118,550	13,385,798	278,841	92,904	3,904,041	4,275,787	338,681	169,155	13,049,759
204,675	118,160	13,752,012	14,074,847	291,234	91,884	4,175,935	4,559,053	330,960	180,088	12,616,507
189,246	105,772	13,848,971	14,143,989	321,550	96,121	3,531,534	3,949,205	430,644	162,491	13,961,044
189,542	107,764	13,995,824	14,293,131	355,761	95,265	4,106,273	4,557,299	337,673	134,122	13,329,241
211,319	94,157	13,042,077	13,347,553	266,302	90,340	3,911,918	4,268,560	390,600	115,464	14,809,162
226,278	90,553	13,296,483	13,613,313	271,509	84,811	4,076,075	4,432,394	412,702	150,970	15,053,774
234,467	48,435	15,554,823	15,837,725	297,159	59,167	5,622,320	5,978,646	344,852	111,772	14,986,982
241,598	72,056	15,834,002	16,147,656	249,153	81,259	5,999,721	6,330,133	383,788	145,461	13,800,980
267,136	64,516	14,194,451	14,526,102	237,119	73,549	7,111,168	7,421,836	414,969	133,904	14,842,138
233,569	69,614	13,797,866	14,101,048	253,721	74,590	6,535,509	6,863,820	438,705	115,841	14,559,599
247,971	82,703	14,402,775	14,733,449	253,435	84,091	7,359,201	7,696,727	359,193	109,768	14,904,967
264,785	65,024	14,256,348	14,586,158	275,823	84,474	8,659,644	9,019,942	415,559	126,306	17,729,380
223,918	62,093	13,018,155	13,304,166	234,442	72,310	8,049,871	8,356,623	360,612	106,056	16,748,668
330,571	77,265	13,683,490	14,091,326	250,705	91,581	9,100,702	9,442,987	376,844	79,650	14,120,517
291,181	144,368	12,811,447	13,246,997	280,888	92,156	9,690,632	10,063,676	442,659	93,357	14,052,639
295,950	29,253	13,181,262	13,506,465	239,033	88,627	9,293,163	9,620,824	428,988	97,102	16,866,891
287,082	58,088	14,520,858	14,866,028	230,831	95,052	8,713,701	9,039,584	411,350	111,263	15,025,847
202,300	49,354	14,212,109	14,463,764	125,729	58,778	8,715,899	8,900,407	405,290	100,979	15,750,729
255,048	52,086	15,008,670	15,315,804	262,264	113,677	9,482,632	9,858,573	385,671	115,375	15,094,221
326,132	61,588	14,259,715	14,647,436	275,000	116,010	10,735,788	11,126,798	510,293	123,479	16,327,654
268,371	60,222	14,755,146	15,083,739	279,468	107,828	9,025,293	9,412,589	507,462	125,369	16,280,391
269,766	56,390	13,458,692	13,784,848	284,955	119,593	7,535,770	7,940,318	512,429	136,898	14,846,796
304,138	60,863	13,296,202	13,661,203	370,346	116,572	7,877,969	8,364,887	536,523	142,852	12,545,628
336,556	58,404	14,369,303	14,764,262	333,618	122,944	8,764,593	9,221,155	599,637	145,467	12,861,680
366,573	56,345	13,433,539	13,856,458	336,785	120,773	10,137,744	10,595,303	545,357	144,133	12,033,494
488,238	55,932	13,361,269	13,905,438	341,321	125,490	9,120,022	9,586,833	597,816	134,783	11,566,078
535,328	54,967	12,623,392	13,213,686	378,050	113,422	8,194,723	8,686,194	762,322	135,341	10,222,218

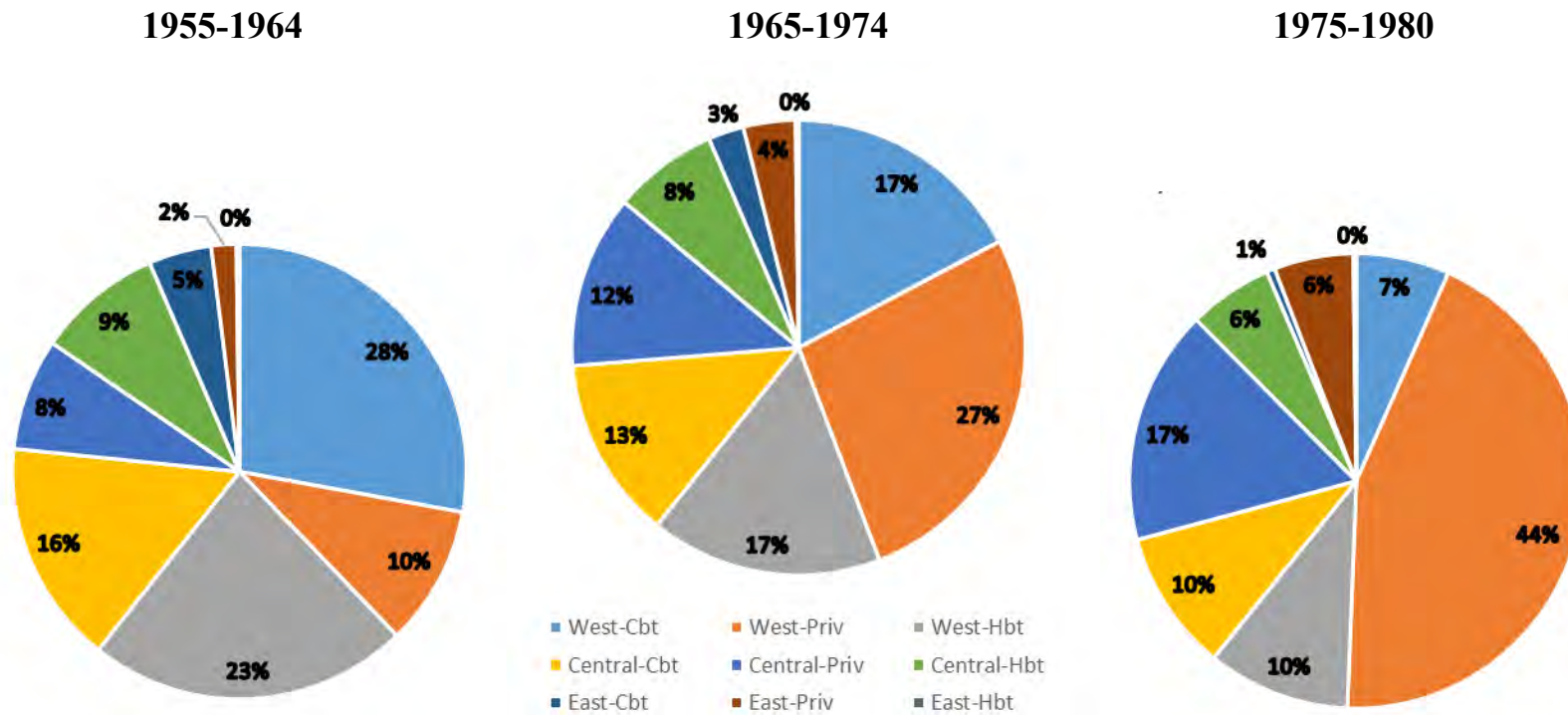
4.13 FIGURES



**Figure 4.13.1.** Historical landings in number of fish (FHWAR method using 9-year average CPUE 1981-1989).

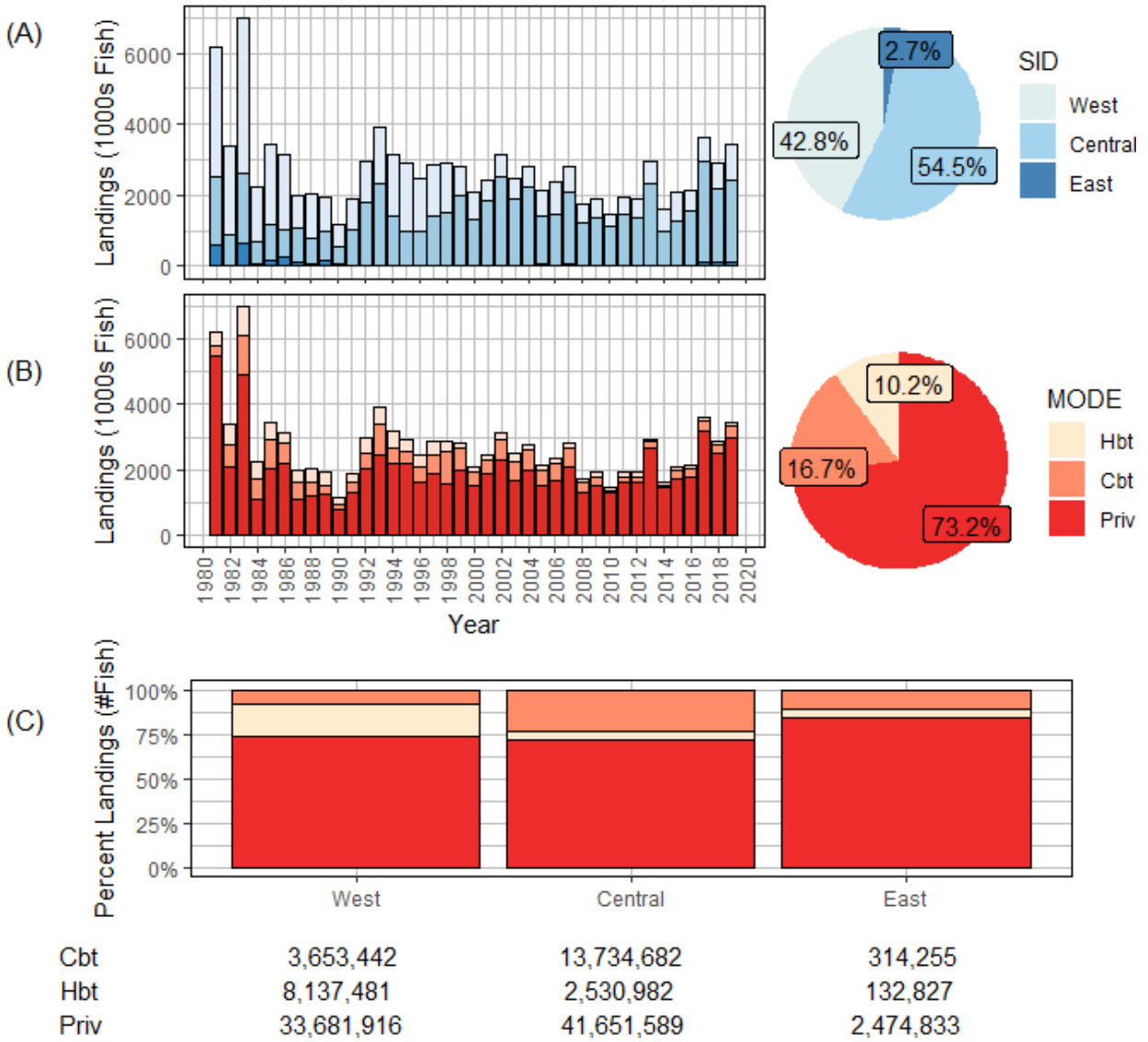


Ratios by stock ID and mode



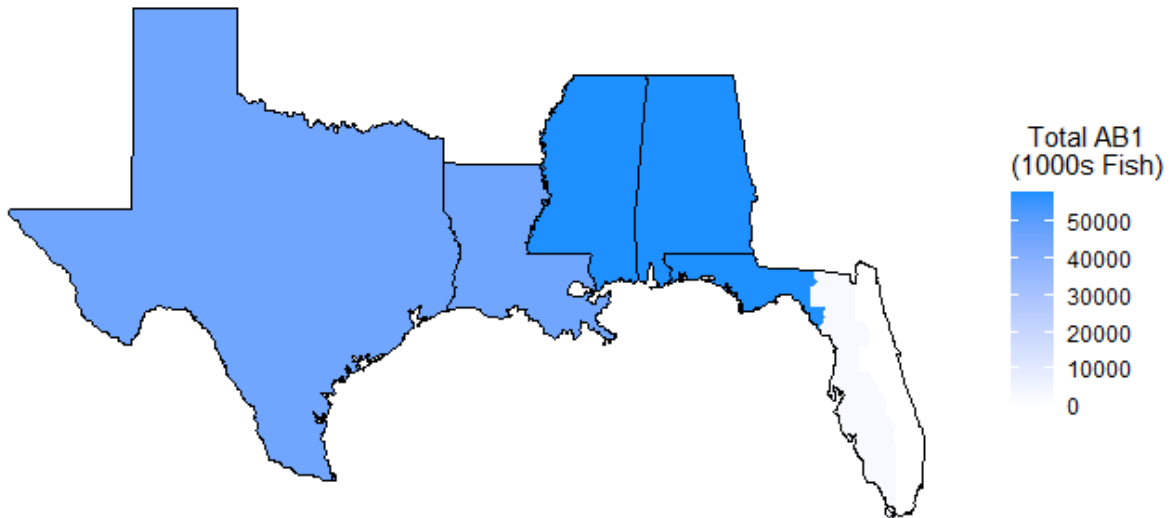
**Figure 4.13.2.** Adjusted ratios used in FWHAR method for estimating historical Red Snapper recreational landings from 1955 to 1980 by stock ID region, mode, and time period.

### Total Recreational Landings



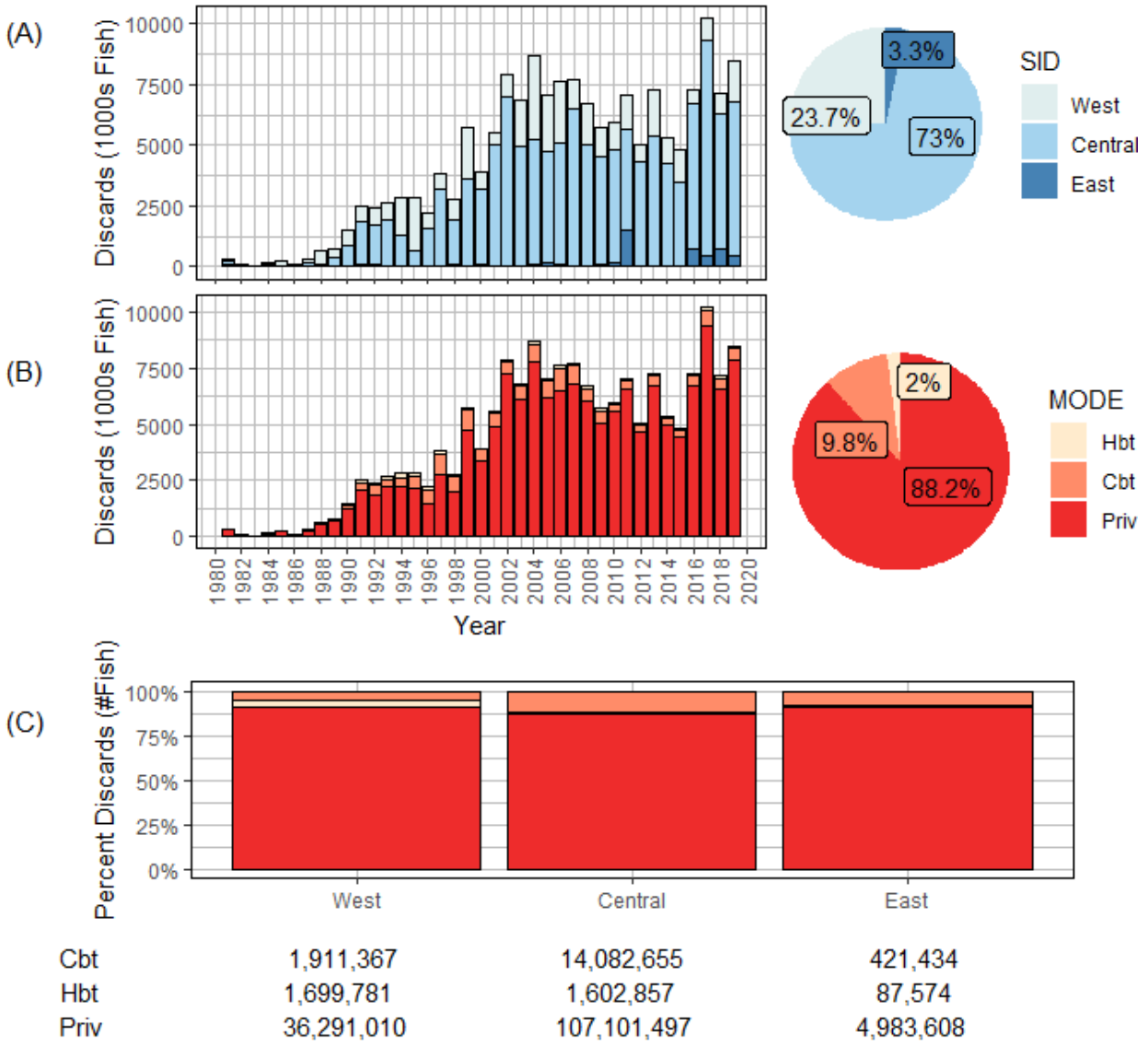
**Figure 4.13.3.** Total recreational landings (AB1) for Gulf of Mexico Red Snapper across all surveys (MRIP, SRHS, TPWD, and LA Creel). Landings are provided (A) by state and year (1981-2019) in thousands of fish, (B) by mode and year in thousands of fish, and (C) by mode and state in numbers of fish (as a percentage). The combined private-shore mode in the LA Creel survey is allocated as private fishing. MRIP headboat estimates are used from 1981-1985 and SRHS from 1986+.

**Total Recreational Landings (1981-2019)  
Gulf of Mexico Red Snapper**



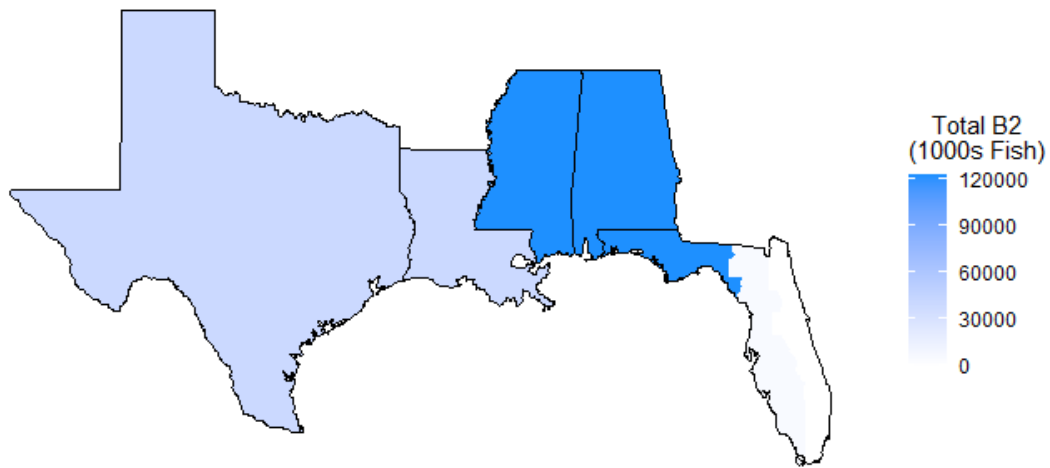
**Figure 4.13.4.** Distribution of total recreational landings (AB1), in thousands of fish, for Red Snapper across the Gulf of Mexico. Estimates are combined across all surveys (MRIP, SRHS, TPWD, and LA Creel) and years (1981-2019).

### Total Recreational Discards

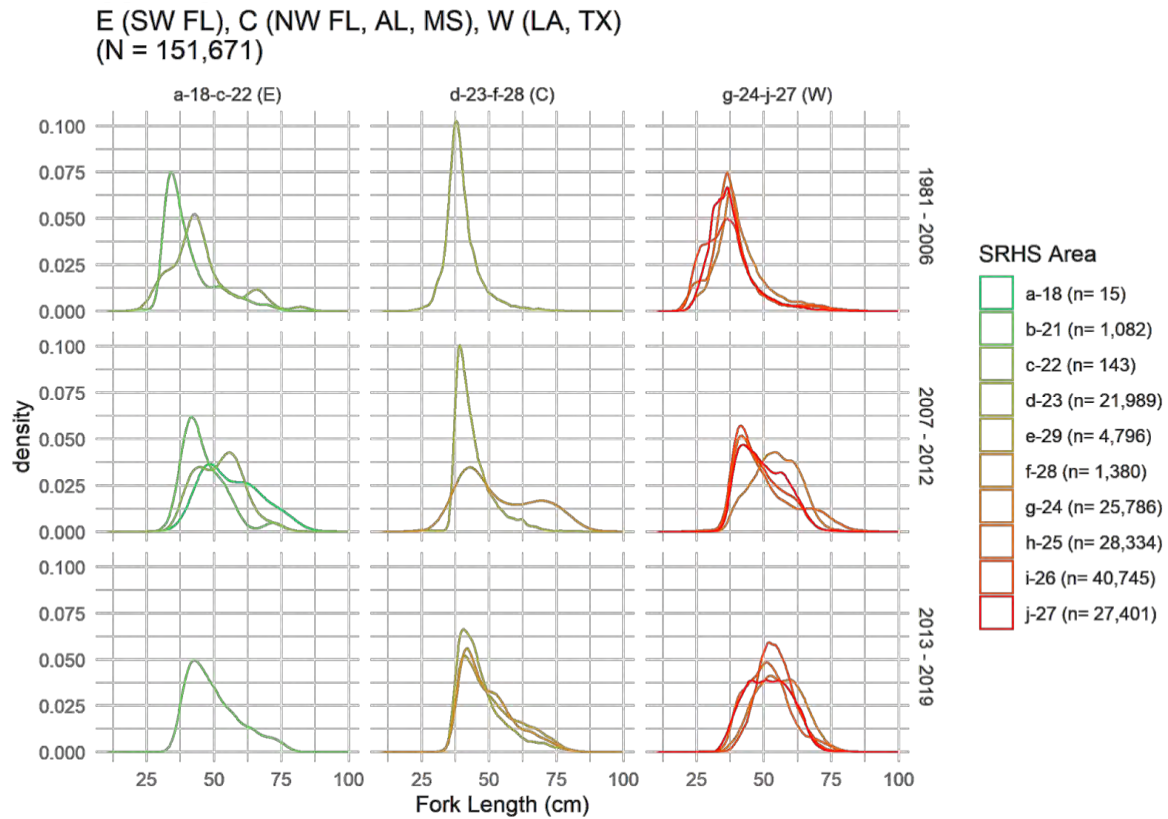


**Figure 4.13.5.** Total recreational discards (B2) for Gulf of Mexico Red Snapper across all surveys (MRIP, SRHS, TPWD, and LA Creel). Discards are provided (A) by state and year (1981-2019) in thousands of fish, (B) by mode and year in thousands of fish, and (C) by mode and state in numbers of fish (as a percentage). The combined private-shore mode in the LA Creel survey is allocated as private fishing. MRIP headboat estimates are used from 1981-1985 and SRHS from 1986+.

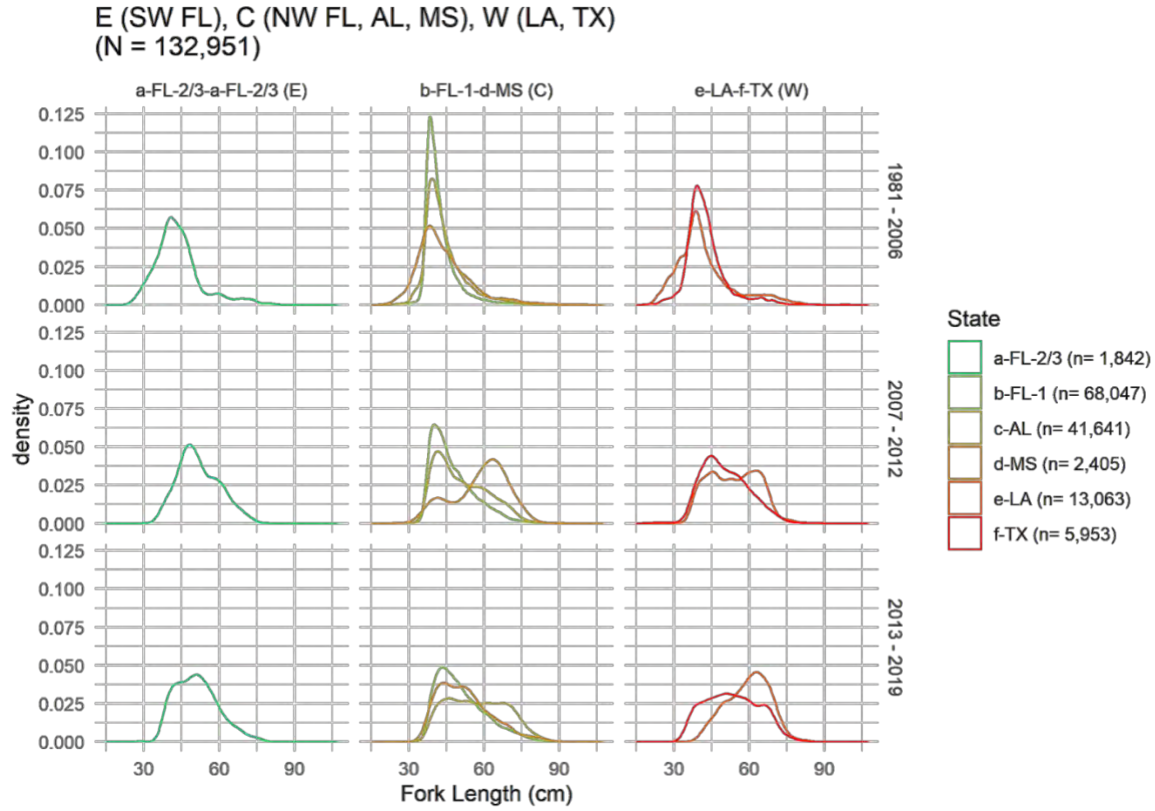
**Total Recreational Discards (1981-2019)  
Gulf of Mexico Red Snapper**



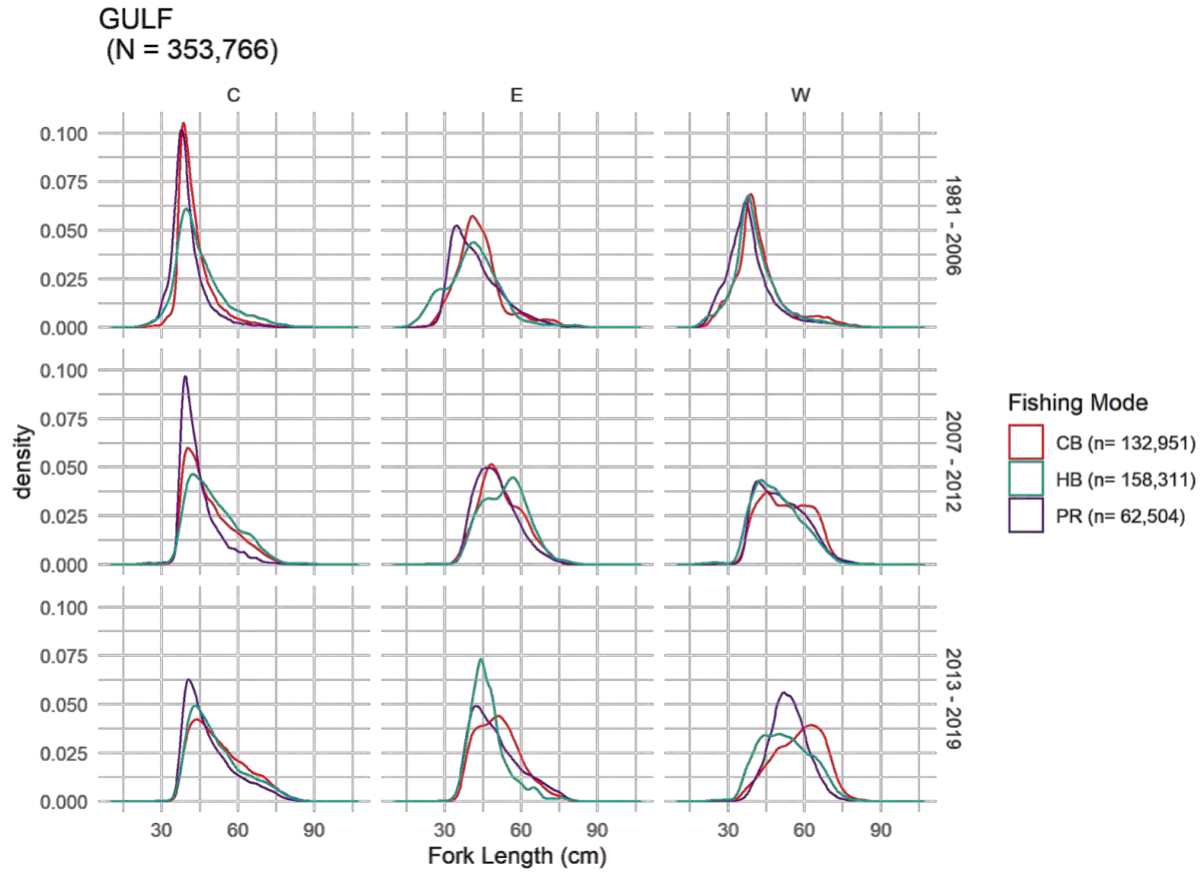
**Figure 4.13.6.** Distribution of total recreational discards (B2), in thousands of fish, for Red Snapper across the Gulf of Mexico. Estimates are combined across all surveys (MRIP, SRHS, TPWD, and LA Creel) and years (1981-2019).



**Figure 4.13.7.** Red snapper headboat length compositions at the finest spatial resolution by SRHS area where color gradients are shown from east (green) to west (red) and paneled by stock (columns) and time periods (rows).

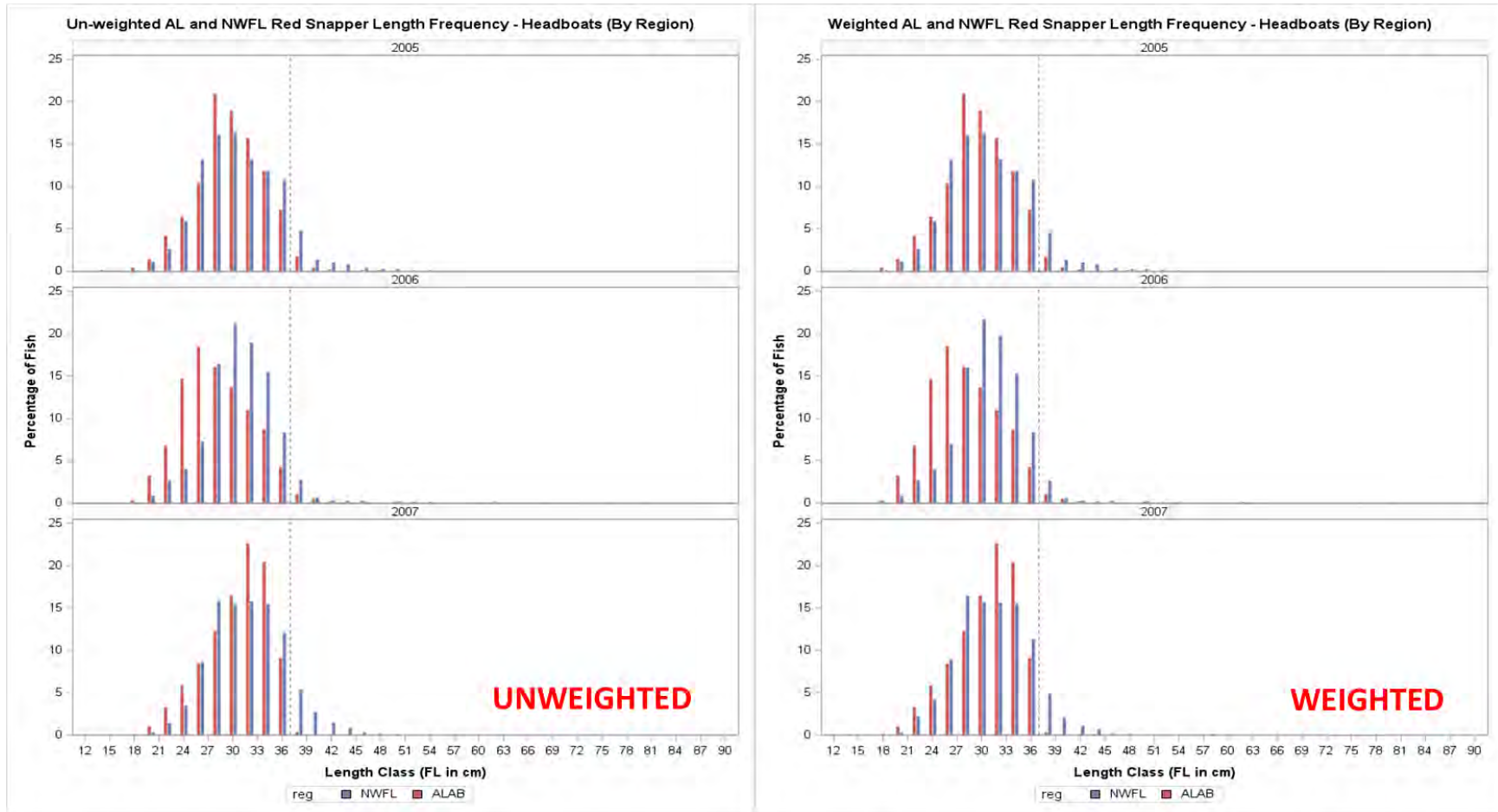


**Figure 4.13.8.** Red snapper charter boat length compositions at the finest spatial resolution by MRIP sampling domains where color gradients are shown from east (green) to west (red) and paneled by stock (columns) and time periods (rows).

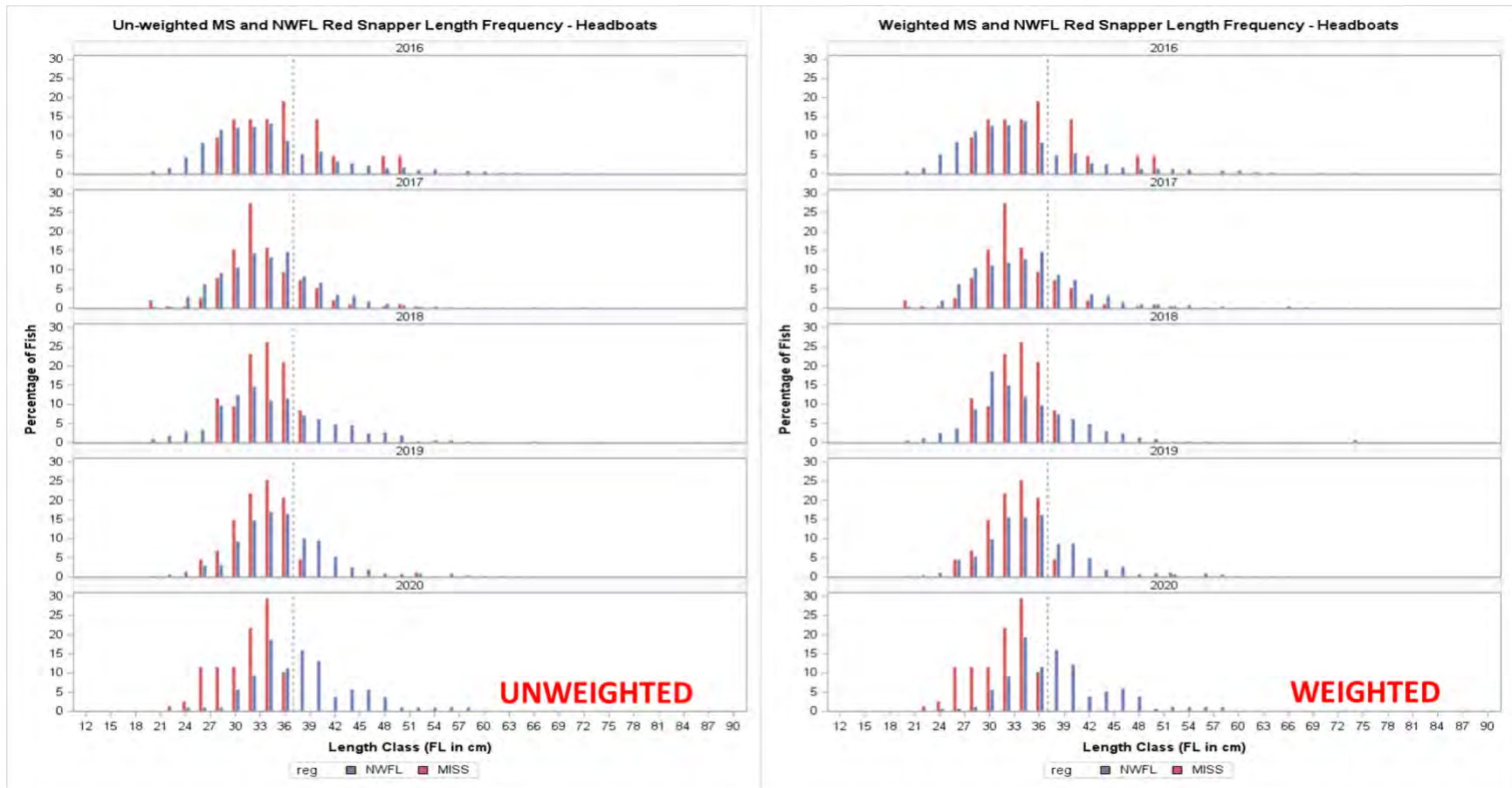


**Figure 4.13.9.** Red snapper charter boat, headboat, and private length compositions paneled by stock (columns) and time periods (rows).

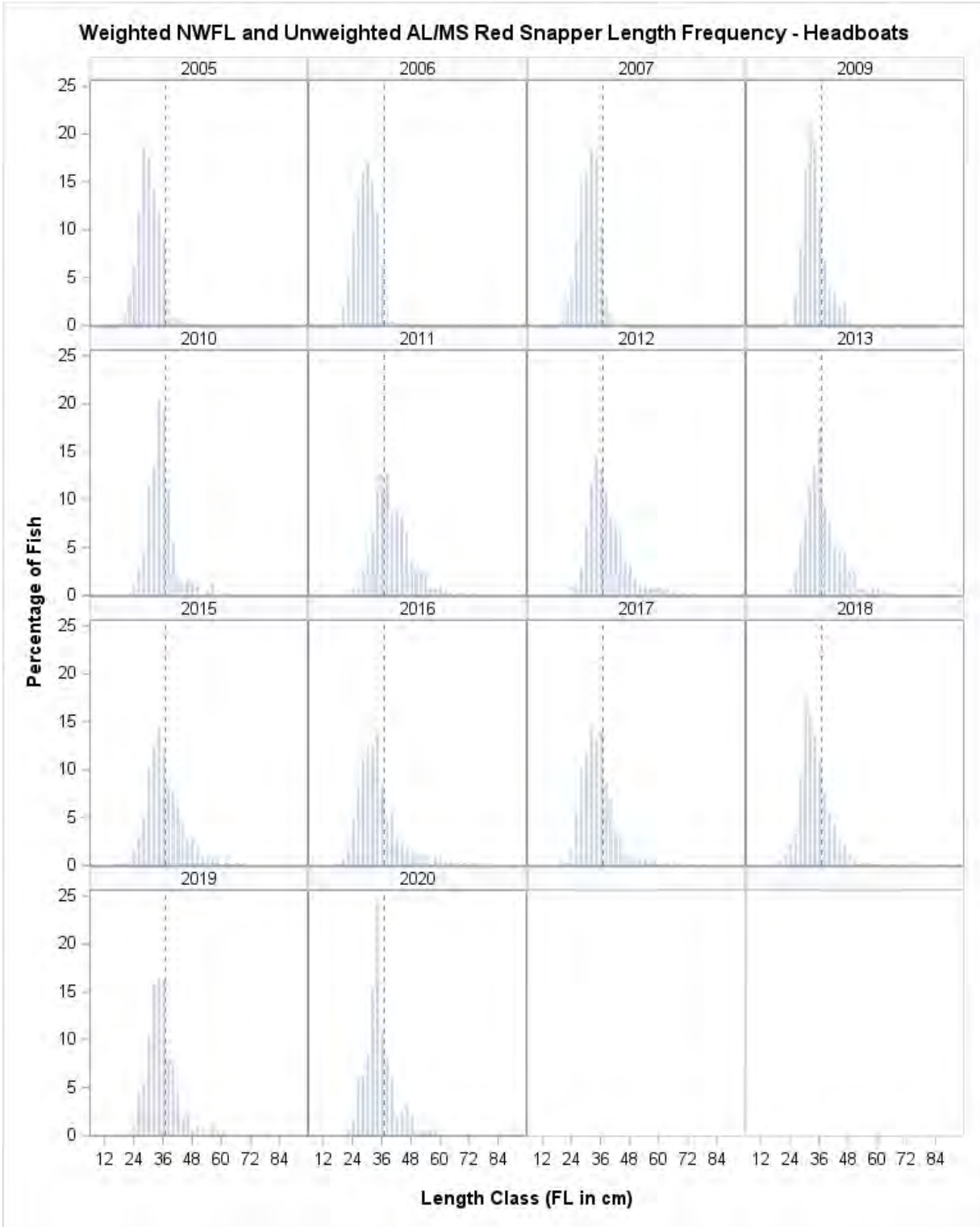




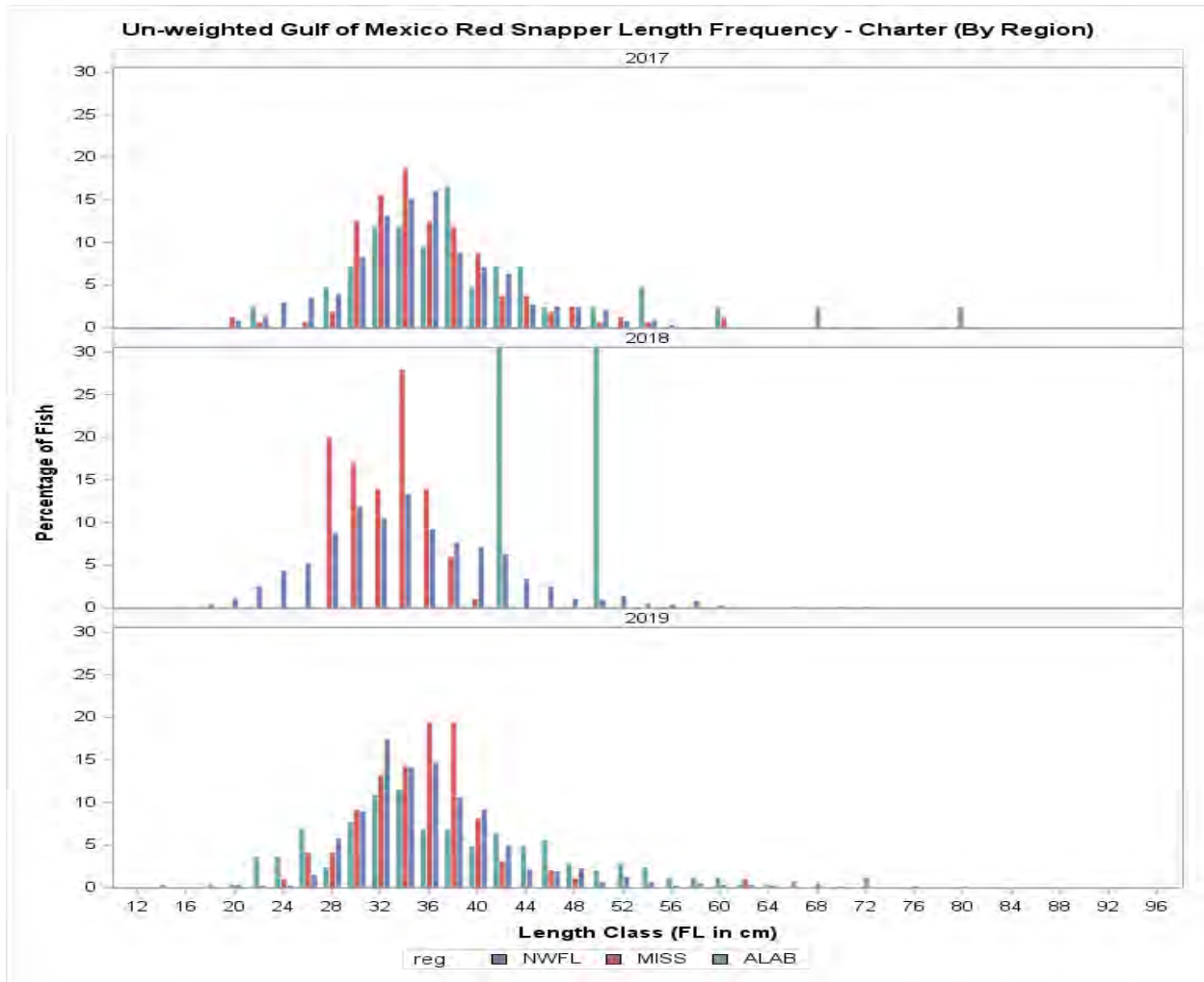
**Figure 4.13.10.** Comparison of Alabama and northwest Florida headboat discard length composition data from 2005-2007. The left pane corresponds with unweighted data, and right pane shows compares nominal Alabama and weighted northwest Florida data



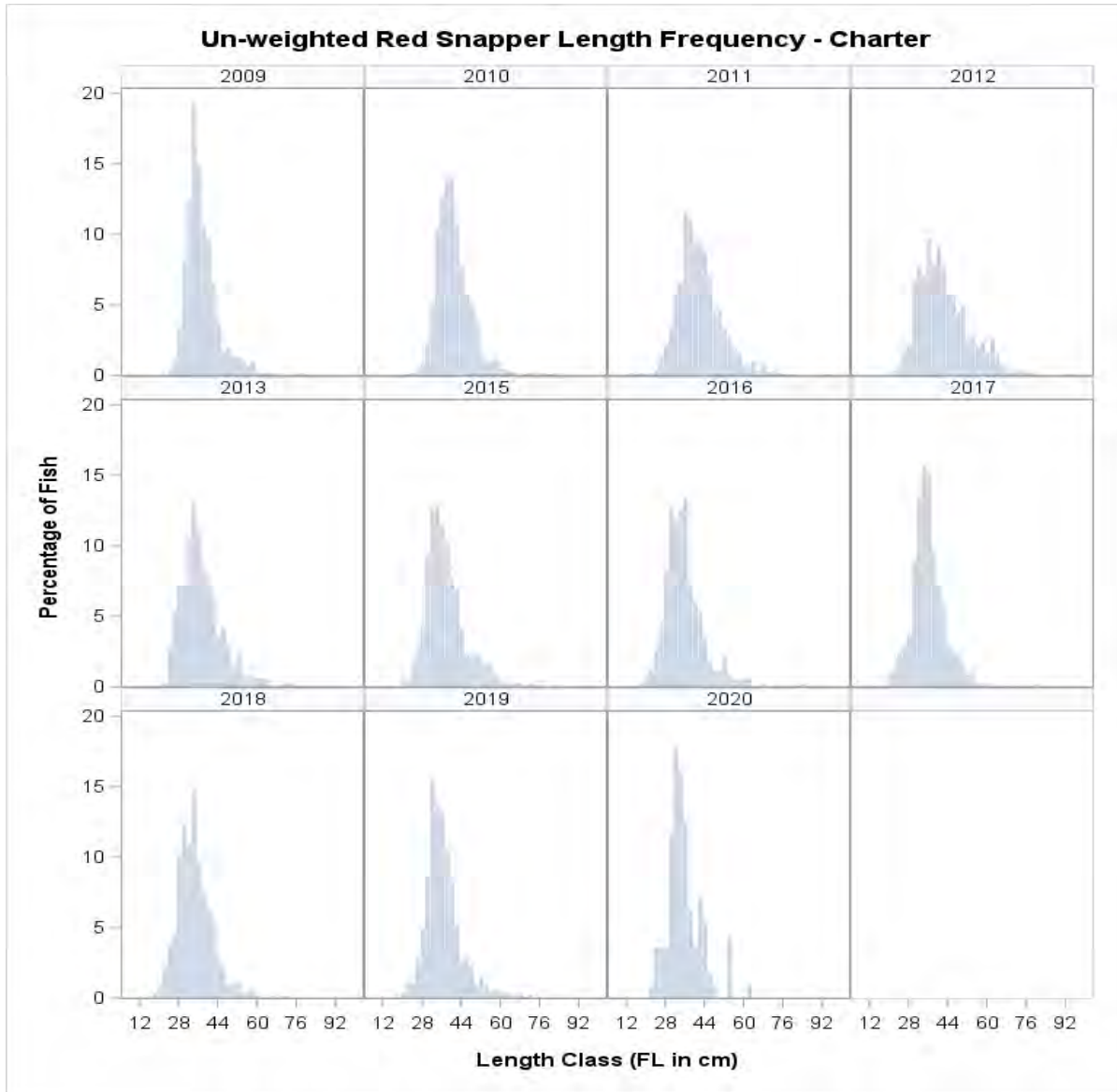
**Figure 4.13.11.** Comparison of Mississippi and northwest Florida headboat discard length composition data from 2016-2020. The left pane corresponds with unweighted data, and the right pane shows compares nominal Mississippi and weighted northwest Florida data.



**Figure 4.13.12.** Combined discard length composition data from 2005 to 2020, for the central stock assessment region. Northwest Florida data is weighted to correct for under/over sampling. Data from Mississippi and Alabama are unweighted.

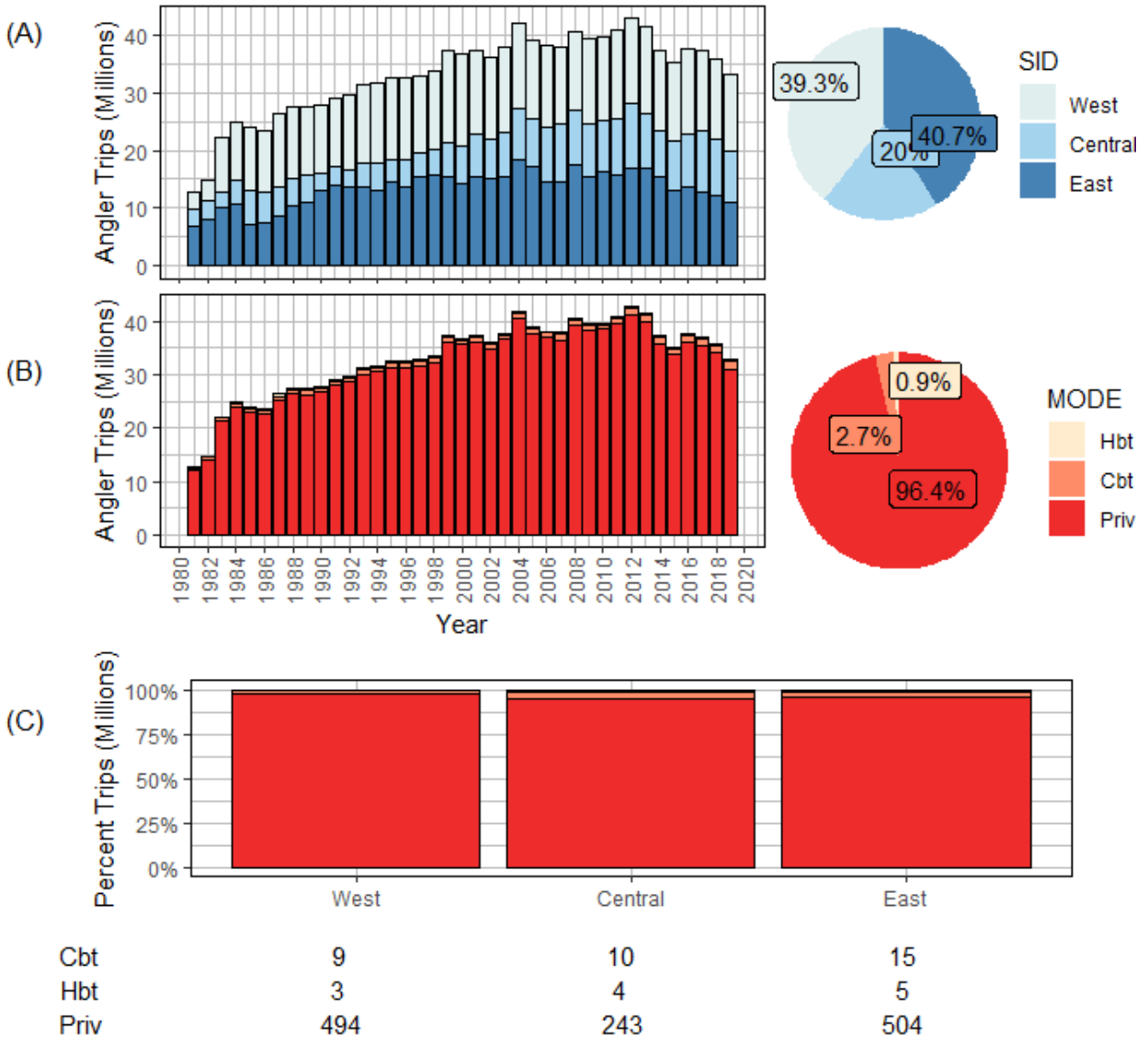


**Figure 4.13.13.** Comparison of unweighted charter discard length composition data from 2017 to 2019, the years where charter sampling overlaps between Mississippi, Alabama, and northwest Florida (the central stock assessment region).



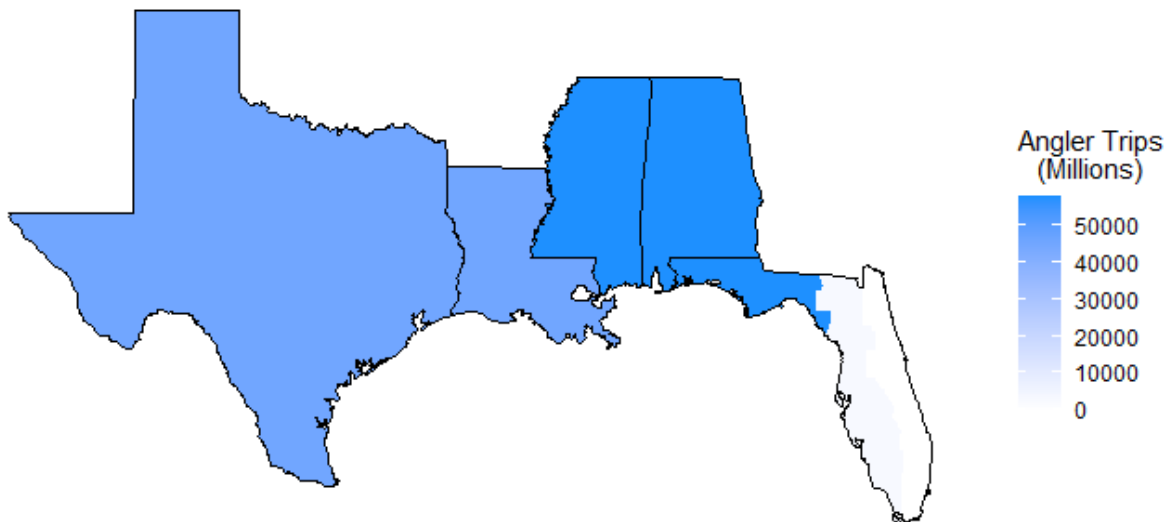
**Figure 4.13.14.** Combined charter discard length composition data from 2009 to 2020, for the central stock assessment region. All data is unweighted.

### Total Recreational Effort



**Figure 4.13.15.** Total recreational fishing effort for Gulf of Mexico anglers in millions of angler trips (MRIP, SRHS, TPWD, and LA Creel). Effort is provided (A) by state and year (1981-2019), (B) by mode and year, and (C) by mode and state (as a percentage). The combined private-shore mode in the LA Creel survey is allocated as private fishing. MRIP headboat estimates are used from 1981-1985 and SRHS from 1986+.

### Total Recreational Fishing Effort (1981-2019) Gulf of Mexico Anglers



**Figure 4.13.16.** Distribution of total recreational fishing effort by Gulf of Mexico anglers. Estimates are combined across all surveys (MRIP, SRHS, TPWD, and LA Creel) and years (1981-2019).

## 5 INDICES OF POPULATION ABUNDANCE

### 5.1 OVERVIEW

The Index Working Group (IWG) reviewed indices and accompanying analyses from 28 fishery-independent and 12 fishery-dependent datasets that represented regional relative abundance trends in the west, central, or east Gulf of Mexico (GOM) as defined by the SEDAR 74 Stock ID Workshop (SEDAR 74 Stock ID 2021). Section 5.2 lists all the working papers, which contain the full descriptions of the datasets, analytical methods and model diagnostics, reviewed by the IWG. The IWG reviewed and evaluated indices independently for each of the three regions in the GOM following the criteria listed in Section 5.3. Relative spatial coverage of “Suitable” and “Suitable and Recommended” indices are included in Figure 5.10.1 and 5.10.2, respectively. Rationalizations for the recommendation or exclusion of an index are given in the ‘Comments on Adequacy for Assessment’ in Sections 5.4 (fishery-independent) and 5.5 (fishery-dependent).

In the west GOM, seven fishery-independent and one fishery-dependent indices of abundance are recommended for use in the assessment by the IWG, while two fishery-independent and three fishery-dependent indices were not recommended. Sampling effort, relative abundance and



coefficient of variation on the mean (CV, standard error/mean) for recommended indices in the west region are show in Table 5.9.1, and overall trends in Figure 5.10.3.

<b>Recommended</b>	<b>Not Recommended</b>
SEFSC Bottom Longline	Fall Groundfish (1972-1986)
SEAMAP Summer Groundfish Old (1982-2008)	SEAMAP Vertical Line
SEAMAP Summer Groundfish New (2009-2019)	Recreational (Charter and Private)
SEAMAP Fall Groundfish Old (1988-2007)	Commercial VL Logbook (Pre IFQ)
SEAMAP Fall Groundfish New (2008-2019)	Commercial VL Observer (Post IFQ)
SEAMAP Fall Plankton	
SEAMAP Reef Fish Video	
Southeast Region Headboat Survey	

In the central GOM, five fishery-independent and one fishery-dependent indices of abundance are recommended for use in the assessment by the IWG, while seven fishery-independent and three fishery-dependent indices were not recommended. Sampling effort, relative abundance and CV for the recommended indices in the central region are shown in Table 5.9.2, and overall trends in Figure 5.10.4.

<b>Recommended</b>	<b>Not Recommended</b>
SEFSC Bottom Longline	Combined Bottom Longline (SEFSC / DISL)
SEAMAP Summer Groundfish New (2009-2019)	DISL Bottom Longline
SEAMAP Fall Groundfish New (2008-2019)	Fall Groundfish (1972-1986)
SEAMAP Fall Plankton	SEAMAP Summer Groundfish Old (1982-2008)
Combined Reef Fish Video	SEAMAP Fall Groundfish Old (1988-2007)
Southeast Region Headboat Survey	FWRI Artificial Reef Video
	SEAMAP Vertical Line
	Recreational (Charter and Private)
	Commercial VL Logbook (Pre IFQ)
	Commercial VL Observer (Post IFQ)

In the east GOM, four fishery-independent and two fishery-dependent indices of abundance are recommended for use in the assessment by the IWG, while three fishery-independent and two fishery-dependent indices were not recommended. Sampling effort, relative abundance and CV for recommended indices in the east region are shown in Table 5.9.3, and overall trends in Figure 5.10.5.



Recommended	Not Recommended
SEFSC Bottom Longline	SEAMAP Fall Plankton
SEAMAP Summer Groundfish New (2009-2019)	FWRI Artificial Reef Video
SEAMAP Fall Groundfish New (2008-2019)	SEAMAP Vertical Line
Combined Reef Fish Video	Southeast Region Headboat Survey
Commercial VL Logbook (Pre IFQ)	Recreational (Charter and Private)
Commercial VL Observer (Post IFQ)	

### 5.1.1 Terms of reference

The IWG was tasked with completing objectives associated with the following Terms of Reference (note that the numbering follows to the original Terms of Reference):

3. Provide measures of population abundance that are appropriate for stock assessment.
  - Consider all available and relevant fishery-dependent and -independent data sources
  - Document all programs evaluated; address program objectives, methods, coverage, sampling intensity, and other relevant characteristics.
  - Provide maps of fishery and independent survey coverage.
  - Develop fishery and survey CPUE indices by appropriate strata (e.g., age, size, area, and fishery).
  - Provide appropriate measures of uncertainty for the abundance indices to be used in stock assessment models.
  - Document pros and cons of available indices regarding their ability to represent abundance.
  - Categorize the available indices into one of three tiers: Suitable and Recommended, Suitable and Not Recommended, or Not Suitable; provide each categorization.
  - For recommended indices, document any known or suspected temporal patterns in catchability not accounted for by standardization.
  
11. Develop an updated Connectivity Modeling Simulation recruitment index for recruitment forecasting.
  - Explore potential hypotheses to link the ecosystem and climatic events identified to population and fishery parameters.

### 5.1.2 Group membership

Members of the IWG included: Adam Pollack (co-workgroup lead), David Hanisko (co-workgroup lead), Matthew Campbell, Dave Chagaris, LaTreese Denson, Francesca Forrestal, Chris Gardner, Carissa Gervasi, Eric Gigli, John Mareska, Paul Mickle, James Nance, Craig

Newton, Will Patterson, Ryan Rindone, Katie Siegfried, Matthew Smith, Ted Switzer, and Kevin Thompson.

The following people also provided data products to the group but were not included in discussions/recommendations outside of their data product: Mark Albins, Crystal Hightower, Kevin McCarthy, Kate Overly, and Steven Smith.

## 5.2 REVIEW OF WORKING PAPERS

The IWG reviewed the following working papers:

- SEDAR74-DW-13 - Standardized Catch Rate Indices for Red Snapper (*Lutjanus campechanus*) during 1981-2019 by the U.S. Gulf of Mexico Charterboat and Private Boat Recreational Fishery
- SEDAR74-DW-17 - Standardized Catch Rate Indices for Red Snapper (*Lutjanus campechanus*) during 1993-2006 by the U.S. Gulf of Mexico Vertical Line Fishery
- SEDAR74-DW-21 - Using a Censored Regression Modeling Approach to Standardized Catch Per Unit Effort for Red Snapper (*Lutjanus campechanus*) during 1986-2019 from the Southeast Region Headboat Survey in the U.S. Gulf of Mexico
- SEDAR74-DW-23 - Indices of abundance for Red Snapper (*Lutjanus campechanus*) on natural reefs in the eastern Gulf of Mexico using combined data from three independent video surveys
- SEDAR74-DW-24 - Develop an updated Connectivity Modeling Simulation recruitment index for recruitment forecasting
- SEDAR74-DW-26 - Red Snapper Abundance Indices from Bottom Longline Surveys in the Northern Gulf of Mexico
- SEDAR74-DW-27 - Indices of abundance for Red Snapper (*Lutjanus campechanus*) on artificial reefs on the West Florida Shelf from stationary video surveys
- SEDAR74-DW-28 - SEAMAP Reef Fish Video Survey: Relative Indices of Abundance of Red Snapper
- SEDAR74-DW-30 - Red Snapper Abundance Indices from Groundfish Surveys in the Northern Gulf of Mexico
- SEDAR74-DW-31 - Red Snapper (*Lutjanus campechanus*) larval indices of relative abundance from SEAMAP Fall Plankton Surveys, 1986 to 2019
- SEDAR74-DW-38 - Estimation of vertical line commercial indices for Western, Central, and Eastern Gulf of Mexico red snapper using reef fish observer data

SEDAR74-DW-39 - SEAMAP Vertical Longline Survey (2012-2021): Indices of Abundance of Gulf of Mexico Red Snapper, *Lutjanus campechanus*

### 5.3 CONSENSUS RECOMMENDATIONS AND SURVEY EVALUATION

All indices presented to the IWG were evaluated based on the following criteria:

- Fishery Dependent or Independent
- Data Sources
- Temporal Range
- Spatial Range
- Survey Design (e.g. fixed sampling sites, stratified random etc.)
- Sampling Methodology (e.g. gear, vessels, effort etc.)
- Ages and/or sizes represented
- Analytical Methods Appropriate?

After the index was evaluated, it was deemed either Suitable or Not Suitable, following the guidance in the Terms of Reference (see section 5.1.1). Once all the indices were evaluated on their own merits and determined to be Suitable / Not Suitable, suitable indices then entered the second stage of review that determined whether they would be recommended for use in the assessment. Indices were then assigned one of the following categories.

- Suitable and Recommended: Based on the criteria listed above, the index met the minimum requirements for being considered for use in the assessment and was deemed to be a representative example of the population trends for a given area.
- Suitable and Not Recommended: Based on the criteria listed above, the index met the minimum requirements for being considered for use in the assessment and was deemed not to be a representative example of the population trends for a given area.
- Not Suitable (Not Recommended): Based on the criteria listed above, the index did not meet the minimum requirements for being considered for use in the assessment.

### 5.4 FISHERY-INDEPENDENT INDICES

#### 5.4.1 NOAA Fisheries SEFSC Bottom Longline Survey

The NOAA Fisheries Southeast Fisheries Science Center (SEFSC) Population and Ecosystem Monitoring (PEM) Division has conducted standardized bottom longline surveys in the Gulf of Mexico (GOM), Caribbean, and Western North Atlantic Ocean (Atlantic) since 1995. The objective of these surveys is to provide fisheries independent data for stock assessment purposes

for as many species as possible. The survey fishes a one nautical mile bottom longline, with 100 baited hooks for one hour.

#### 5.4.1.1 Methods of Estimation

**Working Paper Number:** SEDAR74-DW-26

**Data Type:** Fishery Independent

**Time Series:** 2001 – 2019

**Sampling Intensity:** Tables 5 (west), 7 (central) and 9 (east) in working paper.

**Size/Age Data:** Primarily age-2+ adult fish.

**Data Filtering Techniques:** Standard filtering protocols to remove problematic stations.

**Standardization:** Delta-lognormal

##### Submodel Variables

West:

Binomial: Year + Zone + Depth

Positive Observations: Year

Central:

Binomial: Year + Zone

Positive: Year

East:

Binomial: Year + Zone

Positive: Year + Zone

**Abundance Indices:** Tables 5 (west), 7 (central) and 9 (east) in working paper.

#### 5.4.1.2 Comments on Adequacy for Assessment

Indices from the SEFSC Bottom Longline Survey were presented for the west, central, and east regions. Overall, the IWG deemed all of the regional indices were suitable for further examination based on the spatial and temporal coverages, fishery independent, and the statistical design. In the east region, concerns were raised about the lack of positive occurrences over several years and single positive occurrences in other years. However, since this survey primarily indexes larger adults, it was suggested that the east index be recommended for the assessment to help show the presence of these larger adults as the stock recovers/expands. In addition, both the indices for the west and central regions were deemed suitable. After reviewing all of the indices for all three regions, the indices were deemed “Suitable and Recommended”.

#### 5.4.2 NOAA Fisheries SEFSC Fall Groundfish Survey

The NOAA Fisheries SEFSC Fall Groundfish Survey (henceforth, Fall Groundfish Survey) was conducted from 1972 to 1984 and primarily covered an area within the north central Gulf of Mexico (GOM) between 88° W and 91°30' W, with some additional sampling to the east and west. The survey was conducted primarily during October and November with up to three 10-

minute tows at stations randomly selected from a block-grid system. Sampling occurred between 5 and 50 fathoms. During 1985 and 1986, the survey was moved under SEAMAP; however, the block-grid survey design was retained. Therefore, those years were retained for analysis with the Fall Groundfish Survey, as opposed to being included with the SEAMAP Fall Groundfish Survey (Old Design).

#### 5.4.2.1. Methods of Estimation

**Working Paper Number:** SEDAR74-DW-30

**Data Type:** Fishery Independent

**Time Series:** 1972-1986

**Sampling Intensity:** Tables 4 (west) and 10 (central) in working paper.

**Size/Age Data:** No length data available, but assumed to be similar to SEAMAP Fall Groundfish Survey lengths, primarily age-0 red snapper

**Data Filtering Techniques:** Standard filtering protocols to remove problematic stations.

**Standardization:** Delta-lognormal

##### Submodel Variables

West:

Binomial: Year + Depth

Positive Observations: Year + Depth

Central:

Binomial: Year + Depth + Time of Day

Positive: Year + Depth + Time of Day

**Abundance Indices:** Tables 4 (west) and 10 (central) in working paper.

#### 5.4.2.2. Comments on Adequacy for Assessment

Upon review of the Fall Groundfish Survey and the SEAMAP Groundfish Survey, the IWG agreed that it was appropriate to split the time series because of the differences in survey design and survey area. In addition, there were no issues with the survey design, nor the temporal coverage. However, the IWG did have concerns about the limited coverage in both the west and central regions and did not feel that the area covered by the Fall Groundfish Survey would be representative of the entire west and central regions. Based on those concerns, the Fall Groundfish Survey was deemed “Suitable and Not Recommended”.

#### 5.4.3 SEAMAP Summer Groundfish Survey (Old Design)

While the NMFS Fall Groundfish Survey was being conducted in the fall, a summer (primarily sampling during June and July) groundfish survey was added in 1982 under the Southeast Area Monitoring and Assessment Program (SEAMAP) to address the effectiveness of the Texas Closure. SEAMAP is a collaborative effort between federal, state and university programs, designed to collect, manage and distribute fishery independent data throughout the region. Sampling during the summer survey was conducted during the night using a stratified random

design with strata defined by area and depth zone (see presentation for strata definition). This survey covered an area between Brownville, TX and Mobile Bay, AL. It should be noted that shrimp statistical zone (SSZ) 10 was dropped from the survey universe in 1989 because of the increased number of hangs in the area as Alabama expanded their artificial reef permit area. In addition, the years 1982 and 1983 were dropped from the analysis in the west region due to poor spatial coverage.

Beginning in 1987, the SEAMAP summer and fall groundfish surveys adopted a unified sample design. Strata were still defined by area and depth zone, but with an additional stratum based on time of day (day and night) incorporated into the design. Towing time was variable during the survey, ranging from 10 (min) to 55 (max) minutes, and was dependent on the time required to completely tow through a depth zone. If the depth zone could not be covered in 55 minutes, multiple tows were made at the station. The survey gear consists of a 12.8-m (42 ft) semi-balloon shrimp trawl with a 12.8-m headrope and does not contain a turtle excluder device (TED) or any bycatch reduction devices (BRD).

#### 5.4.3.1. Methods of Estimation

**Working Paper Number:** SEDAR74-DW-30

**Data Type:** Fishery Independent

**Time Series:** 1982-2008

**Sampling Intensity:** Tables 18 (west) and 22 (central) in working paper.

**Size/Age Data:** Primarily age-1 red snapper

**Data Filtering Techniques:** Standard filtering protocols to remove problematic stations.

**Standardization:** Delta-lognormal

##### Submodel Variables

West:

Binomial: Year + Depth Zone + Paired SSZ + Time of Day

Positive Observations: Year + Depth Zone

Central:

Binomial: Year + Depth Zone

Positive: Year + Time of Day

**Abundance Indices:** Tables 18 (west) and 22 (central) in working paper.

#### 5.4.3.2. Comments on Adequacy for Assessment

After a review of the changes in survey methodology between the SEAMAP Summer Groundfish Survey (Old Design) and the SEAMAP Summer Groundfish Survey (New Design), the IWG agreed that the time series should be split when the survey design change was implemented. For the SEAMAP Summer Groundfish Survey (Old Design), the survey design was deemed acceptable as it was a long time series and the only time series that surveys subadult (primarily age-1) red snapper. The survey coverage across the West Region was robust, with the

entire area covered in most years. Therefore, the IWG deemed the index for the west region “Suitable and Recommended”. However, spatial coverage in the central region was not as robust, with only the areas off Mississippi and Alabama sampled. Therefore, the IWG deemed the index for the central region “Suitable and Not Recommended”.

#### 5.4.4 SEAMAP Summer Groundfish Survey (New Design)

Major changes in the SEAMAP sample design occurred between the 2008 summer and fall surveys. The time of day stratification was dropped, tow time was standardized to 30 minutes, and sampling effort allocated proportionally by the spatial area represented by each shrimp statistical zone and depth zone combination. Minor changes to depth zones were made during subsequent years with the current design utilizing two depth zones, which have been consistent since 2013. While the change in sample design occurred in 2008, it is important to note that the state partners did not adopt the new sample design until 2010.

In 2008, SEAMAP received supplemental funding that provided the opportunity to conduct experimental bottom trawl surveys on the West Florida Shelf. Based on the success of the experimental trawl surveys by the state of Florida, the surveys were fully expanded in 2010 to include the area from Mobile Bay, AL to Key West, FL. The survey gear consists of a 12.8-m (42 ft) semi-balloon shrimp trawl with a 12.8-m headrope and does not contain a turtle excluder device (TED) or any bycatch reduction devices (BRD).

##### 5.4.4.1. Methods of Estimation

**Working Paper Number:** SEDAR74-DW-30

**Data Type:** Fishery Independent

**Time Series:** 2009-2019

**Sampling Intensity:** Tables 20 (west), 24 (central) and 26 (east) in working paper.

**Size/Age Data:** Primarily age-1 red snapper

**Data Filtering Techniques:** Standard filtering protocols to remove problematic stations.

**Standardization:** Delta-lognormal

##### **Submodel Variables**

West:

Binomial: Year + Depth + SSZ

Positive Observations: Year + Depth + SSZ

Central:

Binomial: Year + SSZ

Positive: Year + SSZ

East:

Binomial: Year + SSZ

Positive: Year + Time of Day

**Abundance Indices:** Tables 20 (west), 24 (central) and 26 (east) in working paper.

#### 5.4.4.2. Comments on Adequacy for Assessment

As noted in Section 5.3.3.2, the SEAMAP time series was split when the survey design was changed in 2008. For the SEAMAP Summer Groundfish Survey (New Design), the survey design was deemed acceptable as it was a long time series and was the only time series that surveys subadult (primarily age-1) red snapper. The survey coverage across the all the regions were robust, with the entire area being covered in most year. Therefore, the IWG deemed the indices for all of the regions “Suitable and Recommended”.

#### 5.4.5 SEAMAP Fall Groundfish Survey (Old Design)

Starting in 1985, the NMFS Shrimp/Bottomfish Trawl Survey was brought under the SEAMAP umbrella. The survey retained the block-grid survey design, but expanded the depth coverage out to 100 fathoms. Sampling intensity was reduced to a single 15-minute tow per grid to accommodate a westward expansion to include the Texas shelf. Sampling occurred during day and night. Even though this is officially a SEAMAP survey, it is typically treated as part of the Shrimp/Bottomfish Trawl Survey due to the use of the block-grid design. For a full description of all the surveys, additional background and time series rationale see Nichols 2004.

Beginning in 1987, the SEAMAP summer and fall groundfish surveys adopted a unified sample design. Strata were still defined by area and depth zone, but with an additional stratum based on time of day (day and night) incorporated into the design. Towing time was variable during the survey, ranging from 10 (min) to 55 (max) minutes, and was dependent on the time required to complete tow through a depth zone. If the depth zone could not be covered in 55 minutes, multiple tows were made at the station. The survey gear consists of a 12.8-m (42 ft) semi-balloon shrimp trawl with a 12.8-m headrope and does not contain a turtle excluder device (TED) or any bycatch reduction devices (BRD).

#### 5.4.5.1. Methods of Estimation

**Working Paper Number:** SEDAR74-DW-30

**Data Type:** Fishery Independent

**Time Series:** 1987-2007

**Sampling Intensity:** Tables 6 (west) and 12 (central) in working paper.

**Size/Age Data:** Primarily age-0 red snapper

**Data Filtering Techniques:** Standard filtering protocols to remove problematic stations.

**Standardization:** Delta-lognormal

##### Submodel Variables

West:

Binomial: Year + Depth Zone + Paired SSZ + Time of Day



Positive Observations: Year + Depth Zone + Paired SSZ + Time of Day

Central:

Binomial: Year + Depth Zone + Time of Day

Positive: Year + Depth Zone + Time of Day

**Abundance Indices:** Tables 6 (west) and 12 (central) in working paper.

#### 5.4.5.2. Comments on Adequacy for Assessment

As discussed in Section 5.3.3.2, the SEAMAP Fall Groundfish Survey was split between the old and new survey designs was deemed acceptable. For the SEAMAP Fall Groundfish Survey (Old Design), the survey design was deemed acceptable as it was a long time series and was the only time series that surveys subadult (primarily age-0) red snapper. The survey coverage across the west region was robust, with the entire area being covered in most years. Therefore, the IWG deemed the index for the west region “Suitable and Recommended”. However, spatial coverage in the central region was not as robust, with only the areas off Mississippi and Alabama sampled. Therefore, since the IWG did not think this area was representative of the entire central region, the index for the central region was deemed “Suitable and Not Recommended”.

#### 5.4.6 SEAMAP Fall Groundfish Survey (New Design)

Major changes in the sample design occurred between the 2008 summer and fall surveys. The time of day stratification was dropped, tow time was standardized to 30 minutes and sampling effort allocated proportionally by the spatial area represented by each shrimp statistical zone and depth zone combination. Minor changes to depth zones were made during subsequent years and the current design utilizes two depth zones, which have been consistent since 2013. While the change in sample design occurred in 2008, it is important to note that the state partners did not adopt the new sample design until 2010.

In 2008, SEAMAP received supplemental funding that provided the opportunity to conduct experimental bottom trawl surveys on the West Florida Shelf. Based on the success of the experimental trawl surveys by the state of Florida, the surveys were expanded in 2010 to include the area from Mobile Bay, AL to Key West, FL.

#### 5.4.6.1. Methods of Estimation

**Working Paper Number:** SEDAR74-DW-30

**Data Type:** Fishery Independent

**Time Series:** 2008-2019

**Sampling Intensity:** Tables 8 (west), 14 (central) and 16 (east) in working paper.

**Size/Age Data:** Primarily age-0 red snapper

**Data Filtering Techniques:** Standard filtering protocols to remove problematic stations.

**Standardization:** Delta-lognormal

**Submodel Variables**

West:

Binomial: Year + SSZ

Positive Observations: Year + Depth + SSZ

Central:

Binomial: Year + Depth + SSZ

Positive: Year + Depth + SSZ

East:

Binomial: Year + Depth + SSZ

Positive: Year + SSZ

**Abundance Indices:** Tables 8 (west), 14 (central) and 16 (east) in working paper.

#### 5.4.6.2. Comments on Adequacy for Assessment

As noted in Section 5.3.3.2, the SEAMAP time series was split when the survey design was changed in 2008. For the SEAMAP Fall Groundfish Survey (New Design), the survey design was deemed acceptable because it provided a long time series and was the only time series that surveys subadult (primarily age-0) red snapper. The survey coverage across the all the regions was robust, with the entire area covered in most years. Therefore, the IWG deemed the indices for all of the regions “Suitable and Recommended”.

#### 5.4.7 SEAMAP Reef Fish Video Survey

The primary objective of the annual Southeast Area Monitoring and Assessment Program (SEAMAP) reef fish video survey is to provide an index of the relative abundances of fish species associated with topographic features (e.g., reefs, banks, and ledges) located on the continental shelf of the Gulf of Mexico (GOM) from Brownsville, TX to the Dry Tortugas, FL. Secondary objectives include quantification of habitat types sampled (video, multi-beam and side-scan), and collection of environmental data throughout the survey. Because the survey is conducted on topographic features the species assemblages targeted are typically classified as reef fish (e.g. red snapper, *Lutjanus campechanus*), but occasionally fish more commonly associated with pelagic environments are observed (e.g. Amberjack, *Seriola dumerili*). The survey has been executed from 1992-1997, 2001-2002, and 2004-present and historically takes place from April - May, however in limited years the survey was conducted through the end of August. The 2001 survey was abbreviated due to ship scheduling, during which, the only sites that were completed were located in the western Gulf of Mexico. Data was not collected in 2020 due to the COVID outbreak. Types of data collected on the survey include diversity, abundance (MinCount, i.e. MaxN), fish length, habitat type, habitat coverage, bottom topography and water quality. The size of fish sampled with the video gear is species specific; however, Red Snapper sampled over the history of the survey had fork lengths ranging from 116 – 1061 mm, and mean annual fork lengths ranging from 355 – 558 mm (Table 5, Figure 30). Age and reproductive data

cannot be collected with the camera gear, but beginning with the 2012 survey, a vertical line component was coupled with the video drops to collect hard parts, fin clips, and gonads and was included in the life history information provided by the NMFS Panama City Laboratory.

#### 5.4.7.1. Methods of Estimation

**Working Paper Number:** SEDAR74-DW-28

**Data Type:** Fishery Independent

**Time Series:** 1993-2019

**Sampling Intensity:** Average number of stations / 128.9 (sd = 59.5).

**Size/Age Data:** Table 5 and Figure 30 in working paper.

**Data Filtering Techniques:** Manual filtration of low sample years (1998-2000, and 2003).

Manual reduction of the dataset to the west Gulf only as prescribed in the red snapper stock ID process.

**Standardization:** Negative-binomial

**Model Variables** [*year, habitat complexity, depth*]

**Annual Abundance Indices:** Table 4 (west) in working paper.

#### 5.4.7.2. Comments on Adequacy for Assessment

The index was recommended for use in the assessment model given the history of its continued use in benchmark and update assessments. In addition to the bottom longline survey, the SEAMAP RFV survey index is considered one of the more critical indices to include in the assessment. The survey frequently observes red snapper on the deployments given that the sampling design targets reef. Some discussion was raised concerning the large increase in the index between 2017 and 2018. The data appear to be real in that the high point coincides with a high number of positive sites in the west Gulf (coastal Texas in particular) that also showed high abundance. The point also corresponds with other indices showing similar increases in that time frame and discussion led to the conclusion that by definition sampling is inherently variable and this is only one representation of the status of the stock. The survey shows reasonable precision with CVs ranging from 15-25%. Importantly, this index is the only fisheries independent survey data that is collected on sensitive reef environments where trawl and longline gears cannot be deployed.

#### 5.4.8 Combined Video Survey

Historically, three different stationary video surveys were conducted to assess trends in reef fish relative abundance in the northern Gulf of Mexico (GOM). The NMFS SEAMAP reef fish video survey (SFRV), carried out by NMFS Mississippi Laboratory, has the longest running time series (1993-1997, 2002, and 2004+), followed by the NMFS Panama City lab survey (PC; 2005+), with the most recent survey being the Florida Fish and Wildlife Research Institute video survey (FWRI, starting year 2010). Given the surveys use standardized deployment, camera field of view, and fish abundance methods to assess fish abundancies on reef or structured habitat,

combining indices across datasets allows for the largest possible sample sizes in model fitting and encompassing a greater proportion of the distribution of the stock. As such, we used a habitat-based approach to combine relative abundance data for generating annual trends for Red Snapper (*Lutjanus campechanus*) throughout the east GOM (eGOM) for the central and east regions as defined in the Stock ID process for this assessment.

#### 5.4.8.1. Methods of Estimation

**Working Paper Number:** SEDAR74-DW-23

**Data Type:** Fishery Independent

**Time Series:** 1993-2020 (central); 2010-2020 (east)

**Sampling Intensity:** Table 5 (central) and Table 6 (east) in working paper.

**Size/Age Data:** represents juvenile through adult biomass; see figures 11-13 in working paper.

**Data Filtering Techniques:** For all surveys, video reads were excluded if they were unreadable due to turbidity or deployment errors. For the SFRV survey, data included in this index are from 1993 and on, due to different counting methods in 1992. The entire spatial extent of the Panama City data was used from 2006 on with 2005 excluded because of an incomplete survey. For the FWRI data from prior to 2010 was excluded due to the earlier year's not including side-scan geofom as a variable which was determined to be potentially important as an explanatory variable in the analyses. Following discussions at the data workshop, the decision was made to truncate the overall time series for the south region due to very low catch rates in the SFRV survey initially and the small footprint of the PC survey in that region. Therefore, the east index was limited to 2010-2020.

**Standardization:** Relative abundance indices were generated using a stepwise approach. First, a habitat variable was created that included each of the separate survey individual variables that could be applied to all the data. This was done so final index models can account for changing sampling effort and habitat allocation through time rather than limiting the model to be predicted only by year and survey. We first determined the percentage of sites that occurred on good, fair, or poor (G, F, P) habitats for each survey and region independently. For this, we used a categorical regression tree approach (CART). These subsequent variables were then used a negative-binomial GLM along with year and survey to predict annual abundances for each region independently.

##### **Submodel Variables**

Central CART variables by survey:

SFRV: presence/absence of seawhips, presence/absence of shell, maximum relief, latitude, longitude

PC: depth, presence/absence of soft corals, maximum relief

FWRI: geofom, longitude, maximum relief, depth

East CART variables by survey:

SFRV: longitude, latitude, depth

PC: depth, presence/absence of soft corals, presence/absence of sponge, presence/absence of algae

FWRI: longitude, latitude, depth, habitat strata

**Annual Abundance Indices:** Table 5 (central) and Table 6 (east) in working paper.

#### 5.4.8.2. Comments on Adequacy for Assessment

This index was deemed both suitable and recommended for this assessment. This decision was due to the wide range of the stock being covered in terms of both spatial coverage and habitats sampled, the large sample sizes of video sets, and the large size range of this species being indexed. Following discussions within the IWG, initial analyses were re-run to exclude early years in the time series for the east given the low catches in the time series until the addition of the more inshore efforts by the FWRI survey began in 2010 and the final SFRV CART models and index values recommended and submitted reflect this.

#### 5.4.9 SEAMAP Fall Plankton Survey

The Southeast Area Monitoring and Assessment Program (SEAMAP) has supported the collection and analysis of ichthyoplankton samples from fishery-independent resource surveys in the Gulf of Mexico since 1982 with the goal of producing a long-term database on the early life stages of fishes. Red Snapper (*Lutjanus campechanus*) larvae captured in bongo net samples during the SEAMAP Fall Plankton Surveys were used to develop indices of relative abundance from 1986 to 2019. The indices represent trends in the adult spawning stock biomass.

##### 5.4.9.1. Methods of Estimation

**Working Paper Number:** SEDAR74-DW-31

**Data Type:** Fishery Independent

**Time Series:** 1986-2019

**Sampling Intensity:** See Table 4 (west), Addendum Table 1 (northeast/central) and Table 7 (east) in working paper.

**Size/Age Data:** Represents the adult spawning stock

**Data Filtering Techniques:** Occurrence and age corrected catch per unit area (CPUA) used in the indices were based on larvae greater than 3.75 mm and less than 9.75 mm in body length to account for the identification uncertainty of smaller snapper larvae and the effects of gear avoidance by larger rarely caught larvae. Year to year variability in spatial coverage from Fall Plankton Survey data was addressed by limiting observations to samples taken at SEAMAP stations that were sampled during at least (~66% ) of all years for which there was consistent spatial coverage respectively to the west, northeast/central and east Gulf of Mexico. Core data for the west index included all samples taken during at least 20 of the 30 years of available data, the core data for the updated northeast/central index included all samples taken during at least 22 of the 33 years of available data, and core data for the east index included all samples taken

during at least 18 of 27 years of available data. Years in which Red Snapper were not observed, respective to the west, northeast/central and east Gulf of Mexico were removed prior to the generation of indices.

**Standardization:** Delta-lognormal generalized linear models were used to generate age corrected abundance indices for the west and northeast/central Gulf of Mexico, and a binomial generalized linear model was used to generate a relative index based on the proportion of positive occurrence in the east Gulf of Mexico.

**Submodel Variables**

**West:**

Binomial: *Year + Time of Day + Subregion*

Positive Observations: *Year + Time of Day + Subregion*

**Updated Northeast/Central:**

Binomial: *Year + Time of Day + Subregion*

Positive Observations: *Year + Subregion + Depth*

**East:**

Binomial: *Year*

**Annual Abundance Indices:** See Table 4 (west), Addendum Table 1 (northeast/central) and Table 7 (east) in working paper.

5.4.9.2. Comments on Adequacy for Assessment

Initial indices presented to the IWG included delta-lognormal standardized indices of age corrected larval abundance for the west and northeast/central regions, and a proportion of positive occurrence for the east region. The IWG raised concerns with the timing of the SEAMAP Fall Plankton Survey (late August and September) which is conducted towards the end of the Red Snapper spawning season and outside of peak spawning. Thus, raising the question as whether the indices were adequately capturing population trends. Particularly, in the east region where larvae were rarely taken. The IWG also requested discussions be held with the life history group in regard to the timing of the survey and the capturing of trend. Based on these discussions and the rare catch of larvae, the east index was not recommended by the IWG as suitable to move forward for the assessment phase. The IWG also requested a re-analysis of the northeast/central delta-lognormal index to include samples from the 2015 and 2017 SEAMAP Fall Plankton Surveys with partial spatial coverage in the MS/AL and FL subregions. The updated northeast/central index was presented, discussed during the Data Workshop and recommended by the IWG to replace the initial index. The west and updated northeast/central indices were recommended by the IWG as suitable to move forward to the assessment phase.

5.4.10 FWRI Artificial Reef Video Survey

The Fish and Wildlife Research Institute (FWRI) began using stereo-baited remote underwater video survey (S-BRUV) to assess trends in reef fish species in 2008 on the West Florida Shelf (WFS) to supplement ongoing NOAA surveys that focused on different habitats or were limited

in geographic scope. These initial efforts were focused on natural reefs offshore of Tampa Bay and Charlotte Harbor but funding through the National Fish and Wildlife Fund (NFWF) expanded the survey to cover the entirety of the WFS region from zones 2-10. These data contribute to the natural reef combined video index. Part of this expansion was the inclusion of artificial reef habitats as a stratum within the mapping and sampling protocol. Efforts on these habitats began in 2014 in the Panhandle and in 2016 for the remainder of the state. These efforts have continued through funding from the NOAA Restore Science program starting in 2020. Given the time series of these surveys as well as ongoing interest in incorporation information from artificial reef habitats into the Red Snapper assessment, we developed an index for these habitats for the two regions identified in the stock ID process.

#### 5.4.10.1. Methods of Estimation

**Working Paper Number:** SEDAR74-DW-27

**Data Type:** Fishery Independent

**Time Series:** 2014-2020 (central); 2016-2020 (east)

**Sampling Intensity:** See Table 1 in working paper for both regions by survey.

**Size/Age Data:** Represents juvenile through adult biomass; see Figure 3 in working paper.

**Data Filtering Techniques:** For all surveys, video reads were excluded if they were unreadable due to turbidity or deployment errors. Sites included were targeted on artificial reefs identified to artificial structures during side-scan mapping before setting the camera only.

**Standardization:** Due to the general zero-inflated nature of these data, as with other indices using the video data, a negative binomial GLM was fit to predict annual MaxN. All potential habitat variables were initially used in the model which included spatial data such as latitude, longitude, depth as well as the landscape level habitat as side-scan geofom, and finally site-specific variables which were the amount of relief seen at a site on video and percent coverage and the presence/absence of sponge, rock, algae, hard corals, soft corals, unknown sessile organisms, and seagrass. Models for each region were backwards selected by sequentially removing non-significant variables to find the most parsimonious model using AIC as criteria. Final models for the two regions were (where per=percent cover, and pa=presence/absence):

##### **Submodel Variables**

Central: year + latitude + longitude + artificial habitat\_pa + rock\_per + algae\_pa

East: year + depth + latitude + longitude + algae\_per + scoral\_per + sponge\_per + rock\_per + artificial habitat\_per

**Annual Abundance Indices:** see Table 2 in working paper.

#### 5.4.10.2. Comments on Adequacy for Assessment

This index was not deemed suitable for the east region given the low sample sizes, very low proportion positive and the limited time series. The central region was suitable yet not

recommended for the short time series, smaller spatial footprint, and relatively flat trend in abundance. However, continued data collection and exploration of generating time series from this survey was recommended by the IWG and overall panel.

#### 5.4.11 *DISL Bottom Longline*

The Dauphin Island Sea Lab (DISL) has conducted fishery-independent shark bottom longline surveys in the north-central GOM off Alabama since 2010. The gear used during the survey is similar to that used by the SEFSC Bottom Longline Survey but utilizes a different sampling design.

##### 5.4.11.1. Methods of Estimation

**Working Paper Number:** SEDAR74-DW-26

**Data Type:** Fishery Independent

**Time Series:** 2010 – 2019

**Sampling Intensity:** Table 13 (central) in working paper.

**Size/Age Data:** Primarily age-2+ adult fish.

**Data Filtering Techniques:** Standard filtering protocols to remove problematic stations.

**Standardization:** Delta-lognormal

##### **Submodel Variables**

Binomial: Year

Positive: Year

**Annual Abundance Indices:** Table 13 (central) in working paper.

##### 5.4.11.2. Comments on Adequacy for Assessment

The IWG found this survey to have an acceptable statistical design with good temporal coverage. However, this survey has limited spatial coverage, mainly off the coast of Alabama (Figure 5.10.1), that may not be representative of the entire central region for red snapper. This survey also catches the same size class of individuals that are captured in the SEFSC Bottom Longline Survey, which covers the entire central region. Therefore, the IWG determined that the DISL Bottom Longline Survey was ‘Suitable and Not Recommended’ for use in the stock assessment.

#### 5.4.12 *NOAA Fisheries SEFSC Bottom Longline Survey / DISL Bottom Longline Survey*

This is a combination of the SEFSC Bottom Longline Survey (Section 5.3.1) and the DISL Bottom Longline Survey (Section 5.3.11) datasets for the Central Region.

##### 5.4.12.1. Methods of Estimation

**Working Paper Number:** SEDAR74-DW-26

**Data Type:** Fishery Independent

**Time Series:** 2001 – 2019

**Sampling Intensity:** Table 11 (central) in working paper.



**Size/Age Data:** Primarily age-2+ adult fish.

**Data Filtering Techniques:** Standard filtering protocols to remove problematic stations.

**Standardization:** Delta-lognormal, Conn Method

**Submodel Variables**

Binomial: Year + Zone

Positive: Year + Zone

**Annual Abundance Indices:** Table 11 (central) in working paper.

#### 5.4.12.2. Comments on Adequacy for Assessment

Several analytical approaches were attempted on this dataset to try to combine the data from the SEFSC Bottom Longline Survey and the DISL Bottom Longline Survey. The main issue is that the DISL survey samples in a small spatial area with high abundance in the central region (off Alabama), whose abundance trends overweight the signal from the SEFSC Bottom Longline Survey, which samples across the entirety of the central region (Figure 5.10.1). When compared to the indices from solely the DISL Bottom Longline Survey, the combined index has almost an identical trend to lead to the discussion of how the DISL data was driving the entire index trend and overwhelming the data from the rest of the central region. The Conn Method was attempted as an alternative to the delta-lognormal model, but it appeared to just average the two indices. It is the recommendation of the IWG that this index needs more research on the proper way to combine the datasets, while properly accounting for the weighting of the different survey areas. Therefore, this index was deemed ‘Suitable and Not Recommended’ for the assessment.

#### 5.4.13 SEAMAP Vertical Line Survey

We developed a set of fishery-independent indices of abundance for Gulf of Mexico Red Snapper based on SEAMAP vertical line catch data collected between 2012 and 2021. The indices were fit using type 1 negative binomial GLMs with zero-inflation mixture components. Indices were fit to different conditional models including, Year only, Year \* Habitat, Year \* Depth, and Year \* Zone. We also fit three independent indices for each of the three spatial zones (west, central, and east) described in “Option C” of the SEDAR 74 Stock ID Report.

#### 5.4.13.1. Methods of Estimation

**Working Paper Number:** SEDAR74-DW-39

**Data Type:** Fishery Independent

**Time Series:** 2012-2021

**Sampling Intensity:** Tables 1 (west), 2 (central) and 3 (east) in working paper

**Size/Age Data:** Figure 1

**Data Filtering Techniques:** NA

**Standardization:** type 1 negative binomial with zero-inflation mixture component

**Model Variables:** year, zone, depth stratum, habitat type

**Annual Abundance Indices:** Table 12 (west, central and east) in working paper.

#### 5.4.13.2. Comments on Adequacy for Assessment

The consensus of the workshop participants was that the index was unsuitable for use in the assessment for the following reasons: (1) lack of representative spatiotemporal sampling, particularly in early years of time series, (2) apparent habitat bias, particularly in early years of time series, (3) if early years of time series are censored due to reasons 1 & 2, the index covers too short a time period, and (4) there were concerns that the vertical line gear may be susceptible to saturation at locations with high abundance.

### 5.5 FISHERY-DEPENDENT INDICES

#### 5.5.1 Recreational (Charterboat and Private)

A delta-lognormal index of abundance for the Gulf of Mexico Charterboat and Private combined recreational fishery was constructed for the SEDAR74 Operational Red Snapper stock assessment. The index uses recreational fishery data obtained from the Marine Recreational Information Program, LA Creel Survey and Texas Parks and Wildlife. Indices for the Gulf of Mexico east, central and west regions were developed following the trip selection approach and standardization methodology used for SEDAR52 and SEDAR31.

##### 5.5.1.1. Methods of Estimation

**Working Paper Number:** SEDAR74-DW-13

**Data Type:** Fishery Dependent

**Time Series:** 1981-2019

**Sampling Intensity:** Tables 10 (west), 8 (central) and 6 (east) in working paper.

**Size/Age Data:** NA

**Data Filtering Techniques:** Stevens-McCall

**Standardization:** Delta-censored lognormal

##### **Submodel Variables**

Binomial: Year, regulation season, anglers, area and wave (central region)

Binomial: Year, area, anglers and regulation season (west region)

Censored Lognormal: year, wave and mode (central region)

Censored Lognormal: year, wave and mode (west region)

**Annual Abundance Indices:** Tables 10 (west), 8 (central) and 6 (east) in working paper.

##### 5.5.1.2. Comments on Adequacy for Assessment

During the Data Workshop IWG, several different approaches were attempted for the index standardization due to concerns surrounding changes in management. The nominal index on the full times series for the central region was outside the confidence interval of the standardized index beginning in 2007 (SEDAR74-DW-13 Figure 16). This corresponds to a shift in the red snapper bag limit from four to two fish as well as the reduction in open fishing days of red

snapper in 2007. The three region indices were all based on type “A” catches, which does not fully reflect all the fish caught by the recreational fishery. A second set of indices were constructed during the Data Workshop, ones based off A, B1 and B2 type catches. This encompassed both observed caught red snapper (A), unobserved caught red snapper (B1) and unobserved released red snapper (B2). The east region still lacked sufficient data to construct an index and the west region index could not be attempted, as discards are not collected by Texas. A delta lognormal was used to standardize the AB1B2 catches, as the censored approach was not needed to account for bag limits on the landed and discarded catches. The central nominal index of AB1B2 catches remained outside the standardized confidence interval after management regulations went into effect and exhibited a flat trend in recent years (SEDAR74-DW-13 Figure 17).

Stakeholders attending the webinar noted that effort has been increasing in recent years in the forms of larger vessels and engines and that fishing behavior has changed due to the implementation of federal and state regulations. These changes in the types of effort metrics noted by the stakeholders are not recorded by MRIP and therefore cannot be accounted for through standardization methods. The IWG concluded that due to changes in management regulation, fisher behavior and effort, the Charterboat and Private indices do not reflect the underlying population of red snapper in the Gulf of Mexico and did not recommend them for use in the assessment.

### 5.5.2 Southeast Region Headboat Survey

The Southeast Region Headboat Survey (SRHS) collects data on the catch and effort for individual headboat trips. Reported information includes landing date and location, vessel identification, the number of anglers, a single fishing area for the entire trip, trip duration and/or type (half/three-quarter/full/multi-day, day/night, morning/afternoon), and catch by species in number and weight. Headboats operate based on the federal season and use hook and line gear. They generally target hard bottom reefs as the fishing grounds and multiple species in the snapper-grouper complex.

#### 5.5.2.1 Methods of Estimation

**Working Paper Number:** SEDAR74-DW-21

**Data Type:** Fishery Dependent

**Time Series:** 1986-2019

**Sampling Intensity:** See Table 1 in working paper for number of annual trips by Stock ID region and percent of trips positive for red snapper catch.

**Size/Age Data:** Age 2+

**Data Filtering Techniques:** Major data filtering included selecting only trips from April 21<sup>st</sup> to Nov 1<sup>st</sup> 1986 – 2007 and the Stephens and McCall (2004) trip selection approach to determine trips that occurred in red snapper habitat since no direct targeting information was available.

**Standardization:** Delta censored lognormal regression

**Submodel Variables**

West:

Binomial: Year + Area + Season + Anglers\* + Trip Type\*

Positive Observations: Year + Area + Season

Central:

Binomial: Year + Trip Type\*

Positive: Year + Season

East:

Binomial: Year + Area + Season

Positive: Year + Season

\*\*Only explored as factors for modeling success because these factors were confounded with effort for the CPUE response variable in the lognormal model.

**Annual Abundance Indices:** Table 6 (west), 7 (central) and 8 (east) in working paper.

#### 5.5.2.2. Comments on Adequacy for Assessment

The indices presented at the data workshop for the IWG included the standardized indices for the central and west regions, and the nominal index for the east region (due to a lack of model convergence for the east index). All data used in the indices were filtered to dates between April 21<sup>st</sup> and Nov 1<sup>st</sup>, 1986 – 2007. The west and central indices were recommended by the IWG as suitable to move forward to the assessment phase but with some caveats.

In the west region, the SRHS index can be considered for investigation but may not be needed in favor of a fishery independent survey that covers the same temporal range. Considering all other presented indices, there was a 4-year gap in the available information in the west that the SRHS data could potentially inform. The assessment team can explore the usefulness of these additional data points to the model. If the west index is used in the assessment model, the assessment analysts should be aware of the potential conflict in relative abundance trends in the early time period between the SRHS data and the other indices for the west.

In the central region, the SRHS index is recommended for use in the assessment, as it was one of the only time series that extended back to 1986.

#### 5.5.3 Commercial Vertical Line (Pre IFQ)

Standardized catch-per-unit-effort indices of relative abundance were derived from data collected on commercial vertical line fisheries operating in the Gulf of Mexico. East, central, and west stock ID area indices were developed using fishery dependent data collected from the Coastal Fisheries Logbook Program (CFLP). All main effects and first order interactions were tested during model development and the final models were selected using a forward stepwise regression approach and AIC. For all areas, indices were truncated at 2006 due to the commercial vertical line fishery shifting to an IFQ program in 2007.

## 5.5.3.1. Methods of Estimation

**Working Paper Number:** SEDAR74-DW-17

**Data Type:** Fishery Dependent

**Time Series:** 1993 - 2006

**Sampling Intensity:** Average sample size

East – 162

Central – 975

West – 1,673

**Size/Age Data:** Dome-shaped selectivity with peak selection occurring at age 4-5.

**Data Filtering Techniques:** Stevens-McCall

**Standardization:** delta-lognormal

**Submodel Variables**

*Year, Month, Shrimp Statistical Grid (Area), Crew Size (Crew), Days Fishing (Away), and Hook Hours\* (lines fished\*hooks per line\* hours fished).*

*\* Hook Hours only tested in the binomial model*

**Annual Abundance Indices:** Tables 3 (west), 2 (central) and 1 (east) in working paper.

## 5.5.3.2. Comments on Adequacy for Assessment

During the SEDAR 74 data workshop the IWG reviewed the commercial vertical line pre-IFQ (ComVL) indices with the goal of determining if the indices were both suitable and recommended for assessment. An index was classified as suitable for use if it was determined to have been constructed from data appropriate for index development using well-documented statistical methods that produced standardized indices of abundance and measures of uncertainty. If an index was deemed suitable for use in assessment, it was then evaluated alongside all other suitable indices within a given stock ID area. Recommended indices were those that used the highest quality data and/or covered a year-range or age/size-structure that was not represented by the other recommended indices.

Upon review by the SEDAR 74 IWG, the ComVL indices for the east, central, and west stock ID areas were determined to be suitable for use in assessment. While the indices for all stock ID areas were considered suitable for use, only the east and were recommended for use in the SEDAR 74 stock assessment. When recommended, the ComVL indices were included due to their historic temporal coverage. The indices were not recommended when the stock ID area had fishery independent indices of abundance that provided similar temporal coverage as the ComVL.

## 5.5.4 Commercial Vertical Line (Post IFQ)

There are concerns that catch-per-unit-effort (CPUE) abundance indices based on commercial fleet landings may not be valid after implementation of individual fishing quotas (IFQs) for

selected grouper-snapper species in the Gulf of Mexico (GOM). To address these concerns, a novel CPUE index was developed in 2020-2021 for scamp and yellowmouth grouper for the commercial fleet using data from the reef fish observer program (Smith et al. 2021). Observer observations of catch include both kept and discarded fish, and are thus not directly impacted by changes in management regulations (e.g., minimum size, catch quotas, etc.). This methodology was applied to develop commercial fleet CPUE indices for red snapper for SEDAR 74.

#### 5.5.4.1. Methods of Estimation

**Working Paper Number:** SEDAR74-DW-39

**Data Type:** Fishery Dependent

**Time Series:** 2007-2019

**Sampling Intensity:** Tables 1 (west), 2 (central) and 3 (east) in working paper.

**Size/Age Data:** Length composition was collected by observers; see abundance indices below.

**Methods Overview:** Reef fish observer data for vertical line gear have much in common with fishery-independent surveys utilizing fishing gears, including: latitude-longitude coordinates were recorded at each specific fishing location, catches were recorded for individual species, and lengths were recorded for individual fish (Scott-Denton et al. 2011). A probability survey approach was thus used for estimation of the reef fish observer CPUE index. The spatial sample frame was delineated as 500x500 m grid cells (i.e., sample units) encompassing the full range of red snapper observed depths in the west, central, and east GOM. Analysis techniques accounted for varying gear characteristics (e.g., hook types, hook sizes, etc.) and varying effort (e.g., number of lines, fishing time at a location, etc.) in the estimation procedure. Analysis and estimation methods were presented to the IWG, and are documented in an accompanying working paper (Smith 2022).

**Data Filtering Techniques:** Initial filtering steps restricted data to vertical line gears, and excluded observations with missing location information (i.e., latitude-longitude). This enabled assignment of observations at specific fishing locations to a unique 500x500 m grid cell with associated depth information, and subsequent restriction of observations to the observed red snapper depth range of 10-140 m.

Red snapper length frequency distributions were found to differ with respect to hook type (j-hooks vs. circle hooks) as well as hook size. Data were subsequently filtered to include circle hooks, which accounted for over 90% of observations, for two distinct hook size categories (small and large) based on hook shaft length measurements taken by observers.

Species co-occurrence analysis following methods of Mackenzie et al. (2006) was used to identify valid red snapper sample units, i.e., sample units with a non-zero probability of catching scamp: fishing samples were included if either red snapper or a positively-associated species were captured.

Previous analyses for scamp/yellowmouth grouper identified line-hours as the most appropriate effort variable for CPUE estimation. High values of line-hours exceeding the 99<sup>th</sup> percentile were excluded as outliers.

**Effort Standardization:** Line-hours were standardized for the two hook size categories and two reel types (hand, mechanical) using the fishing power approach (Robson 1966), which estimates the relative catchability ( $q$ ) among gears, and then converts effort of each gear in terms of a designated standard gear. Estimation of fishing power was carried out using a compound pdf generalized linear model (GLIM), which analyzed presence-absence using a logistic regression model and catch-when-present using a gamma pdf GLIM. Small circle hooks with mechanical reels was designated as the standard gear. Effort for other gears was converted to that of the standard gear, and the data were pooled for estimating the CPUE index.

**Annual Abundance Indices:** Annual estimates of red snapper CPUE and associated variance were estimated using a Hurwitz-Thompson ratio-of-means estimator for a stratified sample frame (Lohr 2010). Estimation was carried out separately for the west, Central, and east subregions of the GOM. Depth stratification within each subregion was effective with respect to spatial partitioning of sample variance for CPUE. Spatial strata weighting controlled for potential bias of subregion CPUE estimates due to disproportionate sampling in relation to depth strata. Strata-weighted annual length compositions were computed following the procedures of Smith et al. (2022).

Estimates of the reef fish observer abundance index for GOM red snapper for 2007-2019 for the commercial vertical line fleet are provided in Tables 1, 2 and 3 for the respective west, central, and east subregions.

#### 5.5.4.2. Comments on Adequacy for Assessment

During the SEDAR 74 data workshop, the IWG reviewed the observer post-IFQ commercial vertical line indices with the goal of determining if the indices were both suitable and recommended for assessment. An index was classified as suitable for use if it was determined to have been constructed from data appropriate for index development using well-documented statistical methods that produced standardized indices of abundance and measures of uncertainty. If an index was deemed suitable for use in assessment, it was then evaluated alongside all other suitable indices within a given stock ID area. Recommended indices were those that used the highest quality data and/or covered a year-range or age/size-structure that was not represented by the other recommended indices.

Upon review by the SEDAR 74 IWG, the ComVL indices for the east, central, and west stock ID areas were determined to be suitable for use in assessment. While the indices for all stock ID areas were considered suitable for use, only the east index was recommended for use in the

SEDAR 74 stock assessment. When recommended, the ComVL indices were included due to their historic temporal coverage. The indices were not recommended when the stock ID area had fishery independent indices of abundance that provided similar temporal coverage as the ComVL.

## 5.6 RECRUITMENT INDEX BASED ON THE CONNECTIVITY MODELING SYSTEM

The Connectivity Modeling System (CMS) is a biophysical modeling system based on a Lagrangian framework and was developed to study complex larval migrations. The CMS uses outputs from hydrodynamic models and tracks the three-dimensional movements of advected particles through time, given a specified set of release points and particle behaviors, while simulating realistic larval behaviors such as ontogenetic vertical migration. Specifics on the hydrodynamic model forcing the simulation, and other details on how the simulation was parameterized specific to red snapper biology, are described in SEDAR 74-RD-71. The recruitment index is a measure of the proportion of larvae that are expected to successfully settle to suitable recruitment habitat within the given biological constraints, due to the effects of oceanographic currents. The index thus represents a scalar on the total larval supply expected each year, prior to any density-dependent processes that act on the larvae upon settlement. Variance estimates for the index are obtained by running a range of sensitivities to the assumed larval depth distribution, providing a mean and annual standard deviation for the index.

## 5.7 RESEARCH RECOMMENDATIONS

- Explore alternative methods for properly weighting the DISL BLL survey in order to incorporate it with the NOAA Fisheries BLL survey
- Explore utility of design based index estimator for Gulfwide video survey
- Calibration of optical and acoustic imaging systems to better sample low visibility environments
- Explore alternative trip selection protocols that can account for changing regulations and angler behavior
- Explore influence of interacting species on gear selectivity and catchability

## 5.8 LITERATURE CITED

- Lo, N.C.H., L.D. Jacobson, and J.L. Squire. 1992. Indices of relative abundance from fish spotter data based on delta-lognormal models. *Canadian Journal of Fisheries and Aquatic Science* 49:2515-2526.
- Lohr, S.L. 2010. *Sampling: design and analysis*, 2nd ed. Boston: Brooks/Cole.
- Mackenzie, D.I., Nichols, J.D., Royle, J.A. Pollock, K.H., Bailey, L., Hines, J.E. 2006. *Occupancy estimation and modeling: inferring patterns and dynamics of species occurrence*. Academic Press.



Nichols, S. 2004. Derivation of red snapper time series from SEAMAP and groundfish trawl surveys. SEDAR7-DW01.

Robson, D.S. 1966. Estimation of the relative fishing power of individual ships. ICNAF. Res. Bull. 3:5-15.

SEDAR 74 Stock ID. 2021. Gulf of Mexico Red Snapper Stock ID Process Final Report. Available: [http://sedarweb.org/docs/page/S74\\_Stock\\_ID\\_Report\\_FINAL\\_v4\\_watermark.pdf](http://sedarweb.org/docs/page/S74_Stock_ID_Report_FINAL_v4_watermark.pdf)

Scott-Denton, E., Cryer, P.F., Gocke, J.P., Harrelson, M.R., Kinsella, D.L., Pulver, J.R., Smith, R.C., Williams, J. 2011. Descriptions of the U.S. Gulf of Mexico reef fish bottom longline and vertical line fisheries based on observer data. Marine Fisheries Review 73(2):1-26.

Smith, S.G., S. Sagarese, S. Martinez-Rivera, K.J. McCarthy. 2021. Estimation of a commercial index for Gulf of Mexico scamp & yellowmouth grouper using reef fish observer data. SEDAR Working Paper SEDAR68-AW-04. SEDAR, North Charleston, SC. 34 pp.

Smith, S.G. 2022. Estimation of vertical line commercial indices for Western, Central, and Eastern Gulf of Mexico red snapper using reef fish observer data. SEDAR Working Paper SEDAR74-DW-38. SEDAR, North Charleston, SC.

Smith, S.G., S. F. Atkinson, and S. Martinez-Rivera. 2022. Estimation of length composition of commercial discards for Gulf of Mexico red snapper. SEDAR Working Paper SEDAR74-DW-37. SEDAR, North Charleston, SC.

## 5.9 TABLES

**Table 5.9.1.** Sampling effort (N), relative abundance (Index) scaled to a mean of one for each time series and the coefficient of variation on the mean (CV, standard error/mean) of west Gulf of Mexico indices recommended for consideration in the assessment.

Year	SEFSC Bottom Longline			SEAMAP SGF - Old 1982-2008			SEAMAP SGF - New 2009-2019			SEAMAP FGF - Old 1988-2007		
	N	Index	CV	N	Index	CV	N	Index	CV	N	Index	CV
1984				161	0.74713	0.28624						
1985				77	1.11016	0.3086						
1986				79	0.29356	0.43855						
1987				178	0.71006	0.22079						
1988				145	0.34651	0.24776				181	0.42781	0.14968
1989				141	0.25619	0.30539				180	0.85672	0.14082
1990				172	2.26208	0.16018				175	0.90854	0.12376
1991				185	1.02087	0.18827				179	1.02731	0.11777
1992				180	0.64442	0.1977				179	0.31611	0.15075
1993				178	0.70395	0.19391				177	0.57429	0.14108
1994				177	1.34549	0.17943				179	1.62501	0.12146
1995				176	1.17612	0.1702				177	1.74663	0.11071
1996				174	1.30854	0.17055				181	0.86993	0.12869
1997				163	0.99397	0.17211				178	1.29003	0.12559
1998				169	0.88587	0.1919				181	0.59505	0.14396
1999				179	0.75858	0.19287				182	1.37449	0.11653
2000				171	1.39109	0.15399				179	0.90717	0.1181
2001	124	0.32272	0.25898	116	0.78658	0.26337				184	0.68066	0.13467
2002	150	0.24739	0.2234	183	1.09421	0.17058				181	0.64987	0.13396
2003	100	0.28885	0.28409	137	0.61355	0.21065				183	1.15195	0.12107
2004	95	0.34471	0.28458	177	1.33104	0.16223				162	1.79825	0.1094
2005				148	1.50193	0.16631				186	1.27156	0.10272
2006	71	0.27649	0.35084	176	1.41881	0.14692				176	1.08383	0.12343
2007	70	0.29871	0.34949	155	1.16578	0.1824				173	0.84479	0.14374
2008				206	1.13354	0.15471						
2009	76	0.51429	0.26035				301	0.36643	0.15392			
2010	46	0.25183	0.46088				201	0.86976	0.14973			
2011	139	0.70517	0.19059				171	1.21008	0.14826			
2012	53	1.24024	0.27629				176	0.83538	0.14179			
2013	63	1.14287	0.25134				141	1.30822	0.16676			
2014	47	0.86446	0.30549				162	0.79263	0.16255			
2015	56	2.12482	0.22997				168	1.08551	0.15037			
2016	54	1.76134	0.22033				162	0.89431	0.15118			
2017	67	2.69753	0.16413				161	0.85424	0.16141			
2018	59	1.5612	0.22425				135	1.63878	0.13971			
2019	48	2.3574	0.2253				145	1.14466	0.15603			

**Table 5.9.1 (continued).** Sampling effort (N), relative abundance (Index) scaled to a mean of one for each time series, and the coefficient of variation on the mean (CV, standard error/mean) of west Gulf of Mexico indices recommended for consideration in the assessment.

Year	SEAMAP FGF - New 2008-2019			SEAMAP Fall Plankton			SEAMAP Reef Fish Video			Southeast Region Headboat Survey		
	N	Index	CV	N	Index	CV	N	Index	CV	N	Index	CV
1984												
1985												
1986				49	0.2823	0.6320				970	0.8600	0.2100
1987				55	0.4391	0.6333				970	0.8900	0.2000
1988										986	1.0700	0.2000
1989				28	0.5494	0.6198				1,023	0.9600	0.2000
1990				31	0.4452	0.5060				1,054	0.6700	0.2000
1991				31	0.2149	0.7220				1,115	1.2700	0.2100
1992				55	0.2536	0.4771				1,538	1.7800	0.2100
1993				55	0.2692	0.4772	45	0.1400	0.1543	1,671	1.6700	0.2000
1994				55	0.1973	0.6324	45	0.3400	0.1817	1,832	1.2300	0.1800
1995				55	0.7589	0.3384	44	0.3100	0.2134	1,687	1.4300	0.2000
1996				55	0.534	0.4148	165	0.7000	0.1967	1,494	1.5400	0.2300
1997				54	0.8922	0.3240	127	1.5500	0.2065	1,487	1.5800	0.2000
1998										1,301	1.1800	0.2000
1999				55	0.3805	0.4419				515	0.3900	0.3000
2000				55	1.2189	0.3169				1,199	0.6900	0.2000
2001				47	0.8468	0.4718				1,356	0.8100	0.2600
2002				54	0.6436	0.3517	93	1.0800	0.2163	1,417	0.7100	0.2400
2003				54	1.2069	0.2997				1,320	0.6200	0.2200
2004				54	0.6848	0.3575	51	0.9500	0.1647	1,457	0.4700	0.2200
2005							136	0.9600	0.2023	1,464	0.5300	0.2200
2006				52	1.1941	0.3548	139	0.3800	0.2140	1,384	0.5700	0.2400
2007				55	1.0471	0.2979	171	1.0200	0.1709	1,484	1.0900	0.2700
2008	286	0.44531	0.10027				131	0.7200	0.1899			
2009	273	1.47183	0.09172	55	1.2756	0.2903	167	1.0800	0.2343			
2010	176	0.69347	0.12964	53	0.5209	0.4415	106	2.2400	0.1963			
2011	177	0.81607	0.12176	53	2.1040	0.3357	103	1.7400	0.2397			
2012	132	1.57527	0.12207	55	1.9798	0.2910	200	1.8700	0.1961			
2013	91	0.66354	0.18001	54	1.0537	0.2992	136	2.6200	0.2058			
2014	146	0.90006	0.12683	52	1.5505	0.3214	113	3.4900	0.1726			
2015	144	1.64949	0.11665				48	2.1400	0.1980			
2016	118	1.10622	0.15101	55	3.1776	0.2682	168	2.6400	0.2268			
2017	143	0.765	0.14591	53	0.8388	0.3522	189	3.0400	0.2055			
2018	142	1.07697	0.12548	53	1.5928	0.2777	194	6.0400	0.1978			
2019	137	0.83676	0.14676	47	2.8477	0.2387	265	3.3400	0.1816			

**Table 5.9.2.** Sampling effort (N), relative abundance (Index) scaled to a mean of one for each time series, and the coefficient of variation on the mean (CV, standard error/mean) of central Gulf of Mexico indices recommended for consideration in the assessment.

Year	SEFSC Bottom Longline			SEAMAP SGF – New 2009-2019			SEAMAP FGF – New 2008-2019			SEAMAP Fall Plankton		
	N	Index	CV	N	Index	CV	N	Index	CV	N	Index	CV
1981												
1982												
1983												
1984												
1985												
1986												
1987												
1988												
1989												
1990												
1991										17	0.1200	1.2117
1992												
1993												
1994										33	0.0314	1.2239
1995										30	0.0603	1.2234
1996												
1997										32	0.0884	1.2196
1998												
1999										33	0.3690	0.7212
2000										33	0.8043	0.6277
2001	55	0.15237	0.88290							31	0.1530	0.7130
2002	48	0.10488	0.88624									
2003	55	0.24000	0.72815							32	0.3974	0.6220
2004										33	0.1586	1.2240
2005												
2006	14	0.14765	1.22517							33	0.6077	0.7167
2007										33	0.8912	0.5008
2008							50	0.60397	0.33950	25	0.0906	1.2148
2009	32	0.32922	0.73190	140	0.44691	0.27059	107	2.28064	0.18760	33	0.5059	0.7150
2010	32	1.12868	0.50307	71	1.01429	0.31763	85	0.69305	0.28053	32	2.7249	0.4142
2011	97	1.51067	0.29569	64	0.56773	0.37691	42	0.57036	0.34558	33	0.9057	0.7222
2012	22	1.03395	0.72472	80	1.07656	0.31270	51	1.36823	0.29081	27	0.7881	0.5416
2013	38	0.49373	0.74039	67	1.37233	0.34904	57	0.70064	0.33441	33	0.8545	0.5438
2014	24	1.85775	0.46027	91	0.68369	0.31524	55	0.97828	0.29420	31	1.4842	0.5494
2015	38	2.13419	0.41541	101	0.65342	0.34799	62	1.29191	0.27548	19	0.4687	1.2215
2016	42	2.28623	0.45247	81	0.95237	0.29861	36	0.98483	0.41426	33	1.0315	0.4485
2017	24	0.79160	0.56928	88	1.67192	0.22371	76	0.56256	0.27826	23	4.2551	0.2941
2018	33	1.07228	0.56710	66	1.14448	0.31295	56	1.27098	0.27251	32	1.8049	0.4214
2019	20	1.71680	0.61978	78	1.41630	0.29393	51	0.69456	0.32661	29	4.4050	0.3188

**Table 5.9.2 (continued).** Sampling effort (N), relative abundance (Index) scaled to a mean of one for each time series, and the coefficient of variation on the mean (CV, standard error/mean) of central Gulf of Mexico indices recommended for consideration in the assessment.

Year	Combined Reef Fish Video			Southeast Region Headboat Survey		
	N	Index	CV	N	Index	CV
1981						
1982						
1983						
1984						
1985						
1986				259	0.17000	0.38000
1987				436	0.15000	0.31000
1988				713	0.19000	0.25000
1989				726	0.22000	0.25000
1990				835	0.30000	0.24000
1991				971	0.35000	0.22000
1992				1,066	0.67000	0.22000
1993	26	0.09741	0.57081	1,179	0.71000	0.22000
1994	24	0.08574	0.70649	1,183	0.52000	0.21000
1995	13	0.04870	1.09378	1,392	0.58000	0.20000
1996	39	0.13690	0.44562	1,460	0.72000	0.22000
1997	41	0.25866	0.33672	1,566	1.28000	0.27000
1998				1,399	1.66000	0.33000
1999				834	1.12000	0.28000
2000				1,537	1.69000	0.26000
2001				1,451	1.62000	0.28000
2002	46	0.60902	0.26021	1,617	2.46000	0.34000
2003	64	1.18576	0.20357	1,721	1.95000	0.28000
2004	126	0.97289	0.17316	1,499	1.57000	0.29000
2005	203	0.96136	0.18208	1,303	1.35000	0.33000
2006	212	1.56115	0.19131	1,310	0.84000	0.32000
2007	141	1.38441	0.15066	1,238	1.90000	0.51000
2008	195	1.81834	0.14053			
2009	213	1.64643	0.12213			
2010	287	1.59289	0.10499			
2011	218	0.85330	0.13124			
2012	148	1.04232	0.15704			
2013	233	0.95279	0.18277			
2014	188	0.78473	0.13857			
2015	444	1.37161	0.09877			
2016	406	1.50448	0.11062			
2017	371	1.08306	0.15943			
2018	564	1.50381	0.10567			
2019	164	1.54425	0.13500			

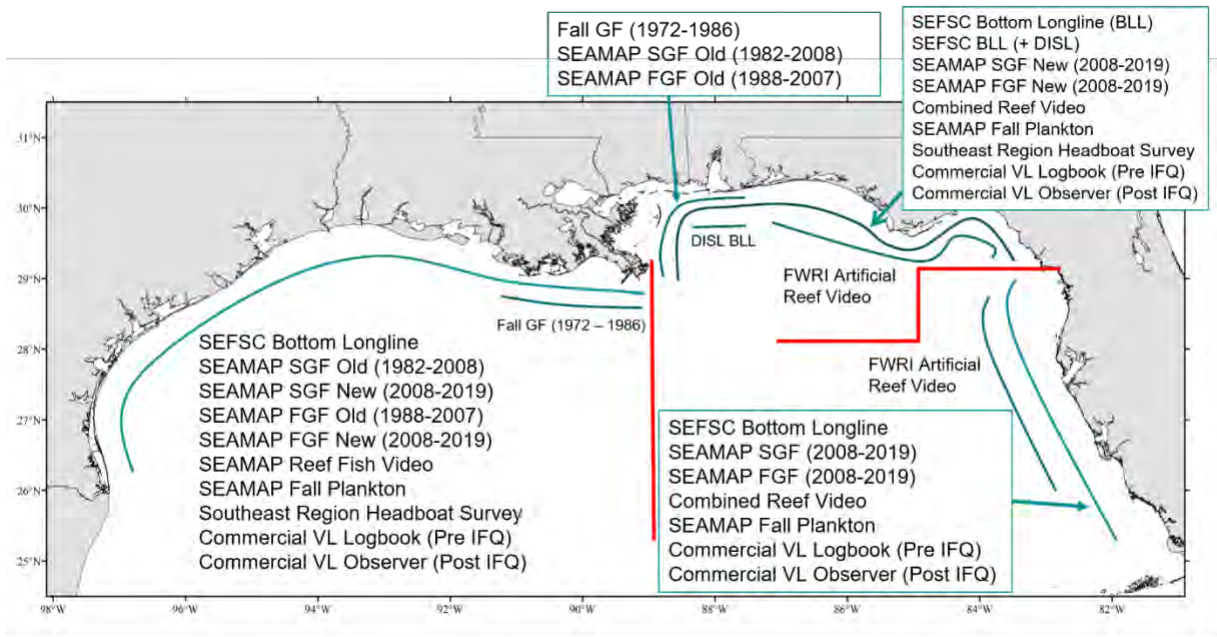
**Table 5.9.3.** Sampling effort (N), relative abundance (Index) scaled to a mean of one for each time series, and the coefficient of variation on the mean (CV, standard error/mean) of east Gulf of Mexico indices recommended for consideration in the assessment.

Year	SEFSC Bottom Longline			SEAMAP SGF – New 2009-2019			SEAMAP FGF – New 2008-2019			Combined Reef Fish Video		
	N	Index	CV	N	Index	CV	N	Index	CV	N	Index	CV
1981												
1982												
1983												
1984												
1985												
1986												
1987												
1988												
1989												
1990												
1991												
1992												
1993												
1994												
1995												
1996												
1997												
1998												
1999												
2000												
2001	67	0.12015	1.15202									
2002												
2003	96	0.42597	0.81321									
2004	87	0.68704	0.66200									
2005	43	0.52529	1.14653									
2006	43	0.25678	1.14319									
2007	37	1.73555	0.79655									
2008							29	0.66509	0.78822			
2009	54	1.16084	0.57105	88	0.09735	0.91896	66	0.40885	0.53266			
2010	48	1.85093	0.49667	104	0.03350	1.26022	61	0.72140	0.43027	186	0.47611	0.33185
2011	140	1.77124	0.31908	106	1.17019	0.50238				413	0.62507	0.23062
2012	45	0.48289	0.80844	143	0.55628	0.44159	17	0.93305	0.77485	427	0.31771	0.23106
2013	37	2.85228	1.14085	106	0.17358	0.91565	49	0.17427	0.77531	285	0.71539	0.31198
2014	31	0.35960	1.13798	123	0.37885	0.44236	109	3.26184	0.34433	432	0.40242	0.22818
2015				119	3.35578	0.33977	109	1.25273	0.29908	370	1.55938	0.41883
2016	37	1.68080	0.65289	111	2.02925	0.29053	37	1.60227	0.42693	629	2.10454	0.15977
2017	38	0.64649	0.80277	99	1.49400	0.36124	92	0.86033	0.36111	585	1.50676	0.18838
2018	36	0.50953	0.81929	113	1.17880	0.33840	83	0.34283	0.55536	626	1.49763	0.20049
2019	34	0.93462	0.80558	101	0.53242	0.53561	88	0.77733	0.39848	727	1.13123	0.26553

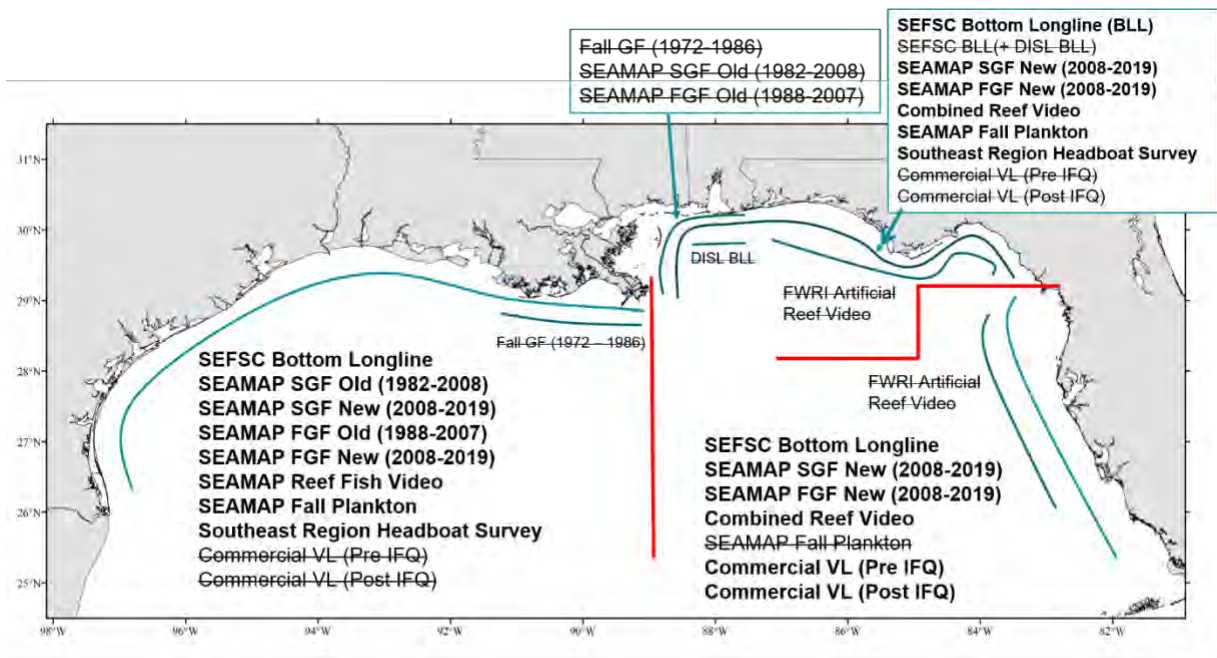
**Table 5.9.3 (continued).** Sampling effort (N), relative abundance (Index) scaled to a mean of one for each time series, and the coefficient of variation on the mean (CV, standard error/mean) of east Gulf of Mexico indices recommended for consideration in the assessment.

Year	Commercial VL Logbook (Pre IFQ)			Commercial VL Observer (Post IFQ)		
	N	Index	CV	N	Index	CV
1981						
1982						
1983						
1984						
1985						
1986						
1987						
1988						
1989						
1990						
1991						
1992						
1993	53	0.30000	0.22900			
1994	44	0.11300	0.30900			
1995	72	0.25100	0.20700			
1996	79	0.24200	0.18900			
1997	161	0.38200	0.17700			
1998	120	0.26400	0.21300			
1999	147	1.01600	0.17900			
2000	173	1.58700	0.13900			
2001	166	1.10200	0.16700			
2002	233	0.95200	0.16300			
2003	251	1.22000	0.13500			
2004	282	2.07300	0.12700			
2005	243	1.85700	0.13100			
2006	239	2.64100	0.11500			
2007				287	0.39728	0.14602
2008				310	0.47711	0.13951
2009				219	0.82190	0.14229
2010				496	0.83540	0.09916
2011				750	0.85067	0.07327
2012				1532	0.70204	0.05315
2013				660	0.74750	0.08099
2014				490	0.83747	0.11095
2015				853	0.90985	0.19003
2016				871	2.02687	0.08491
2017				457	1.49261	0.27869
2018				158	1.75158	0.14050
2019				81	1.14973	0.20411

5.10 FIGURES

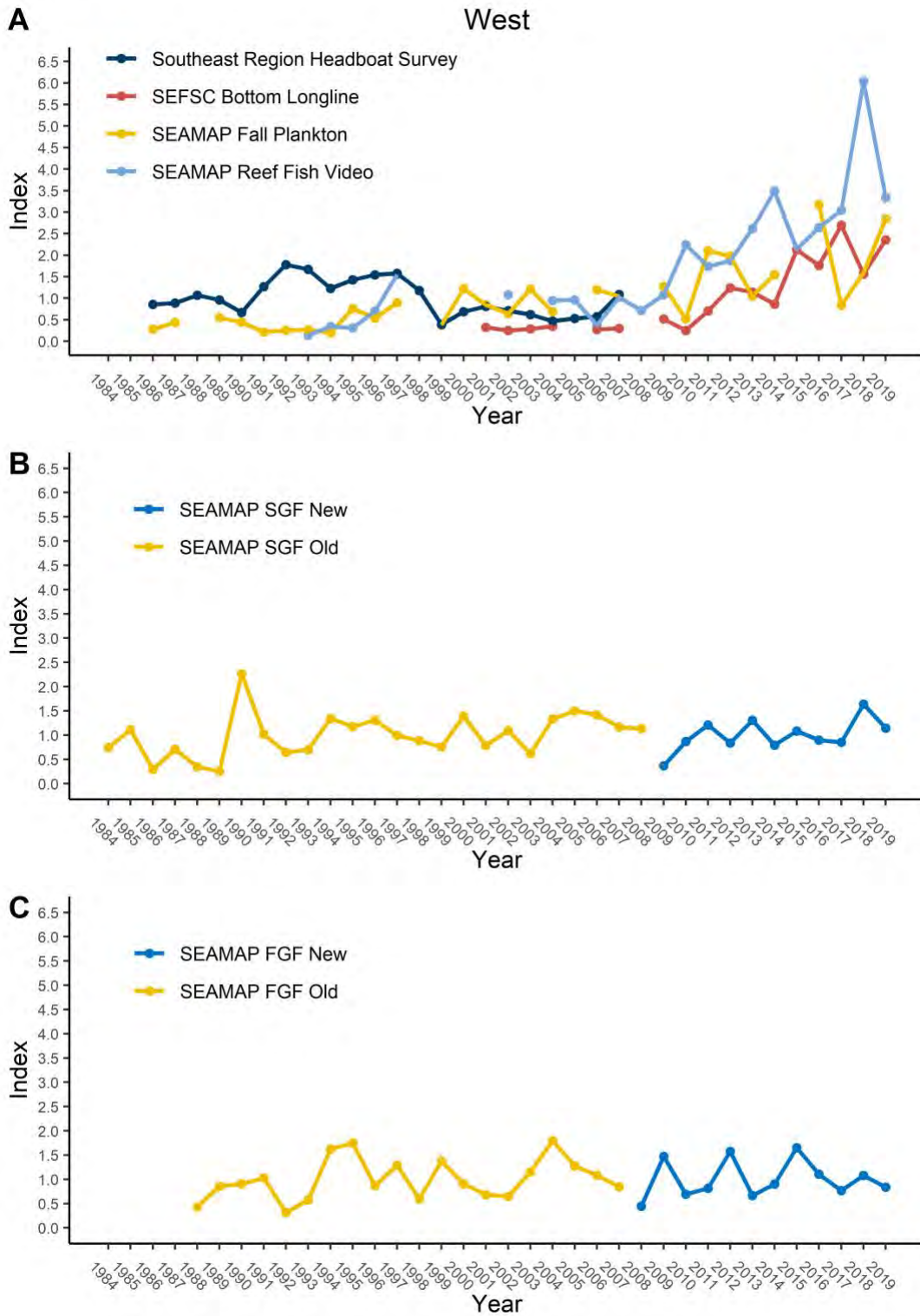


**Figure 5.10.1.** Relative spatial extent of indices found to be suitable for further review. Red lines represent the boundaries between the regions as defined at the SEDAR74 Stock ID Workshop.

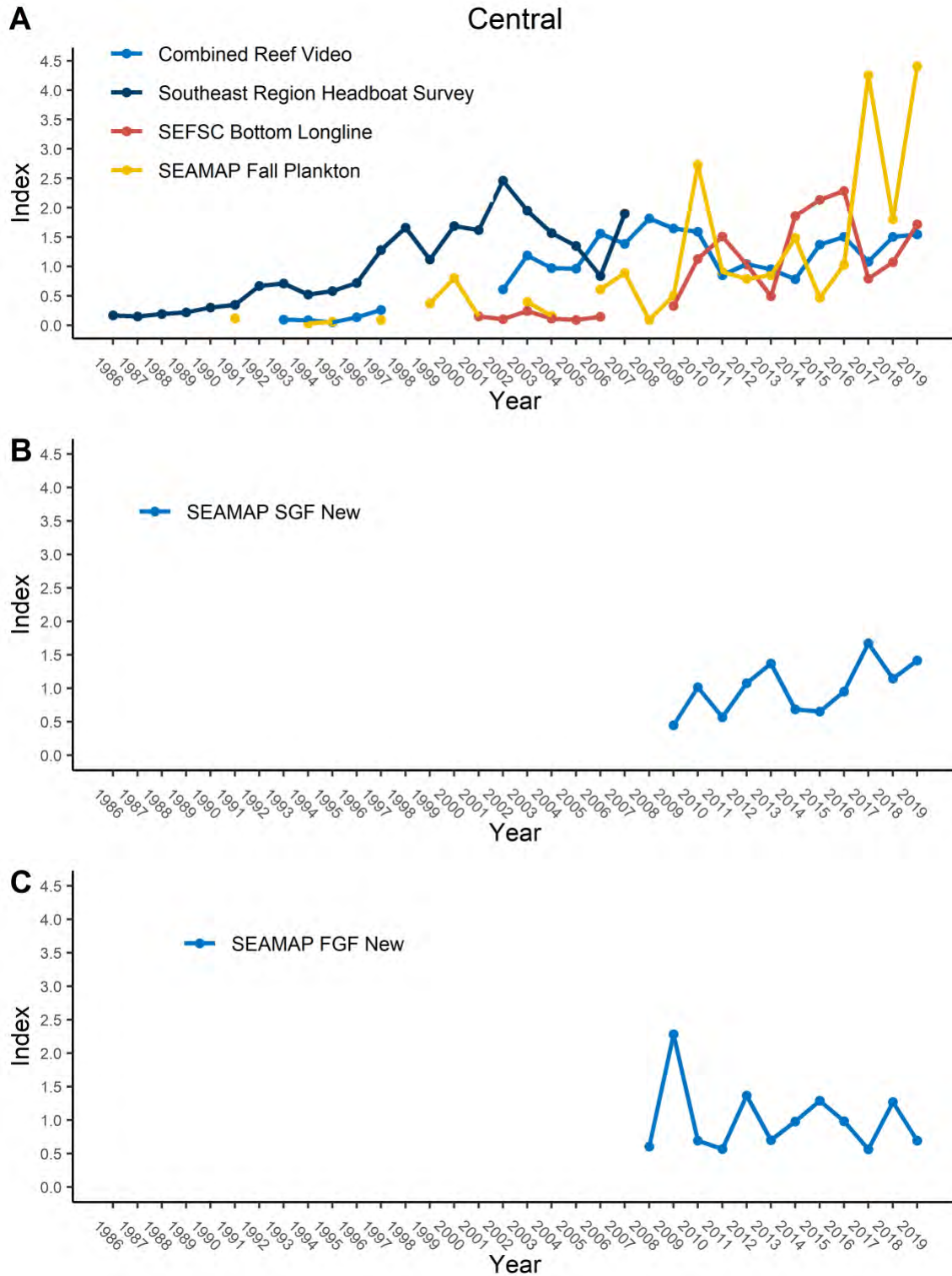


**Figure 5.10.2.** Relative spatial extent of indices found to be “Suitable and Recommended” for use in the assessment. Red lines represent the boundaries between the regions as defined at the SEDAR74 Stock ID Workshop.

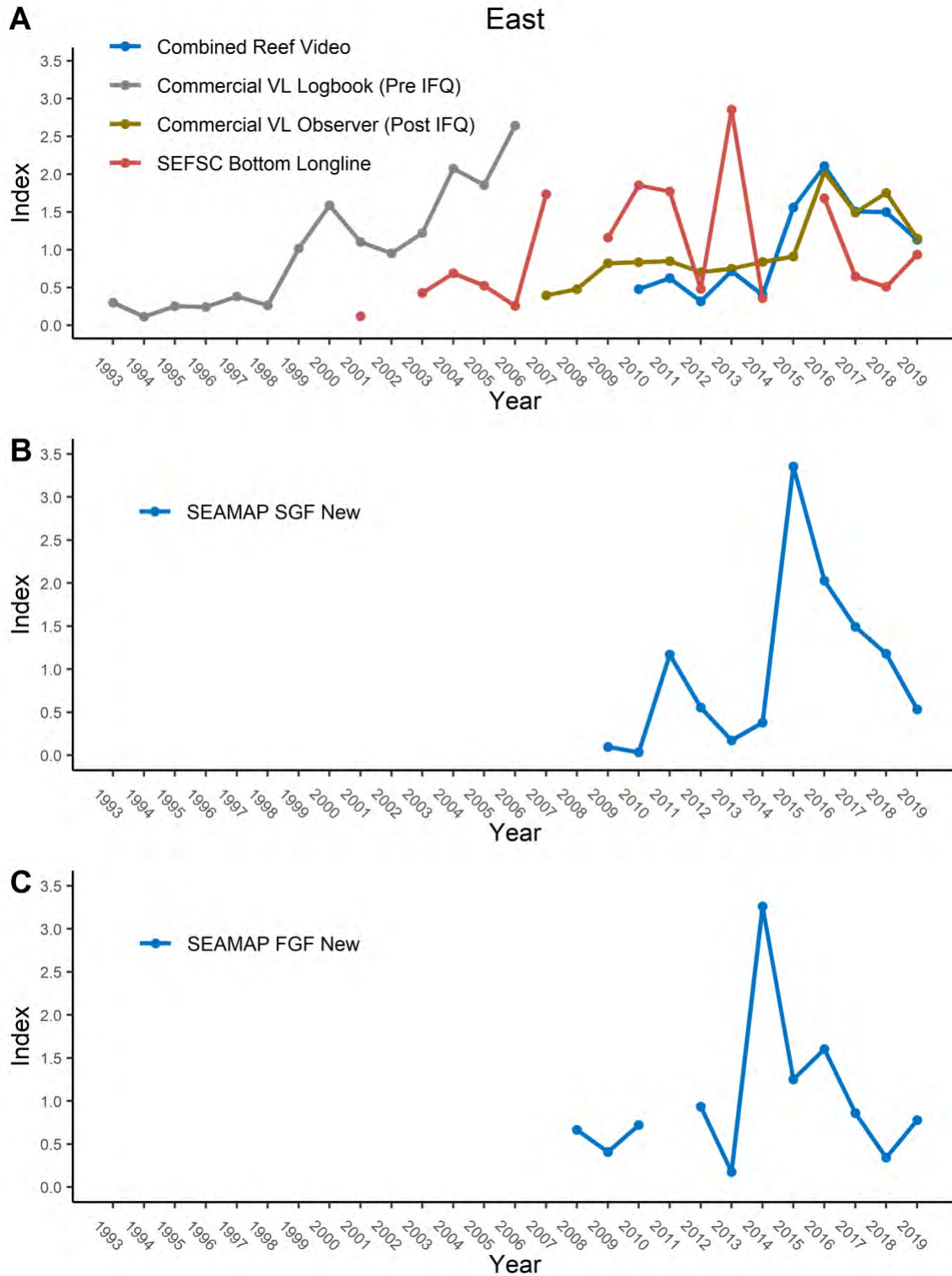




**Figure 5.10.3.** Recommended relative abundance indices for the west Gulf of Mexico, scaled to a mean of one for each time series. Panel A represents adult indices, panel B primarily age-1 recruits, and panel C primarily age-0 recruits.



**Figure 5.10.4.** Recommended relative abundance indices for the central Gulf of Mexico, scaled to a mean of one for each time series. Panel A represents adult indices, panel B primarily age-1 recruits, and panel C primarily age-0 recruits.



**Figure 5.10.5.** Recommended relative abundance indices for the east Gulf of Mexico scaled to a mean of one for each time series. Panel A represents adult indices, panel B primarily age-1 recruits, and panel C primarily age-0 recruits.



SEDAR

Southeast Data, Assessment, and Review

---

SEDAR 74

Gulf of Mexico Red Snapper

SECTION IV: Assessment Process Report

November 2023

SEDAR  
4055 Faber Place Drive, Suite 201  
North Charleston, SC 29405

*This information is distributed solely for the purpose of peer review. It does not represent and should not be construed to represent any agency determination or policy.*



# **SEDAR 74 Gulf of Mexico Red Snapper Assessment Report**

Gulf Branch  
Sustainable Fisheries Division  
NOAA Fisheries - Southeast Fisheries Science Center

November 21, 2023

## Table of Contents

1. Assessment Process Proceedings .....	5
1.1. Introduction .....	5
1.1.1. Workshop Time and Place.....	5
1.1.2. Terms of Reference .....	5
1.1.3. List of Participants.....	6
1.1.4. List of Assessment Process Working Papers and Reference Documents .....	7
2. Data Review and Update .....	7
2.1. Stock Structure and Management Unit.....	11
2.2. Life History Parameters.....	11
2.2.1. Meristics .....	11
2.2.2. Age and Growth .....	12
2.2.3. Natural Mortality .....	12
2.2.4. Maturity .....	12
2.2.5. Fecundity .....	13
2.3. Fishery-Dependent Data .....	13
2.3.1. Commercial Landings .....	13
2.3.2. Recreational Landings .....	14
2.3.3. Commercial Discards .....	15
2.3.4. Recreational Discards.....	15
2.3.5. Commercial Size Composition.....	16
2.3.6. Recreational Size Composition .....	16
2.3.7. Commercial Age Composition .....	16
2.3.8. Recreational Age Composition.....	17
2.3.9 Commercial Catch Per Unit of Effort Indices of Abundance.....	17
2.3.10. Recreational Catch Per Unit of Effort Indices of Abundance .....	17
2.3.11 Shrimp Trawl Bycatch.....	18
2.4. Fishery-Independent Surveys .....	18
2.4.1 SEAMAP Fall Plankton Survey .....	18
2.4.2. SEAMAP Trawl Survey .....	18
2.4.3. Video Surveys .....	19
2.4.4. NOAA NMFS Southeast Fisheries Science Center Bottom Longline Survey.....	19
2.4.5 Great Red Snapper Count (GRSC).....	20
2.5. Environmental Considerations & Contributions from Stakeholders.....	21

2.5.1 Connectivity Modeling System (CMS) Index .....	21
2.5.2 Other Environmental Considerations Reviewed But Not Incorporated .....	21
3. Stock Assessment Model Configuration and Methods .....	22
3.1. Stock Synthesis Model Configuration .....	22
3.1.1. Initial Conditions .....	23
3.1.2. Temporal Structure .....	23
3.1.3. Spatial Structure .....	23
3.1.4. Life History .....	24
3.1.5. Recruitment Dynamics .....	25
3.1.6. Fleet Structure and Surveys .....	25
3.1.7. Selectivity .....	27
3.1.8. Retention .....	30
3.1.9. Landings and Associated Length and Age Compositions .....	32
3.1.10. Discards .....	33
3.1.11. Indices .....	33
3.2. Goodness of Fit and Assumed Error Structure .....	33
3.3. Estimated Parameters .....	34
3.4. Diagnostics for Model Structure .....	34
3.4.1. Residual Analysis .....	35
3.4.2. Correlation Analysis .....	35
3.4.3. Sensitivity Runs .....	35
4. Stock Assessment Model - Results .....	36
4.1 Estimated Parameters .....	36
4.2 Fishing Mortality .....	36
4.3 Selectivity .....	37
4.3.1 Length-Based Selectivity .....	37
4.3.2 Age-Based Selectivity .....	38
4.4 Retention .....	39
4.5. Recruitment .....	39
4.6. Biomass and Abundance Trajectories .....	40
4.7. Model Fit and Residual Analysis .....	41
4.7.1. Landings .....	41
4.7.2. Discards .....	41
4.7.3. Indices .....	42

4.7.4 Shrimp Trawl Effort and Bycatch Data.....43

4.7.5. Length Compositions.....43

4.7.6. Age Compositions .....43

4.8. Model Diagnostics .....43

4.8.1. Correlation Analysis .....43

4.8.2. Sensitivity Model Runs .....44

5. Discussion.....44

6. Acknowledgements .....48

7. Research Recommendations.....49

8. References .....50

Tables .....52

Figures .....208



# 1. Assessment Process Proceedings

## 1.1. Introduction

SEDAR 74 addressed the stock assessment for Gulf of Mexico Red Snapper using data inputs through 2019 as implemented in the Stock Synthesis 3 modeling framework (Methot and Wetzel 2013).

### 1.1.1. Workshop Time and Place

The SEDAR 74 Assessment Process for Gulf of Mexico Red Snapper was conducted via a series of webinars held between October 2022 and July 2023.

### 1.1.2. Terms of Reference

The terms of reference approved by the Gulf of Mexico Fishery Management Council (GMFMC) are listed below.

1. Review any changes in data or analyses following the Data Workshop. Summarize data as used in each assessment model. Provide justification for any deviations from Data Workshop recommendations.
2. Develop population assessment model(s) that are appropriate for the available data
  - a. Consider and incorporate as appropriate the information derived from the “Great Red Snapper Count” and other independent studies.
  - b. Evaluate selectivity and retention functions for all directed, discard, and bycatch fleets as appropriate.
  - c. Consider incorporating the Connectivity Modeling Simulation recruitment index to inform trends in recruitment for forecasting.
  - d. Investigate fitting length composition data directly within the SS3 model as opposed to developing age-length keys and converting length frequency to age composition external to the modeling process.
  - e. Explore whether available data supports the estimation of growth parameters within the model.
  - f. Explore whether alternate recreational fleet structures are supported in the assessment model. Specifically, determine whether selectivity functions are estimable and model stability is maintained.
3. Provide estimates of stock population parameters, including:
  - a. Fishing mortality, abundance, biomass, selectivity, stock-recruitment relationship, sex ratio, and other parameters as necessary to describe the population.
4. Characterize uncertainty in the assessment and estimated values.
  - a. Consider uncertainty in input data, modeling approach, and model configuration.
  - b. Provide appropriate measures of model performance, reliability, and ‘goodness of fit’.

- c. Provide measures of uncertainty for estimated parameters.
- 5. Provide recommendations for future research and data collection. Emphasize items that will improve future assessment capabilities and reliability. Consider data, monitoring, and assessment needs.
- 6. Complete an Assessment Workshop Report in accordance with project schedule deadlines.

### 1.1.3. List of Participants

#### *Assessment Development Team*

LaTreese Denson, Co-Lead Analyst.....	SEFSC/NMFS
Matt Smith, Co-Lead Analyst.....	SEFSC/NMFS
Luiz Barbieri.....	GMFMC SSC/FWRI
David Chagaris .....	GMFMC SSC/UFL
Paul Mickle.....	GMFMC SSC/MS State
Will Patterson .....	GMFMC SSC/UFL
Katie Siegfried.....	SEFSC/NMFS
Jim Tolan.....	GMFMC SSC/TPWD

#### *Assessment Process Observers*

Kelly Adler .....	SEFSC/NMFS
Jason Adriance.....	LDWF
Katline Barrows.....	
Kristan Blackhart.....	NOAA
Harry Blanchet.....	LADWF
Ellie Corbett.....	FWC
David Die.....	UM
Michael Drexler.....	Ocean Conservancy
Francesca Forrestal.....	NMFS Miami
Carissa Gervasi.....	UM/CIMAS
Bob Gill .....	
Buddy Guindon .....	Katie’s Seafood
Martha Guyas .....	ASA
David Hanisko .....	NMFS Pascagoula
Mandy Karnauskas .....	NMFS Miami
Rich Malinowski .....	NOAA
John Mareska.....	AL DCNR
Johnny Marquez .....	MS Wildlife Fed
Craig Newton.....	ADCNR/MRD
Adam Pollack .....	NMFS Pascagoula
Kellie Ralston .....	Bonefish & Tarpon Trust
Ashford Rosenberg.....	Shareholders Alliance
Skyler Sagarese .....	SEFSC/NMFS
Beverly Sauls.....	FWC-FWRI
Eric Schmidt .....	Charter Captain

Molly Stevens ..... SEFSC/NMFS  
 Ana Vaz ..... NOAA

**Staff**

Julie Neer ..... SEDAR  
 Judd Curtis ..... SAFMC Staff  
 John Froeschke ..... GMFMC Staff  
 Michael Larkin ..... NMFS/SERO  
 Ryan Rindone ..... GMFMC Staff  
 Carrie Simmons ..... GMFMC Staff  
 Carly Somerset ..... GMFMC Staff

**1.1.4. List of Assessment Process Working Papers and Reference Documents**

Document #	Title	Authors	Date Submitted
<b>Documents Prepared for the Assessment Process</b>			
SEDAR74-AP-01	A meta-analysis of red snapper ( <i>Lutjanus campechanus</i> ) discard mortality in the Gulf of Mexico	Chloe Ramsay, Julie Vecchio, Dominique Lazarre, Beverly Sauls	16 November 2022
SEDAR74-AP-02	Final Report of the SEDAR 74 Ad-hoc Discard Mortality Working Group for Gulf of Mexico Red Snapper ( <i>Lutjanus campechanus</i> )	SEDAR 74 Discard Mortality Ad-Hoc Working Group	16 February 2023
<b>Reference Documents</b>			
SEDAR74-RD115	Relative Effects of Multiple Stressors on Reef Food Webs in the Northern Gulf of Mexico Revealed via Ecosystem Modeling	David D. Chagaris, William F. Patterson III and Michael S. Allen	

**2. Data Review and Update**

The Gulf of Mexico (GOM) Red Snapper Research Track assessment required all available and relevant data to be prepared for assessment following the recommended three-area stock structure approved through the stock ID workshop. This process was accomplished through a series of data-focused webinars and a dedicated in person Data Workshop. Per the terms of reference for the Research Track Assessment, all sources of data were evaluated, prepared

following current best practices, and representative of the spatial and temporal bounds of the assessment. The majority of the data included in the previously approved Red Snapper stock assessment model were used in SEDAR 74. However, changes to the stock ID and efforts to eliminate redundancies, particularly among indexes of abundance, resulted in the elimination of some previously approved data while several new sources were recommended for inclusion.

Notable new or significantly adjusted sources of data include: an estimate of absolute abundance produced through a research project entitled “Estimating the Absolute Abundance of Age-2+ Red Snapper (*Lutjanus campechanus*) in the U.S. Gulf of Mexico” (Stunz et al., 2021) and commonly referred to as the Great Red Snapper Count (GRSC); the National Marine Fisheries Service’s (NMFS) Marine Recreational Information Program (MRIP) Fishing Effort Survey (FES) catch and discard time series; and, spatially and temporally explicit estimates of maturity and fecundity parameters. The complete data utilized in the SEDAR 74 base model are summarized below and illustrated in **Figure 1** along with their corresponding temporal scale. Data details are included in referenced working papers.

1. Life history
  - a. Meristics
  - b. Age and growth
  - c. Natural mortality
  - d. Maturity
  - e. Fecundity
2. Landings
  - a. Commercial Handline West: 1950-2019 (metric tons whole weight)
  - b. Commercial Handline Central: 1950-2019 (metric tons whole weight)
  - c. Commercial Handline East: 1950-2019 (metric tons whole weight)
  - d. Commercial Longline West: 1980-2019 (metric tons whole weight)
  - e. Commercial Longline Central: 1980-2019 (metric tons whole weight)
  - f. Commercial Longline East: 1980-2019 (metric tons whole weight)
  - g. Recreational Charter West: 1955-2019 (thousands of fish)
  - h. Recreational Charter Central: 1955-2019 (thousands of fish)
  - i. Recreational Charter East: 1955-2019 (thousands of fish)
  - j. Recreational Headboat West: 1955-2019 (thousands of fish)
  - k. Recreational Headboat Central: 1955-2019 (thousands of fish)
  - l. Recreational Headboat East: 1955-2019 (thousands of fish)
  - m. Recreational Private West: 1955-2019 (thousands of fish)
  - n. Recreational Private Central: 1955-2019 (thousands of fish)
  - o. Recreational Private East: 1955-2019 (thousands of fish)
3. Discards
  - a. Commercial Handline West: 1995-2019 (metric tons whole weight)
  - b. Commercial Handline Closed Season Discards West: 1995-2006 (metric tons whole weight)
  - c. Commercial Handline Central: 1995-2019 (metric tons whole weight)

- d. Commercial Handline Closed Season Discards Central: 1995-2006 (metric tons whole weight)
  - e. Commercial Handline East: 1995-2019 (metric tons whole weight)
  - f. Commercial Handline Closed Season Discards East: 1995-2006 (metric tons whole weight)
  - g. Commercial Longline West: 1995-2019 (metric tons whole weight)
  - h. Commercial Longline Closed Season Discards West: 1995-2006 (metric tons whole weight)
  - i. Commercial Longline Central: 1995-2019 (metric tons whole weight)
  - j. Commercial Longline Closed Season Discards Central: 1995-2006 (metric tons whole weight)
  - k. Commercial Longline East: 1995-2019 (metric tons whole weight)
  - l. Commercial Longline Closed Season Discards East: 1995-2006 (metric tons whole weight)
  - m. Recreational Charter West: 1982-2019 (thousands of fish)
  - n. Recreational Charter Closed Season Discards West: 1997-2019 (thousands of fish)
  - o. Recreational Charter Central: 1981-2019 (thousands of fish)
  - p. Recreational Charter Closed Season Discards Central: 1997-2019 (thousands of fish)
  - q. Recreational Charter East: 1982-2019 (thousands of fish)
  - r. Recreational Charter Closed Season Discards East: 1997-2019 (thousands of fish)
  - s. Recreational Headboat West: 1982-2019 (thousands of fish)
  - t. Recreational Headboat Central: 1981-2019 (thousands of fish)
  - u. Recreational Headboat East: 1982-2019 (thousands of fish)
  - v. Recreational Private West: 1981-2019 (thousands of fish)
  - w. Recreational Private Closed Season Discards West: 1997-2016 (thousands of fish)
  - x. Recreational Private Central: 1981-2019 (thousands of fish)
  - y. Recreational Private Closed Season Discards Central: 1997-2019 (thousands of fish)
  - z. Recreational Private East: 1981-2019 (thousands of fish)
  - aa. Recreational Private Closed Season Discards East: 1998-2019 (thousands of fish)
  - bb. Shrimp Trawl West: 1950-2019 (metric tons whole weight)
  - cc. Shrimp Trawl Central: 1950-2019 (metric tons whole weight)
  - dd. Shrimp Trawl East: 1950-2019 (metric tons whole weight)
4. Length composition of landings
- a. Commercial Handline West: 1984-2019
  - b. Commercial Handline Central: 1984-2019
  - c. Commercial Handline East: 1984-2019
  - d. Commercial Longline West: 1984-2019
  - e. Commercial Longline Central: 2018-2018
  - f. Commercial Longline East: 1984-2019

- g. Recreational Charter West: 1983-2019
  - h. Recreational Charter Central: 1981-2019
  - i. Recreational Charter East: 2002-2019
  - j. Recreational Headboat West: 1982-2019
  - k. Recreational Headboat Central: 1981-2019
  - l. Recreational Headboat East: 1983-2019
  - m. Recreational Private West: 1982-2019
  - n. Recreational Private Central: 1981-2019
  - o. Recreational Private East: 2008-2019
  - p. Commercial Observer Program East: 2007-2019
5. Abundance indices
- a. Fishery-independent:
    - i. Bottom Longline West: 2001-2019
    - ii. Bottom Longline Central: 2001-2019
    - iii. Bottom Longline East: 2001-2019
    - iv. SEAMAP Fall Trawl Pre-2007 West: 1988-2007
    - v. SEAMAP Fall Trawl Post-2007 West: 2008-2019
    - vi. SEAMAP Fall Trawl Post-2007 Central: 2008-2019
    - vii. SEAMAP Fall Trawl Post-2007 East: 2008-2019
    - viii. SEAMAP Reef Fish Video Survey West: 1993-2019
    - ix. Combined Video Survey Central: 1993-2019
    - x. Combined Video Survey East: 2010-2019
    - xi. SEAMAP Larval Survey West: 1986-2019
    - xii. SEAMAP Larval Survey Central: 1991-2019
    - xiii. SEAMAP Summer Trawl Pre-2007 West: 1984-2008
    - xiv. SEAMAP Summer Trawl Post-2007 West: 2009-2019
    - xv. SEAMAP Summer Trawl Post-2007 Central: 2009-2019
    - xvi. SEAMAP Summer Trawl Post-2007 East: 2009-2019
    - xvii. Red Snapper Count West: 2018
    - xviii. Red Snapper Count Central: 2018
    - xix. Red Snapper Count East: 2018
  - b. Fishery-dependent:
    - i. Shrimp Trawl West: 1950-2019 (effort as a “survey” of  $F$  to scale annual discards for the Shrimp Trawl West fleet)
    - ii. Shrimp Trawl Central: 1950-2019 (effort as a “survey” of  $F$  to scale annual discards for the Shrimp Trawl Central fleet)
    - iii. Shrimp Trawl East: 1950-2019 (effort as a “survey” of  $F$  to scale annual discards for the Shrimp Trawl East fleet)
    - iv. Commercial Handline East: 1993-2006
    - v. Commercial Observer Program East: 2007-2019
6. Length composition of surveys:
- b. SEAMAP Fall Trawl Pre-2007 West: 1988-2007

- c. SEAMAP Reef Fish Video Survey West: 1996-2019
  - d. Combined Video Survey Central: 2002-2019
  - e. Combined Video Survey East: 2010-2019
  - f. SEAMAP Summer Trawl Pre-2007 West: 1987-2008
  - g. SEAMAP Summer Trawl Post-2007 West: 2009-2019
  - h. SEAMAP Summer Trawl Post-2007 Central: 2009-2019
  - i. SEAMAP Summer Trawl Post-2007 East: 2015-2018
7. Age composition of surveys:
- a. Bottom Longline West: 2001-2019
  - b. Bottom Longline Central: 2001-2019
  - c. Bottom Longline East: 2001-2019
  - d. SEAMAP Fall Trawl Post-2007 West: 2008-2019
  - e. SEAMAP Fall Trawl Post-2007 Central: 2008-2019
  - f. SEAMAP Fall Trawl Post-2007 East: 2008-2019

## 2.1. Stock Structure and Management Unit

The management unit for GOM Red Snapper extends from the United States–Mexico border in the west through the northern GOM waters and west of the Dry Tortugas and the Florida Keys (waters within the GOM Fishery Management Council boundaries). Based on the recommendations of the Stock ID Working Group, SEDAR 74 assumed there are three primary sub-stocks of Red Snapper within this region. Roughly, the western area comprised the waters between the U.S.–Mexico border and the Mississippi River outflow, the central area included the waters offshore from Mississippi, Alabama, and the panhandle of Florida, while the eastern area included the central and southern portions of the west Florida shelf. Currently, the Council manages the two Red Snapper sub-stocks (east and west) as one unit, but the option to utilize the new eastern, central, and western management units remains viable. For practical purposes, the east, central and west GOM assessment areas were defined based on GOM shrimp grids (grids 1 to 6 for the east GOM, 7 through 12 for the central GOM, and 13 to 21 for the west GOM). The areas are illustrated in **Figure 2** with further details available in the SEDAR 74 Stock ID Process Final Report (SEDAR 2021).

## 2.2. Life History Parameters

Life history data used in the assessment included length-length and length-weight relationships, age and growth, natural mortality, and reproduction data. All life history data incorporated into the population model (Stock Synthesis) were input as fixed parameters estimated external to the population model.

### 2.2.1. Meristics

All length-length and length-weight relationships ( $W = aFL^b$ ) were developed using updated combined sex data and presented at the SEDAR 74 Data Workshop. Length-weight relationships did not vary by area and were incorporated as fixed model inputs (See Table 9 in SEDAR (2022)).

### 2.2.2. Age and Growth

Paired length and age data through 2019 were used to estimate spatially and temporally varying growth curves by the Life History Working Group during the Data Workshop. In all cases, size-adjusted von Bertalanffy growth models were fit to inverse weighted data (i.e.,  $1/\text{age-specific } n$ ) because they provided improved fits to older age classes which had substantially smaller sample sizes than younger age classes. Growth parameters were estimated independently by assessment area and by time-stanza (1991-2008, 2009-2015, and 2016-2019) which were based on trends in biomass that were loosely interpreted as depleted, rebuilding, and asymptotic recovery. Temporal differences were non-significant, so the final analysis was restricted to estimating spatially varying growth curves. Area-specific growth parameters were estimated externally to Stock Synthesis for both sexes combined, and fixed within the model (See Section 2 of SEDAR (2022) for additional details) (**Figure 3**).

Ageing error estimates were provided during the Data Workshop. Estimates were developed using several different scenarios to model bias and precision for the primary reader, using the Northwest Fisheries Science Center's ageing error (`nwfscAgeingError`) package in R (Punt et al. 2008, Thorson et al. 2012). Ageing error models were not estimated separately for each subregion because there is no evidence to suggest a difference in readability among regions. The selected ageing error model included linear bias and curvilinear standard deviation. Age-specific pairwise comparisons indicated significant differences between expert and primary reader mean age estimates for ages 2, 3, 5-8, and 10, but mean ages between readers only differed by 0.02 to 0.31 years. Significant differences were likely due to large sample sizes within these age classes. The resulting ageing error matrix used in the SEDAR 74 base model is shown in **Figure 4** (further details provided in SEDAR74-DW-34).

### 2.2.3. Natural Mortality

An age-specific vector of natural mortality ( $M$ ) was estimated during the SEDAR 74 Data Workshop. Review of available age data indicated a maximum validated age of 57 years for GOM Red Snapper. Natural mortality rate was estimated using the method of Then et al. (2015) with the Lutjanid-specific parameter subset and the resulting estimate was used to scale the Lorenzen age-specific natural mortality function (Lorenzen 2000). Following previous Red Snapper assessment recommendations, the natural mortality for age-0 and age-1 were fixed at 2.0 and  $1.2 \text{ y}^{-1}$ , respectively (see section 2.5 of SEDAR (2022) for additional details). Natural mortality vectors were assumed to be spatially and temporally constant and fixed in the model (**Table 1, Figure 3**).

### 2.2.4. Maturity

Spatially and temporally specific maturity relationships were estimated by the Life History Working Group during the Data Workshop (See Section 2 of SEDAR (2022) for additional details). Due to sample size limitations spatial estimates were limited to a western GOM estimate and an eastern GOM estimate which used combined samples from the central and east assessment areas. Temporal periods were specified as 1991-2008, 2009-2015, and 2016-2019 which were based on trends in biomass that were loosely interpreted as depleted, rebuilding, and asymptotic recovery. Estimates of age and length at 50% maturity varied by area and time. Results from the preferred random effects model indicated that Red Snapper in the west matured



at an older age for a given time period (1.52, 1.71, and 2.46 years) than those in the east (1.36, 1.44, and 1.93 years) (See Table 5 in SEDAR (2022)). Conversely, the length at 50% maturity was uniformly smaller for a given time-period in the west (22.0, 23.8, and 31.5 cm) than in the east (25.6, 28.0, 32.8 cm) (See Table 6 in SEDAR (2022)). Age-based maturity curves were selected for use in the population model. The Life History Working Group recommended incorporating the time-varying aspects of maturity into the population model. However, attempts to do so resulted in enough computational instability that the Assessment Development Team determined it would be more appropriate to use time invariant estimates in the final model. Follow-up analysis (Claudia Friess, personal communication) produced spatially-specific, time-invariant age at 50% maturity and slope estimates that were input as fixed parameters with the central and east assessment areas both using the eastern GOM estimates (**Table 2**). Sex ratio at birth was assumed to be 50% female and 50% male.

### 2.2.5. Fecundity

Batch fecundity at age and length estimates were produced following the same spatial and temporal structure as the maturity estimates. Estimates, though highly uncertain, indicated that fecundity had a decreasing trend with time for a given area and was generally greater in the eastern area than in the west (See Section 2 of SEDAR (2022) for additional details). The Life History Working Group recommended using weight (Spawning Stock Biomass) as a proxy for fecundity, as the high level of uncertainty around the fecundity estimates, particularly for older fish (age-10+), caused the group to doubt the reliability of the estimates for use in the assessment.

## 2.3. Fishery-Dependent Data

### 2.3.1. Commercial Landings

Commercial landings and their corresponding estimates of uncertainty are presented in the SEDAR 74 GOM Red Snapper Data Workshop report (SEDAR 2022, Table 3.1 and Table 3.7). The primary commercial gears used for GOM Red Snapper are the Handline (vertical lines, bandit rigs, rod and reel, etc.) and Longline. Handline landings estimates were provided back to 1872; however, the historic estimates (prior to 1950) were not directly included in the final model because they were highly uncertain due to poor historic record keeping and uncertainty around assigning them into the new three-area model structure. For each assessment area, a Handline fleet (1950-2019) and a Longline fleet (1980-2019) were included in the model (**Figure 5**). Commercial landings were reported in pounds and converted to metric tons for input to the assessment model. The model was unable to converge when the Data Workshop recommended CVs were used for all years of the commercial data. Exploratory runs indicated that sufficient model stability was achieved if landings prior to 1995 were input as essentially known without error (CV 0.05). All other years (1995-2019) made use of the Data Workshop recommended CVs (see Table 3.7 in SEDAR (2022) for recommended CVs).

A large amount of commercial fishing occurred prior to the 1950 model start year, and as such the population for all assessment areas could not be assumed to be at or near unfished conditions at the start of the model. Therefore, area and fleet specific initial fishing mortality estimates ( $F$ ) were required for all fleets thought to be operating prior to 1950. For the commercial fleets this was limited to the Handline fleets for each area as no Longline landings were recorded prior to

1980. Initial equilibrium catches were calculated for the Handline fleet as the average landings over the first twenty years of historic landings (1930-1949). CVs of 0.01 were used to force the model to fit the initial catch values and the resulting estimates of  $F$  were applied prior to the model start year to adjust the area-specific initial population structures.

### 2.3.2. Recreational Landings

Recreational landings data (1955-2019) used in the assessment are presented in (SEDAR 2022, Tables 4.12.4 and 4.12.15). For the data period (1981-2019), final recreational landings were computed using fully calibrated estimates from the MRIP using FES, the Southeast Region Headboat Survey (SRHS), Louisiana Creel, and the Texas Parks and Wildlife Department (TPWD) data (see SEDAR74-WP-01). Recreational landings are reported by mode and include data on the Charter Boat, Headboat, and Private fleets. For the assessment, each recreational mode was modeled separately for each assessment area. Recreational Private landings represented the dominant mode in the total recreational landings by numbers since 1981. Recreational landings were reported in numbers of fish and input into the assessment model as 1000s of fish (**Figure 6**).

Historical estimates (1955-1980) for recreational landings were estimated using the National Survey of Fishing, Hunting, & Wildlife-Associated Recreation (FHWAR) method (For a recent document detailing the methodology, see SEDAR72-WP-05). The FHWAR method utilizes a combination of information including U.S. angler population estimates and angling effort estimates from 1955-1985 to estimate effort (saltwater days) for the GOM for every five years when the survey is conducted. For the years in between, a linear interpolation of the estimates is applied. Estimates of effort for 1955-1980 are then multiplied by the mean catch per unit effort (CPUE) for GOM Red Snapper for 1981 to 1989 (MRIP, SRHS and TPWD combined) to estimate annual landings for the historical time period (1945-1980). For SEDAR 74, total historical recreational catches were apportioned by mode and stock assessment area using fleet- and area-specific mean ratios of recreational landings from 1981-1989. Lastly, the area-specific ratios of For-Hire landings: Recreational Private landings were adjusted back in time to account for a historically less robust Recreational Private angling fleet due to technological and accessibility limitations (see SEDAR (2022) for a complete description).

Uncertainty estimates were provided for the recreational fleet landings for 1981-2019 (SEDAR74-WP-01 or SEDAR 2022, Table 4.12.6). Attempts to directly use the Data Workshop supplied estimates of CV resulted in unacceptable levels of model instability. Consequently, workshop supplied CVs were used from 1995-2019 and earlier landings (1955-1994) had CVs fixed at 0.15 which was the value applied to all years of recreational landings in the most recently completed Red Snapper assessment (see Table 4.12.4-4.12.8 in SEDAR (2022) for recommended CVs).

Starting the assessment model in 1950, when the stock was already in a fished state, requires the estimation of initial conditions via initial equilibrium catches, which are used to calculate initial fishing mortality rates. Initial equilibrium catches were set equal to the reported landings in 1955. Furthermore, the years 1950-1954, for which no landings were reported, also had catch values set equal to the fleet and area-specific 1955 landings. These additional years of landings were required to allow Stock Synthesis (SS) to estimate an initial catch without assuming zero landings in the years between the model start year and the first data year. Initial equilibrium

catch was set for all recreational fleets with the exception of the east area Headboat fleet. This fleet was excluded because it reported near zero landings in 1955.

### 2.3.3. Commercial Discards

Commercial discards used in SEDAR 74 are presented in SEDAR (2022), Tables 3.4.1.1. - 3.4.1.2. The commercial discards for GOM Red Snapper were estimated using two methodologies to accommodate differing levels of data quality and availability. Discards occurring between 1995 and 2006 were estimated separately for periods when the fishery was open and closed using methods developed during SEDAR 32 (McCarthy 2015, 2013). This approach, which makes use of commercial discard logbook data, has become standard practice for estimating commercial discards in the absence of observer data. Details on the approach are provided in the SEDAR 74 Data Workshop report (SEDAR 2022). Discards occurring after 2006 are estimated using an improved methodology which made use of CPUE from the Commercial Reef Fish Observer Program and total fishing effort from the Commercial Reef Fish Logbook Program to estimate total catch (SEDAR74-DW-19). Discards occurring after 2006 were assumed to all happen during an “open season” because the commercial fleets were allocated individual fishing quota which effectively extended the season year-round. For both methodologies, discard estimates were reported in numbers and were input into the assessment as 1,000s of fish (trends shown in **Figure 7** and proportions by fleet shown in **Figure 8**) with corresponding log-scale standard errors fixed at values provided (SEDAR 2022, Table 3.4.2.1). Area and fleet-specific discard mortality rates were provided in SEDAR 74-AP-02 (SEDAR 2023). Commercial discard mortality rates were estimated as the midpoint between the percent of Red Snapper reported discard dead and the percent of Red Snapper reported discarded dead plus those discarded with indications of barotrauma. Sample size limitations prevented the estimation of separate open and closed season discard mortality rates for the commercial fleets.

### 2.3.4. Recreational Discards

Recreational discard estimates used in the assessment were provided for all fleets during 1981-2019 and are presented in SEDAR (2022) Tables 4.12.11-4.12.13. When the data allowed, recreational discards were divided into those occurring when the fishing season was open and those occurring when the fishing season was closed (open and closed season, respectively). Open and closed season discards were tabulated for the Recreational Private and Charter Boat fleets for all areas, while the Headboat fleet, for all areas, had only combined discards treated as having occurred in an open season. Methodology for seasonal division of discards is discussed in SEDAR74-DW-35.

Recreational discards were reported as numbers of fish and input into the assessment as 1000s of fish (**Figure 9**) with Data Workshop supplied annual estimates of standard error (SEDAR 2022, Tables 4.12.11-4.12.13). Recreational discard mortality rates were estimated using the previously approved meta-analysis approach of Campbell et al. (2014) with updated data sets that accounted for depth of capture, assessment area of capture, season of release, and presence of venting/descending equipment. Detailed methodological description of area and fleet-specific recreational discard mortality rates were provided in SEDAR 74-AP-02 (SEDAR 2023). Where possible, separate open and closed season discard mortality rates were estimated. However, in many cases sample sizes were insufficient to support separate season-based estimates resulting in a single combined estimate.

### **2.3.5. Commercial Size Composition**

Commercial Handline and Longline length compositions of landed (retained) fish are discussed in the SEDAR 74-DW-15 working paper. The annual length compositions were combined into 5-cm fork length interval bins (10 - 115). Length compositions of landings were constructed using data from the Commercial Trip Intercept Program (TIP) and GulfFIN and were processed following the procedures detailed in the SEDAR74-DW-15 working paper. For SEDAR 74 nominal length compositions were provided for the commercial fleets and not weighted by landings as is typically the case. Nominal length compositions were provided as they were deemed sufficient for model development as the intent of this assessment was not to estimate stock status or directly inform management. Weighted compositions will be requested for future Operational Track Assessments. The input sample sizes were simply the number of trips sampled for that year/fleet. Year/fleet combinations with less than 10 trips sampled were removed from the assessment model.

Data from the Commercial Reef Fish Observer Program were used to compile nominal length compositions for commercial discards occurring between 2007 and 2019 (SEDAR74-DW-38).

### **2.3.6. Recreational Size Composition**

The Recreational Charter Boat, Southeast Regional Headboat Survey (Headboat), and Private sector length compositions of landed fish are discussed in SEDAR74-DW-15. The annual length compositions were combined into 5-cm fork length interval bins (10:115). Length compositions of landings were constructed using the MRFSS/MRIP, SRHS, TPWD, the GulfFIN database, and the TIP database. Nominal compositions were provided for the Research Track Assessment as they were deemed sufficient for model development as the intent of this assessment was not to estimate stock status or directly inform management. Weighted compositions will be requested for future Operational Track Assessments. A description of the revised methods used to develop the length composition data was provided in SEDAR74-DW-15. The input sample size associated with each year/fleet were provided in numbers of fish and trips, with trips used as sample sizes in the assessment model. Year/fleet combinations with less than 10 trips sampled were removed from the assessment model.

Data from the Florida Fish and Wildlife Commission (FWC) Fish and Wildlife Research Institute (FWRI) At-Sea Observer Program (2006-2019) were used to characterize the length compositions from recreational discards (SEDAR 74-DW-18). However, spatial limitations of the sampling and insufficient sample sizes prevented the data from being incorporated in SEDAR 74.

### **2.3.7. Commercial Age Composition**

A detailed description of the commercial age compositions of landed fish were provided in SEDAR74-DW-15. Nominal age compositions for all year/fleet combinations were available; however, age composition data for the commercial fleets was not incorporated into the final assessment model since the fleet selectivities were modeled with length composition data. Models using age composition for the commercial fleets were developed as part of the Research Track Assessment but ultimately rejected in favor of the length-based models. Length-based

models were ultimately preferred because they had reduced residual patterns in the fits to the composition data and generally improved fits to landings and discards.

### 2.3.8. Recreational Age Composition

A detailed description of the recreational age compositions of landed fish were provided in SEDAR74-DW-15. Nominal age compositions for all year/fleet combinations were available; however, age composition data for the recreational fleets was not incorporated into the final assessment model since the fleet selectivities were modeled with length composition data. Models using age composition for the recreational fleets were developed as part of the Research Track Assessment but ultimately rejected in favor of the length-based models. Length-based models were ultimately preferred because they greatly reduced residual patterns in the fits to the composition data and generally improved fits to landings and discards.

### 2.3.9 Commercial Catch Per Unit of Effort Indices of Abundance

Standardized catch per unit effort (CPUE) indices based on the Commercial Handline data (SEDAR 74-DW-17) and the Commercial Reef Fish Observer data (SEDAR 74-DW-38) were produced for the assessment. The Index Working Group at the Data Workshop recommended that the Handline east index (1993-2006) and the Commercial Reef Fish Observer Program east index (2007-2019) be included in the assessment (SEDAR 2022, Section 5) (**Table 3**). Annual CVs were scaled to a common mean CV of 0.2 (Francis et al. 2003) and converted to log-scale SEs for input in Stock Synthesis (**Table 4**), maintaining relative annual variation. Scaling CVs to a common mean was used in the previous Red Snapper assessment because indices are standardized using different techniques and the output SEs are not directly comparable, nor do they adequately characterize the relative confidence in the various indices. Scaling each index to a common mean allows them to be equally weighted within the assessment.

Length composition data were provided for the Commercial Reef Fish Observer data and were input as nominal composition with sample sizes equal to number of fish. The Commercial Handline index for the east area utilized the landed length composition for the eastern Commercial Handline fleet to model selectivity.

### 2.3.10. Recreational Catch Per Unit of Effort Indices of Abundance

Recreational indices were constructed using the Southeast Regional Headboat Survey and MRIP data and presented in SEDAR 74-DW-21 and SEDAR 74-DW-13. During the Data Workshop the indices were reviewed and the MRIP Private/Charter Boat derived indices (SEDAR 74-DW-13) were not recommended for inclusion in the assessment model due to the complexity of the management history for these fleets and sample size limitations, particularly in the east area. The indices constructed using the Headboat data (SEDAR 74-DW-21) for the east and central assessment areas were recommended for inclusion in the model. Initial model configurations attempted to include these indices; however, they were later removed due to concerns around the index standardization properly accounting for the complex Headboat management history and poor overall model fit for the index data. Therefore, no standardized CPUE indices based on the recreational fleet data were used in the assessment.



### 2.3.11 Shrimp Trawl Bycatch

Gulf of Mexico Shrimp Trawl bycatch data processing and analysis procedures are currently being re-evaluated to improve accuracy of Red Snapper bycatch estimates from the Shrimp Trawl fishery. This research is anticipated to be completed and reviewed for producing revised Shrimp Trawl bycatch estimates for the upcoming Red Snapper Operational Track Assessment. In the meantime, bycatch estimates from SEDAR 52 (SEDAR 2018) for statistical zones 1-12 (previous East subarea) were apportioned into the new Central (statistical zones 7-12) and East (statistical zones 1-6) areas (**Table 5**). Apportionment of the SEDAR 52 bycatch estimates into the SEDAR 74 three-area stock ID was done using refined estimates of 1985-2016 Shrimp Trawl effort for the new central and east areas (see section 3.5.1 in SEDAR (2022) for more details). For 1973-1984, the average proportion effort by area was computed for years 1985-1989 and then applied to the historical time series of Red Snapper bycatch estimates (**Figure 10**).

Because of the large uncertainty in the annual estimates of Shrimp Trawl bycatch, the bycatch discards were input as area-specific super period (i.e. median value from 1972-2017 of 264,000 east area fish, 727,000 central area fish and 13.9 million west area fish) which was then scaled annually by area-specific time series of Shrimp Trawl effort (available for 1950-2019; (**Figure 11**). Shrimp effort data were generated by the NMFS Galveston Lab using their SNpooled model (Linton, 2012; Nance 2004). The log SE for the mean discard numbers was set to 0.1. The Shrimp Trawl effort time series was scaled to a mean of 1 for input in the assessment model with an assumed constant CV of 0.2 (**Table 6**).

## 2.4. Fishery-Independent Surveys

### 2.4.1 SEAMAP Fall Plankton Survey

The primary objective of the SEAMAP Fall Plankton Survey (Larval Survey) is to collect and analyze ichthyoplankton samples in the Gulf of Mexico to produce a long-term database on the early life stages of fish in the region. These data were used to produce area-specific indices of abundance that were incorporated into the assessment model as indices of spawning stock biomass (SEDAR 74-DW-31). Central and west area indices were recommended for inclusion in the model with the east index being excluded due to low sample sizes. Indices were updated through 2019 and began in 1991 for the central area and 1986 for the west (**Tables 7-8 & Figures 12-13**). Annual CVs were scaled to a common mean of 0.2 and converted to log-scale SEs for input into the assessment model (**Tables 9-10**).

### 2.4.2. SEAMAP Trawl Survey

The primary objective of the SEAMAP Trawl Survey is to collect data on the abundance and distribution of demersal organisms in the northern GOM. Two indices of abundance were produced for each assessment area utilizing data from the summer (2009-2019) and fall portions of the survey (2008-2019). Furthermore, in the west assessment area, where longer term sampling has occurred, additional indices were produced using Summer Trawl Survey data from 1984-2008 and Fall Trawl Survey data from 1988-2007. West indices of abundance were input into the model as a separate “Early” and “Late” indices due to a substantial survey design change that took place during 2008. See SEDAR74-DW-30 for a full description of the methods used to develop this index.

This index was updated through 2019 (**Tables 3, 7, and 8 & Figures 12-14**). Annual CVs were standardized to a common mean of 0.2 and converted to log-scale SEs for input into the assessment model (**Tables 4, 9, and 10**).

Length composition for the SEAMAP Summer Trawl Surveys (See Figures 5 and 6 in SEDAR74-DW-30) were input as 5 cm binned nominal lengths with sample sizes specified as the number of stations sampled in a given year. Length converted age composition was used for the 2008-2019 SEAMAP Fall Trawl Surveys with sample size specified as number of fish. Development of the age-length keys is discussed in the working paper SEDAR74-DW-18. Age-length keys were not available far enough back in time to convert the west area 1988-2007 Fall Trawl Survey composition into age, so 5 cm binned length composition data were used with sample sizes input as the number of stations. Differences in composition approaches between the SEAMAP Summer and Fall Trawl Surveys stemmed from a need to limit requests on data providers during model development. Operational Track Red Snapper assessments following this Research Track Assessment will aim to utilize real age data for all fishery-independent indices and length-converted age if real age data are unavailable.

### 2.4.3. Video Surveys

An index of relative abundance was produced for the west assessment area using data collected by the NMFS SEAMAP Reef Fish Video Survey (SFRV). The combined video approach, briefly summarized below and described in SEDAR74-DW-23, was not used for the west area as the additional video surveys did not operate in the western assessment area. The SFRV west spans 1993-2019 with data gaps occurring in 1998-2001 and 2003 (**Table 8 & Figure 12**). Annual CVs were standardized to a common mean of 0.2 and converted to log-scale SEs for input into the assessment model (**Table 10**).

For the central and east assessment areas, combined video indices were produced using three different stationary video surveys for reef fish in the northern Gulf of Mexico (GOM). The NMFS SEAMAP Reef Fish Video Survey (SFRV), carried out by the NMFS Mississippi Laboratory, has the longest running time series (1993-1997, 2002, and 2004-2019), followed by the NMFS Panama City lab survey (PC; 2005-2019), with the most recent survey being the Florida Fish and Wildlife Research Institute video survey (FWRI, starting in year 2010). For more information on the survey methodology, see SEDAR74-DW-23. The East Combined Video Survey spans 2010-2019 and the Central Combined Video Survey covers 1993-2019 with data gaps in 1998-2001 and 2003 (**Tables 3, and 7 & Figures 13-14**). Annual CVs were standardized to a common mean of 0.2 and converted to log-scale SEs for input into the assessment model (**Tables 4, 9, and 10**).

Length compositions were input as nominal lengths with sample sizes specified as the number of survey stations from which successful measurements were obtained. Sample sizes below 10 trips annually were omitted.

### 2.4.4. NOAA NMFS Southeast Fisheries Science Center Bottom Longline Survey

The primary objective of NOAA NMFS Southeast Fisheries Science Center Bottom Longline Survey is to collect data on the abundance and distribution of fishes in the northern GOM. The

survey has been conducted annually since 1995 and was used to provide area-specific indices of abundance for SEDAR 74 (SEDAR 74-DW-26). For index construction, data was limited to 2001-2019 due to gear and survey design changes that occurred prior to 2001. Sample size limitations also resulted in the elimination of 2005 and 2008 for the west area, 2007 and 2008 for the central area, and 2002, 2008 and 2015 for the east (**Tables 3, 7, and 8 & Figures 12-14**). Annual CVs were standardized to a common mean of 0.2 and converted to log-scale SEs for input into the assessment model (**Tables 4, 9, and 10**).

Length-converted age composition was used for all areas and for all years for which samples were collected. Age compositions were input as nominal ages with sample sizes specified as the number of individuals measured.

#### 2.4.5 Great Red Snapper Count (GRSC)

A comprehensive GOM wide study aimed at estimating the absolute abundance of Red Snapper in the GOM was conducted between 2017 and 2019 (GRSC, Stunz et al. 2021). This study produced state-specific estimates of absolute abundance with associated measures of uncertainty. The estimates provided in Stunz et al. 2021 differ from those used in the assessment due to a NMFS requested reanalysis of the GRSC Florida estimate, the adoption of Louisiana estimates from an accompanying study (LGL 2022), and the need to group the state-based GRSC estimates into the three stock assessment areas. To accommodate the stock assessment areas, the absolute abundance estimate for the state of Florida was split into the east and central assessment areas based on an unpublished analysis of the Florida data (Robert Ahrens, personal communication) which indicated a 47.4% and 52.6% split for the central and east areas, respectively. For the central assessment area, the GRSC Mississippi-Alabama estimate (8,461,085) was added to 47.4% of the post-stratified Florida estimate (22,261,780), which was then added to 16.47% of the pipeline estimate (83,632), resulting in a total absolute abundance of 30,806,497 fish in the central area. In the eastern area 52.6% of the post-stratified Florida estimate (24,704,000) was added to 0.53% of the pipeline estimate (2,670), resulting in a total of 24,706,670 fish in the eastern area. The west area was composed of the GRSC estimate from Texas (22,025,035), the LGL estimate of abundance from Louisiana (8,377,591) as well as the remaining 83% of the fish associated with pipelines (421,359) for a total of 30,823,985. The CVs for each assessment area were calculated as the numbers weighted average of the state/regional/pipeline estimated CVs for each area (**Table 11**). Estimates were input into the assessment model as a single 2018 data point and modeled with catchability coefficients fixed at 1 (**Figure 15**). Length composition data provided from the study were not spatially robust nor likely representative of the population structure over the whole study area and were consequently not included in the model. Regional differences in study design resulted in an assumed survey selectivity of 100%, fixed for fish age-2+ in the eastern area and assumed dome-shaped selectivities freely estimated in the central and western areas (See sections 3.1.7.2, 4.8.6, and 5 in this report for additional details on how GRSC selectivity decisions were reached).



## 2.5. Environmental Considerations & Contributions from Stakeholders

### 2.5.1 Connectivity Modeling System (CMS) Index

The Connectivity Modeling System (CMS) is a biophysical modeling system based on a Lagrangian framework, and was developed to study complex larval migrations. The CMS uses outputs from hydrodynamic models and tracks the three-dimensional movements of advected particles through time, given a specified set of release points and particle behaviors, while simulating realistic larval behaviors such as ontogenetic vertical migration. Specifics on the hydrodynamic model forcing the simulation, and other details on how the simulation was parameterized specific to Red Snapper biology, are described in SEDAR 74-DW-24.

The recruitment index is a measure of the proportion of larvae that are expected to successfully settle to suitable recruitment habitat within the given biological constraints, due to the effects of oceanographic currents. The index thus represents a scalar on the total larval supply expected each year, prior to any density-dependent processes that act on the larvae upon settlement. Variance estimates for the index are obtained by running a range of sensitivities to the assumed larval depth distribution, providing a mean and annual standard deviation for the index.

The CMS index would potentially be incorporated into the model as an index of recruitment; however, it was not considered during SEDAR 74. The primary value of the index is believed to lie in its ability to provide recruitment strength and potentially apportionment information in the most recent years of the assessment for which little other informative data (e.g., length/age composition) exist. The recent year class strength is influential in determining quantities like stock status and forecasting yields which were not undertaken during the Research Track process. Consequently, the index was not incorporated; however, its utility will be explored during the upcoming Operational Track Assessment of GOM Red Snapper.

### 2.5.2 Other Environmental Considerations Reviewed But Not Incorporated

A number of other environmental factors were identified during the Data Workshop which could potentially be considered for incorporation into the stock assessment as drivers of various population dynamic processes. Notable examples include the effects of seasonal and episodic hypoxia events in the northern GOM which are commonly observed with severe events found to be correlated with poor juvenile survival in the hypoxic zones; changes in diet and trophic ecology of Red Snapper associated with degraded habitat, particularly following the Deepwater Horizon oil spill, and increased competition from invasive Lionfish; and increased depredation following release due to the recovery of GOM shark and marine mammal populations. These and others detailed in SEDAR (2022) warrant further investigation; however, the lack of actionable timeseries of environmental covariates and testable hypotheses prevented the inclusion of these environmental factors in SEDAR 74.

### 3. Stock Assessment Model Configuration and Methods

#### 3.1. Stock Synthesis Model Configuration

The assessment model used was Stock Synthesis (SS), version 3.30.20. Descriptions of SS algorithms and options are available in the SS User's Manual (Methot et al. 2020), the NOAA Fisheries Toolbox website (<http://nft.nefsc.noaa.gov/>), and Methot and Wetzel (2013). Stock Synthesis (SS) is a widely used integrated statistical catch-at-age model (SCAA) that has been tested for stock assessments in the United States (US), particularly on the West Coast and Southeast, and also throughout the world (see Dichmont et al. 2016 for review). SCAA models consist of three closely linked modules: the population dynamics module, an observation module, and a likelihood function. Input biological parameters (e.g., **Section 2.2**) are used to propagate abundance and biomass forward from initial conditions (population dynamics model) and SS develops predicted data sets based on estimates of fishing mortality, selectivity, and catchability (the observation model). The observed and predicted data are compared (the likelihood module) to determine best-fit parameter estimates using a statistical maximum likelihood framework (detailed in Methot and Wetzel (2013)). Because many inputs are correlated, the concept behind SS is that processes should be modeled together, which helps to ensure that uncertainties in the input data are properly accounted for in the assessment.

The GOM Red Snapper SS model assumed for SEDAR 74 differed greatly from any previous model configuration for GOM Red Snapper. The fully configured SS model included three distinct spatial areas (West, Central, and East) each with observations of catch and discards for five directed fishery fleets (Commercial Handline, Commercial Longline, Recreational Private, Charter Boat, and Headboat) and one bycatch fleet (Shrimp Trawl). For the commercial fleets and the Recreational Private and Charter Boat fleets, discards were separated into open and closed season components to enable the closed season discards to be modeled independently of the open season fishing dynamics. The model included 21 total indices of abundance spread among the three areas. The west spatial area incorporated the fishery-independent SEAMAP Video Survey, Bottom Longline Survey, SEAMAP Fall Plankton Survey (Larval Survey), a Great Red Snapper Count (GRSC) derived index of absolute abundance, and the Summer and Fall SEAMAP Trawl Surveys each split into two indices (Early and Late). The central spatial area utilized the fishery-independent Combined Video Survey, Bottom Longline Survey, Larval Survey, a GRSC derived index of absolute abundance, and the Late variant of the Summer and Fall SEAMAP Trawl Surveys. The east spatial area included two fishery-dependent indices of abundance (Commercial Handline and Commercial Reef Fish Observer), as well as the fishery-independent Combined Video Survey, Bottom Longline Survey, a GRSC derived index of absolute abundance, and the late variant of the Summer and Fall SEAMAP Trawl Surveys. Model estimated parameters include fishing mortality by fleet and spatial area for each year, selectivity and retention for each directed fleet, selectivity for the indices of abundance, excluding the east spatial area GRSC index (See **Section 3.1.7.2**), initial recruitment, stock-recruit deviations, recruitment base apportionment, recruitment apportionment deviations, index catchabilities, and Dirichlet-multinomial parameters.

The SS modeling framework provides estimates for key derived quantities including: time series of recruitment (units: 1,000s of age-0 recruits), abundance (units: 1,000s of fish), biomass (units: metric tons), SSB (units: metric tons), and harvest rate (units for Red Snapper: total biomass

killed age 2+ / total biomass age 2+). The r4ss software (Taylor et al. 2021) was utilized extensively to develop various graphics for model outputs and was also used to summarize various output files.

Projections and the standard diagnostic runs were not completed as part of the Research Track Assessment as the data are not yet final. The assessment developed here is meant to serve as the structure with which final data will be fit during the Operational Track Assessment.

### 3.1.1. Initial Conditions

The Gulf of Mexico (GOM) Red Snapper assessment has a start year of 1950 and a terminal year of 2019. Removals of Red Snapper were known to occur in the GOM prior to 1950, primarily by the Commercial Handline fleets and to a lesser extent the recreational fisheries. Therefore, initial depletion was estimated using estimates of initial catch for fleets with significant landings at the beginning of the time series (i.e., Commercial Handline for all areas and all recreational fleets except Headboat in the east area). Initial catch values for the recreational fleets were set equal to each fleet's catch (in numbers of fish) in 1955, which was the first available data year. This resulted in initial fishing mortality rates of the recreational fleets being based on landings of 386,180 for West Charter Boat; 220,670 for Central Charter Boat; 62,070 for East Charter Boat; 317,220 for West Headboat; 124,130 for Central Headboat; 0 for East Headboat; 137,920 for West Recreational Private; 110,340 for Central Recreational Private; and, 24,830 for East Recreational Private. Commercial initial catch values were set equal to the average catch from 1930 to 1949. This resulted in initial fishing mortality rates for the commercial fleets being based on landings of 265 metric tons for the West Commercial Handline, 614 metric tons for the Central Commercial Handline, and 457 metric tons for the East Commercial Handline. For all fleets with initial catch, CVs of 0.01 were used to force the model to fit the initial catch values and the resulting estimates of  $F$  were applied by SS to achieve a plausible non-virgin initial population structure.

### 3.1.2. Temporal Structure

The Red Snapper population was modeled from age-0 through age-20+ fish, with the last age representing an accumulating plus group. The inclusion of a seasonal component to the removals was not considered for the Research Track Assessment thus the model time step was set equal to one year with fishery activity assumed to be continuous and homogeneously distributed throughout the year. Temporal structure in fleet behavior (i.e., selection and retention) were created using time blocking of parameter estimates (i.e., different values for retention parameters for one time period versus another). Larval settlement was specified to occur on July 1st corresponding with a period of elevated spawning during the protracted Red Snapper spawning season. Indices of abundance, length and age composition were assumed to be collected on July 1st for all fleets and surveys with the exception of the SEAMAP Fall Trawl Survey which was assumed to have occurred September 1st.

### 3.1.3. Spatial Structure

A three area model was implemented where recruits were assumed to be generated from a single stock recruitment relationship and then divided among the three assessment areas. Recruits were split into the three areas using the base recruitment apportionment parameters for all years until

1975 after which annual apportionment deviations were estimated and used to modify the base apportionment parameters. To improve model stability, priors were used to inform the estimation of the base apportionment parameters. The priors were calculated using the nominal catch per unit effort (CPUE) data from the SEAMAP Fall Plankton Survey (see Table 3 In SEDAR74-DW-31). Area-specific priors were calculated as the log of the average 2009-2019 CPUE divided by the average CPUE for the same time period from the reference area. Using the west area as the reference area, this resulted in priors of 0, -0.620 and -2.085 for the west, central and east areas, respectively. Priors were input as normal with a standard deviation (SD) of 0.5. The standard error of the apportionment deviations was fixed at 0.5 to moderate the model estimated variability in interannual recruitment deviations. Once settled, recruits followed area-specific life history and mortality parameters with no adult movement among areas assumed.

### 3.1.4. Life History

A fixed length-weight relationship was used to convert body length (cm Fork Length, FL) to body weight (kg whole weight; See Table 9 in SEDAR (2022), Figure 3). Length-weight relationships were not estimated by spatial area so common parameters were applied to all three areas. Stock Synthesis (SS) moves fish among age classes and length bins on January 1<sup>st</sup> of each modeled year starting from birth at age-0. The true birth data for Red Snapper in the GOM does not occur on January 1<sup>st</sup>, with peak spawning occurring around July 1<sup>st</sup>. Unlike previous SS versions, SS version 3.30.20 allows settlement timing to be specified in the model allowing for growth and natural mortality parameters to act for the appropriate amount of time on the age-0 cohort. Slight alterations in growth ( $t_0$ , or the age at length 0) and natural mortality parameters previously required to account for the difference between true age and modeled age were no longer needed.

Growth was modeled with a three parameter von Bertalanffy equation: (1)  $L_{Amin}$  (cm FL), the mean size at age-0.25 for Red Snapper; (2)  $L_{Amax}$  (cm FL), the mean size at maximum age for Red Snapper; and (3)  $K$  ( $\text{year}^{-1}$ ), the growth coefficient. In SS, when fish recruit at the real age of 0.0 they have a body size equal to the lower limit of the first population bin (fixed at 10 cm FL). Fish then grow linearly until they reach a real age equal to the input value of  $A_{min}$  (growth age for  $L_{Amin}$ ) and have a size equal to  $L_{Amin}$ . As they age further, they grow according to the von Bertalanffy growth equation (Figure 3).  $L_{Amax}$  was specified as equivalent to  $L_{inf}$ . Two additional parameters are used to describe the variability in size-at-age and represent the CV in length-at-age at  $A_{min}$  (age-0.25) and  $A_{max}$  (age-20). For intermediate ages, a linear interpolation of the CV on mean size-at-age is used.

Spatial area-specific von Bertalanffy growth model parameters  $L_{Amin}$ ,  $L_{Amax}$  and  $K$  were estimated externally to SS using updated length and age compositions Table 12. Variance parameters for the west area  $CV_{Amin}$  (0.252) and  $CV_{Amax}$  (0.063), central area  $CV_{Amin}$  (0.318) and  $CV_{Amax}$  (0.057), and east area  $CV_{Amin}$  (0.394) and  $CV_{Amax}$  (0.041), were fixed at the values recommended at the SEDAR 74 (see Table 4 in SEDAR 2022) Data Workshop.

The age-specific vector of  $M$  (Section 2.2.3) was assumed to be constant across the three spatial areas and was fixed within the SS model (Table 1).

Maturity was modeled as an age-logistic relationship with no truncation on first mature age (i.e. fish could theoretically mature at age 0). Several time-varying approaches to modeling

maturity were considered (**Section 3.4.7**); however, for the base model configuration, maturity was assumed to be area-specific and constant across time (**Table 2**). Fecundity was configured using a weight based relationship ( $eggs = aWt^b$ ) that was parameterized with both the alpha and beta parameters fixed to 1 to ensure that derived population biomass metrics were in units of spawning stock biomass.

### 3.1.5. Recruitment Dynamics

A Beverton-Holt stock-recruit function was used to parameterize the relationship between spawning output and resulting recruitment of age-0 fish. The stock-recruit function (representing the arithmetic mean spawner-recruit levels) requires three parameters: (1) steepness ( $h$ ) characterizes the initial slope of the ascending limb (i.e., the fraction of virgin recruits produced at 20% of the equilibrium spawning biomass); (2) the virgin recruitment ( $R_0$ , estimated in log space) represents the asymptote or virgin recruitment levels; and (3) the variance or recruitment variability term ( $\sigma_R$ ) which is the SD of the log of recruitment (it both penalizes deviations from the spawner-recruit curve and defines the offset between the arithmetic mean spawner-recruit curve and the expected geometric mean from which the deviations are calculated). The steepness parameter,  $h$  and  $\sigma_R$  were fixed at 0.99, and 0.6, respectively, in the SEDAR 74 base model. Virgin recruitment ( $\ln R_0$ ) was freely estimated. Steepness was fixed as a computational convenience assuming no stock-recruitment relationship, but rather average recruitment from a mean.  $\sigma_R$  was fixed at a recommended value for model stability.

Annual deviations from the stock-recruit function were estimated in SS as a vector of unconstrained deviations (i.e., deviations do not sum to zero) assuming a lognormal error structure, with the level of variability set by  $\sigma_R$ . A lognormal bias adjustment factor was applied to recruitment estimates as recommended by Methot et al. (2020), but only to the data-rich years in the assessment. This was done so that SS will apply the full bias-correction only to those recruitment deviations that have enough data to inform the model about the full range of recruitment variability (Methot et al. 2020). For the SEDAR 74 base model, main period (i.e. data rich) recruitment deviations spanned 1990-2016. Full bias adjustment was used from 1984 to 2019 when length or age composition data were available. Bias adjustment was phased in linearly, from no bias adjustment prior to 1980 to full bias adjustment in 1984. Bias adjustment was phased out in 2019, decreasing from full bias adjustment to no bias adjustment in that year, because the age composition data contains less information on recruitment in more recent years. The years selected for full bias adjustment were estimated following the methods of Methot and Taylor (2011).

### 3.1.6. Fleet Structure and Surveys

For each of the three spatial areas (W, C, and E), five fishing fleets were modeled and had associated length compositions. No age composition was incorporated into the model for the fishing fleets. The SS fleet codes for these were: Commercial Handline (HL\_W, HL\_C, HL\_E), Commercial Longline (LL\_W, etc.), Recreational Charter Boat (CBT\_W, etc.), Recreational Headboat (HBT\_W, etc.), Recreational Private (PRIV\_W, etc.). Discards were incorporated as total discards in 1000s of fish for all fleets in all areas. Prior to the onset of the commercial Individual Fishing Quota (IFQ) Program in 2007, discards in the commercial fleets were separated into those occurring in open and closed fishing seasons. With the IFQ program in place, commercial discards were assumed to occur continuously throughout the year in

conjunction with an assumed year long fishing season. Recreational Private and Charter Boat discards were separated into open and closed season discards to account for the differing discard practices of anglers when harvest was or was not an option. Recreational Headboat discards could not be separated into their open and closed components due to the lack of a subannual breakdown of discards provided for the Research Track Assessment. Therefore the discards were modeled together and assumed to have consistent practices throughout the year. Separation of Headboat discards into open and closed season subsets can be attempted as part of the Operational Track Assessment if monthly or bimonthly estimates of Recreational Headboat discards are available.

Discards from the Shrimp Trawl fishery in the GOM were included by fitting median Shrimp Trawl bycatch levels and indices of Shrimp Trawl fishing effort. Shrimp Trawl bycatch was assumed to be 100% dead discards with no landings. For Shrimp discards the ‘super-year’ approach was utilized to avoid fitting to the extremely noisy and uncertain yearly estimates of Shrimp bycatch. The premise of a super-year is that, instead of fitting each observation directly, a measure of central tendency for the entire time series is fit. In the case of Shrimp bycatch, the median has typically been utilized (i.e., the observed median is fit to the predicted median). The model still predicts annual bycatch values using annual  $F$ s estimated from area-specific time series of Shrimp Trawl effort, but does not directly fit the annual Shrimp Trawl bycatch observations owing to the high uncertainty associated with them. The super-year covers years 1973-2019 (i.e., the median values correspond to observed and predicted bycatch values for these years).

Two fishery-dependent CPUE indices, both occurring in the east area, were included in the SEDAR 74 base model: Commercial Reef Fish Observer Program index (COMMOBS\_E) and Commercial Handline index (HL\_E). The fishery-dependent CPUE series were treated as indices of biomass where the observed standardized CPUE time series was assumed to reflect annual variation in population trajectories. Both fishery-dependent indices were input as surveys into SS (see **Section 2.3.9**) and the selectivity for the Commercial Reef Fish Observer Program was mirrored to length selectivity of the Commercial Handline East fleet.

The inclusion of fishery-independent surveys differed among the assessment areas with spatial, temporal and sample size limitations dictating availability. In the west assessment area, seven fishery-independent surveys, one absolute index of abundance (GRSC) and one time series of Shrimp Trawl effort were included in the SEDAR 74 base model. The fishery-independent surveys included: the SEAMAP Fall Plankton Survey, temporally split Early and Late Summer SEAMAP Trawl Surveys, temporally split Early and Late Fall SEAMAP Trawl Surveys, the Bottom Longline Survey and the SEAMAP Video Survey. The central assessment area had five fishery-independent surveys, one absolute index of abundance (GRSC) and one time series of Shrimp Trawl effort included in the SEDAR 74 base model. The fishery-independent surveys included: the SEAMAP Fall Plankton Survey, Late Summer and Late Fall SEAMAP Trawl Surveys, the Combined Video Survey, and the Bottom Longline Survey. The east assessment area had four fishery-independent surveys, one absolute index of abundance (GRSC), and one time series of Shrimp Trawl effort included in the SEDAR 74 base model. The fishery-independent surveys included: the Late Summer and Late Fall SEAMAP Trawl Surveys, the Combined Video Survey, and the Bottom Longline Survey.



The fishery-independent surveys, GRSC absolute abundance index, and Shrimp Trawl effort time series were incorporated consistently among areas when available. For the central and west areas, the Larval Survey was set up as a special survey of spawning stock biomass. The SEAMAP Trawl Surveys (early and late), Bottom Longline Surveys and the Video Surveys (SEAMAP in the west and Combined Video in the east and central) were incorporated as indices of relative abundance and had composition data (either age or length) available which was fit directly based on estimated area-specific selectivity functions. For all areas, the Shrimp Trawl effort time series was input as effort and used to scale the annual fishing mortality estimates associated with the bycatch fishery. In all areas, the GRSC index was input in 1000s of fish and incorporated as an index of absolute abundance (i.e., catchability coefficient fixed at 1). The lack of robust, GRSC survey-specific composition data precluded the direct fitting of selectivity curves for the survey in all areas. In the absence of data, regional differences in GRSC study design were used to inform the selectivity assumptions of the survey outlined in **Section 3.1.7.2**.

### 3.1.7. Selectivity

Selectivity represents the probability of capture by age or length for a given fleet and represents the net result of multiple interrelated factors (e.g., gear type, targeting, and availability of fish due to spatial and temporal constraints). Stock Synthesis (SS) allows users to specify length-based selectivity, age-based selectivity, or both. The final selectivity curve governing each fleet/survey reflects the additive effect of both age- and length- based processes when both data types are present.

Selectivity patterns were not assumed to be constant over time for each fleet and survey. The commercial and recreational fisheries have experienced numerous management changes to both minimum size and bag/trip limits since the mid-1980's. For the commercial fleets, the onset of restrictive trip limits in 1993 and the switch to an individual fishing quota system in 2007 were hypothesized to be events likely to result in angler selectivity changes. To accommodate this in the model, time blocks on commercial selectivity were implemented for 1950-1992, 1993-2006 and 2007-2019. Similarly, changes to recreational selectivity were thought to coincide with enforcement of a five fish bag limit in 1995 and the further reduction to a two fish bag limit in 2007. Assuming that fishers were shifting fishing locations and changing gear (i.e., hook size) to optimize their bag limit as it was reduced, thus impacting selectivity. In addition all fleets were required to switch from J hooks to circle hooks in 2007 which likely resulted in additional selectivity change across all angling sectors. Thus, three selectivity time blocks were used to model all recreational fleets and were 1950-1994, 1995-2006 and 2007-2019. Selectivity time blocks for a given sector were applied consistently across all assessment areas because relevant management events were enacted GOM wide for all components of a given sector at the same time (e.g., commercial changes affected both the Handline and Longline fleets simultaneously in all areas). There have been many changes to recreational and commercial minimum size limits throughout the GOM Red Snapper management history. These changes were assumed to influence the discard patterns more so than selectivity. As such, these changes were accounted for in the assessment model using time-varying retention patterns (see **Section 3.1.8.**) and modeling discards explicitly (see **Section 3.1.10.**).

In general, surveys were assumed to have constant selectivity; however, some exceptions did exist. In all but one case, surveys which likely experienced time-varying selectivity due to significant design or gear changes were handled by either truncating the index time series at the

year of the change or by splitting the index into two parts (e.g., “early” and “late” SEAMAP Trawl Surveys in the west area). The one exception was the central Combined Video Survey which was modeled using time-varying selectivity. The central Combined Video Survey was composed of three separate video surveys which operated for different lengths of time in spatially restricted and disparate parts of the GOM. The longest running survey was restricted to deeper waters near the shelf break where older and larger Red Snapper are known to occur at higher relative abundance. The other two surveys operated in shallower water in the northern GOM and west Florida shelf and consequently were primarily observing a younger and smaller subset of the overall Red Snapper population. Selectivity blocks were introduced to account for the changing availability of various subsets of the Red Snapper populations as the three video surveys were introduced in the central assessment area (1993-2005, 2006-2015, and 2016-2019). Similar approaches were not needed for the west video survey because it only made use of one (SEAMAP Video Survey) survey or for the east because the time series was truncated to begin in 2010 when all three surveys were in operation in the east assessment area (see Table 1 SEDAR74-DW-23).

### 3.1.7.1. Length-based Selectivity

Length-based selectivity patterns were specified for each fleet and survey with included length composition data. Length-based selectivities were characterized as one of two functional forms: (1) a two-parameter logistic function (SS pattern 1) and (2) a six-parameter double normal function (SS pattern 24). A logistic curve typically implies that fish below a certain size range are not vulnerable, but gradually increase in vulnerability with increasing size until all fish are fully vulnerable (asymptotic selectivity curve). Two parameters describe logistic selectivity: (1) the length at 50% selectivity, and (2) the difference between the length at 95% selectivity and the length at 50% selectivity, which were both estimated in this assessment. The double normal has the feature that it allows for domed or logistic selectivity and is a combination of two normal distributions; the first describes the ascending limb, while the second describes the descending limb. A line segment joins the maximum selectivity of the two functions. However, the double normal functional form can be more unstable than other selectivity functions due to the increased number of parameters. When robust length or age compositions are available with sufficient numbers of larger or older fish, it may be appropriate to freely estimate all parameters (especially the descending limb). If that is not the case, certain parameters can be fixed to improve model stability as long as fixing the parameter does not largely influence the point estimates of the remaining selectivity parameters.

In the SEDAR 74 base model, selectivity patterns were defined for each fleet/survey/spatial area combination and forms were consistent across the spatial areas for any given fleet or survey. The selectivities of the Commercial Handline fleets, the east area Commercial Reef Fish Observer index of abundance, the Recreational Charter Boat fleets, Private fleets and the Headboat fleets were all modeled using double normal functional forms. Logistic selectivity was applied to the longline fleets and the video surveys since there was no evidence in their respective length composition data to suggest a lack of availability of larger size classes. Logistic selectivity was also used to model selectivity for the Early SEAMAP Fall Trawl Survey in the west area and for the Shrimp bycatch in all areas; however, in these cases the slope of the logistic function was constrained to be less than 0 forcing selectivity to decline toward 0 with increasing size. The SEAMAP Summer Trawl Surveys (Early and Late) were modeled using a 3-node cubic spline. The cubic spline form was adopted due to fit and stability issues that arose during earlier



attempts to apply a negative slope logistic curve as was done for the Fall Trawl Surveys. Fit issues with the negative slope logistic curve were thought to be due to the timing of the Summer Trawl Surveys resulting in low catches of age-0 Red Snapper (i.e. the surveys occurred during or just prior to spawning) and high catches of age-1 Red Snapper in most years. Lastly, selectivity forms for all closed season discards followed the form of their open season counterpart (e.g. Longline closed season discards were modeled using logistic selectivity and Charter Boat closed season discards followed a double normal form, etc.).

Double normal selectivity was implemented for all recreational fleets and for the Commercial Handline fleets because dome-shaped selectivity was considered highly likely due to areas fished (e.g., closer to shore, shallower) and targeting behavior. For the Commercial Handline fleets, in the base selectivity time block (1950-1992), the estimation ignored the first and last size bins and allowed SS to decay the small and large fish selectivity according to parameters of ascending width and descending width, respectively, to reduce the number of parameters being estimated and improve model stability. All subsequent time blocks for the Commercial Handline fleet had sufficiently robust enough composition data to allow estimation of all six double normal parameters. For the non-mirrored (See **Section 3.1.7.3**) recreational fleet selectivities and the Commercial Reef Fish Observer Program, all six double normal parameters were estimated for all time blocks

All non-mirrored (See **Section 3.1.7.3**) fleets using logistic selectivity (longline fleets, video surveys, the Shrimp Trawl bycatch and the west area Fall Early SEAMAP Trawl Survey) had both parameters estimated for all time blocks. The Shrimp Trawl bycatch and Fall Early SEAMAP Trawl Survey had bounds set on the slope parameter to force it to be below 0. All other logistic forms had slopes greater than 0 ensuring that selectivity would approach 1 with increasing size.

The 3-node splines used to model the Summer SEAMAP Trawl Survey were set up following the guidance in Methot et al. (2020). Node locations were auto generated using the SS software and placed based on percentiles of the cumulative size distribution for each survey. Node locations were subsequently fixed and the slope of the curve at nodes 1 and 3 were freely estimated relative to node 2 which was fixed in all cases.

The selectivity of the Larval Surveys did not need to be specified as the surveys were set up as relative indices of spawning stock biomass.

### **3.1.7.2. Age-based Selectivity**

Age-based selectivity was specified for the Bottom Longline Surveys, the Late Fall SEAMAP Trawl Surveys and the indices of absolute abundance derived from the Great Red Snapper Count (GRSC). The Bottom Longline Surveys were fit assuming age-logistic selectivity parameterizations with no time blocks and all parameters freely estimated. The Late Fall SEAMAP Trawl Survey composition was fit using an empirical random walk for age-0 to age-4 with no time-varying component. The Late Fall SEAMAP Trawl Survey was range restricted to force selectivity to be declining as age increases with age-4 having a final selectivity of 0. Restrictions were put in place based on the design of the survey (targeting age-0), previous assessment fits to the survey, and visual inspection of the composition. Initial attempts to freely estimate the random walk resulted in an unstable model that would occasionally produce

implausible selectivity forms (e.g. the model estimated a logistic form selectivity curve despite no old fish in the observed composition).

The GRSC survey was modeled assuming 100% selectivity for all ages-2+ in the east area, while the west and central areas assumed double normal estimated selectivity with age-0 and age-1 forced to have 0% selectivity. Differences in selectivity form were due to regional differences in sampling design from the original study that were thought to lead to gear availability limitations for the oldest age groups in the central and west areas. The assumption of 0% selectivity for age-0 and age-1 was based on the original GRSC study design's explicitly stated goal of counting only age-2+ Red Snapper. The GRSC index was fit for 2018 only, so no time-varying component was necessary.

### 3.1.7.3. Mirroring

Compositional sample size limitations necessitated several fleets mirroring the selectivity of the same fleet in a neighboring spatial area. This need arose most commonly in the east area where all recreational fleets (Charter Boat, Private, and Headboat) were mirrored to their central area counterparts' length-based selectivity. Likewise, the central area Commercial Longline fleet lacked sufficient compositional data and had its length-based selectivity mirrored to the Commercial Longline fleet in the west area. In all cases, the area mirrored to was chosen because it had the most similar fleet dynamics to the area lacking compositional data. All closed season discard fleets had their length-based selectivities mirrored to their corresponding open season fleet. This assumed that angler behavior, as it relates to selectivity, was constant regardless of an angler's ability to land a Red Snapper.

### 3.1.7.4 Selectivity Priors

All estimated selectivity parameters for age and length selectivity used symmetric Beta priors with  $SE = 0.5$ . These priors are diffuse and serve primarily to help move parameters out of the tails of their range in situations where the parameter gradient has approached 0 despite failing to find a global minimum.

### 3.1.8. Retention

Time-varying retention functions are commonly used in GOM stock assessments to allow for varying discards at size due to the impacts of management regulations. For Red Snapper, time blocks were based on changes in the federal and state waters minimum size limits. The time varying retention blocks were defined as:

1. For commercial fishing fleets:
  - a. 1950 - 1984: no minimum size limit regulation in place
  - b. 1985 - 1994: 13 inch minimum size limit
  - c. 1995 - 2006: 15 inch minimum size limit
  - d. 2007 - 2019: 13 inch minimum size limit
2. For recreational fishing fleets:
  - a. 1950 - 1989: no minimum size limit regulation in place
  - b. 1990 - 1994: 13 inch minimum size limit
  - c. 1995 - 1998: 15 inch minimum size limit

- d. 1999 - 1999: 18 inch minimum size limit
- e. 2000 - 2019: 16 inch minimum size limit

For each fleet, the retention function was specified as a logistic function consisting of four parameters: (1) the inflection point, (2) the slope, (3) the asymptote, and (4) the male offset inflection (not applicable to this model and assumed to be zero). The blocks listed above related to the minimum size limits were linked to the inflection point for all fleets and the slope parameters for all fleets except the east area recreational fleets which made use of one slope time block from 2007-2019. The east recreational fleet slope parameters were handled separately due to a lack of robust landed or discarded composition data in the area.

High grading, or the discard and release of legal-sized fish, was acknowledged as a possible concern for both the commercial and recreational fleets with the onset of IFQs and 2-fish bag limits, respectively. Consequently, all commercial and recreational fleets had a time-block implemented for asymptote parameters from 2007-2019. These blocked parameters were estimated to allow the model the flexibility to discard legal-sized fish which was supported by both the available discard composition and knowledge of recent angler behavior in response to regulation.

For the commercial fleets, prior to 1995 discards were not tabulated and before 2007 no commercial discard composition data were collected. Consequently, the first three commercial retention blocks had the inflection points fixed at 8 inches TL prior to regulation and at the minimum size limits of 13 and 15 inches total length for the 1985-1994 and 1995-2006 blocks, respectively. The inflection point for the 2007-2019 block was freely estimated to make use of the available discard compositional data from that time-period. In nearly all cases, slope parameters were freely estimated for all blocks except the first to allow the model flexibility to fit a small amount of sublegal fish that occurred in the landed composition data for the commercial fleets. The first time-block had the slope parameter fixed at 1 which imposes knife-edged retention, allowing for full selection at the minimum size limit. Additionally, the Commercial Longline East fleet had the slope parameter for the 1985 and 1995 time-block fixed at one due to the model initially trying to estimate these parameters near the lower bound of 0. Lastly, the asymptote parameter was fixed at 100% retention of legal sized fish for all periods prior to 2007 after which the parameter was freely estimated to allow for the possibility of high grading in the commercial fishing sector.

Recreational discards have been estimated since 1981; however, compositional data has only recently begun to be collected and only in Florida, limiting its utility for a GOM wide assessment. Given the lack of discard composition data, the decision was made to fix the inflection parameters at 8 inches total length for the pre-regulation period (prior to 1990) and at the minimum size limit for all subsequent recreational time blocks. For the central and west areas, retention was assumed to be knife-edged prior to 1990 with the slope parameter fixed at 1 for all recreational fleets. The remaining four slope parameter time blocks, for the central and west areas, had parameters freely estimated for all fleets to allow for the modeling of sublegal fish in the landed composition data. The east area had two time blocks for the slope parameters separated in 2007. Prior to 2007 the slope parameter was fixed at 1 and freely estimated after. Difference in approach among areas was due to the lack of both landed and discard composition data for the east area fleets prior to 2007. Lastly, the asymptote parameter was fixed at 100%

retention of legal sized fish for all areas, fleets, and time blocks prior to 2007. After 2007 the parameter was freely estimated for all areas and fleets to allow for the possibility of high grading in the recreational fishing sector.

### 3.1.9. Landings and Associated Length and Age Compositions

Landings by fleet and associated length and age compositions were estimated using fleet-specific continuous fishing mortality rates and length-specific selectivity curves following Baranov's catch equation.

The commercial landings were assumed to be the most representative and reliable data source in the model, especially over the most recent time period. Since 2007 this information was collected in the form of a census as opposed to being collected as part of a survey and a CV of 0.05 was assumed. Prior to 2007, commercial landings were estimated from self reported logbook data which led to fleet and area-specific estimates of annual CVs presented in the Data Workshop Report (SEDAR 2022). Attempts were made to utilize all recommended CVs but doing so resulted in unacceptable levels of model instability. Test runs indicated that sufficient model stability could be achieved if commercial landings CVs were fixed at 0.05 prior to 1995 and the data workshop recommended CVs were used for all other years. Stability was likely achieved here due to the onset of other sources of data, in particular robust compositional data. Similarly, the recreational landings were assumed to be less precise than the commercial landings and had a CV of 0.15 assumed for all recreational fleets prior to 1995 and the data workshop recommended CVs for all other years. All CVs were converted to a log-scale SE (see **Section 3.2.**).

The Dirichlet-multinomial (DM) which differs from the standard multinomial in that it includes an estimable parameter ( $\theta$ ) which scales the input sample size (Thorson et al. 2017; Methot et al. 2020) was used to weight the composition data for SEDAR 74. The DM is self-weighting, which avoids the potential for subjectivity as when the Francis re-weighting procedure is applied (Francis 2011). The DM likelihood also allows for observed zeros in the data, and the effective sample sizes calculated are directly interpretable. The DM uses the input sample sizes directly, adjusted by an estimated variance inflation factor. The more positive the inflation factor, the more weight the data carry in the likelihood. The DM is considered an improved practice and recommended for use by the SS model developers, and was first used in a GOM stock assessment during SEDAR70 in 2020 for GOM Greater Amberjack.

Because SS models individual fish growth internally and tracks fish from birth, it grows fish by length bins before eventually converting lengths to ages (based on the growth curve). As such, it is possible to fit both age and length composition simultaneously. For SEDAR 74, the age and length composition data for each fleet/survey were assumed to follow a Dirichlet-multinomial error structure where sample size represented either trips, survey stations, individual fish or number of sets, adjusted by an estimated variance inflation factor. Data sources varied in the units of sample sizes provided, leading to a mix of units used in the model. Future models aim to use a common unit of sample sizes. See **Sections 2.3.5-2.3.8** and **Sections 2.4.2-2.4.5** for more detail on input sample sizes for each fleet/survey. The final effective sample sizes for each year are provided on the figures illustrating the fits to the observed age and length composition data (given by  $N_{adj}$  in each panel; **Figures 16-48**).

### 3.1.10. Discards

Discard data for each fleet were directly fit in the SS model using size-based retention functions, and a log-normal error structure was assumed. Annual estimated CVs were provided in the data workshop report (SEDAR 2022) and converted to log-scale SE for input into SS. The model estimates total discards based on the selectivity and retention functions, then calculates dead discards based on the spatially-specific but time invariant discard mortality rates which ranged from 16.9% to 41.2% for the recreational fleets and 19.2% to 40.7% for the commercial fleets (Sections 2.3.3-2.3.4). A lambda weighting factor was imposed on the east-area Recreational Private Closed Season discards to force the model to more closely fit the observed data. This discard time series is unique among the closed season discard fleets in that it typically has low observed discards with a couple years of very high and highly uncertain discards reported (if there is a figure for this ref here). When freely estimated the model would generally fit the observed discards; however, for the high observed discard years (2011 and 2016) the model would estimate expected discards far in excess of the observed discards. This resulted in extreme  $F$  estimates that had substantial impacts on east area population abundance and compositional structure. Given the highly uncertain nature of the closed season recreational discard data, it was determined to be more appropriate to constrain these estimates rather than allow for the irregular freely estimated results to exert undue influence over the other modeled quantities.

### 3.1.11. Indices

The indices are assumed to have a lognormal error structure. The CVs provided by the index standardization were standardized to a common mean CV of 0.2 and converted to a log-scale SE required for input to SS for lognormal error structures (Section 3.2.). Scaling CVs to a common mean was used in the previous Red Snapper assessment because indices are standardized using different techniques and the output SEs are not directly comparable, nor do they adequately characterize the relative confidence in the various indices. Scaling each index to a common mean allows them to be equally weighted within the assessment, while maintaining relative annual variation (Francis et al. 2003). This was a much needed model simplification assumption as trying to determine the correct scaling of one index to another can be subjective, and determining the criteria for judgment was out of the scope of the Research Track Assessment.

## 3.2. Goodness of Fit and Assumed Error Structure

A maximum likelihood approach was used to assess goodness of model fit to each of the data sources (e.g., catch, indices, compositions, etc.). For each separate data set, an assumed error distribution and an associated likelihood component was specified, the value of which was determined by the difference in observed and predicted values along with the assumed variance of the error distribution. The total likelihood was the sum of each individual component. A nonlinear iterative search algorithm was used to minimize the total negative log-likelihood across the multidimensional parameter space to determine the parameter values that provide the best fit to the data. With this type of integrated modeling approach, data weights (i.e., the variance associated with each data set) can impact model results, particularly if the various data sets indicate differing population trends.

SS allows, through a lambda parameter, for additional weight to be assigned to components of the overall likelihood to either increase or decrease the likelihood penalty associated with

misfitting the specified data source. For SEDAR 74 lambdas were imposed for the east area Private landings, Closed Season Commercial Handline discards, Closed Season Private discards and Shrimp bycatch. Initial unconstrained models estimated “spikes” in the expectations for variable years of data across the above mentioned sources. These spikes often resulted in anomalously high levels of fishing mortality to occur at random intervals in the east area resulting in infeasible swings in area-specific abundance. By imposing a high penalty for data misfit the model was effectively constrained to fit the observed data, eliminating the spikes in  $F$  and increasing overall model stability.

Where lognormal error structures were used, annual CVs associated with each of the data sources were converted to log-scale SEs using the approximation:  $\log_e(SE) =$

$$\sqrt{(\log_e(1 + CV^2))}$$

provided in Methot et al. (2020).

Estimated parameters with no other prior implemented were given weak symmetric-beta penalty functions to keep parameter estimates from hitting their bounds (Methot et al. 2020). Parameter bounds were set to be relatively wide and were unlikely to truncate the search algorithm.

Uncertainty in parameter estimates was quantified by computing asymptotic SEs for each parameter. Asymptotic SEs are calculated by inverting the Hessian matrix (i.e., the matrix of second derivatives) after the model fitting process (Methot and Wetzel, 2013). Asymptotic SEs provide a minimum estimate of uncertainty in parameter values.

### 3.3. Estimated Parameters

In all, 2210 parameters were included in the analysis for the SEDAR 74 base model, of which 1828 were active parameters. These parameters include: year-specific (1950-2019) fishing mortality for each fleet, the stock-recruit deviations for the data-poor time period (1985-1989) the stock-recruit deviations for the data-rich time period (1990-2016), one stock-recruit relationship parameter ( $\ln(R_0)$ ), recruitment apportionment to two of the three areas (**Table 13**), size and age selectivity parameters for each relevant fleet or survey, logistic retention parameters for each fleet, catchability parameters for each index, and 31 parameters informing the Dirichlet-multinomial length and age composition weightings. Parameters were estimated in five phases. The first phase initiated initial and annual fishing mortality ( $F$ ) parameters and stock recruitment parameters (see **Table 13**). The second phase activated the base recruitment apportionment, survey catchability ( $q$ ) parameters, and Dirichlet-multinomial parameters. Base and time varying selectivity parameters were initiated in phases two and three. Time varying retention parameters became active in phase four and phase five added parameters for the early recruitment deviations and the annual recruitment apportionment deviations.

### 3.4. Diagnostics for Model Structure

Due to the uncertain nature of the data used in a Research Track Assessment only a limited number of diagnostics were completed to determine model fit. Completed diagnostics included residual analyses, correlation analyses and model sensitivity runs. Additional diagnostics will be completed during the Operational Track Assessment phase when the final data are received. Future diagnostics include likelihood profiles over key parameters, retrospective analyses, hindcasting and jitter analysis.



### 3.4.1. Residual Analysis

The main approach used to address model fit and performance was residual analysis of model fit to each of the data sets (e.g., catch, indices, length/age compositions, discards). Any temporal trends in model residuals (or trends with age or length for composition data) can be indicative of model mis-specification and poor performance. It is not expected that any model will perfectly fit any of the observed data sets, but ideally residuals will be randomly distributed and conform to the assumed error structure for that data source. Any extreme patterns of positive or negative residuals are indicative of poor model performance and potential unaccounted for process or observation error.

### 3.4.2. Correlation Analysis

High correlation among parameters can lead to flat likelihood response surfaces and poor model stability. By performing a correlation analysis, modeling assumptions that lead to inadequate model parameterizations can be highlighted. Because of the highly parameterized nature of stock assessment models, it is expected that some parameters will always be correlated (e.g., stock recruit parameters). However, a large number of extremely correlated parameters warrant reconsideration of modeling assumptions and parametrization. A correlation analysis was carried out and correlations with an absolute value greater than 0.7 were reported.

### 3.4.3. Sensitivity Runs

Sensitivity runs were conducted with the SEDAR 74 base model to investigate critical uncertainty in data and reactivity to modeling assumptions. An exhaustive evaluation of model uncertainty was not carried out, but the aspects of model uncertainty judged to be the most important for model structure and design were investigated.

Only the most important sensitivity runs are presented below, but many additional exploratory runs were also implemented. The order in which they are presented is not intended to reflect their importance; each run included here provides important information for developing or evaluating the base case model and structure. The focus of the sensitivity runs was on population trajectories, improvements in fit and important parameter estimates (e.g., recruitment).

**Time and Spatially Varying Maturity** - Two alternative versions of time and spatially varying maturity were evaluated:

1. Using separate parameter blocks for changes in  $A_{50}$  and  $A_{slope}$  over three time periods. Parameter values were fixed according to information received from the data workshop (**Table 14**).
2.  $A_{50}$  and  $A_{slope}$  as functions of Spawning Stock Biomass, representing a dynamic compensatory effect where maturity changes with stock size (i.e., fish mature at younger ages when stock sizes are low). See equation below:

$$P_y = P_{base} + P_t * E_y$$

Where, the parameter in year  $y$  ( $P_y$ ) is a base value for the parameter adjusted by a fixed effect size or scaling parameter ( $P_t$ ) multiplied by the log of the spawning biomass fraction in year  $y$ .  $P_t$  and  $P_{base}$  were calculated using a system of equations based on Data Workshop provided maturity values and model estimated spawning biomass in the associated years.

**Great Red Snapper Count (GRSC) Estimate and Selectivity** - Model sensitivity to the inclusion of the GRSC and the fleet selectivity were evaluated:

1. No GRSC estimates used in the model.
2. GRSC estimates are included in the assessment model and the selectivity is assumed to be 100% of all fish age-2+.

## 4. Stock Assessment Model - Results

### 4.1 Estimated Parameters

SEDAR 74 contained 2210 parameters with 1828 estimated with the majority of the parameters (~62%) being annual fleet-specific fishing mortality rates. Most parameter estimates and variances were reasonably well estimated (i.e.,  $CV < 1$ ). Of the active parameters, 89 had CVs exceeding 1 with most of these (58) occurring for the ascending and descending limbs of double normal selectivity functions. High CVs were also observed for portions of the recruitment distribution time series for the two areas where deviations were estimated.

### 4.2 Fishing Mortality

The exploitation rates (total biomass killed age 2+ / total biomass age 2+) for the entire stock are provided in **Table 15**. Since 1950, the exploitation rate for the stock has averaged around 0.273, and ranged between 0.043 in 1950 to 0.727 in 1983. The exploitation rate has gradually increased from low levels (less than ~0.05) to near 0.5 in the 1980s and early 1990s. It then remained elevated ranging between 0.3 and 0.5 throughout the remainder of the 1990s and early 2000s until 2005 when exploitation rate on the stock began to decline. These declines correspond with the onset of specific management actions designed to rebuild an overfished stock. Beginning in 2006 the exploitation rates declined rapidly achieving a new equilibrium around 0.15, with interannual variations, throughout the remainder of the time series. The terminal year (2019) exploitation rate for the entire stock was 0.183, which is well below the time series average of 0.273 but slightly above the average over the last decade (0.167).

**Tables 16-22 & Figures 49-50** show estimates of exploitation rates by area, fleet and year for the open season landed and discarded fish. The results show that in the west area (**Tables 16-19 & Figure 49**), exploitation for the stock was initially split fairly evenly among all sectors except for the Commercial Longline. Beginning in the 1970s the Recreational Private and Commercial Handline fisheries became the dominant west area fleets and continue to be responsible for the majority of the exploitation in this area throughout the remainder of the time series. Similar to the west area, initial exploitation in the central area was split fairly evenly among the non-Longline fleets. This pattern continued in the central area until around 1990 when the Recreational Private and Charter-For-Hire fleets became dominant in the area. Beginning around the year 2000 the Recreational Private fleet emerged as the primary source of exploitation in the central area (**Tables 17-20 & Figure 49**) and remained so throughout the rest of the time series. The Commercial Handline fleet has consistently been one of the larger contributors to total exploitation in the east area (**Figure 49**). The historic contribution of the recreational fleets is difficult to summarize in the east due to high levels of uncertainty associated with the recreational landings data in this area. However, the uptick in exploitation rate estimated for the



Recreational Private fleet in the east is supported by more robust sampling and indicates that the sector has increased in relative importance over the last decade.

**Figure 50** depicts the estimated exploitation rates by area and year for the closed season discard and bycatch only fleets. Discards have been a significant source of mortality for the Red Snapper stock since the 1970s-1980s when the Shrimp Trawling industry expanded in the GOM. Most of the Commercial Shrimp activity is in the west area which is reflected in the high exploitation rate attributed to this fleet in the area. The central and east areas both experience significant Shrimp Trawl bycatch mortality; however, in recent years the magnitude of the Recreational Private and Charter Boat sectors has increased significantly, especially for the central area. In the central area, mortality from Recreational Private discards has been estimated as the second largest source of mortality for the area for the last two decades. Similarly in the east area, Recreational Private discards are becoming an increasingly large source of mortality as the stock continues to rebuild in this area and recreational effort expands.

## 4.3 Selectivity

### 4.3.1 Length-Based Selectivity

Estimated terminal year fleet and area-specific length selectivity curves for the directed fishery and bycatch fleets are shown in **Figure 51**. In all cases closed season discard-only fleets mirror the selectivity of their equivalent open season fleets (i.e., Commercial Handline Closed Season Discards West mirrored the selectivity for Commercial Handline West). Dome shaped selectivity curves were estimated for most fleet/area combinations when double normal selectivity was imposed. However, in several instances (e.g., Recreational Private East ) the double normal parameterization estimated a form closely resembling a logistic selectivity curve. In most instances when this occurred the pseudo-logistic form was only observed for a portion of the fleets time blocks with a domed shape form occurring in the remaining time blocks. Stock Synthesis does not yet accommodate varying selectivity form by time block so in the cases where this occurred, double normal selectivity parameterizations were maintained to allow the model the flexibility to appropriately fit all available data.

As expected, the directed fisheries generally approached peak selectivity at or very near to the minimum size limit for a given time period. Notable exceptions to this were the Commercial Longline West fleet which achieved peak selectivity at sizes in excess of 60 cm for all time blocks and several of the recreational fleets particularly in the central and west areas that saw peak selectivity estimated well above the minimum size in the last time block (2000-2019) (**Figures 52-54**).

Time-varying aspects of the selectivity for each fleet and area are shown in **Figures 55-78**. In all cases, peak selectivity either remained fairly stable through time or increased to larger sizes through time. Generally speaking, those fleets that typically targeted fish larger than the minimum size (e.g. Longline fleets) had selectivity estimated as remaining nearly constant through time, while those that operated near the minimum size limit saw selectivity shift to larger sizes as regulations changed. For some fleets in some time blocks, the estimated curves were disjunct and lacked smooth transitions between length bins. It is possible that the overall complexity of the model and use of multiple selectivity time blocks led to overfitting of the selectivity parameters. Fixing some additional parameters or the application of appropriate priors

on poorly estimated parameters should be considered in future Operational Track Assessments. Furthermore, the application of spline selectivity forms should also be considered as these could both reduce the number of estimated parameters as well as limit the ability of the model to overfit the composition data.

Estimated terminal year fleet and area-specific length selectivity curves for the surveys of abundance are shown in **Figure 79**. The video surveys were estimated to reach peak selectivity around 40-45 cm depending on area but were also estimated to be highly selective for fish as small as 25-30 cm. The Central GOM Combined Video Survey was the only survey with a time varying component (**Figure 80**). Estimated selectivity across time blocks for the central area video survey were very similar with only slight adjustments to the changes in survey design (i.e., selecting for smaller fish as survey design changed through time). Time blocks for the video survey were maintained in the final model but could be considered for removal during subsequent Operational Track Assessments. Selectivity for the Summer Trawl survey was modeled using a 3-node cubic spline function. Estimated parameters for these fleets produced sharply dome shaped fits with peak selectivity occurring at very small sizes (~15-20 cm) and then rapidly declining toward zero selectivity between 40-50 cm. Fits to the west area Early Fall Trawl Survey, and all areas of the Shrimp Trawl bycatch (**Figure 81**) were estimated as expected by the negative slope logistic parameterization. Selectivity peaked near 0-10 cm FL and then declined rapidly toward 0 selectivity by around 30 cm FL. The Commercial Reef Fish Observer Program was mirrored to the selectivity of the Commercial Handline fleet to reduce estimated parameters. Length composition data specific to this survey was available; however, it was not shown to differ from the fleet enough to warrant separate selectivity estimation.

### 4.3.2 Age-Based Selectivity

Selectivity fits for the three surveys modeled using age composition are shown in **Figure 82**. The central and west area fits were similar for the Bottom Longline Survey with both estimating 50% selectivity around ages 6-7 and maximum selectivity around ages 8-9. The east area Bottom Longline Survey was estimated to select for slightly younger fish with 50% selectivity around age-5 and maximum selectivity achieved around age-7. Differences in gear selectivity by area for this survey would primarily be attributable to differential age-class availability given uniform gear and survey design across areas. Estimated selectivity for the post 2007 Fall Trawl Survey was similar across areas, with fixed maximum selectivity at age-0 and then declining rapidly until selectivity was fixed at 0% for all age-4+ fish (**Figure 82**).

The GRSC Survey of absolute abundance was unique in that it was only operational for a single year in the assessment model (2018) and did not incorporate composition data. Selectivity was fixed in the east area with 0% selectivity for age-0 and age-1 fish and 100% selectivity for all age-2+ fish. This decision was reached through panel discussion and review of the proposed GRSC study design. Selectivities in the central and west areas were fit using double normal parameterizations and both curves were estimated to have domed-shaped selectivity with nearly 100% selectivity for ages 2-10 with selectivity gradually declining in both areas approaching approximately 30% selectivity in the west and 20% selectivity in the central area for age-20+ fish (**Figure 82**). It is unknown whether these estimated selectivity patterns actually represent the true selectivity of the survey in the central and west areas due to the lack of adequate composition data. It is likely that the model simply converged on a solution that resulted in the

maximum reduction in the likelihood penalty for the survey abundance. Sensitivities around this assumption of selectivity were carried out and are detailed in section 4.8.6.

## 4.4 Retention

Length-based, time-varying retention functions by time block are provided for each directed fleet and are shown in **Figures 83-97**. Most retention parameters appeared well estimated except for a few of the Commercial Longline parameters estimated with CVs in excess of 1: the slope and asymptote parameters for the central area 2007 time block and the 2007 time block slope parameter for the west area. The model estimated that a number of fleets were discarding a substantial amount (>20%) of legal sized fish from 2007-2019 (see **Figures 98-124** for terminal year length-based retention for all fleets). For the commercial sector, the Handline East fleet (**Figure 100**) and all three areas of Longline fleets (**Figures 101-103**) had asymptotic retention below 80% with the Longline fleets in the east and central area estimated to discard approximately 50% of legal sized catch. High-grading and/or regulatory discards were also estimated to occur in the 2007-2019 time block for the central and east areas Recreational Charter Boat and Recreational Headboat-for-hire fleets. In both the central and east areas, Charter boats were estimated as discarding around 20-30% (**Figures 105 & 106**) of legal-sized fish while Recreational Headboats were estimated to discard roughly 40% (**Figures 107-109**). Of the Recreational Private fleets, the east area fleet was estimated to discard approximately 30% of legal sized catch while the central and west area fleets retained nearly all caught fish.

## 4.5. Recruitment

As noted in the description of the SS model configuration, two of the three S/R parameters were fixed: steepness (0.99) and  $\sigma R$  (0.6). Steepness was fixed as a computational convenience and  $\sigma R$  was fixed at a recommended value for model stability. The corresponding Beverton-Holt stock recruit curve is shown in **Figure 125**. Estimated annual recruitment of age-0 fish (1000s) from 1990-2016 including recruitment deviations and variance are shown in **Tables 23-25** and **Figures 126-127**. Virgin recruitment in log-space ( $\ln(R_0)$ ) was estimated at 11.354, which equates to 85.26 million age-0 Red Snapper. The estimated (and applied) recruitment bias adjustment ramp is shown in **Figure 128**.

During the main recruitment period (1990-2016, see **Section 3.1.5**), estimated recruitment averaged 118.81 million Red Snapper and was lowest in 2008 at 34.38 million Red Snapper and highest in 2015 at 205.65 million Red Snapper (**Figure 129**). Recruitment deviations were characterized by a generally upward trend from the 1980s to present with reasonable interannual variations. There was a noticeable drop in recruitment in 2008 (an 80% drop from the previous year), which coincides with low, but not abnormally so, index values across all areas for the 2008 Fall Trawl Survey which predominantly indexes age-0 Red Snapper and the 2009 Summer Trawl Survey, which predominantly indexes age-1 Red Snapper (**Figures 12-14**).

Estimated base recruitment apportionment placed 72%, 22% and 6% of recruits into the west, central and east areas, respectively (**Figure 129**). These percentages were applied from 1950 until 1973 after which annual deviations were estimated and applied resulting in variable recruitment across the areas. In general, mean apportionment remained around the base values until the early 1990s after which the central area received a gradually increasing proportion of the total recruitment at the expense of the west area which saw its share of total recruitment

decline. By the end of the time series, the average apportionment from 2010-2019 was 58%, 31%, 11% for the west, central and east areas, respectively. Recent estimated apportionment is likely more appropriate for use in forecasting. Care must be taken to ensure the apportionment values are applied during the Operational Track Assessment since the SS default is to apply the base values in projections. Apportionment deviations were generally well estimated with moderate levels of interannual variability and no area-specific recruitment failures present.

CVs for recruitment deviations during the main recruitment period averaged 0.096 between 1990 and 2016, and ranged from 0.066 in 2009 to 0.14 in 2008 (**Figure 127**). For the last two years of the assessment (2018, 2019), recruitment deviations were largely informed by the age-0 index, as age-0 and age-1 fish had not yet fully recruited to the fisheries. Estimated recruitment for those terminal years were at or slightly above average but not dissimilar from the immediately preceding years. Their estimated values and associated CVs were 179.694 million Red Snapper (CV=0.091) and 122.854 million Red Snapper (CV=0.138), respectively.

#### 4.6. Biomass and Abundance Trajectories

The estimated annual total biomass (metric tons), exploitable biomass (age-2+, metric tons), SSB (metric tons), SSB ratio (SSB/virgin SSB) and exploitable abundance (1,000s of fish) from 1950 to 2019 are provided in **Tables 23-25**. Total biomass was consistently greater in the west area than in either the central or east areas and averaged 59,811 metric tons, and ranged from 8,633 metric tons in 1988 to 171,571 metric tons in 1950 (**Figure 130**). West area exploitable biomass and numbers, which comprised Red Snapper age-2 or older, averaged 55,298 metric tons and 19,368,888 Red Snapper, respectively. Exploitable biomass in the west was lowest in 1990 at 5,240 metric tons and peaked in 1950 at 167,041 metric tons, whereas exploitable numbers in the west ranged from 4,110,250 Red Snapper in 1990 to 47,482,100 Red Snapper in 1950 (**Table 23**). West area SSB averaged 53,274 metric tons, and ranged from 4,894 metric tons in 1989 to 163,037 metric tons in 1950 (**Figure 131**).

Total biomass in the central area averaged 18,030 metric tons, and ranged from 2,954 metric tons in 1989 to 37,723 in 1955, (**Figure 130**). Central area exploitable biomass and numbers, which comprised Red Snapper age-2 or older, averaged 15,910 metric tons and 7,475,271 Red Snapper, respectively. Exploitable biomass in the central area was lowest in 1990 at 1,818 metric tons and peaked in 1955 at 36,277 metric tons, whereas exploitable numbers in the central ranged from 1,248,010 Red Snapper in 1990 to 19,334,700 Red Snapper in 2018 (**Table 24**). Central area SSB averaged 15,312 metric tons, and ranged from 1,795 metric tons in 1995 to 35,723 metric tons in 1955 (**Figure 131**).

Total biomass in the east area averaged 3,795 metric tons, and ranged from 103 metric tons in 1992 to 10,674 in 1952, (**Figure 130**). East area exploitable biomass and numbers, which comprised Red Snapper age-2 or older, averaged 3,528 metric tons and 1,331,770 Red Snapper, respectively. Exploitable biomass in the east area was lowest in 1992 at 81 metric tons and peaked in 1952 at 10,341 metric tons, whereas exploitable numbers in the east ranged from 52,344 Red Snapper in 1992 to 3,424,380 Red Snapper in 2018 (**Table 25**). East area SSB averaged 3,425 metric tons, and ranged from 76 metric tons in 1992 to 10,170 metric tons in 1952 (**Figure 131**).

In all three areas total biomass and SSB show a steady decline from 1950 to the late 1980s, followed by a plateauing off in the 1990s to early 2000s. Starting in the mid 2000s, biomass began to rapidly recover across all three areas with the onset of management actions aimed at rebuilding the stock. Biomass and SSB growth in the west has continued in a near linear fashion from 2005 (**Figure 130**) to 2019 and is estimated to be at its highest post-crash abundance in the assessment terminal year. Biomass recovery in the central and east areas was estimated to have occurred at a somewhat faster rate than in the west up until 2010 when biomass was estimated to have stabilized or even declined slightly in both areas (**Figure 130**). However, the rate of recovery in the east and central areas has increased in recent years with several large year classes entering the stock. Like biomass in the west area, central and east area biomass are at their highest estimated post-crash level in the terminal year (2019).

Initial depletion in 1950 ( $SSB/SSB_0$ ) was estimated to be 0.78 in the west area while the central and east areas were estimated to be at 0.46 and 0.43, respectively (**Tables 23-25 & Figure 132**). SSB ratios in all areas declined rapidly from 1950 falling below the current overfished limit of 0.26 in 1974 for the west, 1970 for the central area and 1965 for the east. Stocks are on an upward trajectory in recent years with the terminal 2019 SSB ratios estimated to be 0.24, 0.30, and 0.21 for the west, central and east areas, respectively. GOM wide trends in SSB ratio follow a similar pattern to the area-specific trends with the highest estimated ratio occurring in 1950, bottoming out in 1989 at 0.023 and then increasing rapidly beginning in 2005.

## 4.7. Model Fit and Residual Analysis

### 4.7.1. Landings

Landings for all areas and all fleets were fit almost exactly prior to 1995 given their relatively small SEs (**Figures 133-135**). After 1995, the Data Workshop participants recommended SEs were used across all fleets and areas and allowed more flexibility in the fit to the landings (**Tables 26-40**). Despite the increased uncertainty in the landed data, fits generally remained good without signs of extreme variability or directional bias. The upweighting lambda applied to the Recreational Private fleet in the east forced the model to closely fit the observed data as expected (**Figure 135**). Some spiking in the expected landings of the east area Charter Boat fleet were observed in the final model fit. However, the magnitude of these errant fits (~40,000 fish in the most severe case) were not deemed large enough to warrant further model restriction through additional weighting factors.

### 4.7.2. Discards

The time series of commercial discards began in 1995 for all fleets and all areas. Observed and expected values are shown in **Tables 41-67 & Figures 136-138**. Discards from the Commercial Handline fleets historically made up a significant part of the total catch for the west and central areas, but have been greatly reduced since the onset of the IFQ program in 2007 (**Figures 136-137**). Commercial Longline discards in the central and west area are low throughout the time series and contribute little to the total catch of Red Snapper in the GOM (**Figure 8**). Fits to all commercial open and closed season discard fleets in the west and central areas are good with reasonable deviations and no apparent systematic biases. Commercial discards in the east follow a different pattern than the central and west areas and show some model fit issues particularly in the later part of the time series. Both the Handline and Longline fleets in the east produced very



few open season discards historically but have seen those increase in recent years (**Figure 138**). However, when taken on aggregate with the closed season discards, total discards for the east area commercial fleets have remained fairly stable throughout the time series. Model fits were reasonably good for the east area commercial open and closed season discards until 2014 and 2018 for the Handline and Longline fleets, respectively. After which, expected discards exceed observed discards for all remaining years by a significant margin. The upweighting lambda applied to the closed season Handline discards in the east forced the model to closely fit the observed data as expected (**Figure 138**). Despite the few noted misfit issues, commercial discards are in general well estimated given the high levels of uncertainty associated with the data and lack of robust composition samples throughout most areas and years.

Recreational open season discards beginning in 1981 or 1982 depending on fleet and area. Open and closed season discards begin to be separated out and modeled separately around 1997 for most fleets except the Headboat fleets for which the calculation was not possible. The model was able to fit discard observations relatively well throughout the time series for recreational fleets (**Figures 136-138**). For the Headboat west fleet the model greatly overestimated the expected discards from 1990 to 1994 indicating a possible misspecification of the retention blocking for this time-period (**Figure 137**). All other open and closed season recreational discard fleets were fit well with no apparent systematic bias or excessive variability. The upweighting lambda applied to the Closed Season Recreational Private discards in the east forced the model to more closely fit the observed data; however, the fit was not perfect with the 2011 estimate still exceeding the observed value by a substantial, but acceptable amount. (**Figure 138**).

### 4.7.3. Indices

Across all three assessment areas, fits to the relative indices of abundance were generally good (**Tables 68-81 & Figure 12-14**). In the west, fits to the observed indices of the exploitable age range of the population (age-2+) were acceptable with RMSE ranging from 0.32 to 0.56 (**Figure 12**). Fits to the west area trawl surveys, which predominantly index age-0 (Fall, **Tables 68 & 69**) and age-1 fish (Summer, **Table 72 & 73**) Red Snapper were good, and had RMSEs ranging from 0.179 to 0.358. In general, the expected fits to the west area indices matched the observed increase in biomass beginning around 2010 and captured the strong year classes observed in the age-0 Fall Trawl survey. Fits to the relative indices of abundance in the central area were acceptable though generally did not fit as well as the west area indices (**Figure 13**). In particular, the fit to the Larval Survey was poor with a RMSE of 0.908 (**Tables 76-77**). This was likely more a result of the highly uncertain and variable nature of the index rather than pathological model issues. The remaining indices fit well with RMSE ranging from 0.331 to 0.518. Fits to the east area indices of abundance also were generally good (**Figure 14**). High RMSE values of 0.998 and 0.734 were estimated for the east area summer trawl late and bottom longline surveys, respectively. The remaining east area surveys had RMSE estimates of between 0.27 and 0.441.

Fits to the GRSC survey varied widely by area. In general the model as configured fit the GRSC estimates of abundance for the western and central GOM areas reasonably well, but did not fit the GRSC estimate for the eastern area (**Figure 15 & Tables 82-84**). In the west and to a lesser extent central areas, the model derived area-specific abundances largely agreed with the estimate obtained from the snapper count and the resulting fits, while the RMSE values were reasonable. However, in the east the model estimated a substantially lower abundance for the area than was obtained from the GRSC resulting in poor overall fit and large RMSE of 2.155. An exploratory

model run was completed that used upweighted likelihood penalties to effectively force the model to fit to the GRSC estimate in the east. Results of this run showed improved fit to the GRSC survey which came at the expense of degraded fits to the discard and length composition data (**Figure 139**) as well as fits to the east area Bottom Longline and Commercial Reef Fish Observer indices of abundance (**Figure 140**).

#### 4.7.4 Shrimp Trawl Effort and Bycatch Data

Fits to the Shrimp Trawl effort time series and bycatch data are shown in **Figures 11 and 10**. Generally, fits to the effort and bycatch were good across all areas with low RMSE for the effort series and reasonable fits for the bycatch superperiod. The upweighting lambda applied to the Shrimp Trawl bycatch in the east forced the model to closely fit the observed data. Initial unconstrained estimates for the bycatch in the east resulted in greatly elevated expected bycatch for the area, necessitating the use of a weighting factor.

#### 4.7.5. Length Compositions

Model fits to the retained length composition data are provided in **Figures 16-30**.

Model fits to the discard length composition data are provided in **Figures 141-144**.

Model fits to the survey length composition data are provided in **Figures 31-48**.

Model fits to the Shrimp Trawl bycatch length composition data are provided in **Figures 40-42**.

The aggregate fits to the length composition data were acceptable across all fleets and surveys (**Figure 145**), with only a few low sample size fleets showing signs of misfitting. Pearson residuals for length composition fits are provided in **Figure 146** are generally small in magnitude and un-patterned. However, some residual patterns were present in the Handline Central (HL\_C retained) and Charter Boat Central (CBT\_C retained) fleets and indicate a possible retention or selectivity mis-specification in the 2007-2019 time-block for the Handline fleet and in the 1995-2006 time-block for the Charter Boat fleet. There was no a priori evidence in discussions with fishers to suggest that the Commercial Handline central and Recreational Charter Boat central fleets should follow different retention blocks. Thus the decision was made to maintain the specified blocks rather than chase potential noise in the data.

#### 4.7.6. Age Compositions

Model fits to the age composition data are provided in **Figure 147**. Generally, the model fit the age composition well however there was a residual pattern observed for the Bottom Longline East Survey (**Figure 148**). Patterns in the east Bottom Longline fits are likely due to low composition sample sizes resulting in truncated age distributions for most years.

### 4.8. Model Diagnostics

#### 4.8.1. Correlation Analysis

A summary of correlations for the base model parameters considered as outliers is contained in **Table 85**. Given the highly parameterized nature of this model, some parameters were mildly correlated (correlation coefficient >70%) and eight combinations of selectivity parameters

displayed a strong correlation (>95%; **Table 86**). Correlation among many of these parameters is not surprising, especially for the selectivity parameters, because the parameters of selectivity functions are inherently correlated (i.e., as the value of one parameter changes the other value will compensate). The decision was made not to fix highly correlated parameters as part of the Research Track Assessment, given that the data are influx and correlations may shift as the data is updated for the Operational Track Assessment. The strongest correlations occurred between the parameters defining the peak and the width of the ascending and/or descending limb of the double normal selectivity functions for some fleets.

#### 4.8.2. Sensitivity Model Runs

Results for the sensitivity runs summarized in **Section 3.4.3** are discussed below. Making use of time-blocked or SSB linked maturity had a moderate impact on model estimates of spawning biomass (**Figure 149**). Use of time-varying maturity (blocks or linked to SSB) resulted in reduced estimates of virgin SSB and slightly increased estimates of SSB throughout most of the time series. The combination of lower SSB<sub>0</sub> values and higher terminal year SSB resulted in about a two point difference in SPR between the base case and the time-varying cases (**Figure 150**). Neither approach was preferred to the base model constant maturity assumption due to uncertainty around the implication of time-varying maturity on the projections.

Sensitivity models looking at the GRSC showed that the choice of selectivity made very little difference on derived model quantities. The base selectivity options and the sensitivity using fixed 100% selectivity for all age-2+ fish had nearly identical SSB estimates and consequently similar patterns of depletion (**Figure 150**). On the other hand, removal of the GRSC survey altogether resulted in noticeable declines in estimated SSB in the later years of the model and a roughly 5% drop in terminal year depletion.

### 5. Discussion

The SEDAR 74 Red Snapper Research Track Assessment encompassed a complete re-evaluation of all aspects of the Gulf of Mexico Red Snapper stock assessment enterprise. This collective effort spanned multiple years and could not have been completed without the dedicated work of countless private, academic, state and federal stakeholders from all corners of the southeastern United States. SEDAR 74 is the culmination of that work, and represents the most complex and ambitious stock assessment model developed in the Southeast region to date. First, as part of this process the stock ID was re-evaluated and changed from a two-area to a three-area metapopulation model. Secondly, every source of available data from life history, commercial and recreational catch and discard statistics, discard mortality rates, composition databases, surveys of relative and absolute abundance and environmental covariates were compiled, updated to conform to current best practices and reconsidered for inclusion in the model. Lastly, the model was critically evaluated throughout development in public forums by a panel of regional Red Snapper and fishery science experts. The true value of this endeavor will only be known once the assessment model becomes operational and is evaluated for use in management. However, from a strictly model development perspective, a number of significant advancements were achieved.

SEDAR 74 made many changes to the model structure when compared to the most recently accepted assessment model (SEDAR 52). Among the most significant of these were the change



to a three-area stock ID, switching from MRIP Coastal Household Telephone Survey (CHTS) based recreational statistics to Fishing Effort Survey (FES) based statistics, the inclusion of an independently derived index of absolute abundance, and adopting length-based instead of age-based selectivity for the directed fleets. In addition to the major changes in model structure that accompanied the update in stock ID, this Research Track Assessment also implemented various new procedures and methodologies for GOM Red Snapper including: utilizing the Dirichlet-multinomial likelihood for composition data, utilizing unconstrained (i.e., no zero sum penalty) recruitment deviations to account for unknown causes of shifts in population productivity, revisiting the Then et al. (2015) approach to estimating natural mortality by subsetting data to the family level, and switching to spawning stock biomass, as a proxy for reproduction, rather than total egg production based on the most recent data provided by the Life History Working Group.

During the Stock ID Workshop the decision to move forward with a three-area model was in no way unanimous. One approach proposed during the Stock ID process was a two-area stock structure with a dividing line located at the DeSoto Canyon which is located at the shelf edge roughly south of the Florida/Alabama border. Requests for the Research Track Assessment to develop both three-area and two-area models were considered but ultimately rejected due to the time it would take for both the data compilers and the assessment team to accommodate the request. It is impossible to know with certainty how the two-area model would have performed relative to the final three-area model. However, from a GOM wide perspective, metrics like initial depletion, biomass trajectories, and terminal year depletion did not differ greatly between the three-area SEDAR 74 model and the previously accepted two-area SEDAR 52 model. This makes some intuitive sense when one considers that the totality of the data is quite similar between the two model configurations. Thus, it is likely that GOM wide, the current three-area model and the hypothetical two-area model proposed during stock ID would have exhibited similar biomass, depletion, reference point and stock status metrics. The advantage of the three-area model is that it allows regions of the GOM with different fishery and population dynamics to be modeled and subsequently monitored independently. The ability to monitor the population at finer scales will allow for more responsive Red Snapper management at the federal and state levels.

The switch to recreational statistics based on the FES represents current best practices for handling estimates of recreational landings and discards in the southeast United States. However, numerous concerns have been raised regarding the accuracy of the FES based estimates, particularly for Red Snapper where estimates of recreational statistics derived from state run surveys exist and tend to differ substantially from FES estimates. Research efforts are underway to better understand potential biases in the FES survey design as well as explore the use of state collected data for assessment purposes. There are numerous advantages for the states to operate the surveys collecting recreational catch data for Red Snapper and other managed species in their coastal waters. These include, among others, allowing the states to be more responsive to in-season management needs, being able to better tailor the surveys to the specific conditions and needs of the states' fisheries, and leveraging local knowledge and relationships to promote stakeholder engagement and participation. While great promise exists for the state run surveys, there are a number of challenges prohibiting their adoption as the preferred source of recreational removals in stock assessment. Paramount among these is the length of time most surveys have been operating and the collection of discard data. Current MRIP estimates for recreational landings go back to 1981 and historic extrapolations of landings can be generated back to 1955.

Many of the state run surveys have been active for less than a decade and have no known way of generating reliable estimates of prior landings that are independent from the federally collected MRIP data. In addition, the state surveys do not have uniform statistical survey designs among them which creates calibration issues among the surveys that must be resolved before they can be used for GOM wide assessment purposes. While these issues are substantial they are not necessarily insurmountable, and federal and state agencies responsible for fisheries data collection must continue to conduct collaborative research in order to resolve the remaining issues and ensure that the highest quality data is available for Red Snapper assessment and management in the future.

The Great Red Snapper Count (GRSC) was an unprecedented study in the GOM which provided invaluable insight on the abundance and distribution of GOM Red Snapper. Incorporating an absolute abundance study like the GRSC into an assessment had never been attempted in the GOM and required a number of methodological decisions and assumptions to be made around the catchability coefficient ( $q$ ), data weighting, and selectivity. Given that the study's stated goal was to produce an index of absolute abundance, the base assumption for  $q$  was to fix it at one for all areas. Allowing the model to estimate  $q$  for the surveys resulted in perfect fits to the survey abundance with no change in area-specific or GOM wide abundance. In other words, estimating  $q$  essentially allowed the model to reduce the impact of the survey in favor of other data sources, and was therefore rejected in favor of the fixed  $q$  approach.

During model development, a number of different data weighting schemes were attempted to see how the base model would respond when forced to fit the GRSC estimates more or less closely. As weights on the GRSC survey were decreased the model simply converged back to the result achieved with no GRSC survey included. Increasing weights led to tighter fits in the west and central region where the base model fits were already reasonably good. The east area, which shows the greatest lack of fit in the base model, responded only slightly to the increased weights. Ultimately, the Assessment Development Team decided that the GRSC indices of abundance should be given equal weight to all other sources of data.

The lack of fit in the east area suggests that there are substantive and data-supported differences between the model-derived estimate of east area abundance and the GRSC-derived estimate of east area abundance. It was noted during review of the GRSC study that the overwhelming majority of Red Snapper observed in the east area appeared to be from a single strong year class that had likely not yet fully recruited to the fisheries. Given a terminal data year of 2019, this year class was not fully represented in the landings and composition data available for the Research Track Assessment. Thus, it remains possible that the disconnect between the GRSC and assessment based estimates of east area abundance will resolve as additional years of data are incorporated into future assessments. Further exploration into this conflict between the GRSC estimates of area-specific abundance and the comparable model based estimates is clearly warranted for future assessments.

Fitting the GRSC abundance estimates required selectivity assumptions be made for each area as there was not an adequate amount of survey associated composition data available for the model. The GRSC specifically set out to estimate abundance for age-2+ Red Snapper which made fixing selectivity at 100% for all age-2+ Red Snapper a logical assumption. However, in practice differences in area-specific sampling designs and gear application led the Assessment Development Team to conclude that it was probable, if not likely, that the central and west area

components of the survey achieved less than 100% selectivity for all age-2+ fish. Therefore the decision was made to model selectivity for the central and west using double normal parameterizations. This decision was not without risk as the efficacy and value of estimating selectivity curves in the absence of composition data is debatable. Nonetheless, sensitivity runs around the decision indicated the final choice of selectivity for the survey was not overly influential, supporting the base model configuration of fixed selectivity in the east and estimated in the central and west areas.

The decision to use length composition data to model the selectivity of the directed fishing fleets differs from previous Red Snapper assessments that relied solely on age composition data. Previously, age composition was used out of necessity as the modeling framework was age-structured and incapable of accepting length composition data as an input. Advancements in the SS model framework now allow length composition data to be easily incorporated into the model as a stand alone composition data source or along with age composition data. SEDAR 74 opted to rely on length composition for the directed fleets to facilitate the simultaneous fitting of landed and discard fish, as retention functions were length-based. Previous Red Snapper models had experienced difficulty modeling the discarding process due to inherent conflicts between the externally estimated and fixed growth curve, fixed length-based retention curves, and the estimated age composition of the landed fish. Essentially, in fitting the more robust, age-based landings composition the model was unable to select enough young and therefore small fish to fit the observed discard data. Allowing both the selectivity and retention process to work in the same compositional units appears to have successfully alleviated that issue for SEDAR 74 as fits to discard and landing data have generally improved. However, the shift to length composition sacrifices some of the robust cohort tracking information that is often contained in age composition data. For SEDAR 74 age composition for a number of the fishery-independent indices of abundance were included to provide needed information on year class strength. Several Gulf of Mexico assessments have included both age and length composition data for some fleets with mixed results. In most cases tension between the two compositional data sources exists resulting in degraded fits to both. Incorporating both age and length composition for the same fleet/survey could be explored in future Red Snapper assessments, but was not attempted as part of SEDAR 74.

During model development and review a number of data issues were observed that should be considered for the upcoming Operational Track Assessment. MRIP derived estimates of Recreational Private landings, regardless of FES or CHTS survey design, produce highly variable and inconsistent estimates of Recreational Private landings in the earliest few years of the time series for all assessment areas (1981-1985; **Figure 6**). These estimates have long been considered anomalies with the 1981 and 1983 landings data specifically singled out in the SEDAR 74 recreational statistics working paper (SEDAR 74-DW-01). Other recent Gulf of Mexico assessments have dealt with similar issues by replacing anomalous landings data with an average value derived from adjacent years or substituting reasonable alternatives if adjacent year landings are also suspect or missing. It is strongly suggested that these data should be re-evaluated during the upcoming Operational Track Assessment given the issues they cause with the fitting of the landings and discards as well as their influence on the estimation of the historical recreational landings.

Estimates of the Recreational Private discards in the east area were highly variable with most years observing low levels of discarding punctuated by a few extremely high estimates that were

largely attributed to the closed season fleet (**Figure 9**). These dynamics are almost certainly the result of sample size issues rather than a reflection of actual fleet dynamics in the east area. The model would benefit from having these points addressed as they resulted in fit issues throughout model development as well as high  $F$  estimates that caused noticeable and implausible shifts in the east area-specific biomass (**Figure 130**). Approaches like those proposed for the landings data issues could be applied here. Correcting this issue would likely eliminate the need to use a data weighting factor to constrain the Recreational Private east closed season discard fleet and may generally improve fit to all sources of data in the east area.

Finally, the decision to use unconstrained (non-zero summed) recruitment deviations as opposed to a parameterized regime shift and penalized recruitment deviations, used in previous Red Snapper assessments resulted in similar and sensible trends in Red Snapper recruitment. This decision reduced the number of estimated parameters in the model and allowed recruitment to be informed by the data rather than a model structure decision. Despite the model structure change, trends in recruitment generally increased over time as expected given changes in observed landings and catch per unit effort (CPUE). The average trend in recruitment appeared to begin to stabilize in the early 2000s likely as a result of effective management and a recovered spawning population. In contrast to the generally positive trend in recruitment is the relatively low estimate of recruitment in 2009. It's unclear what may have caused the estimated recruitment failure in 2009, indicated by the dip in the Summer Trawl index. Hurricane Ike traveled through the GOM during September of 2008 eventually making landfall in Texas. This corresponds with peak Red Snapper spawning and may have played a role in disrupting settlement; however, GOM hurricanes are not uncommon with many others occurring during the assessment time period without noticeable impacting recruitment. Continued investigation into environmental impacts on the Red Snapper population is warranted.

## 6. Acknowledgements

The SEDAR74 Research Track Assessment for Gulf of Mexico Red Snapper would not have been possible without the efforts of the numerous state, NMFS, SEFSC, SERO, and GMFMC staff along with the many academic and research partners involved throughout the Gulf of Mexico. The following agencies contributed to the assessment and deserve notable attention and thanks for efforts extended to developing data inputs: NOAA SEFSC Fisheries Statistics Division (FSD), NOAA SEFSC Gulf Fisheries Branch of the Sustainable Fisheries Division, NOAA SEFSC Panama City Laboratory, University of Florida, NOAA SEFSC Mississippi Laboratories, NOAA Southeast Regional Office (SERO), Harte Research Institute and the whole GRSC team, LGL Ecological Research Associates, Florida Fish and Wildlife Conservation Commission, Fish and Wildlife Research Institute, Alabama Department of Conservation and Natural Resources, Mississippi Department of Marine Resources, Louisiana Department of Wildlife and Fisheries, Texas Parks and Wildlife Department, Cooperative Institute for Marine and Atmospheric Studies, and the Gulf States Marine Fisheries Commission. Special thanks are also extended to the assessment development team as well as all participating members of the Stock ID, Data, Assessment and Review Working Groups for their assistance and guidance throughout the process. Special thanks are extended to Dr. Richard Methot and team for continued discussions and modifications to the Stock Synthesis model. Thanks are extended to Dr. Skyler Sagarese, Dr. Francesca Forrestal, and Dr. Lisa Ailloud for developing R code to implement the Markdown versions of the majority of the tables and figures.

## 7. Research Recommendations

Recommendations for considerations of future research are provided below in no particular order of priority.

### Recreational Landings and Discards data

- Further develop best practices for correcting for prominent peaks and troughs in the earlier part of the time series where uncertainty is high and catch/discard estimates are driven by few but influential intercept records.
- Investigate influence of depredation as a contributor to discard mortality and its significance on observed discard data used in the assessment.

### Composition Data Alternatives

- Incorporating age composition and length composition data for the directed fleets and estimating growth internally to the model to facilitate fit of multiple simultaneous sources of composition data.
- Consider the application of conditional age-at-length data for use in red snapper stock assessment.

### Alternate Start Years

- SEDAR 74 moved the model start year from 1872 to 1950, but other later years would have been considered if not for modeling limitations. The determining factor in selecting 1950 was the shrimp bycatch data and the lack of an ability to specify an initial  $F$  for a bycatch only fleet. This issue should be further explored and possible modifications to SS should be considered to allow the consideration of later start years.

### Additional Data Needs

- Currently the model includes length-converted age composition data for surveys, where possible. It would benefit the model to include real age composition for trawl surveys in the future.
- Incorporating recreational discard composition into the east assessment area.
- Investigate the impact of using state survey derived landing statistics on the assessment model.

## 8. References

- Dichmont, CM, RA Deng, AE Punt, J Brodziak, YJ Chang, JM Cope, JN Ianelli, CM Legault, RD Methot, CE Porch and MH Prager. 2016. A review of stock assessment packages in the United States. *Fisheries Research* 183:447-460.
- Francis RICC, RJ Hurst and JA Renwick. 2003 Quantifying annual variation in catchability for commercial and research fishing. *Fishery Bulletin* 101(2):293-304.
- Francis RICC. 2011. Data weighting in statistical fisheries stock assessment models. *Canadian Journal of Fisheries and Aquatic Sciences*. 68:1124-1138.
- Hulson P-J, D Hanselman, and T Quinn. 2012. Determining effective sample size in integrated age-structured assessment models. *ICES Journal of Marine Science*, 69:281-292.
- LGL Ecological Research Associates, Inc. 2022. Estimation of Total Red Snapper Abundance in Louisiana and Adjacent Federal Waters. Louisiana Department of Wildlife and Fisheries, Baton Rouge, LA. 112 pp.  
[https://www.wlf.louisiana.gov/assets/Resources/Publications/Saltwater\\_Fish/LDWF-Abundance-of-Red-Snapper-Final-Report-Package-25-March-2022.pdf](https://www.wlf.louisiana.gov/assets/Resources/Publications/Saltwater_Fish/LDWF-Abundance-of-Red-Snapper-Final-Report-Package-25-March-2022.pdf)
- Linton, B. 2012. Shrimp fishery bycatch estimates for Gulf of Mexico red snapper, 1972- 2011. SEDAR31-DW30.
- Lorenzen K. 2000. Allometry of natural mortality as a basis for assessing optimal release size in fish-stocking programmes. *Canadian Journal of Fisheries and Aquatic Sciences* 57(12):2374-2381.
- McCarthy, K. 2013. Calculated discards of gray triggerfish and blueline tilefish from US South Atlantic commercial fishing vessels. SEDAR32-DW-11. 17 pp.
- McCarthy, K. 2015. Discards of Red Snapper Calculated for Commercial Vessels with Federal Fishing Permits in the US South Atlantic. SEDAR41-DW36. 18 pp.
- Methot RD and IG Taylor. 2011. Adjusting for bias due to variability of estimated recruitments in fishery assessment models. *Canadian Journal of Fisheries and Aquatic Sciences*, 68(10):1744-17.
- Methot RD and CR Wetzel. 2013. Stock synthesis: a biological and statistical framework for fish stock assessment and fishery management. *Fisheries Research* 142:86–99.
- Methot RD, CR Wetzel, IG Taylor and K Doering. 2020. Stock Synthesis User Manual Version 3.30.16. NOAA Fisheries, Seattle Washington. 225 pp.
- Nance, J. 2004. Estimation of effort in the offshore shrimp trawl fishery of the Gulf of Mexico. NOAA Southeast Fisheries Science Center, Galveston Laboratory. SEDAR7-DW24. SEDAR, North Charleston, SC.
- Punt, A.E., Smith, D.C., Krusic-Golub, K., and Robertson, S. 2008. Quantifying age-reading error for use in fisheries stock assessments, with application to species in Australia's

- southern and eastern scalefish and shark fishery. *Canadian Journal of Fisheries and Aquatic Sciences* 65: 1991-2005.
- SEDAR (Southeast Data, Assessment, and Review). 2018. SEDAR 52 – Gulf of Mexico Red Snapper Stock Assessment Report. SEDAR, North Charleston SC. 434 pp. Available online at: <https://sedarweb.org/documents/sedar-52-gulf-of-mexico-red-snapper-final-stock-assessment-report/>.
- SEDAR (Southeast Data, Assessment and Review). 2021. Gulf of Mexico Red Snapper Stock ID Process Final Report. SEDAR, North Charleston SC. 87pp. Available online at: <https://sedarweb.org/documents/sedar-74-gulf-of-mexico-red-snapper-stock-id-process-final-report/>.
- SEDAR (Southeast Data, Assessment and Review). 2022. Gulf of Mexico Red Snapper; SECTION III: Data Workshop Report. SEDAR, North Charleston SC. 225pp. Available online at: <https://sedarweb.org/documents/sedar-74-gulf-of-mexico-data-workshop-report/>.
- SEDAR 74 Discard Mortality Ad-Hoc Working Group. 2023. Final Report of the SEDAR 74 Ad-hoc Discard Mortality Working Group for Gulf of Mexico Red Snapper (*Lutjanus campechanus*). SEDAR74-AP-02. SEDAR, North Charleston, SC. 10 pp.
- Stunz, G. W., W. F. Patterson III, S. P. Powers, J. H. Cowan, Jr., J. R. Rooker, R. A. Ahrens, K. Boswell, L. Carleton, M. Catalano, J. M. Drymon, J. Hoenig, R. Leaf, V. Lecours, S. Murawski, D. Portnoy, E. Saillant, L. S. Stokes., and R. J. D. Wells. 2021. Estimating the Absolute Abundance of Age-2+ Red Snapper (*Lutjanus campechanus*) in the U.S. Gulf of Mexico. Mississippi-Alabama Sea Grant Consortium, NOAA Sea Grant. 408 pages.
- Taylor IG, KL Doering, KF Johnson, CR Wetzel and IJ Stewart, 2021. Beyond visualizing catch-at-age models: Lessons learned from the r4ss package about software to support stock assessments, *Fisheries Research* 239:105924. <https://doi.org/10.1016/j.fishres.2021.105924>
- Then AY, JM Hoenig, NG Hall, and DA Hewitt. 2015. Evaluating the predictive performance of empirical estimators of natural mortality rate using information on over 200 fish species. *ICES Journal of Marine Science* 72(1):82-92.
- Thorson, J.T., I.J. Stewart and A.E. Punt. 2012. *nwfscAgeingError*: a user interface in R for the Punt et al. (2008) method for calculating ageing error and imprecision. Available from: <http://github.com/nmfscassess/nwfscAgeingError>.
- Thorson JT, KF Johnson, RD Methot and IG Taylor. 2017. Model-based estimates of effective sample size in stock assessment models using the Dirichlet-multinomial distribution. *Fisheries Research* 192: 84–93. [doi:10.1016/j.fishres.2016.06.005](https://doi.org/10.1016/j.fishres.2016.06.005).

## Tables

**Table 1.** Age-specific natural mortality (per year) for Gulf of Mexico Red Snapper used in SEDAR 74.

Age	M	Adj. M
0	0.86	2.00
1	0.64	1.20
2	0.21	0.21
3	0.17	0.17
4	0.15	0.15
5	0.14	0.14
6	0.13	0.13
7	0.12	0.12
8	0.12	0.12
9	0.11	0.11
10	0.11	0.11
11	0.11	0.11
12	0.10	0.10
13	0.10	0.10
14	0.10	0.10
15	0.10	0.10
16	0.10	0.10
17	0.10	0.10
18	0.10	0.10
19	0.10	0.10
20	0.10	0.10



**Table 2.** Maturity parameters for Gulf of Mexico Red Snapper. All parameters were fixed to values provided from the data workshop (base model maturity).

Parameter	East	Central	West
$M_{A50}$	1.95	1.95	2.47
$M \text{ Slope}_{A50}$	-1.57	-1.57	-1.18

**Table 3.** Standardized indices of relative abundance for Eastern Gulf of Mexico Red Snapper used in SEDAR 74.

Year	CPUE Handline	CPUE Combined Video	CPUE Bottom Longline	CPUE Summer Trawl Late	CPUE Fall Trawl Late	CPUE Comm Obs.
1993	0.300					
1994	0.113					
1995	0.251					
1996	0.242					
1997	0.382					
1998	0.264					
1999	1.016					
2000	1.587					
2001	1.102		0.120			
2002	0.952					
2003	1.220		0.426			
2004	2.073		0.687			
2005	1.857		0.525			
2006	2.641		0.257			
2007			1.736			0.397
2008					0.665	0.477
2009			1.161	0.097	0.409	0.822
2010		0.461	1.851	0.034	0.721	0.835
2011		0.605	1.771	1.170		0.851
2012		0.307	0.483	0.556	0.933	0.702

**Table 3 Continued.** Standardized indices of relative abundance for Eastern Gulf of Mexico Red Snapper used in SEDAR 74.

Year	CPUE Handline	CPUE Combined Video	CPUE Bottom Longline	CPUE Summer Trawl Late	CPUE Fall Trawl Late	CPUE Comm Obs.
2013		0.692	2.852	0.174	0.174	0.748
2014		0.389	0.360	0.379	3.262	0.837
2015		1.509		3.356	1.253	0.910
2016		2.036	1.681	2.029	1.602	2.027
2017		1.458	0.646	1.494	0.860	1.493
2018		1.449	0.510	1.179	0.343	1.752
2019		1.094	0.935	0.532	0.777	1.150

**Table 4.** Log scale standard error (SE) associated with each standardized relative abundance index for Eastern Gulf of Mexico Red Snapper.

Year	SE Handline	SE Combined Video	SE Bottom Longline	SE Summer Trawl Late	SE Fall Trawl Late	SE Comm Obs.
1993	0.258					
1994	0.344					
1995	0.234					
1996	0.214					
1997	0.200					
1998	0.240					
1999	0.202					
2000	0.158					
2001	0.189		0.259			
2002	0.185					
2003	0.153		0.201			
2004	0.144		0.170			
2005	0.149		0.259			
2006	0.131		0.258			
2007			0.198			0.218
2008					0.290	0.209
2009			0.150	0.304	0.209	0.213
2010		0.257	0.133	0.379	0.172	0.149
2011		0.181	0.088	0.185		0.110
2012		0.181	0.200	0.164	0.286	0.080

**Table 4 Continued.** Log scale standard error (SE) associated with each standardized relative abundance index for Eastern Gulf of Mexico Red Snapper.

Year	SE Handline	SE Combined Video	SE Bottom Longline	SE Summer Trawl Late	SE Fall Trawl Late	SE Comm Obs.
2013		0.242	0.258	0.304	0.287	0.121
2014		0.179	0.257	0.164	0.140	0.166
2015		0.320		0.129	0.122	0.283
2016		0.126	0.168	0.111	0.171	0.127
2017		0.148	0.199	0.136	0.146	0.411
2018		0.157	0.202	0.128	0.217	0.210
2019		0.208	0.200	0.195	0.160	0.303

**Table 5.** Shrimp Trawl bycatch time series used in SEDAR 74 input as 1000s of fish.

Year	Shrimp Bycatch West	Shrimp Bycatch Central	Shrimp Bycatch East
1950	13889.70	727.27	264.01
1973	14460.00	908.33	308.67
1974	17550.00	516.86	175.64
1975	8357.00	907.58	308.42
1976	30000.00	808.31	274.69
1977	11320.00	1125.52	382.48
1978	6575.00	180.92	61.48
1979	21970.00	812.04	275.95
1980	25550.00	333.40	113.30
1981	53210.00	977.74	332.26
1982	23920.00	1207.62	410.38
1983	17560.00	853.84	290.16
1984	12510.00	611.42	207.78
1985	10440.00	506.10	191.10
1986	5441.00	165.69	51.81
1987	11760.00	233.47	91.53
1988	9602.00	282.27	98.53
1989	10500.00	517.83	137.47
1990	40970.00	1725.73	456.27
1991	40890.00	1402.15	435.85
1992	31660.00	944.17	345.83
1993	34900.00	486.69	264.31
1994	34400.00	702.32	388.68

**Table 5 Continued.** Shrimp Trawl bycatch time series used in SEDAR 74 input as 1000s of fish.

Year	Shrimp Bycatch West	Shrimp Bycatch Central	Shrimp Bycatch East
1995	47470.00	934.17	527.83
1996	36260.00	493.63	567.37
1997	26290.00	1078.91	610.09
1998	56070.00	972.88	645.12
1999	23870.00	1396.53	467.47
2000	11960.00	1657.82	469.18
2001	23970.00	1633.46	682.54
2002	22140.00	1476.17	704.83
2003	30510.00	892.34	380.66
2004	27840.00	1019.89	393.11
2005	12250.00	423.02	202.48
2006	11430.00	1417.67	420.33
2007	6812.00	1055.98	161.02
2008	2710.00	126.64	33.86
2009	3726.00	282.75	68.65
2010	2779.00	119.95	70.25
2011	6389.00	453.82	151.58
2012	8494.00	314.85	71.65
2013	5979.00	394.96	114.04
2014	20170.00	95.09	32.41
2015	17260.00	563.43	162.97
2016	17260.00	583.33	143.07
2017	18230.00	413.95	112.82
2018	18230.00	413.95	112.82
2019	18230.00	413.95	112.82

**Table 6.** Standardized index of relative abundance and corresponding standard errors (SE) for Shrimp Trawl bycatch effort time series used in the assessment.

Year	CPUE Shrimp Effort west	CPUE Shrimp Effort central	CPUE Shrimp Effort east	SE Shrimp Effort west	SE Shrimp Effort central	SE Shrimp Effort east
1950	0.232	0.219	0.198	0.200	0.200	0.200
1951	0.244	0.377	0.341	0.200	0.200	0.200
1952	0.288	0.445	0.404	0.200	0.200	0.200
1953	0.281	0.492	0.446	0.200	0.200	0.200
1954	0.371	0.630	0.572	0.200	0.200	0.200
1955	0.306	0.744	0.675	0.200	0.200	0.200
1956	0.399	0.943	0.855	0.200	0.200	0.200
1957	0.501	1.032	0.936	0.200	0.200	0.200
1958	0.772	1.092	0.990	0.200	0.200	0.200
1959	0.825	1.185	1.075	0.200	0.200	0.200
1960	0.714	1.102	0.999	0.200	0.200	0.200
1961	0.596	0.808	0.733	0.200	0.200	0.200
1962	0.724	1.102	0.999	0.200	0.200	0.200
1963	0.805	1.065	0.965	0.200	0.200	0.200
1964	0.984	1.181	1.071	0.200	0.200	0.200
1965	0.820	1.097	0.994	0.200	0.200	0.200
1966	0.831	1.026	0.930	0.200	0.200	0.200
1967	0.966	1.002	0.908	0.200	0.200	0.200
1968	1.027	1.185	1.074	0.200	0.200	0.200
1969	1.153	1.110	1.007	0.200	0.200	0.200



**Table 6 Continued.** Standardized index of relative abundance and corresponding standard errors (SE) for Shrimp Trawl bycatch effort time series used in the assessment.

Year	CPUE Shrimp Effort west	CPUE Shrimp Effort central	CPUE Shrimp Effort east	SE Shrimp Effort west	SE Shrimp Effort central	SE Shrimp Effort east
1970	0.979	1.071	0.971	0.200	0.200	0.200
1971	1.035	0.998	0.905	0.200	0.200	0.200
1972	1.275	1.038	0.942	0.200	0.200	0.200
1973	1.191	1.158	1.050	0.200	0.200	0.200
1974	1.219	1.072	0.972	0.200	0.200	0.200
1975	1.084	1.100	0.997	0.200	0.200	0.200
1976	1.180	1.017	0.923	0.200	0.200	0.200
1977	1.209	1.184	1.073	0.200	0.200	0.200
1978	1.389	1.158	1.050	0.200	0.200	0.200
1979	1.632	1.294	1.174	0.200	0.200	0.200
1980	1.163	0.732	0.664	0.200	0.200	0.200
1981	1.309	1.123	1.018	0.200	0.200	0.200
1982	1.283	1.345	1.219	0.200	0.200	0.200
1983	1.301	1.501	1.361	0.200	0.200	0.200
1984	1.354	1.767	1.603	0.200	0.200	0.200
1985	1.339	1.588	1.600	0.200	0.200	0.200
1986	1.767	1.557	1.299	0.200	0.200	0.200
1987	1.862	1.691	1.769	0.200	0.200	0.200
1988	1.672	1.701	1.585	0.200	0.200	0.200
1989	1.693	1.636	1.159	0.200	0.200	0.200

**Table 6 Continued.** Standardized index of relative abundance and corresponding standard errors (SE) for Shrimp Trawl bycatch effort time series used in the assessment.

Year	CPUE Shrimp Effort west	CPUE Shrimp Effort central	CPUE Shrimp Effort east	SE Shrimp Effort west	SE Shrimp Effort central	SE Shrimp Effort east
1990	1.729	1.577	1.113	0.200	0.200	0.200
1991	1.776	1.215	1.008	0.200	0.200	0.200
1992	1.885	1.275	1.247	0.200	0.200	0.200
1993	1.675	1.097	1.590	0.200	0.200	0.200
1994	1.732	1.130	1.669	0.200	0.200	0.200
1995	1.327	1.271	1.917	0.200	0.200	0.200
1996	1.363	0.892	2.735	0.200	0.200	0.200
1997	1.604	1.315	1.985	0.200	0.200	0.200
1998	1.499	1.301	2.301	0.200	0.200	0.200
1999	1.503	1.383	1.235	0.200	0.200	0.200
2000	1.501	1.205	0.910	0.200	0.200	0.200
2001	1.593	1.196	1.334	0.200	0.200	0.200
2002	1.685	1.429	1.820	0.200	0.200	0.200
2003	1.447	1.125	1.280	0.200	0.200	0.200
2004	1.215	0.991	1.020	0.200	0.200	0.200
2005	0.851	0.645	0.824	0.200	0.200	0.200
2006	0.826	0.562	0.445	0.200	0.200	0.200
2007	0.718	0.667	0.272	0.200	0.200	0.200
2008	0.586	0.602	0.430	0.200	0.200	0.200
2009	0.724	0.778	0.504	0.200	0.200	0.200

**Table 6 Continued.** Standardized index of relative abundance and corresponding standard errors (SE) for Shrimp Trawl bycatch effort time series used in the assessment.

Year	CPUE Shrimp Effort west	CPUE Shrimp Effort central	CPUE Shrimp Effort east	SE Shrimp Effort west	SE Shrimp Effort central	SE Shrimp Effort east
2010	0.609	0.449	0.701	0.200	0.200	0.200
2011	0.687	0.591	0.527	0.200	0.200	0.200
2012	0.685	0.537	0.326	0.200	0.200	0.200
2013	0.609	0.538	0.415	0.200	0.200	0.200
2014	0.693	0.294	0.267	0.200	0.200	0.200
2015	0.669	0.432	0.333	0.200	0.200	0.200
2016	0.739	0.573	0.375	0.200	0.200	0.200
2017	0.682	0.424	0.631	0.200	0.200	0.200
2018	0.674	0.444	0.709	0.200	0.200	0.200
2019	0.569	0.496	0.571	0.200	0.200	0.200

**Table 7.** Standardized indices of relative abundance for Central Gulf of Mexico Red Snapper used in SEDAR 74.

Year	CPUE Combined Video	CPUE Bottom Longline	CPUE Larval Survey	CPUE Summer Trawl Late	CPUE Fall Trawl Late
1991			0.120		
1992					
1993	0.100				
1994	0.088		0.031		
1995	0.050		0.060		
1996	0.140				
1997	0.265		0.088		
1998					
1999			0.369		
2000			0.804		
2001		0.171	0.153		
2002	0.624	0.117			
2003		0.269	0.397		
2004	1.216	0.114	0.159		
2005	0.998	0.093			
2006	0.986	0.165	0.608		
2007	1.601		0.891		
2008	1.420		0.091		0.604
2009	1.864	0.369	0.506	0.447	2.281
2010	1.688	1.264	2.725	1.014	0.693

**Table 7 Continued.** Standardized indices of relative abundance for Central Gulf of Mexico Red Snapper used in SEDAR 74.

Year	CPUE Combined Video	CPUE Bottom Longline	CPUE Larval Survey	CPUE Summer Trawl Late	CPUE Fall Trawl Late
2011	1.633	1.691	0.906	0.568	0.570
2012	0.875	1.158	0.788	1.077	1.368
2013	1.069	0.553	0.855	1.372	0.701
2014	0.977	2.080	1.484	0.684	0.978
2015	0.805	2.389	0.469	0.653	1.292
2016	1.406	2.560	1.032	0.952	0.985
2017	1.543	0.886	4.255	1.672	0.563
2018	1.111	1.200	1.805	1.144	1.271
2019	1.542	1.922	4.405	1.416	0.695

**Table 8.** Standardized indices of relative abundance for Western Gulf of Mexico Red Snapper used in SEDAR 74.

Year	CPUE SEAMAP Video	CPUE Bottom Longline	CPUE Larval Survey	CPUE Summer Trawl Late	CPUE Summer Trawl Early	CPUE Fall Trawl Late	CPUE Fall Trawl Early
1984					0.747		
1985					1.110		
1986			0.282		0.294		
1987			0.439		0.710		
1988					0.347		0.428
1989			0.549		0.256		0.857
1990			0.445		2.262		0.909
1991			0.215		1.021		1.027
1992			0.254		0.644		0.316
1993	0.137		0.269		0.704		0.574
1994	0.345		0.197		1.345		1.625
1995	0.306		0.759		1.176		1.747
1996	0.702		0.534		1.309		0.870
1997	1.550		0.892		0.994		1.290
1998					0.886		0.595
1999			0.380		0.759		1.374
2000			1.219		1.391		0.907
2001		0.323	0.847		0.787		0.681
2002	1.082	0.247	0.644		1.094		0.650
2003		0.289	1.207		0.614		1.152

**Table 8 Continued.** Standardized indices of relative abundance for Western Gulf of Mexico Red Snapper used in SEDAR 74.

Year	CPUE SEAMAP Video	CPUE Bottom Longline	CPUE Larval Survey	CPUE Summer Trawl Late	CPUE Summer Trawl Early	CPUE Fall Trawl Late	CPUE Fall Trawl Early
2004	0.948	0.345	0.685		1.331		1.798
2005	0.961				1.502		1.272
2006	0.380	0.276	1.194		1.419		1.084
2007	1.020	0.299	1.047		1.166		0.845
2008	0.723				1.134	0.445	
2009	1.077	0.514	1.276	0.366		1.472	
2010	2.245	0.252	0.521	0.870		0.693	
2011	1.739	0.705	2.104	1.210		0.816	
2012	1.874	1.240	1.980	0.835		1.575	
2013	2.625	1.143	1.054	1.308		0.664	
2014	3.487	0.864	1.550	0.793		0.900	
2015	2.137	2.125		1.086		1.649	
2016	2.640	1.761	3.178	0.894		1.106	
2017	3.036	2.698	0.839	0.854		0.765	
2018	6.044	1.561	1.593	1.639		1.077	
2019	3.342	2.357	2.848	1.145		0.837	

**Table 9.** Log scale standard error (SE) associated with each standardized relative abundance index for Central Gulf of Mexico Red Snapper.

Year	SE Combined Video	SE Bottom Longline	SE Larval Survey	SE Summer Trawl Late	SE Fall Trawl Late
1991			0.294		
1992					
1993	0.433				
1994	0.518		0.296		
1995	0.722		0.296		
1996	0.347				
1997	0.267		0.295		
1998					
1999			0.200		
2000			0.178		
2001		0.242	0.198		
2002	0.208	0.243			
2003		0.208	0.177		
2004	0.164	0.304	0.296		
2005	0.140	0.304			
2006	0.147	0.305	0.199		
2007	0.154		0.146		
2008	0.122		0.294		0.223
2009	0.114	0.209	0.199	0.175	0.126
2010	0.099	0.151	0.123	0.204	0.186



**Table 9 Continued.** Log scale standard error (SE) associated with each standardized relative abundance index for Central Gulf of Mexico Red Snapper.

Year	SE Combined Video	SE Bottom Longline	SE Larval Survey	SE Summer Trawl Late	SE Fall Trawl Late
2011	0.085	0.092	0.200	0.240	0.227
2012	0.106	0.207	0.157	0.201	0.192
2013	0.127	0.211	0.157	0.224	0.220
2014	0.148	0.140	0.159	0.203	0.195
2015	0.113	0.127	0.295	0.223	0.183
2016	0.080	0.138	0.132	0.193	0.269
2017	0.090	0.169	0.089	0.146	0.184
2018	0.129	0.168	0.125	0.201	0.181
2019	0.086	0.182	0.096	0.190	0.215

**Table 10.** Log scale standard error (SE) associated with each standardized relative abundance index for Western Gulf of Mexico Red Snapper.

Year	SE SEAMAP Video	SE Bottom Longline	SE Larval Survey	SE Summer Trawl Late	SE Summer Trawl Early	SE Fall Trawl Late	SE Fall Trawl Early
1984					0.272		
1985					0.292		
1986			0.300		0.406		
1987			0.300		0.211		
1988					0.236		0.234
1989			0.295		0.289		0.220
1990			0.247		0.154		0.194
1991			0.335		0.181		0.184
1992			0.234		0.190		0.235
1993	0.156		0.234		0.186		0.220
1994	0.183		0.300		0.172		0.190
1995	0.215		0.170		0.164		0.173
1996	0.198		0.206		0.164		0.201
1997	0.208		0.163		0.166		0.196
1998					0.184		0.225
1999			0.218		0.185		0.182
2000			0.160		0.148		0.185
2001		0.194	0.232		0.251		0.211
2002	0.218	0.168	0.177		0.164		0.209
2003		0.212	0.152		0.202		0.189

**Table 10 Continued.** Log scale standard error (SE) associated with each standardized relative abundance index for Western Gulf of Mexico Red Snapper.

Year	SE SEAMAP Video	SE Bottom Longline	SE Larval Survey	SE Summer Trawl Late	SE Summer Trawl Early	SE Fall Trawl Late	SE Fall Trawl Early
2004	0.167	0.212	0.179		0.156		0.171
2005	0.204				0.160		0.161
2006	0.215	0.259	0.178		0.142		0.193
2007	0.173	0.258	0.151		0.175		0.225
2008	0.192				0.149	0.155	
2009	0.235	0.195	0.147	0.201		0.142	
2010	0.198	0.334	0.218	0.196		0.200	
2011	0.241	0.144	0.169	0.194		0.188	
2012	0.198	0.206	0.147	0.186		0.188	
2013	0.207	0.188	0.151	0.218		0.276	
2014	0.174	0.227	0.162	0.212		0.195	
2015	0.200	0.173		0.197		0.180	
2016	0.228	0.166	0.136	0.198		0.232	
2017	0.207	0.124	0.177	0.211		0.225	
2018	0.200	0.169	0.141	0.183		0.193	
2019	0.183	0.169	0.122	0.204		0.226	

**Table 11.** Derived base Red Snapper Count numbers and weighted Coefficients of Variation (CV) by Stock ID area.

Area	Count	Weighted CV
West	30,823,985	27.30
East	24,706,670	21.80
Central	30,806,497	22.00

**Table 12.** Growth parameters for Gulf of Mexico Red Snapper. All parameters were fixed at values provided as a result of the Data Workshop (see Data Workshop report, SEDAR 2022).

Parameter	East	Central	West
$A_{\min}$	0.25	0.25	0.25
$L_{A\min}$	15.94	17.11	15.94
$L_{A\max}$	85.99	85.43	81.88
$K$ (year <sup>-1</sup> )	0.17	0.15	0.14

**Table 13.** List of relevant Stock Synthesis recruitment related parameters for Gulf of Mexico Red Snapper. The list includes predicted parameter values, lower and upper bounds of the parameters, associated standard errors and coefficients of variation, prior type and densities (value, SE) if applicable, and phases. Parameters designated as 'F' (Fixed) were held at their initial values and have no associated range or SE.

Label	Value	Range	SE	CV	Prior	Phase
SR_LN(R0)	11.35	(10,15)	0.042	0.004	Sym_Beta(0.5)	1
SR_BH_steep	0.99					F
SR_sigmaR	0.6					F
SR_regime	0.00e+00					F
SR_autocorr	0.00e+00					F
RecrDist_GP_1_area_1	-2.48	(-6,4)	0.063	-	Normal(-2.085,0.5)	2
RecrDist_GP_2_area_2	-1.19	(-6,4)	0.07	-	Normal(-0.62,0.5)	2
RecrDist_GP_3_area_3	0.00e+00					F
RecrDist_GP_1_area_1_dev_se	0.5					F
RecrDist_GP_2_area_2_dev_se	0.5					F

**Table 14.** Time varying maturity parameters used for blocking for Gulf of Mexico Red Snapper (sensitivity run).

Year	Parameter	East	Central	West
1970	$M_{A50}$	1.49	1.49	1.71
	M Slope $_{A50}$	-2.39	-2.39	-1.99
1991	$M_{A50}$	1.39	1.39	1.51
	M Slope $_{A50}$	-3.61	-3.61	-3.21
2009	$M_{A50}$	1.49	1.49	1.71
	M Slope $_{A50}$	-2.39	-2.39	-1.99

**Table 15.** Estimates of annual exploitation rate (total biomass killed age 2+ / total biomass age 2+) combined across all fleets for Gulf of Mexico Red Snapper, which was used as the proxy for annual fishing mortality rate.

Year	S74
1950	0.043
1951	0.046
1952	0.050
1953	0.048
1954	0.053
1955	0.052
1956	0.063
1957	0.071
1958	0.100
1959	0.106
1960	0.110
1961	0.111
1962	0.125
1963	0.133
1964	0.150
1965	0.147
1966	0.147
1967	0.168
1968	0.182
1969	0.190
1970	0.190
1971	0.214
1972	0.247
1973	0.269
1974	0.307



**Table 15 Continued.** Estimates of annual exploitation rate (total biomass killed age 2+ / total biomass age 2+) combined across all fleets for Gulf of Mexico Red Snapper, which was used as the proxy for annual fishing mortality rate.

Year	S74
1975	0.323
1976	0.350
1977	0.353
1978	0.378
1979	0.408
1980	0.375
1981	0.496
1982	0.400
1983	0.727
1984	0.470
1985	0.472
1986	0.504
1987	0.439
1988	0.496
1989	0.455
1990	0.315
1991	0.333
1992	0.360
1993	0.448
1994	0.406
1995	0.327
1996	0.363
1997	0.434
1998	0.398
1999	0.430

**Table 15 Continued.** Estimates of annual exploitation rate (total biomass killed age 2+ / total biomass age 2+) combined across all fleets for Gulf of Mexico Red Snapper, which was used as the proxy for annual fishing mortality rate.

Year	S74
2000	0.401
2001	0.402
2002	0.492
2003	0.463
2004	0.503
2005	0.429
2006	0.351
2007	0.274
2008	0.163
2009	0.171
2010	0.164
2011	0.196
2012	0.162
2013	0.186
2014	0.140
2015	0.156
2016	0.152
2017	0.189
2018	0.145
2019	0.183

**Table 16.** Estimates of annual exploitation rate (total biomass killed age 2+ / total biomass age 2+) by commercial fleets for Western Gulf of Mexico Red Snapper.

Year	Charter Closed Season Discards	Charter	Headboat	Private Closed Season Discards	Private
1950	0	0.007	0.004	0	0.002
1951	0	0.007	0.004	0	0.002
1952	0	0.007	0.005	0	0.002
1953	0	0.007	0.005	0	0.002
1954	0	0.007	0.005	0	0.002
1955	0	0.007	0.005	0	0.002
1956	0	0.008	0.005	0	0.003
1957	0	0.009	0.006	0	0.003
1958	0	0.011	0.007	0	0.004
1959	0	0.012	0.008	0	0.004
1960	0	0.014	0.009	0	0.005
1961	0	0.015	0.009	0	0.005
1962	0	0.016	0.010	0	0.005
1963	0	0.017	0.011	0	0.006
1964	0	0.018	0.011	0	0.006
1965	0	0.012	0.009	0	0.018
1966	0	0.013	0.009	0	0.019
1967	0	0.014	0.010	0	0.020
1968	0	0.015	0.011	0	0.022
1969	0	0.016	0.012	0	0.024
1970	0	0.018	0.013	0	0.026
1971	0	0.021	0.015	0	0.030
1972	0	0.024	0.017	0	0.035
1973	0	0.028	0.020	0	0.041
1974	0	0.033	0.023	0	0.047

**Table 16 Continued.** Estimates of annual exploitation rate (total biomass killed age 2+ / total biomass age 2+) by recreational fleets for Western Gulf of Mexico Red Snapper.

Year	Charter Closed Season Discards	Charter	Headboat	Private Closed Season Discards	Private
1975	0	0.014	0.016	0.000	0.091
1976	0	0.015	0.017	0.000	0.097
1977	0	0.016	0.018	0.000	0.103
1978	0	0.017	0.019	0.000	0.112
1979	0	0.020	0.022	0.000	0.128
1980	0	0.023	0.026	0.000	0.148
1981	0	0.018	0.021	0.000	0.222
1982	0	0.025	0.024	0.000	0.119
1983	0	0.036	0.020	0.000	0.251
1984	0	0.032	0.032	0.000	0.079
1985	0	0.056	0.036	0.000	0.149
1986	0	0.012	0.029	0.000	0.197
1987	0	0.009	0.033	0.000	0.067
1988	0	0.002	0.047	0.000	0.126
1989	0	0.011	0.048	0.000	0.093
1990	0	0.007	0.038	0.000	0.081
1991	0	0.019	0.028	0.000	0.067
1992	0	0.017	0.037	0.000	0.070
1993	0	0.012	0.038	0.000	0.102
1994	0	0.010	0.048	0.000	0.122
1995	0	0.012	0.047	0.000	0.138
1996	0	0.010	0.034	0.000	0.092
1997	0	0.010	0.030	0.000	0.102
1998	0	0.012	0.030	0.001	0.113
1999	0	0.004	0.011	0.005	0.119

**Table 16 Continued.** Estimates of annual exploitation rate (total biomass killed age 2+ / total biomass age 2+) by recreational fleets for Western Gulf of Mexico Red Snapper.

Year	Charter Closed Season Discards	Charter	Headboat	Private Closed Season Discards	Private
2000	0.000	0.002	0.012	0.003	0.098
2001	0.000	0.003	0.016	0.002	0.069
2002	0.000	0.008	0.020	0.003	0.069
2003	0.000	0.010	0.016	0.009	0.075
2004	0.000	0.020	0.020	0.012	0.075
2005	0.001	0.017	0.018	0.009	0.116
2006	0.000	0.018	0.017	0.008	0.134
2007	0.000	0.021	0.021	0.005	0.092
2008	0.001	0.009	0.010	0.017	0.059
2009	0.001	0.005	0.009	0.008	0.049
2010	0.000	0.007	0.006	0.009	0.028
2011	0.000	0.002	0.005	0.012	0.035
2012	0.000	0.003	0.005	0.005	0.034
2013	0.000	0.004	0.003	0.005	0.051
2014	0.000	0.001	0.003	0.001	0.043
2015	0.000	0.003	0.004	0.001	0.046
2016	0.000	0.002	0.004	0.000	0.021
2017	0.000	0.002	0.004	0.000	0.032
2018	0.000	0.001	0.003	0.000	0.034
2019	0.000	0.004	0.004	0.000	0.056

**Table 17.** Estimates of annual exploitation rate (total biomass killed age 2+ / total biomass age 2+) by commercial fleets for Central Gulf of Mexico Red Snapper.

Year	Charter Closed Season Discards	Charter	Headboat	Private Closed Season Discards	Private
1950	0	0.020	0.010	0	0.007
1951	0	0.020	0.010	0	0.007
1952	0	0.020	0.010	0	0.007
1953	0	0.020	0.010	0	0.007
1954	0	0.020	0.010	0	0.007
1955	0	0.020	0.010	0	0.007
1956	0	0.022	0.011	0	0.008
1957	0	0.025	0.012	0	0.008
1958	0	0.027	0.013	0	0.009
1959	0	0.030	0.015	0	0.010
1960	0	0.034	0.016	0	0.011
1961	0	0.036	0.017	0	0.012
1962	0	0.038	0.019	0	0.012
1963	0	0.041	0.020	0	0.013
1964	0	0.044	0.021	0	0.014
1965	0	0.038	0.019	0	0.023
1966	0	0.040	0.020	0	0.024
1967	0	0.043	0.021	0	0.025
1968	0	0.045	0.022	0	0.026
1969	0	0.048	0.023	0	0.028
1970	0	0.050	0.024	0	0.029
1971	0	0.056	0.027	0	0.032
1972	0	0.063	0.030	0	0.036
1973	0	0.071	0.034	0	0.040
1974	0	0.082	0.038	0	0.045

**Table 17 Continued.** Estimates of annual exploitation rate (total biomass killed age 2+ / total biomass age 2+) by commercial fleets for Central Gulf of Mexico Red Snapper.

Year	Charter Closed Season Discards	Charter	Headboat	Private Closed Season Discards	Private
1975	0.000	0.072	0.035	0.000	0.068
1976	0.000	0.084	0.041	0.000	0.083
1977	0.000	0.096	0.046	0.000	0.090
1978	0.000	0.105	0.049	0.000	0.093
1979	0.000	0.105	0.048	0.000	0.086
1980	0.000	0.099	0.045	0.000	0.080
1981	0.000	0.016	0.008	0.000	0.257
1982	0.000	0.123	0.059	0.000	0.034
1983	0.000	0.249	0.118	0.000	0.105
1984	0.000	0.086	0.042	0.000	0.058
1985	0.000	0.092	0.045	0.000	0.108
1986	0.000	0.209	0.005	0.000	0.058
1987	0.000	0.250	0.004	0.000	0.160
1988	0.000	0.230	0.006	0.000	0.089
1989	0.000	0.137	0.005	0.000	0.215
1990	0.000	0.109	0.009	0.000	0.310
1991	0.000	0.116	0.007	0.000	0.430
1992	0.000	0.187	0.012	0.000	0.369
1993	0.000	0.344	0.011	0.000	0.476
1994	0.000	0.237	0.014	0.000	0.396
1995	0.000	0.307	0.017	0.000	0.210
1996	0.000	0.347	0.016	0.000	0.331
1997	0.001	0.414	0.025	0.018	0.442
1998	0.005	0.389	0.018	0.015	0.185
1999	0.007	0.259	0.013	0.019	0.382

**Table 17 Continued.** Estimates of annual exploitation rate (total biomass killed age 2+ / total biomass age 2+) by commercial fleets for Central Gulf of Mexico Red Snapper.

Year	Charter Closed Season Discards	Charter	Headboat	Private Closed Season Discards	Private
2000	0.007	0.192	0.018	0.067	0.316
2001	0.005	0.197	0.014	0.119	0.306
2002	0.004	0.205	0.014	0.126	0.498
2003	0.004	0.233	0.016	0.090	0.430
2004	0.004	0.246	0.014	0.051	0.595
2005	0.004	0.205	0.013	0.085	0.454
2006	0.007	0.206	0.015	0.049	0.359
2007	0.003	0.124	0.005	0.041	0.477
2008	0.007	0.039	0.009	0.096	0.144
2009	0.005	0.039	0.009	0.055	0.194
2010	0.003	0.012	0.004	0.091	0.181
2011	0.005	0.023	0.008	0.084	0.206
2012	0.004	0.018	0.007	0.099	0.162
2013	0.008	0.023	0.006	0.079	0.239
2014	0.007	0.004	0.006	0.089	0.102
2015	0.004	0.018	0.006	0.050	0.135
2016	0.006	0.028	0.005	0.071	0.151
2017	0.006	0.035	0.006	0.103	0.279
2018	0.005	0.023	0.006	0.073	0.135
2019	0.005	0.028	0.004	0.093	0.182



**Table 18.** Estimates of annual exploitation rate (total biomass killed age 2+ / total biomass age 2+) by commercial fleets for Eastern Gulf of Mexico Red Snapper.

Year	Charter Closed Season Discards	Charter	Headboat	Private Closed Season Discards	Private
1950	0	0.019	0.000	0	0.005
1951	0	0.019	0.000	0	0.005
1952	0	0.019	0.000	0	0.005
1953	0	0.020	0.000	0	0.005
1954	0	0.020	0.000	0	0.005
1955	0	0.020	0.001	0	0.005
1956	0	0.022	0.001	0	0.006
1957	0	0.025	0.001	0	0.007
1958	0	0.028	0.001	0	0.008
1959	0	0.032	0.001	0	0.009
1960	0	0.035	0.002	0	0.009
1961	0	0.038	0.002	0	0.010
1962	0	0.041	0.002	0	0.011
1963	0	0.044	0.002	0	0.011
1964	0	0.048	0.002	0	0.012
1965	0	0.031	0.002	0	0.027
1966	0	0.033	0.002	0	0.029
1967	0	0.036	0.003	0	0.031
1968	0	0.038	0.003	0	0.032
1969	0	0.040	0.003	0	0.034
1970	0	0.042	0.003	0	0.035
1971	0	0.047	0.003	0	0.039
1972	0	0.052	0.004	0	0.043
1973	0	0.057	0.004	0	0.047
1974	0	0.062	0.004	0	0.050

**Table 18 Continued.** Estimates of annual exploitation rate (total biomass killed age 2+ / total biomass age 2+) by commercial fleets for Eastern Gulf of Mexico Red Snapper.

Year	Charter Closed Season Discards	Charter	Headboat	Private Closed Season Discards	Private
1975	0.000	0.018	0.005	0.000	0.089
1976	0.000	0.017	0.005	0.000	0.074
1977	0.000	0.019	0.005	0.000	0.089
1978	0.000	0.020	0.006	0.000	0.100
1979	0.000	0.021	0.006	0.000	0.102
1980	0.000	0.020	0.006	0.000	0.089
1981	0.000	0.015	0.007	0.000	0.190
1982	0.000	0.004	0.002	0.000	0.006
1983	0.000	0.035	0.018	0.000	0.372
1984	0.000	0.061	0.032	0.000	0.027
1985	0.000	0.025	0.013	0.000	0.181
1986	0.000	0.228	0.004	0.000	0.281
1987	0.000	0.018	0.002	0.000	0.225
1988	0.000	0.036	0.004	0.000	0.150
1989	0.000	0.065	0.002	0.000	0.353
1990	0.000	0.000	0.001	0.000	0.436
1991	0.000	0.002	0.004	0.000	0.356
1992	0.000	0.065	0.001	0.000	0.095
1993	0.000	0.000	0.009	0.000	0.000
1994	0.000	0.001	0.003	0.000	0.000
1995	0.000	0.000	0.001	0.000	0.065
1996	0.000	0.005	0.001	0.000	0.600
1997	0.001	0.027	0.000	0.000	0.000
1998	0.000	0.155	0.001	0.067	0.000
1999	0.000	0.012	0.017	0.032	0.131

**Table 18 Continued.** Estimates of annual exploitation rate (total biomass killed age 2+ / total biomass age 2+) by commercial fleets for Eastern Gulf of Mexico Red Snapper.

Year	Charter Closed Season Discards	Charter	Headboat	Private Closed Season Discards	Private
2000	0.000	0.005	0.005	0.002	0.035
2001	0.004	0.006	0.004	0.000	0.000
2002	0.000	0.003	0.001	0.000	0.042
2003	0.002	0.006	0.001	0.002	0.011
2004	0.001	0.001	0.003	0.035	0.028
2005	0.001	0.006	0.009	0.015	0.314
2006	0.006	0.127	0.002	0.008	0.054
2007	0.001	0.001	0.001	0.000	0.112
2008	0.005	0.006	0.002	0.011	0.009
2009	0.003	0.009	0.004	0.014	0.027
2010	0.001	0.003	0.002	0.027	0.005
2011	0.000	0.000	0.003	0.485	0.018
2012	0.000	0.002	0.004	0.004	0.025
2013	0.002	0.013	0.004	0.002	0.006
2014	0.003	0.003	0.003	0.012	0.008
2015	0.003	0.013	0.005	0.004	0.003
2016	0.008	0.007	0.003	0.106	0.028
2017	0.021	0.013	0.005	0.026	0.052
2018	0.005	0.013	0.005	0.071	0.064
2019	0.002	0.010	0.005	0.048	0.064

**Table 19.** Estimates of annual exploitation rate (total biomass killed age 2+ / total biomass age 2+) by recreational fleets for Western Gulf of Mexico Red Snapper.

Year	Charter Closed Season Discards	Charter	Headboat	Private Closed Season Discards	Private
1950	0	0.007	0.004	0	0.002
1951	0	0.007	0.004	0	0.002
1952	0	0.007	0.005	0	0.002
1953	0	0.007	0.005	0	0.002
1954	0	0.007	0.005	0	0.002
1955	0	0.007	0.005	0	0.002
1956	0	0.008	0.005	0	0.003
1957	0	0.009	0.006	0	0.003
1958	0	0.011	0.007	0	0.004
1959	0	0.012	0.008	0	0.004
1960	0	0.014	0.009	0	0.005
1961	0	0.015	0.009	0	0.005
1962	0	0.016	0.010	0	0.005
1963	0	0.017	0.011	0	0.006
1964	0	0.018	0.011	0	0.006
1965	0	0.012	0.009	0	0.018
1966	0	0.013	0.009	0	0.019
1967	0	0.014	0.010	0	0.020
1968	0	0.015	0.011	0	0.022
1969	0	0.016	0.012	0	0.024
1970	0	0.018	0.013	0	0.026
1971	0	0.021	0.015	0	0.030
1972	0	0.024	0.017	0	0.035
1973	0	0.028	0.020	0	0.041
1974	0	0.033	0.023	0	0.047

**Table 19 Continued.** Estimates of annual exploitation rate (total biomass killed age 2+ / total biomass age 2+) by recreational fleets for Western Gulf of Mexico Red Snapper.

Year	Charter Closed Season Discards	Charter	Headboat	Private Closed Season Discards	Private
1975	0	0.014	0.016	0.000	0.091
1976	0	0.015	0.017	0.000	0.097
1977	0	0.016	0.018	0.000	0.103
1978	0	0.017	0.019	0.000	0.112
1979	0	0.020	0.022	0.000	0.128
1980	0	0.023	0.026	0.000	0.148
1981	0	0.018	0.021	0.000	0.222
1982	0	0.025	0.024	0.000	0.119
1983	0	0.036	0.020	0.000	0.251
1984	0	0.032	0.032	0.000	0.079
1985	0	0.056	0.036	0.000	0.149
1986	0	0.012	0.029	0.000	0.197
1987	0	0.009	0.033	0.000	0.067
1988	0	0.002	0.047	0.000	0.126
1989	0	0.011	0.048	0.000	0.093
1990	0	0.007	0.038	0.000	0.081
1991	0	0.019	0.028	0.000	0.067
1992	0	0.017	0.037	0.000	0.070
1993	0	0.012	0.038	0.000	0.102
1994	0	0.010	0.048	0.000	0.122
1995	0	0.012	0.047	0.000	0.138
1996	0	0.010	0.034	0.000	0.092
1997	0	0.010	0.030	0.000	0.102
1998	0	0.012	0.030	0.001	0.113
1999	0	0.004	0.011	0.005	0.119

**Table 19 Continued.** Estimates of annual exploitation rate (total biomass killed age 2+ / total biomass age 2+) by recreational fleets for Western Gulf of Mexico Red Snapper.

Year	Charter Closed Season Discards	Charter	Headboat	Private Closed Season Discards	Private
2000	0.000	0.002	0.012	0.003	0.098
2001	0.000	0.003	0.016	0.002	0.069
2002	0.000	0.008	0.020	0.003	0.069
2003	0.000	0.010	0.016	0.009	0.075
2004	0.000	0.020	0.020	0.012	0.075
2005	0.001	0.017	0.018	0.009	0.116
2006	0.000	0.018	0.017	0.008	0.134
2007	0.000	0.021	0.021	0.005	0.092
2008	0.001	0.009	0.010	0.017	0.059
2009	0.001	0.005	0.009	0.008	0.049
2010	0.000	0.007	0.006	0.009	0.028
2011	0.000	0.002	0.005	0.012	0.035
2012	0.000	0.003	0.005	0.005	0.034
2013	0.000	0.004	0.003	0.005	0.051
2014	0.000	0.001	0.003	0.001	0.043
2015	0.000	0.003	0.004	0.001	0.046
2016	0.000	0.002	0.004	0.000	0.021
2017	0.000	0.002	0.004	0.000	0.032
2018	0.000	0.001	0.003	0.000	0.034
2019	0.000	0.004	0.004	0.000	0.056

**Table 20.** Estimates of annual exploitation rate (total biomass killed age 2+ / total biomass age 2+) by recreational fleets for Central Gulf of Mexico Red Snapper.

Year	Charter Closed Season Discards	Charter	Headboat	Private Closed Season Discards	Private
1950	0	0.020	0.010	0	0.007
1951	0	0.020	0.010	0	0.007
1952	0	0.020	0.010	0	0.007
1953	0	0.020	0.010	0	0.007
1954	0	0.020	0.010	0	0.007
1955	0	0.020	0.010	0	0.007
1956	0	0.022	0.011	0	0.008
1957	0	0.025	0.012	0	0.008
1958	0	0.027	0.013	0	0.009
1959	0	0.030	0.015	0	0.010
1960	0	0.034	0.016	0	0.011
1961	0	0.036	0.017	0	0.012
1962	0	0.038	0.019	0	0.012
1963	0	0.041	0.020	0	0.013
1964	0	0.044	0.021	0	0.014
1965	0	0.038	0.019	0	0.023
1966	0	0.040	0.020	0	0.024
1967	0	0.043	0.021	0	0.025
1968	0	0.045	0.022	0	0.026
1969	0	0.048	0.023	0	0.028
1970	0	0.050	0.024	0	0.029
1971	0	0.056	0.027	0	0.032
1972	0	0.063	0.030	0	0.036
1973	0	0.071	0.034	0	0.040
1974	0	0.082	0.038	0	0.045

**Table 20 Continued.** Estimates of annual exploitation rate (total biomass killed age 2+ / total biomass age 2+) by recreational fleets for Central Gulf of Mexico Red Snapper.

Year	Charter Closed Season Discards	Charter	Headboat	Private Closed Season Discards	Private
1975	0.000	0.072	0.035	0.000	0.068
1976	0.000	0.084	0.041	0.000	0.083
1977	0.000	0.096	0.046	0.000	0.090
1978	0.000	0.105	0.049	0.000	0.093
1979	0.000	0.105	0.048	0.000	0.086
1980	0.000	0.099	0.045	0.000	0.080
1981	0.000	0.016	0.008	0.000	0.257
1982	0.000	0.123	0.059	0.000	0.034
1983	0.000	0.249	0.118	0.000	0.105
1984	0.000	0.086	0.042	0.000	0.058
1985	0.000	0.092	0.045	0.000	0.108
1986	0.000	0.209	0.005	0.000	0.058
1987	0.000	0.250	0.004	0.000	0.160
1988	0.000	0.230	0.006	0.000	0.089
1989	0.000	0.137	0.005	0.000	0.215
1990	0.000	0.109	0.009	0.000	0.310
1991	0.000	0.116	0.007	0.000	0.430
1992	0.000	0.187	0.012	0.000	0.369
1993	0.000	0.344	0.011	0.000	0.476
1994	0.000	0.237	0.014	0.000	0.396
1995	0.000	0.307	0.017	0.000	0.210
1996	0.000	0.347	0.016	0.000	0.331
1997	0.001	0.414	0.025	0.018	0.442
1998	0.005	0.389	0.018	0.015	0.185
1999	0.007	0.259	0.013	0.019	0.382



**Table 20 Continued.** Estimates of annual exploitation rate (total biomass killed age 2+ / total biomass age 2+) by recreational fleets for Central Gulf of Mexico Red Snapper.

Year	Charter Closed Season Discards	Charter	Headboat	Private Closed Season Discards	Private
2000	0.007	0.192	0.018	0.067	0.316
2001	0.005	0.197	0.014	0.119	0.306
2002	0.004	0.205	0.014	0.126	0.498
2003	0.004	0.233	0.016	0.090	0.430
2004	0.004	0.246	0.014	0.051	0.595
2005	0.004	0.205	0.013	0.085	0.454
2006	0.007	0.206	0.015	0.049	0.359
2007	0.003	0.124	0.005	0.041	0.477
2008	0.007	0.039	0.009	0.096	0.144
2009	0.005	0.039	0.009	0.055	0.194
2010	0.003	0.012	0.004	0.091	0.181
2011	0.005	0.023	0.008	0.084	0.206
2012	0.004	0.018	0.007	0.099	0.162
2013	0.008	0.023	0.006	0.079	0.239
2014	0.007	0.004	0.006	0.089	0.102
2015	0.004	0.018	0.006	0.050	0.135
2016	0.006	0.028	0.005	0.071	0.151
2017	0.006	0.035	0.006	0.103	0.279
2018	0.005	0.023	0.006	0.073	0.135
2019	0.005	0.028	0.004	0.093	0.182

**Table 21.** Estimates of annual exploitation rate (total biomass killed age 2+ / total biomass age 2+) by recreational fleets for Eastern Gulf of Mexico Red Snapper.

Year	Charter Closed Season Discards	Charter	Headboat	Private Closed Season Discards	Private
1950	0	0.019	0.000	0	0.005
1951	0	0.019	0.000	0	0.005
1952	0	0.019	0.000	0	0.005
1953	0	0.020	0.000	0	0.005
1954	0	0.020	0.000	0	0.005
1955	0	0.020	0.001	0	0.005
1956	0	0.022	0.001	0	0.006
1957	0	0.025	0.001	0	0.007
1958	0	0.028	0.001	0	0.008
1959	0	0.032	0.001	0	0.009
1960	0	0.035	0.002	0	0.009
1961	0	0.038	0.002	0	0.010
1962	0	0.041	0.002	0	0.011
1963	0	0.044	0.002	0	0.011
1964	0	0.048	0.002	0	0.012
1965	0	0.031	0.002	0	0.027
1966	0	0.033	0.002	0	0.029
1967	0	0.036	0.003	0	0.031
1968	0	0.038	0.003	0	0.032
1969	0	0.040	0.003	0	0.034
1970	0	0.042	0.003	0	0.035
1971	0	0.047	0.003	0	0.039
1972	0	0.052	0.004	0	0.043
1973	0	0.057	0.004	0	0.047
1974	0	0.062	0.004	0	0.050

**Table 21 Continued.** Estimates of annual exploitation rate (total biomass killed age 2+ / total biomass age 2+) by recreational fleets for Eastern Gulf of Mexico Red Snapper.

Year	Charter Closed Season Discards	Charter	Headboat	Private Closed Season Discards	Private
1975	0.000	0.018	0.005	0.000	0.089
1976	0.000	0.017	0.005	0.000	0.074
1977	0.000	0.019	0.005	0.000	0.089
1978	0.000	0.020	0.006	0.000	0.100
1979	0.000	0.021	0.006	0.000	0.102
1980	0.000	0.020	0.006	0.000	0.089
1981	0.000	0.015	0.007	0.000	0.190
1982	0.000	0.004	0.002	0.000	0.006
1983	0.000	0.035	0.018	0.000	0.372
1984	0.000	0.061	0.032	0.000	0.027
1985	0.000	0.025	0.013	0.000	0.181
1986	0.000	0.228	0.004	0.000	0.281
1987	0.000	0.018	0.002	0.000	0.225
1988	0.000	0.036	0.004	0.000	0.150
1989	0.000	0.065	0.002	0.000	0.353
1990	0.000	0.000	0.001	0.000	0.436
1991	0.000	0.002	0.004	0.000	0.356
1992	0.000	0.065	0.001	0.000	0.095
1993	0.000	0.000	0.009	0.000	0.000
1994	0.000	0.001	0.003	0.000	0.000
1995	0.000	0.000	0.001	0.000	0.065
1996	0.000	0.005	0.001	0.000	0.600
1997	0.001	0.027	0.000	0.000	0.000
1998	0.000	0.155	0.001	0.067	0.000
1999	0.000	0.012	0.017	0.032	0.131

**Table 21 Continued.** Estimates of annual exploitation rate (total biomass killed age 2+ / total biomass age 2+) by recreational fleets for Eastern Gulf of Mexico Red Snapper.

Year	Charter Closed Season Discards	Charter	Headboat	Private Closed Season Discards	Private
2000	0.000	0.005	0.005	0.002	0.035
2001	0.004	0.006	0.004	0.000	0.000
2002	0.000	0.003	0.001	0.000	0.042
2003	0.002	0.006	0.001	0.002	0.011
2004	0.001	0.001	0.003	0.035	0.028
2005	0.001	0.006	0.009	0.015	0.314
2006	0.006	0.127	0.002	0.008	0.054
2007	0.001	0.001	0.001	0.000	0.112
2008	0.005	0.006	0.002	0.011	0.009
2009	0.003	0.009	0.004	0.014	0.027
2010	0.001	0.003	0.002	0.027	0.005
2011	0.000	0.000	0.003	0.485	0.018
2012	0.000	0.002	0.004	0.004	0.025
2013	0.002	0.013	0.004	0.002	0.006
2014	0.003	0.003	0.003	0.012	0.008
2015	0.003	0.013	0.005	0.004	0.003
2016	0.008	0.007	0.003	0.106	0.028
2017	0.021	0.013	0.005	0.026	0.052
2018	0.005	0.013	0.005	0.071	0.064
2019	0.002	0.010	0.005	0.048	0.064

**Table 22.** Estimates of annual exploitation rate (total biomass killed age 2+ / total biomass age 2+) for Shrimp Trawl bycatch for Gulf of Mexico Red Snapper.

Year	Shrimp Bycatch central	Shrimp Bycatch east	Shrimp Bycatch west
1950	0.000	0.001	0.002
1951	0.000	0.001	0.002
1952	0.000	0.001	0.002
1953	0.000	0.001	0.002
1954	0.001	0.002	0.002
1955	0.001	0.002	0.002
1956	0.001	0.002	0.003
1957	0.001	0.002	0.003
1958	0.001	0.003	0.005
1959	0.001	0.003	0.005
1960	0.001	0.003	0.005
1961	0.001	0.002	0.004
1962	0.001	0.003	0.005
1963	0.001	0.004	0.006
1964	0.001	0.004	0.007
1965	0.001	0.004	0.006
1966	0.001	0.005	0.007
1967	0.001	0.005	0.009
1968	0.001	0.006	0.010
1969	0.001	0.006	0.011
1970	0.001	0.006	0.010
1971	0.001	0.006	0.012
1972	0.002	0.007	0.016
1973	0.002	0.007	0.016
1974	0.002	0.007	0.019

**Table 22 Continued.** Estimates of annual exploitation rate (total biomass killed age 2+ / total biomass age 2+) for Shrimp Trawl bycatch for Gulf of Mexico Red Snapper.

Year	Shrimp Bycatch central	Shrimp Bycatch east	Shrimp Bycatch west
1975	0.002	0.009	0.019
1976	0.002	0.016	0.024
1977	0.002	0.015	0.029
1978	0.003	0.012	0.036
1979	0.005	0.014	0.042
1980	0.003	0.011	0.033
1981	0.003	0.014	0.050
1982	0.004	0.008	0.064
1983	0.006	0.004	0.086
1984	0.010	0.006	0.133
1985	0.009	0.010	0.101
1986	0.006	0.008	0.108
1987	0.004	0.021	0.133
1988	0.009	0.016	0.087
1989	0.010	0.019	0.116
1990	0.023	0.012	0.212
1991	0.015	0.015	0.127
1992	0.013	0.028	0.094
1993	0.006	0.068	0.051
1994	0.007	0.085	0.071
1995	0.018	0.071	0.096
1996	0.012	0.091	0.096
1997	0.029	0.162	0.105
1998	0.016	0.123	0.084
1999	0.009	0.020	0.075

**Table 22 Continued.** Estimates of annual exploitation rate (total biomass killed age 2+ / total biomass age 2+) for Shrimp Trawl bycatch for Gulf of Mexico Red Snapper.

Year	Shrimp Bycatch central	Shrimp Bycatch east	Shrimp Bycatch west
2000	0.012	0.026	0.099
2001	0.013	0.043	0.097
2002	0.012	0.038	0.087
2003	0.011	0.020	0.090
2004	0.011	0.018	0.123
2005	0.009	0.013	0.098
2006	0.014	0.013	0.073
2007	0.008	0.006	0.067
2008	0.005	0.009	0.042
2009	0.002	0.003	0.028
2010	0.002	0.003	0.033
2011	0.001	0.003	0.024
2012	0.001	0.002	0.023
2013	0.002	0.002	0.020
2014	0.001	0.002	0.018
2015	0.002	0.012	0.019
2016	0.003	0.008	0.026
2017	0.002	0.007	0.015
2018	0.002	0.003	0.012
2019	0.002	0.002	0.014

**Table 23.** Expected biomass (metric tons) for all Western Gulf of Mexico Red Snapper and exploited (2+ years) Red Snapper, spawning stock biomass (SSB, metric tons), exploited numbers (1,000s of fish), age-0 recruits (1,000s of fish), and SSB ratio (SSB/SSB<sub>0</sub>) where SSB<sub>0</sub> = 307971.3 metric tons for Gulf of Mexico Red Snapper.

Year	Biomass (all)	Biomass (exploited)	SSB	Abundance (exploited)	Recruits	SSB ratio
1950	171,571	167,041	163,037	47,482	61,397	0.78
1951	170,421	165,987	162,158	46,512	61,396	0.78
1952	169,022	164,592	160,968	45,496	61,395	0.77
1953	167,185	162,772	159,303	44,474	61,393	0.76
1954	165,297	160,882	157,493	43,643	61,391	0.76
1955	163,009	158,629	155,339	42,642	61,388	0.75
1956	160,672	156,267	153,012	41,910	61,386	0.74
1957	157,515	153,147	149,970	40,870	61,381	0.72
1958	153,768	149,439	146,406	39,526	61,376	0.70
1959	148,345	144,122	141,395	37,285	61,367	0.68
1960	142,307	138,106	135,650	35,066	61,356	0.65
1961	136,029	131,787	129,432	33,368	61,342	0.62
1962	129,621	125,334	122,938	32,129	61,327	0.59
1963	123,068	118,833	116,458	30,696	61,310	0.56
1964	116,951	112,749	110,460	29,256	61,292	0.53
1965	110,239	106,109	104,004	27,405	61,271	0.50
1966	103,874	99,682	97,639	26,101	61,248	0.47
1967	97,947	93,762	91,717	25,057	61,224	0.44
1968	91,409	87,280	85,328	23,563	61,196	0.41
1969	84,496	80,394	78,579	21,893	61,163	0.38
1970	77,974	73,927	72,257	20,258	61,127	0.35
1971	71,776	67,663	66,030	19,084	61,086	0.32
1972	65,206	61,119	59,529	17,766	61,035	0.29
1973	58,489	54,508	53,081	15,996	60,973	0.26
1974	51,961	47,949	46,646	14,467	60,893	0.22



**Table 23 Continued.** Expected biomass (metric tons) for all Western Gulf of Mexico Red Snapper and exploited (2+ years) Red Snapper, spawning stock biomass (SSB, metric tons), exploited numbers (1,000s of fish), age-0 recruits (1,000s of fish), and SSB ratio (SSB/SSB<sub>0</sub>) where SSB<sub>0</sub> = 307971.3 metric tons for Gulf of Mexico Red Snapper.

Year	Biomass (all)	Biomass (exploited)	SSB	Abundance (exploited)	Recruits	SSB ratio
1975	45,755	41,742	40,521	13,092	61,919	0.20
1976	40,204	36,055	34,862	12,062	63,603	0.17
1977	35,419	31,260	30,093	11,172	62,481	0.14
1978	31,231	27,240	26,083	10,446	57,336	0.12
1979	27,082	23,510	22,430	9,412	51,434	0.11
1980	23,127	19,686	18,809	7,897	61,302	0.09
1981	20,508	16,306	15,598	7,053	68,180	0.07
1982	17,215	12,847	12,160	6,468	63,300	0.06
1983	15,766	11,515	10,542	7,083	66,688	0.05
1984	12,935	8,720	8,022	5,601	64,138	0.04
1985	11,427	7,814	7,062	5,586	45,274	0.03
1986	10,340	7,181	6,250	5,775	55,595	0.03
1987	9,294	6,103	5,459	4,799	37,359	0.03
1988	8,633	6,367	5,451	5,494	31,254	0.03
1989	9,303	5,625	4,894	4,549	112,268	0.02
1990	11,770	5,240	5,185	4,110	70,417	0.03
1991	12,321	7,731	6,016	9,504	65,117	0.03
1992	13,125	9,457	7,516	10,121	32,649	0.04
1993	13,077	10,468	8,548	9,884	54,972	0.04
1994	14,770	10,175	9,073	7,821	99,324	0.04
1995	16,436	10,259	9,439	8,135	74,158	0.04
1996	16,759	11,971	9,973	11,778	63,328	0.05
1997	17,206	13,008	10,909	11,686	65,101	0.05
1998	16,403	12,481	10,987	9,675	57,341	0.05
1999	16,013	11,735	10,472	8,732	87,104	0.05

**Table 23 Continued.** Expected biomass (metric tons) for all Western Gulf of Mexico Red Snapper and exploited (2+ years) Red Snapper, spawning stock biomass (SSB, metric tons), exploited numbers (1,000s of fish), age-0 recruits (1,000s of fish), and SSB ratio (SSB/SSB<sub>0</sub>) where SSB<sub>0</sub> = 307971.3 metric tons for Gulf of Mexico Red Snapper.

Year	Biomass (all)	Biomass (exploited)	SSB	Abundance (exploited)	Recruits	SSB ratio
2000	16,593	11,289	10,278	8,429	65,988	0.05
2001	15,924	11,823	10,165	10,202	54,355	0.05
2002	15,475	11,935	10,325	9,567	56,966	0.05
2003	15,622	11,435	10,212	8,306	84,916	0.05
2004	16,618	10,873	9,976	7,795	99,558	0.05
2005	17,211	10,827	9,673	8,936	99,060	0.05
2006	18,425	11,803	9,971	11,437	97,166	0.05
2007	19,599	13,164	10,693	13,845	84,172	0.05
2008	20,945	16,428	13,185	16,984	20,303	0.06
2009	23,644	20,504	16,597	18,986	105,263	0.08
2010	28,864	22,698	20,767	15,427	52,326	0.10
2011	31,744	27,511	24,369	20,418	81,467	0.12
2012	36,762	30,696	28,035	19,514	102,292	0.14
2013	41,057	34,713	31,896	21,753	63,098	0.15
2014	43,328	38,760	34,853	25,179	69,627	0.17
2015	47,638	41,887	38,408	24,228	114,180	0.18
2016	51,330	44,079	41,304	23,816	81,952	0.20
2017	53,522	48,266	44,582	27,109	64,072	0.21
2018	56,942	51,523	47,676	27,408	110,564	0.23
2019	61,228	54,101	51,029	26,604	79,721	0.24

**Table 24.** Expected biomass (metric tons) for all Central Gulf of Mexico Red Snapper and exploited (2+ years) Red Snapper, spawning stock biomass (SSB, metric tons), exploited numbers (1,000s of fish), age-0 recruits (1,000s of fish), and SSB ratio (SSB/SSB<sub>0</sub>) where SSB<sub>0</sub> = 307971.3 metric tons for Gulf of Mexico Red Snapper.

Year	Biomass (all)	Biomass (exploited)	SSB	Abundance (exploited)	Recruits	SSB ratio
1950	37,502	36,044	35,475	10,515	18,601	0.46
1951	37,664	36,210	35,635	10,565	18,600	0.47
1952	37,723	36,272	35,705	10,546	18,600	0.47
1953	37,694	36,245	35,686	10,493	18,599	0.47
1954	37,702	36,254	35,697	10,468	18,599	0.47
1955	37,723	36,277	35,723	10,447	18,598	0.47
1956	37,653	36,210	35,662	10,389	18,597	0.47
1957	37,277	35,837	35,304	10,228	18,596	0.46
1958	36,785	35,347	34,823	10,066	18,594	0.45
1959	35,690	34,253	33,751	9,710	18,591	0.44
1960	34,485	33,050	32,560	9,386	18,588	0.42
1961	33,008	31,571	31,093	9,020	18,584	0.41
1962	31,583	30,142	29,663	8,742	18,580	0.39
1963	30,085	28,649	28,177	8,436	18,574	0.37
1964	28,518	27,082	26,621	8,111	18,569	0.35
1965	27,060	25,626	25,170	7,839	18,562	0.33
1966	25,667	24,232	23,787	7,561	18,556	0.31
1967	24,509	23,074	22,626	7,395	18,548	0.30
1968	23,284	21,849	21,407	7,173	18,540	0.28
1969	22,236	20,805	20,365	7,009	18,530	0.27
1970	21,258	19,826	19,390	6,851	18,519	0.25
1971	20,388	18,957	18,522	6,726	18,506	0.24
1972	19,396	17,964	17,536	6,534	18,491	0.23
1973	18,253	16,823	16,410	6,270	18,472	0.21
1974	16,769	15,343	14,958	5,847	18,448	0.20

**Table 24 Continued.** Expected biomass (metric tons) for all Central Gulf of Mexico Red Snapper and exploited (2+ years) Red Snapper, spawning stock biomass (SSB, metric tons), exploited numbers (1,000s of fish), age-0 recruits (1,000s of fish), and SSB ratio (SSB/SSB<sub>0</sub>) where SSB<sub>0</sub> = 307971.3 metric tons for Gulf of Mexico Red Snapper.

Year	Biomass (all)	Biomass (exploited)	SSB	Abundance (exploited)	Recruits	SSB ratio
1975	15,079	13,751	13,388	5,415	13,153	0.17
1976	13,267	12,226	11,833	4,985	14,464	0.15
1977	11,500	10,346	10,094	4,089	16,365	0.13
1978	10,078	8,727	8,521	3,600	21,167	0.11
1979	9,174	7,476	7,293	3,409	24,689	0.10
1980	8,565	6,862	6,610	3,712	13,901	0.09
1981	7,872	6,833	6,333	4,320	11,769	0.08
1982	6,747	5,738	5,478	3,149	17,240	0.07
1983	6,253	4,979	4,844	2,692	14,292	0.06
1984	4,398	3,296	3,146	2,084	14,528	0.04
1985	4,352	3,314	3,112	2,319	10,455	0.04
1986	3,953	3,263	3,003	2,415	4,331	0.04
1987	3,665	3,206	2,928	2,280	11,151	0.04
1988	3,099	2,322	2,294	1,347	6,960	0.03
1989	2,954	2,147	1,985	1,576	21,746	0.03
1990	3,477	1,818	1,874	1,248	21,313	0.02
1991	3,965	2,311	2,072	2,473	22,342	0.03
1992	4,340	2,753	2,445	2,997	15,139	0.03
1993	4,214	3,160	2,739	3,355	9,139	0.04
1994	3,216	2,313	2,043	2,273	19,932	0.03
1995	3,298	1,826	1,795	1,633	16,566	0.02
1996	4,162	2,365	2,024	2,781	44,738	0.03
1997	5,805	2,522	2,478	2,915	34,959	0.03
1998	6,249	3,838	3,110	5,471	19,633	0.04
1999	6,949	5,177	4,220	6,353	33,632	0.06

**Table 24 Continued.** Expected biomass (metric tons) for all Central Gulf of Mexico Red Snapper and exploited (2+ years) Red Snapper, spawning stock biomass (SSB, metric tons), exploited numbers (1,000s of fish), age-0 recruits (1,000s of fish), and SSB ratio (SSB/SSB<sub>0</sub>) where SSB<sub>0</sub> = 307971.3 metric tons for Gulf of Mexico Red Snapper.

Year	Biomass (all)	Biomass (exploited)	SSB	Abundance (exploited)	Recruits	SSB ratio
2000	7,624	4,868	4,480	4,845	42,650	0.06
2001	8,427	5,235	4,769	5,514	37,321	0.06
2002	8,696	5,851	5,067	6,614	35,430	0.07
2003	7,890	5,053	4,407	5,761	41,383	0.06
2004	7,960	4,870	4,323	5,587	35,664	0.06
2005	8,528	4,662	3,969	5,780	95,569	0.05
2006	12,065	5,020	4,991	5,925	75,015	0.06
2007	15,005	9,109	7,387	12,716	78,302	0.10
2008	16,847	12,014	10,187	14,625	11,991	0.13
2009	19,254	17,439	14,649	18,056	59,862	0.19
2010	22,870	18,851	18,078	13,410	26,542	0.24
2011	22,879	20,855	19,300	15,040	24,455	0.25
2012	22,342	19,875	18,759	12,406	55,329	0.24
2013	22,543	18,733	18,271	10,599	29,126	0.24
2014	20,305	17,593	16,232	12,078	53,581	0.21
2015	22,988	18,384	17,539	11,509	76,864	0.23
2016	26,077	19,859	18,868	13,538	89,672	0.25
2017	28,160	22,092	20,478	17,081	41,303	0.27
2018	26,004	22,338	19,705	19,335	66,101	0.26
2019	29,076	24,500	22,970	17,637	35,640	0.30

**Table 25.** Expected biomass (metric tons) for all East Gulf of Mexico Red Snapper and exploited (2+ years) Red Snapper, spawning stock biomass (SSB, metric tons), exploited numbers (1,000s of fish), age-0 recruits (1,000s of fish), and SSB ratio ( $SSB/SSB_0$ ) where  $SSB_0 = 307971.3$  metric tons for Gulf of Mexico Red Snapper.

Year	Biomass (all)	Biomass (exploited)	SSB	Abundance (exploited)	Recruits	SSB ratio
1950	10,528	10,189	10,010	2,902	5,164	0.43
1951	10,642	10,306	10,128	2,911	5,164	0.44
1952	10,674	10,341	10,170	2,884	5,164	0.44
1953	10,642	10,309	10,144	2,842	5,164	0.44
1954	10,628	10,295	10,134	2,812	5,163	0.44
1955	10,615	10,284	10,127	2,780	5,163	0.44
1956	10,524	10,195	10,043	2,729	5,163	0.43
1957	10,293	9,966	9,821	2,642	5,163	0.42
1958	10,054	9,727	9,588	2,561	5,162	0.41
1959	9,485	9,159	9,027	2,417	5,161	0.39
1960	8,928	8,603	8,476	2,289	5,160	0.37
1961	8,267	7,942	7,817	2,157	5,159	0.34
1962	7,680	7,351	7,223	2,073	5,158	0.31
1963	7,073	6,748	6,622	1,967	5,157	0.29
1964	6,445	6,119	5,997	1,854	5,155	0.26
1965	5,815	5,491	5,373	1,736	5,153	0.23
1966	5,269	4,944	4,830	1,635	5,151	0.21
1967	4,824	4,499	4,385	1,565	5,149	0.19
1968	4,584	4,258	4,142	1,548	5,147	0.18
1969	4,337	4,013	3,900	1,505	5,144	0.17
1970	4,157	3,832	3,720	1,479	5,141	0.16
1971	3,984	3,659	3,548	1,453	5,138	0.15
1972	3,867	3,542	3,429	1,442	5,133	0.15
1973	3,705	3,381	3,271	1,406	5,128	0.14
1974	3,568	3,244	3,137	1,372	5,122	0.14

**Table 25 Continued.** Expected biomass (metric tons) for all East Gulf of Mexico Red Snapper and exploited (2+ years) Red Snapper, spawning stock biomass (SSB, metric tons), exploited numbers (1,000s of fish), age-0 recruits (1,000s of fish), and SSB ratio (SSB/SSB<sub>0</sub>) where SSB<sub>0</sub> = 307971.3 metric tons for Gulf of Mexico Red Snapper.

Year	Biomass (all)	Biomass (exploited)	SSB	Abundance (exploited)	Recruits	SSB ratio
1975	3,027	2,633	2,538	1,183	9,243	0.11
1976	2,687	2,157	2,106	1,041	6,069	0.09
1977	2,348	1,980	1,828	1,297	5,077	0.08
1978	2,312	1,990	1,851	1,252	5,186	0.08
1979	2,367	2,003	1,900	1,161	7,300	0.08
1980	2,458	1,989	1,915	1,106	7,906	0.08
1981	2,585	2,166	2,050	1,330	2,839	0.09
1982	2,332	2,173	2,011	1,336	1,677	0.09
1983	2,480	2,389	2,270	1,214	884	0.10
1984	1,499	1,428	1,397	566	1,819	0.06
1985	1,260	1,159	1,150	405	1,228	0.05
1986	932	856	839	312	1,302	0.04
1987	525	454	449	165	717	0.02
1988	421	367	354	156	1,325	0.01
1989	370	302	298	130	560	0.01
1990	256	225	213	120	304	0.01
1991	121	103	96	67	260	0.00
1992	103	81	76	52	579	0.00
1993	128	86	84	54	903	0.00
1994	156	101	96	76	944	0.00
1995	199	141	129	116	1,019	0.01
1996	252	172	159	136	2,169	0.01
1997	250	124	124	103	2,178	0.00
1998	309	204	184	206	684	0.01
1999	315	264	227	245	1,389	0.01

**Table 25 Continued.** Expected biomass (metric tons) for all East Gulf of Mexico Red Snapper and exploited (2+ years) Red Snapper, spawning stock biomass (SSB, metric tons), exploited numbers (1,000s of fish), age-0 recruits (1,000s of fish), and SSB ratio (SSB/SSB<sub>0</sub>) where SSB<sub>0</sub> = 307971.3 metric tons for Gulf of Mexico Red Snapper.

Year	Biomass (all)	Biomass (exploited)	SSB	Abundance (exploited)	Recruits	SSB ratio
2000	383	281	266	200	2,325	0.01
2001	511	364	347	263	2,337	0.01
2002	644	505	465	389	1,984	0.02
2003	799	659	609	463	3,072	0.03
2004	1,025	836	796	517	2,942	0.03
2005	1,267	1,031	970	647	5,898	0.04
2006	1,322	973	935	634	4,393	0.04
2007	1,559	1,221	1,093	1,006	7,618	0.05
2008	2,021	1,622	1,504	1,215	2,087	0.06
2009	2,473	2,340	2,099	1,749	1,998	0.09
2010	3,033	2,873	2,721	1,585	3,831	0.12
2011	3,522	3,293	3,220	1,448	2,897	0.14
2012	2,287	2,110	2,031	1,001	2,455	0.09
2013	2,477	2,344	2,250	1,074	974	0.10
2014	2,898	2,512	2,412	1,079	19,828	0.10
2015	3,732	2,535	2,640	923	14,605	0.11
2016	4,166	3,303	2,942	2,712	9,789	0.13
2017	4,627	4,105	3,608	3,399	3,309	0.16
2018	5,167	4,960	4,523	3,424	3,029	0.20
2019	5,439	5,170	4,947	2,701	7,493	0.21



**Table 26.** Input (with log-scale standard errors, SE) and expected (Exp) landings for the Commercial Handline West fleet in weight (B, million pounds whole weight) and number (1,000s of fish) for Gulf of Mexico Red Snapper. The mean body weight (MW, whole pounds per fish) was determined by dividing the expected landings in weights by the expected landings in numbers.

Year	Input B SE	Input B	Exp B	Exp N	MW
1950	0.05	1.48	1.48	253	5.8
1951	0.05	1.48	1.48	250	5.9
1952	0.05	1.65	1.65	277	6.0
1953	0.05	1.36	1.36	226	6.0
1954	0.05	1.37	1.37	226	6.1
1955	0.05	1.49	1.49	246	6.1
1956	0.05	2.02	2.02	332	6.1
1957	0.05	2.01	2.01	330	6.1
1958	0.05	3.36	3.36	544	6.2
1959	0.05	3.43	3.43	547	6.3
1960	0.05	3.60	3.60	571	6.3
1961	0.05	4.25	4.25	679	6.3
1962	0.05	4.13	4.14	671	6.2
1963	0.05	3.00	3.00	493	6.1
1964	0.05	3.59	3.60	593	6.1
1965	0.05	3.65	3.65	608	6.0
1966	0.05	3.04	3.04	518	5.9
1967	0.05	4.23	4.24	735	5.8
1968	0.05	5.16	5.17	910	5.7
1969	0.05	4.19	4.20	748	5.6
1970	0.05	4.65	4.66	850	5.5
1971	0.05	5.37	5.38	1,015	5.3
1972	0.05	4.84	4.86	940	5.2
1973	0.05	4.87	4.89	968	5.0
1974	0.05	4.43	4.45	919	4.8

**Table 26 Continued.** Input (with log-scale standard errors, SE) and expected (Exp) landings for the Commercial Handline West fleet in weight (B, million pounds whole weight) and number (1,000s of fish) for Gulf of Mexico Red Snapper. The mean body weight (MW, whole pounds per fish) was determined by dividing the expected landings in weights by the expected landings in numbers.

Year	Input B SE	Input B	Exp B	Exp N	MW
1975	0.05	3.93	3.95	861	4.6
1976	0.05	3.33	3.34	779	4.3
1977	0.05	2.87	2.88	719	4.0
1978	0.05	2.69	2.70	708	3.8
1979	0.05	2.47	2.48	660	3.8
1980	0.05	2.52	2.53	691	3.7
1981	0.05	3.14	3.16	989	3.2
1982	0.05	3.66	3.68	1,327	2.8
1983	0.05	3.82	3.84	1,466	2.6
1984	0.05	2.91	2.94	1,205	2.4
1985	0.05	1.85	1.86	602	3.1
1986	0.05	1.93	1.94	629	3.1
1987	0.05	1.47	1.48	497	3.0
1988	0.05	2.35	2.35	765	3.1
1989	0.05	1.89	1.89	598	3.2
1990	0.05	1.76	1.75	695	2.5
1991	0.05	1.73	1.72	659	2.6
1992	0.05	2.67	2.64	948	2.8
1993	0.05	2.90	2.82	915	3.1
1994	0.05	2.67	2.58	809	3.2
1995	0.20	2.73	1.79	500	3.6
1996	0.20	4.04	2.51	711	3.5
1997	0.20	4.59	3.26	888	3.7
1998	0.20	4.27	3.54	916	3.9
1999	0.20	4.23	3.49	879	4.0

**Table 26 Continued.** Input (with log-scale standard errors, SE) and expected (Exp) landings for the Commercial Handline West fleet in weight (B, million pounds whole weight) and number (1,000s of fish) for Gulf of Mexico Red Snapper. The mean body weight (MW, whole pounds per fish) was determined by dividing the expected landings in weights by the expected landings in numbers.

Year	Input B SE	Input B	Exp B	Exp N	MW
2000	0.16	3.98	3.86	1,010	3.8
2001	0.17	3.71	3.72	980	3.8
2002	0.17	3.57	3.63	929	3.9
2003	0.17	3.21	3.63	901	4.0
2004	0.18	3.22	3.60	920	3.9
2005	0.18	3.00	3.59	981	3.7
2006	0.18	3.62	4.87	1,427	3.4
2007	0.05	2.10	2.16	658	3.3
2008	0.05	1.58	1.60	473	3.4
2009	0.05	1.50	1.53	411	3.7
2010	0.05	1.88	1.90	490	3.9
2011	0.05	1.88	1.90	467	4.1
2012	0.05	2.12	2.15	514	4.2
2013	0.05	3.00	3.00	717	4.2
2014	0.05	3.26	3.20	750	4.3
2015	0.05	3.97	3.90	892	4.4
2016	0.05	3.95	3.89	886	4.4
2017	0.05	4.00	3.94	886	4.4
2018	0.05	3.94	3.88	857	4.5
2019	0.05	4.12	4.05	898	4.5

**Table 27.** Input (with log-scale standard errors, SE) and expected (Exp) landings for the Commercial Handline Central fleet in weight (B, million pounds whole weight) and number (1,000s of fish) for Gulf of Mexico Red Snapper. The mean body weight (MW, whole pounds per fish) was determined by dividing the expected landings in weights by the expected landings in numbers.

Year	Input B SE	Input B	Exp B	Exp N	MW
1950	0.05	0.97	0.97	244	4.0
1951	0.05	1.16	1.16	289	4.0
1952	0.05	1.29	1.29	321	4.0
1953	0.05	1.16	1.16	289	4.0
1954	0.05	1.08	1.08	268	4.0
1955	0.05	1.21	1.21	299	4.0
1956	0.05	1.44	1.45	357	4.0
1957	0.05	1.30	1.30	320	4.0
1958	0.05	2.13	2.13	528	4.0
1959	0.05	1.95	1.95	487	4.0
1960	0.05	2.19	2.19	552	4.0
1961	0.05	2.01	2.01	517	3.9
1962	0.05	2.07	2.07	544	3.8
1963	0.05	2.19	2.19	587	3.7
1964	0.05	1.95	1.95	534	3.7
1965	0.05	2.09	2.09	584	3.6
1966	0.05	1.66	1.66	475	3.5
1967	0.05	1.88	1.88	550	3.4
1968	0.05	1.55	1.56	463	3.4
1969	0.05	1.50	1.50	455	3.3
1970	0.05	1.36	1.36	419	3.2
1971	0.05	1.42	1.43	446	3.2
1972	0.05	1.51	1.51	481	3.1
1973	0.05	1.95	1.96	635	3.1
1974	0.05	1.94	1.95	651	3.0

**Table 27 Continued.** Input (with log-scale standard errors, SE) and expected (Exp) landings for the Commercial Handline Central fleet in weight (B, million pounds whole weight) and number (1,000s of fish) for Gulf of Mexico Red Snapper. The mean body weight (MW, whole pounds per fish) was determined by dividing the expected landings in weights by the expected landings in numbers.

Year	Input B SE	Input B	Exp B	Exp N	MW
1975	0.05	1.96	1.97	680	2.9
1976	0.05	1.74	1.75	579	3.0
1977	0.05	1.35	1.35	469	2.9
1978	0.05	1.24	1.24	474	2.6
1979	0.05	1.28	1.28	567	2.3
1980	0.05	1.30	1.30	638	2.0
1981	0.05	1.57	1.57	678	2.3
1982	0.05	1.75	1.76	718	2.5
1983	0.05	1.95	1.96	922	2.1
1984	0.05	1.23	1.24	631	2.0
1985	0.05	1.21	1.22	434	2.8
1986	0.05	0.72	0.72	250	2.9
1987	0.05	0.69	0.69	215	3.2
1988	0.05	0.75	0.75	252	3.0
1989	0.05	0.61	0.61	205	3.0
1990	0.05	0.58	0.58	245	2.4
1991	0.05	0.37	0.37	164	2.3
1992	0.05	0.39	0.39	170	2.3
1993	0.05	0.40	0.40	135	3.0
1994	0.05	0.50	0.50	159	3.1
1995	0.18	0.16	0.17	46	3.6
1996	0.18	0.22	0.22	66	3.4
1997	0.18	0.18	0.18	59	3.0
1998	0.18	0.37	0.36	119	3.0
1999	0.16	0.50	0.51	153	3.3

**Table 27 Continued.** Input (with log-scale standard errors, SE) and expected (Exp) landings for the Commercial Handline Central fleet in weight (B, million pounds whole weight) and number (1,000s of fish) for Gulf of Mexico Red Snapper. The mean body weight (MW, whole pounds per fish) was determined by dividing the expected landings in weights by the expected landings in numbers.

Year	Input B SE	Input B	Exp B	Exp N	MW
2000	0.16	0.63	0.64	184	3.5
2001	0.16	0.75	0.73	212	3.5
2002	0.15	1.02	0.99	294	3.4
2003	0.15	0.97	0.97	291	3.3
2004	0.15	0.90	0.91	281	3.2
2005	0.15	0.72	0.75	233	3.2
2006	0.15	0.67	0.69	231	3.0
2007	0.05	0.82	0.83	339	2.5
2008	0.05	0.76	0.75	278	2.7
2009	0.05	0.81	0.82	248	3.3
2010	0.05	1.19	1.20	322	3.7
2011	0.05	1.36	1.39	338	4.1
2012	0.05	1.61	1.65	372	4.4
2013	0.05	1.99	1.96	455	4.3
2014	0.05	1.71	1.71	402	4.3
2015	0.05	2.37	2.32	564	4.1
2016	0.05	2.12	2.07	542	3.8
2017	0.05	2.24	2.20	629	3.5
2018	0.05	2.10	2.06	573	3.6
2019	0.05	2.21	2.18	577	3.8

**Table 28.** Input (with log-scale standard errors, SE) and expected (Exp) landings for the Commercial Handline East fleet in weight (B, million pounds whole weight) and number (1,000s of fish) for Gulf of Mexico Red Snapper. The mean body weight (MW, whole pounds per fish) was determined by dividing the expected landings in weights by the expected landings in numbers.

Year	Input B SE	Input B	Exp B	Exp N	MW
1950	0.05	0.72	0.72	85	8.5
1951	0.05	0.86	0.86	100	8.5
1952	0.05	0.96	0.96	111	8.6
1953	0.05	0.86	0.86	99	8.7
1954	0.05	0.80	0.80	91	8.8
1955	0.05	0.90	0.90	101	8.9
1956	0.05	1.08	1.07	120	8.9
1957	0.05	0.97	0.96	107	9.0
1958	0.05	1.59	1.58	175	9.0
1959	0.05	1.46	1.45	160	9.0
1960	0.05	1.63	1.62	181	8.9
1961	0.05	1.50	1.48	170	8.7
1962	0.05	1.54	1.53	181	8.4
1963	0.05	1.63	1.61	197	8.2
1964	0.05	1.66	1.64	208	7.9
1965	0.05	1.62	1.60	212	7.6
1966	0.05	1.44	1.42	196	7.2
1967	0.05	1.02	1.01	146	6.9
1968	0.05	1.06	1.05	157	6.7
1969	0.05	0.94	0.93	144	6.5
1970	0.05	0.95	0.94	149	6.3
1971	0.05	0.80	0.79	128	6.2
1972	0.05	0.87	0.86	142	6.0
1973	0.05	0.76	0.75	127	5.9
1974	0.05	1.82	1.78	310	5.8

**Table 28 Continued.** Input (with log-scale standard errors, SE) and expected (Exp) landings for the Commercial Handline East fleet in weight (B, million pounds whole weight) and number (1,000s of fish) for Gulf of Mexico Red Snapper. The mean body weight (MW, whole pounds per fish) was determined by dividing the expected landings in weights by the expected landings in numbers.

Year	Input B SE	Input B	Exp B	Exp N	MW
1975	0.05	1.62	1.58	292	5.4
1976	0.05	1.55	1.52	335	4.5
1977	0.05	0.92	0.91	221	4.1
1978	0.05	0.76	0.75	179	4.2
1979	0.05	0.76	0.75	170	4.4
1980	0.05	0.59	0.59	136	4.3
1981	0.05	0.56	0.55	133	4.2
1982	0.05	0.54	0.54	118	4.5
1983	0.05	0.43	0.43	82	5.3
1984	0.05	0.40	0.40	64	6.3
1985	0.05	0.41	0.41	58	7.1
1986	0.05	0.14	0.14	19	7.2
1987	0.05	0.10	0.10	15	6.8
1988	0.05	0.11	0.11	16	6.5
1989	0.05	0.06	0.06	11	5.8
1990	0.05	0.12	0.12	24	5.1
1991	0.05	0.02	0.02	6	4.5
1992	0.05	0.01	0.01	3	4.5
1993	0.05	0.04	0.04	8	4.6
1994	0.05	0.02	0.02	6	4.1
1995	0.15	0.01	0.01	3	4.9
1996	0.15	0.01	0.01	2	4.8
1997	0.15	0.01	0.01	2	4.6
1998	0.15	0.01	0.01	3	4.4
1999	0.15	0.05	0.05	11	4.4



**Table 28 Continued.** Input (with log-scale standard errors, SE) and expected (Exp) landings for the Commercial Handline East fleet in weight (B, million pounds whole weight) and number (1,000s of fish) for Gulf of Mexico Red Snapper. The mean body weight (MW, whole pounds per fish) was determined by dividing the expected landings in weights by the expected landings in numbers.

Year	Input B SE	Input B	Exp B	Exp N	MW
2000	0.15	0.03	0.03	7	4.8
2001	0.15	0.04	0.04	7	5.2
2002	0.15	0.04	0.04	7	5.2
2003	0.15	0.05	0.06	11	5.3
2004	0.15	0.05	0.06	10	5.6
2005	0.15	0.07	0.08	13	5.8
2006	0.15	0.10	0.09	17	5.6
2007	0.05	0.06	0.06	11	5.1
2008	0.05	0.06	0.06	11	5.0
2009	0.05	0.11	0.11	21	5.2
2010	0.05	0.21	0.21	37	5.7
2011	0.05	0.25	0.26	40	6.4
2012	0.05	0.24	0.24	36	6.7
2013	0.05	0.30	0.31	45	6.8
2014	0.05	0.41	0.41	59	6.9
2015	0.05	0.54	0.53	79	6.7
2016	0.05	0.40	0.40	75	5.3
2017	0.05	0.49	0.49	105	4.7
2018	0.05	0.57	0.56	112	5.0
2019	0.05	0.75	0.74	130	5.7

**Table 29.** Input (with log-scale standard errors, SE) and expected (Exp) landings for the Commercial Longline West fleet in weight (B, million pounds whole weight) and number (1,000s of fish) for Gulf of Mexico Red Snapper. The mean body weight (MW, whole pounds per fish) was determined by dividing the expected landings in weights by the expected landings in numbers.

Year	Input B SE	Input B	Exp B	Exp N	MW
1980	0.05	0.04	0.04	4	11.1
1981	0.05	0.05	0.05	5	10.4
1982	0.05	0.07	0.07	8	9.5
1983	0.05	0.10	0.10	11	8.8
1984	0.05	0.76	0.76	95	8.0
1985	0.05	0.60	0.61	70	8.6
1986	0.05	0.83	0.83	103	8.1
1987	0.05	0.73	0.73	99	7.4
1988	0.05	0.67	0.67	92	7.3
1989	0.05	0.46	0.46	63	7.2
1990	0.05	0.12	0.12	20	6.0
1991	0.05	0.07	0.07	13	5.7
1992	0.05	0.02	0.02	3	5.8
1993	0.05	0.02	0.02	2	8.3
1994	0.05	0.02	0.02	2	8.5
1995	0.20	0.02	0.02	2	9.0
1996	0.20	0.03	0.03	3	9.1
1997	0.20	0.03	0.03	3	9.2
1998	0.20	0.03	0.03	3	9.4
1999	0.20	0.09	0.10	10	9.7
2000	0.16	0.18	0.17	18	9.7
2001	0.17	0.12	0.12	12	9.7
2002	0.17	0.15	0.14	15	9.8
2003	0.17	0.17	0.17	18	10.0
2004	0.18	0.46	0.43	43	10.0

**Table 29 Continued.** Input (with log-scale standard errors, SE) and expected (Exp) landings for the Commercial Longline West fleet in weight (B, million pounds whole weight) and number (1,000s of fish) for Gulf of Mexico Red Snapper. The mean body weight (MW, whole pounds per fish) was determined by dividing the expected landings in weights by the expected landings in numbers.

Year	Input B SE	Input B	Exp B	Exp N	MW
2005	0.18	0.28	0.27	28	9.8
2006	0.18	0.26	0.25	26	9.4
2007	0.05	0.19	0.19	19	10.0
2008	0.05	0.06	0.06	6	9.6
2009	0.05	0.05	0.05	5	9.6
2010	0.05	0.04	0.04	4	9.8
2011	0.05	0.02	0.02	2	10.1
2012	0.05	0.01	0.01	1	10.4
2013	0.05	0.05	0.05	5	10.7
2014	0.05	0.06	0.06	5	11.0
2015	0.05	0.05	0.05	4	11.3
2016	0.05	0.07	0.07	6	11.5
2017	0.05	0.07	0.07	6	11.7
2018	0.05	0.07	0.07	6	11.9
2019	0.05	0.16	0.16	13	12.1

**Table 30.** Input (with log-scale standard errors, SE) and expected (Exp) landings for the Commercial Longline Central fleet in weight (B, million pounds whole weight) and number (1,000s of fish) for Gulf of Mexico Red Snapper. The mean body weight (MW, whole pounds per fish) was determined by dividing the expected landings in weights by the expected landings in numbers.

Year	Input B SE	Input B	Exp B	Exp N	MW
1980	0.05	0.06	0.06	7	8.5
1981	0.05	0.09	0.09	10	8.5
1982	0.05	0.08	0.08	10	8.4
1983	0.05	0.11	0.11	14	7.9
1984	0.05	0.10	0.10	14	7.4
1985	0.05	0.03	0.03	4	8.0
1986	0.05	0.03	0.03	4	7.6
1987	0.05	0.03	0.03	4	7.7
1988	0.05	0.05	0.05	7	7.5
1989	0.05	0.06	0.06	7	7.5
1990	0.05	0.01	0.01	2	6.3
1991	0.05	0.01	0.01	1	5.4
1992	0.05	0.00	0.00	0	4.9
1993	0.05	0.00	0.00	0	7.0
1994	0.05	0.00	0.00	0	7.0
1995	0.18	0.00	0.00	0	7.1
1996	0.18	0.00	0.00	1	6.7
1997	0.18	0.00	0.00	0	5.9
1998	0.18	0.00	0.00	0	5.5
1999	0.16	0.00	0.00	0	5.8
2000	0.16	0.00	0.00	0	6.2
2001	0.16	0.00	0.00	0	6.5
2002	0.15	0.01	0.01	1	6.4
2003	0.15	0.00	0.00	1	6.2
2004	0.15	0.00	0.00	1	6.0

**Table 30 Continued.** Input (with log-scale standard errors, SE) and expected (Exp) landings for the Commercial Longline Central fleet in weight (B, million pounds whole weight) and number (1,000s of fish) for Gulf of Mexico Red Snapper. The mean body weight (MW, whole pounds per fish) was determined by dividing the expected landings in weights by the expected landings in numbers.

Year	Input B SE	Input B	Exp B	Exp N	MW
2005	0.15	0.00	0.00	0	5.9
2006	0.15	0.00	0.00	0	5.6
2007	0.05	0.01	0.01	2	6.3
2008	0.05	0.02	0.02	3	6.5
2009	0.05	0.01	0.01	1	7.3
2010	0.05	0.01	0.01	1	8.2
2011	0.05	0.00	0.00	1	9.0
2012	0.05	0.00	0.00	0	9.7
2013	0.05	0.00	0.00	0	10.2
2014	0.05	0.01	0.01	1	10.6
2015	0.05	0.04	0.04	4	10.7
2016	0.05	0.02	0.02	2	10.7
2017	0.05	0.01	0.01	1	10.4
2018	0.05	0.05	0.04	4	10.0
2019	0.05	0.03	0.03	3	9.8

**Table 31.** Input (with log-scale standard errors, SE) and expected (Exp) landings for the Commercial Longline East fleet in weight (B, million pounds whole weight) and number (1,000s of fish) for Gulf of Mexico Red Snapper. The mean body weight (MW, whole pounds per fish) was determined by dividing the expected landings in weights by the expected landings in numbers.

Year	Input B SE	Input B	Exp B	Exp N	MW
1980	0.05	0.03	0.03	4	7.8
1981	0.05	0.09	0.09	12	7.8
1982	0.05	0.14	0.14	18	7.9
1983	0.05	0.34	0.34	41	8.1
1984	0.05	0.26	0.26	30	8.7
1985	0.05	0.08	0.08	9	9.4
1986	0.05	0.04	0.04	4	10.1
1987	0.05	0.04	0.04	3	10.4
1988	0.05	0.02	0.02	2	10.3
1989	0.05	0.02	0.02	2	9.9
1990	0.05	0.06	0.06	7	9.2
1991	0.05	0.01	0.01	2	8.0
1992	0.05	0.00	0.00	1	7.6
1993	0.05	0.01	0.01	2	7.1
1994	0.05	0.00	0.00	1	6.4
1995	0.15	0.01	0.01	1	6.9
1996	0.15	0.00	0.00	1	6.6
1997	0.15	0.00	0.00	1	6.2
1998	0.15	0.00	0.00	1	5.8
1999	0.15	0.01	0.01	1	5.7
2000	0.15	0.01	0.01	1	6.2
2001	0.15	0.01	0.01	2	6.7
2002	0.15	0.01	0.01	2	6.9
2003	0.15	0.01	0.01	2	7.1
2004	0.15	0.02	0.02	2	7.5

**Table 31 Continued.** Input (with log-scale standard errors, SE) and expected (Exp) landings for the Commercial Longline East fleet in weight (B, million pounds whole weight) and number (1,000s of fish) for Gulf of Mexico Red Snapper. The mean body weight (MW, whole pounds per fish) was determined by dividing the expected landings in weights by the expected landings in numbers.

Year	Input B SE	Input B	Exp B	Exp N	MW
2005	0.15	0.02	0.02	3	7.8
2006	0.15	0.02	0.02	2	7.6
2007	0.05	0.01	0.01	1	6.9
2008	0.05	0.01	0.01	2	6.7
2009	0.05	0.01	0.01	1	6.8
2010	0.05	0.06	0.06	9	7.2
2011	0.05	0.08	0.08	10	7.8
2012	0.05	0.05	0.05	6	8.4
2013	0.05	0.11	0.11	12	8.7
2014	0.05	0.11	0.11	13	9.0
2015	0.05	0.21	0.21	23	9.1
2016	0.05	0.16	0.16	20	8.2
2017	0.05	0.17	0.17	25	6.9
2018	0.05	0.26	0.25	37	6.7
2019	0.05	0.39	0.37	52	7.1

**Table 32.** Input (with log-scale standard errors, SE) and expected (Exp) landings for the Recreational Private West fleet in numbers (N, 1,000s of fish) and weight (B, million pounds whole weight) for Gulf of Mexico Red Snapper. The mean body weight (MW, whole pounds per fish) was determined by dividing the expected landings in weights by the expected landings in numbers.

Year	Input N SE	Input N	Exp N	Exp B	MW
1950	0.15	138	138	0.83	6.0
1951	0.15	138	138	0.84	6.1
1952	0.15	138	138	0.85	6.2
1953	0.15	138	138	0.86	6.2
1954	0.15	138	138	0.86	6.2
1955	0.15	138	138	0.87	6.3
1956	0.15	153	153	0.96	6.3
1957	0.15	167	168	1.06	6.3
1958	0.15	182	182	1.17	6.4
1959	0.15	197	197	1.29	6.5
1960	0.15	212	212	1.39	6.5
1961	0.15	219	219	1.41	6.4
1962	0.15	226	226	1.43	6.3
1963	0.15	233	234	1.46	6.2
1964	0.15	240	241	1.49	6.2
1965	0.15	667	675	4.13	6.1
1966	0.15	687	696	4.13	5.9
1967	0.15	707	718	4.16	5.8
1968	0.15	728	740	4.22	5.7
1969	0.15	748	762	4.26	5.6
1970	0.15	769	784	4.25	5.4
1971	0.15	840	860	4.45	5.2
1972	0.15	911	937	4.69	5.0
1973	0.15	983	1,015	4.91	4.8
1974	0.15	1,054	1,093	4.99	4.6



**Table 32 Continued.** Input (with log-scale standard errors, SE) and expected (Exp) landings for the Recreational Private West fleet in numbers (N, 1,000s of fish) and weight (B, million pounds whole weight) for Gulf of Mexico Red Snapper. The mean body weight (MW, whole pounds per fish) was determined by dividing the expected landings in weights by the expected landings in numbers.

Year	Input N SE	Input N	Exp N	Exp B	MW
1975	0.15	1,834	1,966	8.34	4.2
1976	0.15	1,841	1,979	7.67	3.9
1977	0.15	1,848	1,993	7.09	3.6
1978	0.15	1,856	2,008	6.70	3.3
1979	0.15	1,863	2,029	6.64	3.3
1980	0.15	1,871	2,040	6.40	3.1
1981	0.15	3,075	3,065	7.97	2.6
1982	0.15	1,863	1,544	3.36	2.2
1983	0.15	3,554	3,123	6.37	2.0
1984	0.15	790	822	1.52	1.9
1985	0.15	1,273	1,464	2.55	1.7
1986	0.15	1,731	1,737	3.11	1.8
1987	0.15	521	547	0.90	1.6
1988	0.15	806	989	1.76	1.8
1989	0.15	531	625	1.15	1.8
1990	0.15	396	379	0.80	2.1
1991	0.15	471	449	1.00	2.2
1992	0.15	625	542	1.31	2.4
1993	0.15	1,043	777	2.20	2.8
1994	0.15	1,205	879	2.52	2.9
1995	0.22	1,528	911	2.78	3.1
1996	0.18	1,067	707	2.16	3.0
1997	0.17	1,048	826	2.62	3.2
1998	0.25	1,012	847	2.81	3.3
1999	0.18	657	640	2.45	3.8

**Table 32 Continued.** Input (with log-scale standard errors, SE) and expected (Exp) landings for the Recreational Private West fleet in numbers (N, 1,000s of fish) and weight (B, million pounds whole weight) for Gulf of Mexico Red Snapper. The mean body weight (MW, whole pounds per fish) was determined by dividing the expected landings in weights by the expected landings in numbers.

Year	Input N SE	Input N	Exp N	Exp B	MW
2000	0.19	656	599	2.11	3.5
2001	0.19	468	447	1.57	3.5
2002	0.18	428	443	1.60	3.6
2003	0.18	382	452	1.68	3.7
2004	0.19	360	437	1.57	3.6
2005	0.18	558	701	2.36	3.4
2006	0.17	697	922	2.93	3.2
2007	0.16	538	558	2.43	4.3
2008	0.22	418	447	1.97	4.4
2009	0.18	419	445	2.10	4.7
2010	0.22	256	262	1.30	5.0
2011	0.20	380	390	2.04	5.2
2012	0.18	449	406	2.21	5.4
2013	0.18	579	671	3.71	5.5
2014	0.18	587	616	3.47	5.6
2015	0.15	714	713	4.11	5.8
2016	0.17	456	330	1.93	5.8
2017	0.16	564	550	3.27	5.9
2018	0.15	634	623	3.76	6.0
2019	0.17	942	1,057	6.40	6.1

**Table 33.** Input (with log-scale standard errors, SE) and expected (Exp) landings for the Recreational Private Central fleet in numbers (N, 1,000s of fish) and weight (B, million pounds whole weight) for Gulf of Mexico Red Snapper. The mean body weight (MW, whole pounds per fish) was determined by dividing the expected landings in weights by the expected landings in numbers.

Year	Input N SE	Input N	Exp N	Exp B	MW
1950	0.15	110	110	0.53	4.8
1951	0.15	110	110	0.53	4.8
1952	0.15	110	110	0.54	4.9
1953	0.15	110	110	0.54	4.9
1954	0.15	110	110	0.54	4.9
1955	0.15	110	110	0.54	4.9
1956	0.15	122	122	0.60	4.9
1957	0.15	134	134	0.66	4.9
1958	0.15	146	146	0.72	4.9
1959	0.15	157	158	0.77	4.9
1960	0.15	169	169	0.81	4.8
1961	0.15	175	175	0.82	4.7
1962	0.15	181	181	0.83	4.6
1963	0.15	186	187	0.83	4.5
1964	0.15	192	192	0.83	4.3
1965	0.15	305	306	1.28	4.2
1966	0.15	314	316	1.28	4.1
1967	0.15	324	325	1.28	3.9
1968	0.15	333	335	1.27	3.8
1969	0.15	342	344	1.27	3.7
1970	0.15	352	354	1.26	3.6
1971	0.15	384	388	1.34	3.5
1972	0.15	417	421	1.41	3.3
1973	0.15	450	455	1.47	3.2
1974	0.15	482	489	1.50	3.1

**Table 33 Continued.** Input (with log-scale standard errors, SE) and expected (Exp) landings for the Recreational Private Central fleet in numbers (N, 1,000s of fish) and weight (B, million pounds whole weight) for Gulf of Mexico Red Snapper. The mean body weight (MW, whole pounds per fish) was determined by dividing the expected landings in weights by the expected landings in numbers.

Year	Input N SE	Input N	Exp N	Exp B	MW
1975	0.15	696	712	2.07	2.9
1976	0.15	699	717	2.24	3.1
1977	0.15	702	720	2.06	2.9
1978	0.15	705	721	1.78	2.5
1979	0.15	707	716	1.42	2.0
1980	0.15	710	711	1.21	1.7
1981	0.15	1,815	1,873	3.87	2.1
1982	0.15	212	199	0.43	2.1
1983	0.15	752	674	1.15	1.7
1984	0.15	273	277	0.42	1.5
1985	0.15	612	531	0.78	1.5
1986	0.15	262	258	0.42	1.6
1987	0.15	492	518	1.13	2.2
1988	0.15	366	305	0.45	1.5
1989	0.15	588	622	1.01	1.6
1990	0.15	349	332	1.00	3.0
1991	0.15	807	656	1.78	2.7
1992	0.15	1,422	690	1.86	2.7
1993	0.15	1,435	1,004	2.87	2.9
1994	0.15	1,002	588	1.79	3.0
1995	0.26	647	202	0.72	3.6
1996	0.20	507	443	1.49	3.4
1997	0.20	818	650	1.95	3.0
1998	0.21	563	436	1.31	3.0
1999	0.23	1,301	827	3.33	4.0

**Table 33 Continued.** Input (with log-scale standard errors, SE) and expected (Exp) landings for the Recreational Private Central fleet in numbers (N, 1,000s of fish) and weight (B, million pounds whole weight) for Gulf of Mexico Red Snapper. The mean body weight (MW, whole pounds per fish) was determined by dividing the expected landings in weights by the expected landings in numbers.

Year	Input N SE	Input N	Exp N	Exp B	MW
2000	0.21	865	727	2.88	4.0
2001	0.22	1,393	733	2.92	4.0
2002	0.20	1,872	1,374	5.33	3.9
2003	0.19	1,288	1,040	3.96	3.8
2004	0.27	1,633	1,377	5.14	3.7
2005	0.24	900	1,030	3.78	3.7
2006	0.20	985	827	2.91	3.5
2007	0.22	1,526	2,250	8.54	3.8
2008	0.17	898	874	3.47	4.0
2009	0.21	1,079	1,599	7.02	4.4
2010	0.30	1,033	1,443	7.11	4.9
2011	0.20	1,243	1,670	9.00	5.4
2012	0.21	1,161	1,175	6.75	5.7
2013	0.30	2,092	1,559	9.35	6.0
2014	0.21	893	627	3.74	6.0
2015	0.23	1,023	872	5.16	5.9
2016	0.14	1,281	1,076	6.20	5.8
2017	0.19	2,568	2,349	12.66	5.4
2018	0.24	1,751	1,221	6.28	5.1
2019	0.20	1,947	1,758	9.25	5.3

**Table 34.** Input (with log-scale standard errors, SE) and expected (Exp) landings for the Recreational Private East fleet in numbers (N, 1,000s of fish) and weight (B, million pounds whole weight) for Gulf of Mexico Red Snapper. The mean body weight (MW, whole pounds per fish) was determined by dividing the expected landings in weights by the expected landings in numbers.

Year	Input N SE	Input N	Exp N	Exp B	MW
1950	0.15	25	25	0.12	4.7
1951	0.15	25	25	0.12	4.8
1952	0.15	25	25	0.12	4.9
1953	0.15	25	25	0.12	4.9
1954	0.15	25	25	0.12	4.9
1955	0.15	25	25	0.12	5.0
1956	0.15	27	27	0.14	5.0
1957	0.15	30	30	0.15	5.0
1958	0.15	33	33	0.16	5.0
1959	0.15	35	35	0.17	4.9
1960	0.15	38	38	0.18	4.7
1961	0.15	39	39	0.17	4.5
1962	0.15	41	41	0.17	4.2
1963	0.15	42	42	0.17	4.0
1964	0.15	43	43	0.16	3.8
1965	0.15	92	92	0.33	3.6
1966	0.15	95	95	0.31	3.3
1967	0.15	98	97	0.30	3.1
1968	0.15	100	100	0.30	3.0
1969	0.15	103	103	0.30	2.9
1970	0.15	106	106	0.30	2.8
1971	0.15	116	115	0.32	2.7
1972	0.15	126	125	0.33	2.7
1973	0.15	136	135	0.35	2.6
1974	0.15	146	145	0.36	2.5

**Table 34 Continued.** Input (with log-scale standard errors, SE) and expected (Exp) landings for the Recreational Private East fleet in numbers (N, 1,000s of fish) and weight (B, million pounds whole weight) for Gulf of Mexico Red Snapper. The mean body weight (MW, whole pounds per fish) was determined by dividing the expected landings in weights by the expected landings in numbers.

Year	Input N SE	Input N	Exp N	Exp B	MW
1975	0.15	236	234	0.52	2.2
1976	0.15	237	236	0.35	1.5
1977	0.15	238	237	0.39	1.6
1978	0.15	239	238	0.44	1.8
1979	0.15	240	239	0.45	1.9
1980	0.15	240	240	0.39	1.6
1981	0.15	568	568	0.90	1.6
1982	0.15	12	12	0.03	2.4
1983	0.15	581	583	1.96	3.4
1984	0.15	21	22	0.09	4.0
1985	0.15	157	159	0.46	2.9
1986	0.15	181	183	0.53	2.9
1987	0.15	106	106	0.22	2.1
1988	0.15	49	50	0.12	2.4
1989	0.15	142	144	0.23	1.6
1990	0.15	42	42	0.20	4.7
1991	0.15	17	18	0.07	4.1
1992	0.15	4	4	0.01	4.2
1993	0.15	0	0	0.00	3.8
1994	0.15	0	0	0.00	3.4
1995	0.83	3	4	0.02	4.4
1996	0.59	37	47	0.20	4.3
1997	0.59	0	0	0.00	4.1
1998	0.59	0	0	0.00	3.9
1999	0.49	12	12	0.06	5.4

**Table 34 Continued.** Input (with log-scale standard errors, SE) and expected (Exp) landings for the Recreational Private East fleet in numbers (N, 1,000s of fish) and weight (B, million pounds whole weight) for Gulf of Mexico Red Snapper. The mean body weight (MW, whole pounds per fish) was determined by dividing the expected landings in weights by the expected landings in numbers.

Year	Input N SE	Input N	Exp N	Exp B	MW
2000	0.83	2	4	0.02	4.9
2001	0.83	0	0	0.00	5.2
2002	0.65	8	8	0.04	5.2
2003	0.70	3	3	0.01	5.3
2004	0.78	7	9	0.05	5.6
2005	0.55	81	114	0.66	5.8
2006	0.70	19	18	0.10	5.6
2007	0.72	41	45	0.25	5.5
2008	0.83	6	5	0.03	5.4
2009	0.55	19	22	0.12	5.5
2010	0.65	3	5	0.03	6.0
2011	0.60	16	16	0.11	6.8
2012	0.65	15	14	0.10	7.2
2013	0.70	4	4	0.03	7.4
2014	0.67	5	5	0.04	7.6
2015	0.83	2	2	0.01	7.8
2016	0.57	27	27	0.17	6.3
2017	0.40	77	75	0.39	5.3
2018	0.44	101	111	0.60	5.4
2019	0.50	106	103	0.62	6.0



**Table 35.** Input (with log-scale standard errors, SE) and expected (Exp) landings for the Recreational Charter West fleet in numbers (N, 1,000s of fish) and weight (B, million pounds whole weight) for Gulf of Mexico Red Snapper. The mean body weight (MW, whole pounds per fish) was determined by dividing the expected landings in weights by the expected landings in numbers.

Year	Input N SE	Input N	Exp N	Exp B	MW
1950	0.15	386	387	2.46	6.3
1951	0.15	386	387	2.50	6.4
1952	0.15	386	387	2.53	6.5
1953	0.15	386	387	2.55	6.6
1954	0.15	386	387	2.56	6.6
1955	0.15	386	387	2.58	6.7
1956	0.15	427	429	2.85	6.7
1957	0.15	469	471	3.15	6.7
1958	0.15	510	513	3.48	6.8
1959	0.15	551	555	3.84	6.9
1960	0.15	592	597	4.15	7.0
1961	0.15	612	617	4.23	6.9
1962	0.15	632	638	4.29	6.7
1963	0.15	652	658	4.38	6.7
1964	0.15	671	679	4.50	6.6
1965	0.15	428	431	2.82	6.5
1966	0.15	441	445	2.83	6.4
1967	0.15	454	458	2.85	6.2
1968	0.15	467	472	2.89	6.1
1969	0.15	480	486	2.92	6.0
1970	0.15	493	500	2.92	5.9
1971	0.15	539	547	3.06	5.6
1972	0.15	585	595	3.23	5.4
1973	0.15	630	644	3.38	5.2
1974	0.15	676	693	3.44	5.0

**Table 35 Continued.** Input (with log-scale standard errors, SE) and expected (Exp) landings for the Recreational Charter West fleet in numbers (N, 1,000s of fish) and weight (B, million pounds whole weight) for Gulf of Mexico Red Snapper. The mean body weight (MW, whole pounds per fish) was determined by dividing the expected landings in weights by the expected landings in numbers.

Year	Input N SE	Input N	Exp N	Exp B	MW
1975	0.15	277	280	1.30	4.6
1976	0.15	278	281	1.19	4.2
1977	0.15	279	282	1.10	3.9
1978	0.15	280	283	1.04	3.7
1979	0.15	281	285	1.02	3.6
1980	0.15	282	286	0.99	3.4
1981	0.15	226	228	0.66	2.9
1982	0.15	275	296	0.71	2.4
1983	0.15	422	403	0.91	2.2
1984	0.15	378	304	0.62	2.0
1985	0.15	613	505	0.97	1.9
1986	0.15	77	94	0.18	2.0
1987	0.15	64	69	0.12	1.8
1988	0.15	15	17	0.03	1.9
1989	0.15	63	67	0.13	2.0
1990	0.15	28	29	0.07	2.3
1991	0.15	115	117	0.28	2.4
1992	0.15	123	121	0.31	2.6
1993	0.15	82	83	0.25	3.0
1994	0.15	57	67	0.20	3.1
1995	0.47	74	72	0.25	3.4
1996	0.46	57	73	0.25	3.4
1997	0.29	68	71	0.25	3.5
1998	0.33	106	83	0.31	3.7
1999	0.41	57	19	0.08	4.4

**Table 35 Continued.** Input (with log-scale standard errors, SE) and expected (Exp) landings for the Recreational Charter West fleet in numbers (N, 1,000s of fish) and weight (B, million pounds whole weight) for Gulf of Mexico Red Snapper. The mean body weight (MW, whole pounds per fish) was determined by dividing the expected landings in weights by the expected landings in numbers.

Year	Input N SE	Input N	Exp N	Exp B	MW
2000	0.25	20	13	0.05	4.0
2001	0.30	19	18	0.07	3.9
2002	0.24	54	48	0.19	4.0
2003	0.26	56	55	0.22	4.1
2004	0.25	82	105	0.42	4.1
2005	0.27	74	96	0.37	3.8
2006	0.20	95	115	0.41	3.6
2007	0.20	64	97	0.57	5.9
2008	0.37	25	56	0.33	5.8
2009	0.38	29	36	0.21	6.1
2010	0.41	8	52	0.33	6.4
2011	0.42	10	15	0.10	6.7
2012	0.41	28	24	0.17	6.9
2013	0.44	20	38	0.27	7.1
2014	0.20	11	14	0.10	7.3
2015	0.12	29	32	0.23	7.4
2016	0.10	34	26	0.20	7.5
2017	0.11	37	23	0.18	7.7
2018	0.15	26	14	0.11	7.8
2019	0.15	29	59	0.46	7.8

**Table 36.** Input (with log-scale standard errors, SE) and expected (Exp) landings for the Recreational Charter Central fleet in numbers (N, 1,000s of fish) and weight (B, million pounds whole weight) for Gulf of Mexico Red Snapper. The mean body weight (MW, whole pounds per fish) was determined by dividing the expected landings in weights by the expected landings in numbers.

Year	Input N SE	Input N	Exp N	Exp B	MW
1950	0.15	221	221	1.57	7.1
1951	0.15	221	221	1.57	7.1
1952	0.15	221	221	1.58	7.2
1953	0.15	221	221	1.58	7.2
1954	0.15	221	221	1.59	7.2
1955	0.15	221	221	1.59	7.2
1956	0.15	244	245	1.77	7.2
1957	0.15	268	268	1.95	7.3
1958	0.15	291	292	2.12	7.3
1959	0.15	315	316	2.29	7.3
1960	0.15	338	340	2.45	7.2
1961	0.15	350	351	2.50	7.1
1962	0.15	361	363	2.54	7.0
1963	0.15	372	374	2.58	6.9
1964	0.15	384	386	2.61	6.8
1965	0.15	321	323	2.14	6.6
1966	0.15	331	333	2.15	6.5
1967	0.15	341	343	2.17	6.3
1968	0.15	351	353	2.18	6.2
1969	0.15	360	363	2.19	6.0
1970	0.15	370	374	2.20	5.9
1971	0.15	405	409	2.36	5.8
1972	0.15	439	445	2.51	5.6
1973	0.15	473	481	2.65	5.5
1974	0.15	508	517	2.77	5.4

**Table 36 Continued.** Input (with log-scale standard errors, SE) and expected (Exp) landings for the Recreational Charter Central fleet in numbers (N, 1,000s of fish) and weight (B, million pounds whole weight) for Gulf of Mexico Red Snapper. The mean body weight (MW, whole pounds per fish) was determined by dividing the expected landings in weights by the expected landings in numbers.

Year	Input N SE	Input N	Exp N	Exp B	MW
1975	0.15	417	424	2.19	5.2
1976	0.15	419	427	2.26	5.3
1977	0.15	421	430	2.19	5.1
1978	0.15	422	431	2.02	4.7
1979	0.15	424	431	1.73	4.0
1980	0.15	426	430	1.50	3.5
1981	0.15	72	63	0.24	3.8
1982	0.15	409	395	1.56	3.9
1983	0.15	760	787	2.73	3.5
1984	0.15	211	200	0.63	3.1
1985	0.15	239	226	0.67	3.0
1986	0.15	507	485	1.51	3.1
1987	0.15	457	480	1.77	3.7
1988	0.15	358	384	1.18	3.1
1989	0.15	204	203	0.65	3.2
1990	0.15	144	132	0.42	3.2
1991	0.15	190	199	0.57	2.9
1992	0.15	352	384	1.10	2.9
1993	0.15	836	771	2.35	3.0
1994	0.15	373	366	1.19	3.2
1995	0.27	297	284	1.18	4.1
1996	0.30	423	448	1.72	3.8
1997	0.15	544	629	2.16	3.4
1998	0.10	871	915	3.09	3.4
1999	0.10	632	683	2.66	3.9

**Table 36 Continued.** Input (with log-scale standard errors, SE) and expected (Exp) landings for the Recreational Charter Central fleet in numbers (N, 1,000s of fish) and weight (B, million pounds whole weight) for Gulf of Mexico Red Snapper. The mean body weight (MW, whole pounds per fish) was determined by dividing the expected landings in weights by the expected landings in numbers.

Year	Input N SE	Input N	Exp N	Exp B	MW
2000	0.08	376	483	1.94	4.0
2001	0.09	396	530	2.13	4.0
2002	0.09	556	633	2.48	3.9
2003	0.09	526	635	2.43	3.8
2004	0.09	532	658	2.46	3.7
2005	0.10	386	537	1.96	3.7
2006	0.11	388	607	2.11	3.5
2007	0.11	476	582	2.24	3.8
2008	0.12	265	229	0.93	4.1
2009	0.16	205	298	1.36	4.6
2010	0.17	69	87	0.45	5.2
2011	0.19	153	170	0.97	5.7
2012	0.17	150	121	0.74	6.1
2013	0.34	166	139	0.88	6.4
2014	0.27	35	21	0.14	6.4
2015	0.23	205	108	0.68	6.3
2016	0.22	218	186	1.14	6.1
2017	0.26	239	279	1.60	5.7
2018	0.23	229	196	1.07	5.5
2019	0.27	282	255	1.42	5.6

**Table 37.** Input (with log-scale standard errors, SE) and expected (Exp) landings for the Recreational Charter East fleet in numbers (N, 1,000s of fish) and weight (B, million pounds whole weight) for Gulf of Mexico Red Snapper. The mean body weight (MW, whole pounds per fish) was determined by dividing the expected landings in weights by the expected landings in numbers.

Year	Input N SE	Input N	Exp N	Exp B	MW
1950	0.15	62	61	0.43	7.1
1951	0.15	62	61	0.44	7.2
1952	0.15	62	61	0.44	7.2
1953	0.15	62	61	0.45	7.3
1954	0.15	62	61	0.45	7.4
1955	0.15	62	61	0.45	7.4
1956	0.15	69	67	0.50	7.5
1957	0.15	75	74	0.55	7.5
1958	0.15	82	80	0.60	7.5
1959	0.15	89	86	0.64	7.4
1960	0.15	95	92	0.67	7.3
1961	0.15	98	95	0.67	7.1
1962	0.15	102	98	0.67	6.8
1963	0.15	105	100	0.66	6.6
1964	0.15	108	103	0.65	6.3
1965	0.15	63	61	0.37	6.0
1966	0.15	65	63	0.36	5.8
1967	0.15	67	65	0.36	5.5
1968	0.15	69	66	0.36	5.4
1969	0.15	70	68	0.36	5.2
1970	0.15	72	70	0.36	5.1
1971	0.15	79	76	0.38	5.0
1972	0.15	86	82	0.40	4.9
1973	0.15	93	88	0.43	4.9
1974	0.15	99	94	0.44	4.7

**Table 37 Continued.** Input (with log-scale standard errors, SE) and expected (Exp) landings for the Recreational Charter East fleet in numbers (N, 1,000s of fish) and weight (B, million pounds whole weight) for Gulf of Mexico Red Snapper. The mean body weight (MW, whole pounds per fish) was determined by dividing the expected landings in weights by the expected landings in numbers.

Year	Input N SE	Input N	Exp N	Exp B	MW
1975	0.15	24	24	0.11	4.4
1976	0.15	25	24	0.08	3.3
1977	0.15	25	24	0.08	3.3
1978	0.15	25	25	0.09	3.5
1979	0.15	25	25	0.09	3.7
1980	0.15	25	25	0.09	3.5
1981	0.15	22	22	0.07	3.4
1982	0.15	4	4	0.02	4.1
1983	0.15	37	37	0.18	4.9
1984	0.15	32	33	0.19	5.8
1985	0.15	11	12	0.06	5.6
1986	0.15	62	76	0.43	5.6
1987	0.15	3	4	0.02	4.8
1988	0.15	6	6	0.03	4.8
1989	0.15	11	12	0.04	3.8
1990	0.15	0	0	0.00	4.9
1991	0.15	0	0	0.00	4.3
1992	0.15	3	3	0.01	4.3
1993	0.15	0	0	0.00	4.1
1994	0.15	0	0	0.00	3.7
1995	0.83	0	0	0.00	4.7
1996	0.83	0	0	0.00	4.6
1997	0.67	2	2	0.01	4.4
1998	0.62	8	17	0.07	4.1
1999	0.44	1	1	0.01	5.4



**Table 37 Continued.** Input (with log-scale standard errors, SE) and expected (Exp) landings for the Recreational Charter East fleet in numbers (N, 1,000s of fish) and weight (B, million pounds whole weight) for Gulf of Mexico Red Snapper. The mean body weight (MW, whole pounds per fish) was determined by dividing the expected landings in weights by the expected landings in numbers.

Year	Input N SE	Input N	Exp N	Exp B	MW
2000	0.67	0	1	0.00	4.9
2001	0.50	2	1	0.00	5.2
2002	0.50	1	1	0.00	5.2
2003	0.38	2	2	0.01	5.4
2004	0.45	0	0	0.00	5.7
2005	0.43	2	2	0.01	5.8
2006	0.74	11	48	0.27	5.6
2007	0.66	1	0	0.00	5.7
2008	0.56	3	3	0.02	5.6
2009	0.57	2	7	0.04	5.7
2010	0.68	4	3	0.02	6.2
2011	0.68	0	0	0.00	7.0
2012	0.72	3	1	0.01	7.5
2013	0.68	0	8	0.06	7.7
2014	0.60	4	2	0.01	7.9
2015	0.62	8	8	0.06	8.1
2016	0.51	8	6	0.04	6.6
2017	0.48	19	18	0.10	5.5
2018	0.57	23	22	0.13	5.6
2019	0.30	18	15	0.10	6.2

**Table 38.** Input (with log-scale standard errors, SE) and expected (Exp) landings for the Recreational Headboat West fleet in numbers (N, 1,000s of fish) and weight (B, million pounds whole weight) for Gulf of Mexico Red Snapper. The mean body weight (MW, whole pounds per fish) was determined by dividing the expected landings in weights by the expected landings in numbers.

Year	Input N SE	Input N	Exp N	Exp B	MW
1950	0.15	317	318	1.59	5.0
1951	0.15	317	318	1.62	5.1
1952	0.15	317	318	1.64	5.2
1953	0.15	317	318	1.65	5.2
1954	0.15	317	318	1.66	5.2
1955	0.15	317	318	1.67	5.2
1956	0.15	351	352	1.84	5.2
1957	0.15	385	386	2.03	5.3
1958	0.15	419	420	2.25	5.4
1959	0.15	453	455	2.48	5.5
1960	0.15	487	489	2.68	5.5
1961	0.15	503	506	2.71	5.4
1962	0.15	519	523	2.73	5.2
1963	0.15	535	539	2.78	5.1
1964	0.15	552	556	2.85	5.1
1965	0.15	410	412	2.08	5.0
1966	0.15	422	425	2.07	4.9
1967	0.15	435	438	2.08	4.7
1968	0.15	447	451	2.10	4.7
1969	0.15	460	464	2.12	4.6
1970	0.15	472	477	2.10	4.4
1971	0.15	516	523	2.18	4.2
1972	0.15	560	568	2.29	4.0
1973	0.15	604	614	2.39	3.9
1974	0.15	648	660	2.42	3.7

**Table 38 Continued.** Input (with log-scale standard errors, SE) and expected (Exp) landings for the Recreational Headboat West fleet in numbers (N, 1,000s of fish) and weight (B, million pounds whole weight) for Gulf of Mexico Red Snapper. The mean body weight (MW, whole pounds per fish) was determined by dividing the expected landings in weights by the expected landings in numbers.

Year	Input N SE	Input N	Exp N	Exp B	MW
1975	0.15	424	430	1.46	3.4
1976	0.15	426	432	1.33	3.1
1977	0.15	428	434	1.23	2.8
1978	0.15	429	436	1.16	2.7
1979	0.15	431	438	1.15	2.6
1980	0.15	433	440	1.11	2.5
1981	0.15	355	358	0.75	2.1
1982	0.15	359	382	0.68	1.8
1983	0.15	371	300	0.51	1.7
1984	0.15	368	398	0.62	1.6
1985	0.15	388	418	0.62	1.5
1986	0.15	316	306	0.47	1.5
1987	0.15	319	312	0.44	1.4
1988	0.15	423	434	0.66	1.5
1989	0.15	372	377	0.59	1.6
1990	0.15	187	172	0.34	2.0
1991	0.15	265	189	0.40	2.1
1992	0.15	413	295	0.66	2.2
1993	0.15	459	304	0.78	2.6
1994	0.15	498	366	0.96	2.6
1995	0.18	355	280	0.91	3.3
1996	0.31	349	243	0.78	3.2
1997	0.24	347	225	0.76	3.4
1998	0.14	245	206	0.73	3.5
1999	0.22	99	51	0.23	4.5

**Table 38 Continued.** Input (with log-scale standard errors, SE) and expected (Exp) landings for the Recreational Headboat West fleet in numbers (N, 1,000s of fish) and weight (B, million pounds whole weight) for Gulf of Mexico Red Snapper. The mean body weight (MW, whole pounds per fish) was determined by dividing the expected landings in weights by the expected landings in numbers.

Year	Input N SE	Input N	Exp N	Exp B	MW
2000	0.19	111	69	0.26	3.7
2001	0.21	116	97	0.36	3.7
2002	0.09	138	127	0.48	3.8
2003	0.39	158	96	0.37	3.9
2004	0.12	110	109	0.42	3.8
2005	0.21	100	102	0.37	3.6
2006	0.20	121	112	0.38	3.4
2007	0.53	110	118	0.60	5.1
2008	0.24	58	71	0.36	5.1
2009	0.09	76	77	0.41	5.3
2010	0.05	52	52	0.28	5.5
2011	0.05	51	51	0.29	5.7
2012	0.09	54	55	0.32	5.8
2013	0.05	44	44	0.26	5.9
2014	0.05	36	36	0.21	6.0
2015	0.05	63	62	0.38	6.1
2016	0.05	61	60	0.37	6.2
2017	0.07	60	60	0.37	6.2
2018	0.05	63	62	0.39	6.3
2019	0.06	67	67	0.42	6.3

**Table 39.** Input (with log-scale standard errors, SE) and expected (Exp) landings for the Recreational Headboat Central fleet in numbers (N, 1,000s of fish) and weight (B, million pounds whole weight) for Gulf of Mexico Red Snapper. The mean body weight (MW, whole pounds per fish) was determined by dividing the expected landings in weights by the expected landings in numbers.

Year	Input N SE	Input N	Exp N	Exp B	MW
1950	0.15	124	124	0.77	6.2
1951	0.15	124	124	0.77	6.2
1952	0.15	124	124	0.78	6.2
1953	0.15	124	124	0.78	6.3
1954	0.15	124	124	0.78	6.3
1955	0.15	124	124	0.78	6.3
1956	0.15	137	138	0.87	6.3
1957	0.15	151	151	0.95	6.3
1958	0.15	164	164	1.04	6.3
1959	0.15	177	177	1.12	6.3
1960	0.15	190	191	1.20	6.3
1961	0.15	197	197	1.22	6.2
1962	0.15	203	204	1.23	6.0
1963	0.15	209	210	1.25	5.9
1964	0.15	216	216	1.25	5.8
1965	0.15	185	186	1.05	5.6
1966	0.15	191	191	1.05	5.5
1967	0.15	197	197	1.05	5.3
1968	0.15	202	203	1.05	5.2
1969	0.15	208	209	1.05	5.0
1970	0.15	214	215	1.05	4.9
1971	0.15	233	235	1.12	4.8
1972	0.15	253	255	1.18	4.6
1973	0.15	273	275	1.24	4.5
1974	0.15	293	296	1.29	4.4

**Table 39 Continued.** Input (with log-scale standard errors, SE) and expected (Exp) landings for the Recreational Headboat Central fleet in numbers (N, 1,000s of fish) and weight (B, million pounds whole weight) for Gulf of Mexico Red Snapper. The mean body weight (MW, whole pounds per fish) was determined by dividing the expected landings in weights by the expected landings in numbers.

Year	Input N SE	Input N	Exp N	Exp B	MW
1975	0.15	250	253	1.05	4.2
1976	0.15	251	254	1.09	4.3
1977	0.15	252	255	1.05	4.1
1978	0.15	253	256	0.95	3.7
1979	0.15	254	256	0.80	3.1
1980	0.15	255	256	0.69	2.7
1981	0.15	44	40	0.12	3.0
1982	0.15	247	240	0.75	3.1
1983	0.15	475	483	1.29	2.7
1984	0.15	132	127	0.31	2.4
1985	0.15	149	143	0.33	2.3
1986	0.15	15	14	0.03	2.4
1987	0.15	9	9	0.03	2.9
1988	0.15	13	13	0.03	2.4
1989	0.15	10	10	0.02	2.4
1990	0.15	15	13	0.03	2.4
1991	0.15	15	15	0.03	2.2
1992	0.15	34	31	0.07	2.2
1993	0.15	37	32	0.08	2.4
1994	0.15	29	26	0.07	2.5
1995	0.14	23	23	0.06	2.7
1996	0.09	28	28	0.07	2.6
1997	0.13	48	51	0.12	2.3
1998	0.14	76	57	0.14	2.4
1999	0.17	65	41	0.12	2.8

**Table 39 Continued.** Input (with log-scale standard errors, SE) and expected (Exp) landings for the Recreational Headboat Central fleet in numbers (N, 1,000s of fish) and weight (B, million pounds whole weight) for Gulf of Mexico Red Snapper. The mean body weight (MW, whole pounds per fish) was determined by dividing the expected landings in weights by the expected landings in numbers.

Year	Input N SE	Input N	Exp N	Exp B	MW
2000	0.11	56	55	0.17	3.1
2001	0.13	50	48	0.15	3.0
2002	0.16	75	54	0.16	3.0
2003	0.25	71	52	0.15	3.0
2004	0.24	62	46	0.13	2.9
2005	0.25	42	39	0.11	2.9
2006	0.37	47	50	0.14	2.8
2007	0.41	63	25	0.08	3.2
2008	0.09	61	57	0.19	3.3
2009	0.05	78	76	0.28	3.7
2010	0.06	34	35	0.14	4.2
2011	0.05	66	66	0.30	4.6
2012	0.08	52	52	0.25	4.9
2013	0.05	41	42	0.21	5.0
2014	0.05	41	40	0.20	4.9
2015	0.05	42	41	0.20	4.9
2016	0.05	36	36	0.17	4.7
2017	0.05	50	51	0.22	4.4
2018	0.05	57	57	0.24	4.2
2019	0.05	41	42	0.18	4.4

**Table 40.** Input (with log-scale standard errors, SE) and expected (Exp) landings for the Recreational Headboat East fleet in numbers (N, 1,000s of fish) and weight (B, million pounds whole weight) for Gulf of Mexico Red Snapper. The mean body weight (MW, whole pounds per fish) was determined by dividing the expected landings in weights by the expected landings in numbers.

Year	Input N SE	Input N	Exp N	Exp B	MW
1955	0.15	3	3	0.02	6.7
1956	0.15	3	3	0.02	6.7
1957	0.15	4	4	0.02	6.8
1958	0.15	4	4	0.03	6.8
1959	0.15	4	4	0.03	6.7
1960	0.15	4	4	0.03	6.5
1961	0.15	5	5	0.03	6.3
1962	0.15	5	5	0.03	6.0
1963	0.15	5	5	0.03	5.8
1964	0.15	5	5	0.03	5.5
1965	0.15	5	5	0.03	5.2
1966	0.15	5	5	0.03	4.9
1967	0.15	6	6	0.03	4.7
1968	0.15	6	6	0.03	4.5
1969	0.15	6	6	0.03	4.4
1970	0.15	6	6	0.03	4.2
1971	0.15	7	7	0.03	4.1
1972	0.15	7	7	0.03	4.0
1973	0.15	8	8	0.03	3.9
1974	0.15	8	8	0.03	3.8
1975	0.15	9	9	0.03	3.5
1976	0.15	9	9	0.02	2.6
1977	0.15	9	9	0.02	2.6
1978	0.15	9	9	0.02	2.8
1979	0.15	9	9	0.03	2.9



**Table 40 Continued.** Input (with log-scale standard errors, SE) and expected (Exp) landings for the Recreational Headboat East fleet in numbers (N, 1,000s of fish) and weight (B, million pounds whole weight) for Gulf of Mexico Red Snapper. The mean body weight (MW, whole pounds per fish) was determined by dividing the expected landings in weights by the expected landings in numbers.

Year	Input N SE	Input N	Exp N	Exp B	MW
1980	0.15	9	9	0.02	2.7
1981	0.15	14	13	0.04	2.6
1982	0.15	3	3	0.01	3.2
1983	0.15	23	23	0.10	4.1
1984	0.15	19	20	0.10	5.0
1985	0.15	7	7	0.03	4.5
1986	0.15	1	2	0.01	4.4
1987	0.15	0	0	0.00	3.6
1988	0.15	1	1	0.00	3.7
1989	0.15	0	0	0.00	2.9
1990	0.15	0	0	0.00	3.8
1991	0.15	0	0	0.00	3.4
1992	0.15	0	0	0.00	3.5
1993	0.15	1	1	0.00	3.1
1994	0.15	0	0	0.00	2.8
1995	0.46	0	0	0.00	3.1
1996	0.41	0	0	0.00	3.1
1997	0.33	0	0	0.00	3.0
1998	0.54	0	0	0.00	2.8
1999	0.52	3	1	0.01	4.8
2000	0.56	1	1	0.00	3.7
2001	0.56	1	1	0.00	3.9
2002	0.46	0	0	0.00	3.8
2003	0.40	0	0	0.00	4.0
2004	0.32	1	1	0.01	4.2

**Table 40 Continued.** Input (with log-scale standard errors, SE) and expected (Exp) landings for the Recreational Headboat East fleet in numbers (N, 1,000s of fish) and weight (B, million pounds whole weight) for Gulf of Mexico Red Snapper. The mean body weight (MW, whole pounds per fish) was determined by dividing the expected landings in weights by the expected landings in numbers.

Year	Input N SE	Input N	Exp N	Exp B	MW
2005	0.25	5	4	0.02	4.3
2006	0.26	1	1	0.00	4.1
2007	0.25	1	1	0.00	4.5
2008	0.07	1	1	0.01	4.5
2009	0.05	3	3	0.01	4.7
2010	0.10	2	2	0.01	5.3
2011	0.06	3	3	0.02	6.1
2012	0.05	2	2	0.02	6.4
2013	0.05	3	3	0.02	6.5
2014	0.05	2	2	0.01	6.7
2015	0.05	3	3	0.02	6.6
2016	0.05	3	3	0.01	4.8
2017	0.05	8	8	0.04	4.3
2018	0.05	9	9	0.04	4.6
2019	0.05	9	9	0.05	5.4

**Table 41.** Gulf of Mexico Red Snapper Commercial Handline West discards in numbers. Discards refer to the total number of fish discarded before applying the discard mortality rate. In SEDAR 74, catches were modelled as total catch, by summing the landings with the dead discards.

Year	Input N SE	Input N	Exp N	Exp Dead N	Exp B	Exp Dead B	MW
1995	0.555	367.594	510.486	108.223	394.012	83.531	0.8
1996	0.555	639.217	604.817	128.221	518.615	109.944	0.9
1997	0.555	771.885	670.792	142.212	570.930	121.034	0.9
1998	0.555	867.539	678.205	143.775	564.184	119.623	0.8
1999	0.555	926.415	784.060	166.220	547.892	116.139	0.7
2000	0.555	843.145	938.820	199.030	739.253	156.726	0.8
2001	0.555	978.141	786.948	166.838	672.563	142.573	0.9
2002	0.555	962.175	694.682	147.272	577.170	122.356	0.8
2003	0.555	979.275	800.286	169.656	557.703	118.234	0.7
2004	0.555	1,022.330	990.647	210.017	667.405	141.493	0.7
2005	0.555	1,062.370	1,106.697	234.617	794.170	168.367	0.7
2006	0.555	1,178.930	1,522.700	322.820	1,177.752	249.695	0.8
2007	0.531	466.911	87.761	18.605	168.539	35.730	1.9
2008	0.452	131.928	55.889	11.848	117.663	24.943	2.1
2009	0.452	111.757	37.169	7.880	98.930	20.973	2.7
2010	0.452	92.165	51.294	10.874	128.335	27.207	2.5
2011	0.452	90.972	43.783	9.282	122.954	26.065	2.8
2012	0.452	103.466	49.877	10.574	139.810	29.641	2.8
2013	0.452	100.966	73.435	15.568	199.254	42.241	2.7
2014	0.432	27.537	70.533	14.953	205.779	43.629	2.9
2015	0.432	33.730	81.595	17.298	247.579	52.492	3.0
2016	0.432	31.153	87.566	18.564	252.716	53.572	2.9
2017	0.432	30.065	83.515	17.705	252.032	53.440	3.0
2018	0.432	25.897	76.632	16.246	243.611	51.632	3.2
2019	0.432	27.484	87.175	18.481	260.740	55.270	3.0

**Table 42.** Gulf of Mexico Red Snapper Commercial Handline Central discards in numbers. Discards refer to the total number of fish discarded before applying the discard mortality rate. In SEDAR 74, catches were modelled as total catch, by summing the landings with the dead discards.

Year	Input N SE	Input N	Exp N	Exp Dead N	Exp B	Exp Dead B	MW
1995	0.555	131.749	75.922	14.577	56.104	10.772	0.7
1996	0.555	154.510	128.670	24.705	76.002	14.592	0.6
1997	0.555	150.278	125.396	24.076	92.259	17.714	0.7
1998	0.555	166.751	169.051	32.458	147.390	28.301	0.9
1999	0.555	206.946	166.056	31.883	132.187	25.380	0.8
2000	0.555	259.730	244.389	46.922	176.363	33.863	0.7
2001	0.555	314.874	301.843	57.953	233.941	44.917	0.8
2002	0.555	366.366	395.516	75.939	313.532	60.197	0.8
2003	0.555	439.970	417.736	80.205	314.042	60.296	0.8
2004	0.555	396.933	429.204	82.407	333.054	63.945	0.8
2005	0.555	387.232	458.670	88.065	268.238	51.500	0.6
2006	0.555	426.410	485.194	93.157	358.332	68.800	0.7
2007	0.165	83.383	71.097	13.651	121.543	23.336	1.7
2008	0.241	49.728	52.817	10.141	101.289	19.447	1.9
2009	0.241	51.755	36.795	7.064	94.501	18.144	2.6
2010	0.241	58.449	50.978	9.788	138.838	26.656	2.7
2011	0.241	71.009	49.872	9.575	155.320	29.822	3.1
2012	0.241	77.763	53.583	10.288	181.134	34.778	3.4
2013	0.241	62.341	75.848	14.563	226.340	43.457	3.0
2014	0.289	66.197	63.648	12.220	194.229	37.293	3.1
2015	0.289	66.713	94.806	18.203	270.066	51.853	2.8
2016	0.289	72.065	97.872	18.792	250.985	48.189	2.6
2017	0.289	74.403	115.789	22.232	274.402	52.684	2.4
2018	0.289	62.429	92.450	17.751	241.512	46.370	2.6
2019	0.289	63.248	93.341	17.922	253.908	48.746	2.7

**Table 43.** Gulf of Mexico Red Snapper Commercial Handline East discards in numbers. Discards refer to the total number of fish discarded before applying the discard mortality rate. In SEDAR 74, catches were modelled as total catch, by summing the landings with the dead discards.

Year	Input N SE	Input N	Exp N	Exp Dead N	Exp B	Exp Dead B	MW
1995	0.555	7.949	4.861	1.201	2.336	0.577	0.5
1996	0.555	13.888	4.986	1.232	1.789	0.442	0.4
1997	0.555	10.113	6.221	1.536	2.685	0.663	0.4
1998	0.555	10.295	6.162	1.522	3.603	0.890	0.6
1999	0.555	11.262	10.591	2.616	5.255	1.298	0.5
2000	0.555	10.981	9.721	2.401	4.036	0.997	0.4
2001	0.555	9.214	11.599	2.865	5.567	1.375	0.5
2002	0.555	12.238	9.065	2.239	4.846	1.197	0.5
2003	0.555	13.150	10.213	2.523	4.890	1.208	0.5
2004	0.555	12.099	10.460	2.584	5.243	1.295	0.5
2005	0.555	13.601	16.569	4.092	6.990	1.727	0.4
2006	0.555	15.648	29.064	7.179	14.801	3.656	0.5
2007	0.225	8.544	6.842	1.690	27.382	6.763	4.0
2008	0.246	8.598	6.763	1.670	27.255	6.732	4.0
2009	0.246	12.487	11.518	2.845	51.446	12.707	4.5
2010	0.246	18.723	18.386	4.541	94.353	23.305	5.1
2011	0.246	21.726	19.813	4.894	113.362	28.001	5.7
2012	0.246	21.279	18.272	4.513	106.580	26.325	5.8
2013	0.246	24.330	22.910	5.659	136.003	33.594	5.9
2014	0.406	24.698	29.729	7.343	181.826	44.910	6.1
2015	0.406	22.529	50.044	12.361	244.788	60.464	4.9
2016	0.406	29.146	50.368	12.441	196.138	48.447	3.9
2017	0.406	28.138	62.472	15.430	240.945	59.514	3.9
2018	0.406	25.139	59.736	14.754	263.600	65.109	4.4
2019	0.406	24.532	64.003	15.809	332.452	82.115	5.2

**Table 44.** Gulf of Mexico Red Snapper Commercial Longline West discards in numbers. Discards refer to the total number of fish discarded before applying the discard mortality rate. In SEDAR 74, catches were modelled as total catch, by summing the landings with the dead discards.

Year	Input N SE	Input N	Exp N	Exp Dead N	Exp B	Exp Dead B	MW
1995	0.555	1.608	0.463	0.102	1.383	0.306	3.0
1996	0.555	1.031	0.609	0.135	1.910	0.422	3.1
1997	0.555	0.662	0.581	0.128	1.978	0.437	3.4
1998	0.555	0.744	0.472	0.104	1.689	0.373	3.6
1999	0.555	2.331	1.496	0.330	5.294	1.170	3.5
2000	0.555	2.014	2.972	0.657	9.698	2.143	3.3
2001	0.555	1.192	1.901	0.420	6.453	1.426	3.4
2002	0.555	1.881	2.130	0.471	7.652	1.691	3.6
2003	0.555	3.543	2.549	0.563	9.079	2.007	3.6
2004	0.555	5.295	6.985	1.544	22.516	4.976	3.2
2005	0.555	4.387	5.161	1.141	15.124	3.342	2.9
2006	0.555	4.110	5.502	1.216	15.225	3.364	2.8
2007	0.750	0.878	7.007	1.549	63.258	13.980	9.0
2008	0.750	1.808	2.132	0.471	18.961	4.191	8.9
2009	0.750	3.042	1.899	0.420	17.463	3.859	9.2
2010	0.750	1.090	1.385	0.306	12.890	2.849	9.3
2011	0.750	0.364	0.630	0.139	6.157	1.361	9.8
2012	0.750	0.858	0.452	0.100	4.552	1.006	10.1
2013	0.750	2.955	1.647	0.364	17.071	3.773	10.4
2014	0.750	1.844	1.738	0.384	18.616	4.114	10.7
2015	0.750	5.293	1.535	0.339	16.851	3.724	11.0
2016	0.750	3.057	2.138	0.472	23.917	5.286	11.2
2017	0.750	3.195	1.920	0.424	22.031	4.869	11.5
2018	0.750	1.175	1.901	0.420	22.268	4.921	11.7
2019	0.750	3.163	4.442	0.982	52.686	11.643	11.9

**Table 45.** Gulf of Mexico Red Snapper Commercial Longline Central discards in numbers. Discards refer to the total number of fish discarded before applying the discard mortality rate. In SEDAR 74, catches were modelled as total catch, by summing the landings with the dead discards.

Year	Input N SE	Input N	Exp N	Exp Dead N	Exp B	Exp Dead B	MW
1995	0.555	0.048	0.040	0.016	0.053	0.022	1.3
1996	0.555	0.074	0.144	0.059	0.189	0.077	1.3
1997	0.555	0.065	0.079	0.032	0.096	0.039	1.2
1998	0.555	0.052	0.120	0.049	0.167	0.068	1.4
1999	0.555	0.051	0.027	0.011	0.044	0.018	1.6
2000	0.555	0.054	0.036	0.014	0.052	0.021	1.5
2001	0.555	0.062	0.025	0.010	0.035	0.014	1.4
2002	0.555	0.092	0.215	0.088	0.311	0.127	1.4
2003	0.555	0.094	0.139	0.057	0.198	0.081	1.4
2004	0.555	0.138	0.161	0.066	0.222	0.090	1.4
2005	0.555	0.094	0.091	0.037	0.119	0.048	1.3
2006	0.555	0.117	0.082	0.033	0.100	0.041	1.2
2007	0.218	2.798	2.146	0.873	11.620	4.729	5.4
2008	0.218	2.916	3.539	1.441	20.763	8.450	5.9
2009	0.218	1.087	1.026	0.418	7.198	2.930	7.0
2010	0.218	1.515	1.547	0.629	12.171	4.953	7.9
2011	0.218	0.804	0.594	0.242	5.228	2.128	8.8
2012	0.218	0.206	0.150	0.061	1.429	0.582	9.5
2013	0.218	0.310	0.254	0.103	2.520	1.026	9.9
2014	0.218	1.242	0.855	0.348	8.803	3.583	10.3
2015	0.218	3.907	4.116	1.675	42.800	17.420	10.4
2016	0.218	1.833	2.210	0.899	22.746	9.258	10.3
2017	0.218	0.706	0.783	0.319	7.773	3.164	9.9
2018	0.218	3.390	5.076	2.066	48.784	19.855	9.6
2019	0.218	2.201	3.705	1.508	35.039	14.261	9.5

**Table 46.** Gulf of Mexico Red Snapper Commercial Longline East discards in numbers. Discards refer to the total number of fish discarded before applying the discard mortality rate. In SEDAR 74, catches were modelled as total catch, by summing the landings with the dead discards.

Year	Input N SE	Input N	Exp N	Exp Dead N	Exp B	Exp Dead B	MW
1995	0.555	2.106	0.918	0.242	0.615	0.162	0.7
1996	0.555	3.343	0.590	0.156	0.327	0.086	0.6
1997	0.555	3.238	0.970	0.256	0.584	0.154	0.6
1998	0.555	2.528	0.667	0.176	0.495	0.131	0.7
1999	0.555	3.432	0.585	0.154	0.425	0.112	0.7
2000	0.555	2.959	0.863	0.228	0.523	0.138	0.6
2001	0.555	2.660	1.145	0.302	0.752	0.199	0.7
2002	0.555	3.151	1.087	0.287	0.781	0.206	0.7
2003	0.555	2.831	0.716	0.189	0.491	0.129	0.7
2004	0.555	3.604	1.069	0.282	0.731	0.193	0.7
2005	0.555	3.151	1.361	0.359	0.849	0.224	0.6
2006	0.555	4.153	1.691	0.446	1.143	0.302	0.7
2007	0.216	2.686	1.090	0.288	7.473	1.973	6.9
2008	0.216	3.437	2.773	0.732	18.388	4.854	6.6
2009	0.216	1.560	1.510	0.399	10.202	2.693	6.8
2010	0.216	10.052	11.233	2.965	80.075	21.140	7.1
2011	0.216	13.312	12.562	3.316	97.496	25.739	7.8
2012	0.216	8.534	7.654	2.021	63.675	16.810	8.3
2013	0.216	14.302	15.466	4.083	134.439	35.492	8.7
2014	0.216	17.923	15.817	4.176	141.579	37.377	9.0
2015	0.216	26.677	29.038	7.666	261.163	68.946	9.0
2016	0.216	26.989	25.300	6.679	204.313	53.939	8.1
2017	0.216	27.870	30.984	8.180	210.533	55.582	6.8
2018	0.216	27.553	46.942	12.393	311.090	82.129	6.6
2019	0.216	33.807	65.131	17.194	461.736	121.898	7.1



**Table 47.** Gulf of Mexico Red Snapper Commercial Handline Closed Season Discards West discards in numbers. Discards refer to the total number of fish discarded before applying the discard mortality rate. In SEDAR 74, catches were modelled as total catch, by summing the landings with the dead discards.

Year	Input N SE	Input N	Exp N	Exp Dead N	Exp B	Exp Dead B	MW
1995	0.555	97.838	93.201	19.759	201.112	42.636	2.2
1996	0.555	86.784	83.277	17.655	191.846	40.671	2.3
1997	0.555	146.697	140.626	29.813	345.691	73.287	2.5
1998	0.555	112.030	109.903	23.299	282.683	59.929	2.6
1999	0.555	141.937	138.581	29.379	336.559	71.350	2.4
2000	0.555	140.452	140.140	29.710	330.792	70.128	2.4
2001	0.555	96.650	96.540	20.467	240.063	50.893	2.5
2002	0.555	113.240	113.180	23.994	293.572	62.237	2.6
2003	0.555	113.700	115.615	24.510	284.475	60.309	2.5
2004	0.555	89.771	90.845	19.259	202.800	42.994	2.2
2005	0.555	71.675	72.729	15.419	152.584	32.348	2.1
2006	0.555	44.702	45.148	9.571	92.528	19.616	2.0

**Table 48.** Gulf of Mexico Red Snapper Commercial Handline Closed Season Discards Central discards in numbers. Discards refer to the total number of fish discarded before applying the discard mortality rate. In SEDAR 74, catches were modelled as total catch, by summing the landings with the dead discards.

Year	Input N SE	Input N	Exp N	Exp Dead N	Exp B	Exp Dead B	MW
1995	0.555	814.917	623.461	119.705	1,133.821	217.694	1.8
1996	0.555	776.910	670.714	128.777	1,028.219	197.418	1.5
1997	0.555	625.567	571.326	109.695	834.596	160.242	1.5
1998	0.555	613.507	575.080	110.415	1,007.458	193.432	1.8
1999	0.555	715.912	687.119	131.927	1,374.380	263.880	2.0
2000	0.555	568.572	602.177	115.618	1,154.650	221.692	1.9
2001	0.555	524.182	503.319	96.637	949.126	182.232	1.9
2002	0.555	506.465	496.779	95.382	942.570	180.974	1.9
2003	0.555	602.113	603.915	115.952	1,092.863	209.830	1.8
2004	0.555	462.990	484.791	93.080	848.377	162.888	1.7
2005	0.555	320.799	341.833	65.632	500.907	96.174	1.5
2006	0.555	341.403	360.550	69.226	527.435	101.268	1.5

**Table 49.** Gulf of Mexico Red Snapper Commercial Handline Closed Season Discards East discards in numbers. Discards refer to the total number of fish discarded before applying the discard mortality rate. In SEDAR 74, catches were modelled as total catch, by summing the landings with the dead discards.

Year	Input N SE	Input N	Exp N	Exp Dead N	Exp B	Exp Dead B	MW
1995	0.555	49.407	52.116	12.873	110.262	27.235	2.1
1996	0.555	44.801	46.038	11.371	80.175	19.803	1.7
1997	0.555	45.591	46.334	11.445	64.637	15.965	1.4
1998	0.555	40.922	41.351	10.214	78.340	19.350	1.9
1999	0.555	45.994	46.839	11.569	117.747	29.084	2.5
2000	0.555	43.318	45.135	11.148	102.522	25.323	2.3
2001	0.555	35.597	36.903	9.115	83.621	20.654	2.3
2002	0.555	34.744	35.775	8.836	94.511	23.344	2.6
2003	0.555	30.947	31.507	7.782	92.518	22.852	2.9
2004	0.555	47.398	48.496	11.979	146.438	36.170	3.0
2005	0.555	24.559	24.791	6.123	68.918	17.023	2.8
2006	0.555	26.249	26.392	6.519	62.192	15.361	2.4

**Table 50.** Gulf of Mexico Red Snapper Commercial Longline Closed Season Discards West discards in numbers. Discards refer to the total number of fish discarded before applying the discard mortality rate. In SEDAR 74, catches were modelled as total catch, by summing the landings with the dead discards.

Year	Input N SE	Input N	Exp N	Exp Dead N	Exp B	Exp Dead B	MW
1995	0.555	0.710	0.709	0.157	5.670	1.253	8.0
1996	0.555	0.564	0.563	0.124	4.574	1.011	8.1
1997	0.555	0.348	0.348	0.077	2.909	0.643	8.4
1998	0.555	0.398	0.397	0.088	3.439	0.760	8.7
1999	0.555	0.786	0.785	0.173	6.953	1.537	8.9
2000	0.555	0.590	0.589	0.130	5.177	1.144	8.8
2001	0.555	0.410	0.409	0.090	3.634	0.803	8.9
2002	0.555	0.517	0.517	0.114	4.674	1.033	9.0
2003	0.555	0.656	0.655	0.145	5.997	1.325	9.2
2004	0.555	0.560	0.560	0.124	5.053	1.117	9.0
2005	0.555	0.465	0.465	0.103	4.060	0.897	8.7
2006	0.555	0.334	0.334	0.074	2.758	0.609	8.3

**Table 51.** Gulf of Mexico Red Snapper Commercial Longline Closed Season Discards Central discards in numbers. Discards refer to the total number of fish discarded before applying the discard mortality rate. In SEDAR 74, catches were modelled as total catch, by summing the landings with the dead discards.

Year	Input N SE	Input N	Exp N	Exp Dead N	Exp B	Exp Dead B	MW
1995	0.555	0.596	0.594	0.242	3.603	1.466	6.1
1996	0.555	0.531	0.530	0.216	2.976	1.211	5.6
1997	0.555	0.588	0.587	0.239	2.669	1.086	4.5
1998	0.555	0.410	0.410	0.167	1.845	0.751	4.5
1999	0.555	0.275	0.274	0.112	1.383	0.563	5.0
2000	0.555	0.534	0.534	0.217	2.889	1.176	5.4
2001	0.555	0.507	0.507	0.206	2.826	1.150	5.6
2002	0.555	0.498	0.497	0.202	2.743	1.116	5.5
2003	0.555	0.642	0.641	0.261	3.386	1.378	5.3
2004	0.555	0.404	0.404	0.165	2.036	0.828	5.0
2005	0.555	0.430	0.430	0.175	2.081	0.847	4.8
2006	0.555	0.403	0.403	0.164	1.753	0.713	4.3

**Table 52.** Gulf of Mexico Red Snapper Commercial Longline Closed Season Discards East discards in numbers. Discards refer to the total number of fish discarded before applying the discard mortality rate. In SEDAR 74, catches were modelled as total catch, by summing the landings with the dead discards.

Year	Input N SE	Input N	Exp N	Exp Dead N	Exp B	Exp Dead B	MW
1995	0.555	10.629	12.486	3.296	51.396	13.569	4.1
1996	0.555	10.996	11.648	3.075	42.318	11.172	3.6
1997	0.555	13.103	13.260	3.501	36.757	9.704	2.8
1998	0.555	13.039	12.946	3.418	41.369	10.922	3.2
1999	0.555	14.040	14.140	3.733	57.662	15.223	4.1
2000	0.555	11.891	14.098	3.722	56.806	14.997	4.0
2001	0.555	11.817	15.223	4.019	62.549	16.513	4.1
2002	0.555	9.608	11.587	3.059	53.537	14.134	4.6
2003	0.555	10.705	12.699	3.353	65.735	17.354	5.2
2004	0.555	9.411	10.552	2.786	56.953	15.036	5.4
2005	0.555	6.199	6.596	1.741	35.559	9.387	5.4
2006	0.555	7.622	8.006	2.114	37.049	9.781	4.6

**Table 53.** Input (with log-scale standard errors, SE) and expected (Exp) discards for the Recreational Charter West fleet in number (N, 1,000s of fish) and biomass (B, thousand pounds whole weight) for Gulf of Mexico Red Snapper. Dead discards in numbers (discard mortality rate = 0.412), dead discards in biomass, and mean weight (MW, whole pounds per fish) are included. Mean weight was determined by dividing the expected discards in weights by the expected discards in numbers.

Year	Input N SE	Input N	Exp N	Exp Dead N	Exp B	Exp Dead B	MW
1982	0.82	13.00	2.53	1.04	0.36	0.15	0.10
1983	0.65	1.53	3.68	1.52	0.49	0.20	0.10
1984	0.83	0.01	2.81	1.16	0.38	0.16	0.10
1985	0.78	0.03	3.87	1.59	0.59	0.24	0.20
1986	0.39	2.57	0.87	0.36	0.11	0.04	0.10
1987	0.73	1.80	0.49	0.20	0.08	0.03	0.20
1988	0.74	1.21	0.12	0.05	0.02	0.01	0.20
1989	0.82	4.60	1.28	0.53	0.10	0.04	0.10
1990	0.61	64.07	41.81	17.23	30.16	12.43	0.70
1991	0.32	140.53	127.31	52.45	93.25	38.42	0.70
1992	0.36	111.92	112.41	46.31	82.93	34.17	0.70
1993	0.31	67.21	57.84	23.83	42.87	17.66	0.70
1994	0.31	107.78	57.10	23.52	41.43	17.07	0.70
1995	0.47	89.03	71.82	29.59	69.73	28.73	1.00
1996	0.44	90.82	61.91	25.50	68.57	28.25	1.10
1997	0.32	61.02	55.29	22.78	62.93	25.93	1.10
1998	0.46	47.40	63.89	26.32	71.56	29.48	1.10
1999	0.50	12.32	35.45	14.61	48.82	20.11	1.40
2000	0.33	8.45	15.24	6.28	14.96	6.16	1.00
2001	0.52	15.10	17.98	7.41	19.30	7.95	1.10
2002	0.35	36.58	44.96	18.52	47.77	19.68	1.10
2003	0.28	55.88	58.73	24.20	53.15	21.90	0.90
2004	0.30	177.15	136.09	56.07	115.89	47.74	0.90
2005	0.31	166.53	132.32	54.52	118.15	48.68	0.90
2006	0.26	188.84	152.11	62.67	146.36	60.30	1.00
2007	0.22	121.51	78.69	32.42	60.95	25.11	0.80
2008	0.24	39.65	29.29	12.07	29.19	12.03	1.00
2009	0.09	13.88	13.75	5.66	11.46	4.72	0.80
2010	0.06	20.18	19.41	8.00	17.43	7.18	0.90

**Table 53 Continued.** Input (with log-scale standard errors, SE) and expected (Exp) discards for the Recreational Charter West fleet in number (N, 1,000s of fish) and biomass (B, thousand pounds whole weight) for Gulf of Mexico Red Snapper. Dead discards in numbers (discard mortality rate = 0.412), dead discards in biomass, and mean weight (MW, whole pounds per fish) are included. Mean weight was determined by dividing the expected discards in weights by the expected discards in numbers.

Year	Input N SE	Input N	Exp N	Exp Dead N	Exp B	Exp Dead B	MW
2011	0.05	4.56	4.54	1.87	3.99	1.64	0.90
2012	0.09	7.70	7.74	3.19	6.31	2.60	0.80
2013	0.05	11.48	11.40	4.70	10.31	4.25	0.90
2014	0.05	3.61	3.57	1.47	3.39	1.40	0.90
2015	0.05	8.45	8.33	3.43	7.01	2.89	0.80
2016	0.05	6.60	6.96	2.87	6.15	2.53	0.90
2017	0.07	4.60	5.30	2.18	5.10	2.10	1.00
2018	0.05	2.99	3.15	1.30	2.75	1.13	0.90
2019	0.06	15.86	14.32	5.90	12.98	5.35	0.90



**Table 54.** Input (with log-scale standard errors, SE) and expected (Exp) discards for the Recreational Charter Central fleet in number (N, 1,000s of fish) and biomass (B, thousand pounds whole weight) for Gulf of Mexico Red Snapper. Dead discards in numbers (discard mortality rate = 0.169), dead discards in biomass, and mean weight (MW, whole pounds per fish) are included. Mean weight was determined by dividing the expected discards in weights by the expected discards in numbers.

Year	Input N SE	Input N	Exp N	Exp Dead N	Exp B	Exp Dead B	MW
1981	0.64	0.49	3.85	0.65	0.38	0.06	0.10
1982	0.83	7.74	35.62	6.02	2.79	0.47	0.10
1984	0.83	3.78	21.13	3.57	1.89	0.32	0.10
1985	0.83	2.29	18.79	3.18	1.93	0.33	0.10
1986	0.58	7.33	24.98	4.22	3.19	0.54	0.10
1987	0.38	42.60	44.12	7.46	2.83	0.48	0.10
1988	0.74	64.91	32.61	5.51	3.45	0.58	0.10
1989	0.43	35.09	40.35	6.82	2.27	0.38	0.10
1990	0.38	80.69	133.37	22.54	76.78	12.98	0.60
1991	0.28	196.02	171.38	28.96	104.54	17.67	0.60
1992	0.20	317.61	281.20	47.52	183.91	31.08	0.70
1993	0.43	260.03	447.24	75.58	307.30	51.92	0.70
1994	0.24	273.36	228.56	38.63	131.10	22.16	0.60
1995	0.41	401.69	148.13	25.04	342.79	57.93	2.30
1996	0.28	486.47	262.24	44.32	556.84	94.11	2.10
1997	0.25	833.41	393.32	66.47	817.97	138.24	2.10
1998	0.11	588.80	522.66	88.33	1,196.20	202.16	2.30
1999	0.09	715.19	661.66	111.82	1,716.74	290.13	2.60
2000	0.08	369.34	299.92	50.69	749.62	126.68	2.50
2001	0.10	472.44	337.60	57.05	825.62	139.52	2.40
2002	0.09	465.10	410.02	69.29	999.58	168.94	2.40
2003	0.09	498.26	420.95	71.14	1,010.22	170.73	2.40
2004	0.09	531.11	447.76	75.67	1,057.51	178.73	2.40
2005	0.09	484.19	395.99	66.92	866.86	146.50	2.20
2006	0.11	651.50	466.08	78.77	1,005.03	169.85	2.20
2007	0.11	581.52	508.70	85.97	1,437.59	242.95	2.80
2008	0.09	166.67	178.87	30.23	561.25	94.85	3.10
2009	0.05	213.61	206.80	34.95	725.04	122.53	3.50
2010	0.06	55.90	54.57	9.22	210.92	35.65	3.90

**Table 54 Continued.** Input (with log-scale standard errors, SE) and expected (Exp) discards for the Recreational Charter Central fleet in number (N, 1,000s of fish) and biomass (B, thousand pounds whole weight) for Gulf of Mexico Red Snapper. Dead discards in numbers (discard mortality rate = 0.169), dead discards in biomass, and mean weight (MW, whole pounds per fish) are included. Mean weight was determined by dividing the expected discards in weights by the expected discards in numbers.

Year	Input N SE	Input N	Exp N	Exp Dead N	Exp B	Exp Dead B	MW
2011	0.05	99.76	99.36	16.79	414.65	70.08	4.20
2012	0.08	65.41	68.22	11.53	295.18	49.88	4.30
2013	0.05	77.99	78.11	13.20	341.69	57.75	4.40
2014	0.05	12.23	12.38	2.09	52.79	8.92	4.30
2015	0.05	63.24	64.54	10.91	267.03	45.13	4.10
2016	0.05	116.90	117.00	19.77	462.89	78.23	4.00
2017	0.05	184.25	183.12	30.95	693.54	117.21	3.80
2018	0.05	128.46	128.92	21.79	485.44	82.04	3.80
2019	0.05	158.79	159.35	26.93	626.76	105.92	3.90

**Table 55.** Input (with log-scale standard errors, SE) and expected (Exp) discards for the Recreational Charter East fleet in number (N, 1,000s of fish) and biomass (B, thousand pounds whole weight) for Gulf of Mexico Red Snapper. Dead discards in numbers (discard mortality rate = 0.268), dead discards in biomass, and mean weight (MW, whole pounds per fish) are included. Mean weight was determined by dividing the expected discards in weights by the expected discards in numbers.

Year	Input N SE	Input N	Exp N	Exp Dead N	Exp B	Exp Dead B	MW
1982	0.83	0.40	0.10	0.03	0.01	0.00	0.10
1984	0.83	3.59	1.09	0.29	0.09	0.02	0.10
1985	0.83	1.01	0.46	0.12	0.06	0.01	0.10
1986	0.43	17.13	4.08	1.09	0.40	0.11	0.10
1987	0.83	1.64	0.20	0.05	0.03	0.01	0.10
1992	0.62	1.02	1.35	0.36	0.72	0.19	0.50
1994	0.83	0.06	0.05	0.01	0.03	0.01	0.60
1997	0.83	0.23	0.28	0.07	0.26	0.07	0.90
1998	0.50	2.89	2.10	0.56	2.52	0.68	1.20
1999	0.69	1.92	0.90	0.24	1.90	0.51	2.10
2000	0.66	0.17	0.12	0.03	0.18	0.05	1.50
2001	0.65	0.08	0.18	0.05	0.27	0.07	1.50
2003	0.77	0.30	0.30	0.08	0.48	0.13	1.60
2005	0.56	0.52	0.40	0.11	0.61	0.16	1.50
2006	0.50	7.99	10.91	2.92	16.30	4.37	1.50
2007	0.58	0.23	0.34	0.09	1.42	0.38	4.10
2008	0.07	2.38	2.39	0.64	10.06	2.69	4.20
2009	0.06	4.88	4.83	1.29	21.77	5.84	4.50
2010	0.10	1.81	1.82	0.49	9.21	2.47	5.10
2012	0.05	0.62	0.63	0.17	3.78	1.01	6.00
2013	0.05	4.88	4.82	1.29	29.69	7.96	6.20
2014	0.05	1.13	1.13	0.30	6.95	1.86	6.10
2015	0.05	5.52	5.52	1.48	31.28	8.38	5.70
2016	0.05	5.40	5.41	1.45	23.98	6.43	4.40
2017	0.05	14.47	14.51	3.89	59.66	15.99	4.10
2018	0.05	15.93	15.96	4.28	71.48	19.16	4.50
2019	0.05	9.61	9.65	2.59	49.85	13.36	5.20

**Table 56.** Input (with log-scale standard errors, SE) and expected (Exp) discards for the Recreational Headboat West fleet in number (N, 1,000s of fish) and biomass (B, thousand pounds whole weight) for Gulf of Mexico Red Snapper. Dead discards in numbers (discard mortality rate = 0.406), dead discards in biomass, and mean weight (MW, whole pounds per fish) are included. Mean weight was determined by dividing the expected discards in weights by the expected discards in numbers.

Year	Input N SE	Input N	Exp N	Exp Dead N	Exp B	Exp Dead B	MW
1982	0.82	18.09	4.71	1.91	1.35	0.55	0.30
1983	0.65	0.13	3.62	1.47	1.03	0.42	0.30
1984	0.83	19.58	4.97	2.02	1.41	0.57	0.30
1985	0.78	15.66	5.11	2.08	1.47	0.60	0.30
1986	0.39	2.85	3.55	1.44	1.00	0.41	0.30
1987	0.73	2.43	3.78	1.54	1.09	0.44	0.30
1988	0.74	9.28	4.72	1.92	1.36	0.55	0.30
1989	0.82	7.36	4.64	1.88	1.20	0.49	0.30
1990	0.61	114.39	325.86	132.30	220.25	89.42	0.70
1991	0.32	87.51	275.61	111.90	190.66	77.41	0.70
1992	0.36	102.00	378.94	153.85	263.67	107.05	0.70
1993	0.31	102.38	300.23	121.89	212.40	86.23	0.70
1994	0.31	254.27	444.45	180.44	306.77	124.55	0.70
1995	0.47	116.36	171.81	69.75	355.70	144.41	2.10
1996	0.44	150.72	147.28	59.80	308.96	125.44	2.10
1997	0.32	85.01	130.66	53.05	280.95	114.06	2.20
1998	0.46	30.06	115.79	47.01	251.68	102.18	2.20
1999	0.50	6.08	71.68	29.10	148.87	60.44	2.10
2000	0.33	14.75	45.63	18.52	81.70	33.17	1.80
2001	0.52	24.75	62.00	25.17	112.43	45.65	1.80
2002	0.35	26.04	75.69	30.73	138.67	56.30	1.80
2003	0.28	45.14	56.40	22.90	102.52	41.62	1.80
2004	0.30	65.34	71.47	29.02	127.26	51.67	1.80
2005	0.31	72.08	73.54	29.86	130.08	52.81	1.80
2006	0.26	70.06	82.61	33.54	146.98	59.67	1.80
2007	0.22	58.53	60.06	24.38	55.87	22.68	0.90
2008	0.45	41.53	22.66	9.20	28.68	11.64	1.30
2009	0.48	30.97	20.54	8.34	22.72	9.22	1.10
2010	0.83	18.41	12.59	5.11	14.85	6.03	1.20

**Table 56 Continued.** Input (with log-scale standard errors, SE) and expected (Exp) discards for the Recreational Headboat West fleet in number (N, 1,000s of fish) and biomass (B, thousand pounds whole weight) for Gulf of Mexico Red Snapper. Dead discards in numbers (discard mortality rate = 0.406), dead discards in biomass, and mean weight (MW, whole pounds per fish) are included. Mean weight was determined by dividing the expected discards in weights by the expected discards in numbers.

Year	Input N SE	Input N	Exp N	Exp Dead N	Exp B	Exp Dead B	MW
2011	0.67	23.09	10.78	4.38	12.63	5.13	1.20
2012	0.41	15.91	12.46	5.06	13.41	5.44	1.10
2013	0.50	9.85	9.33	3.79	11.04	4.48	1.20
2014	0.33	8.57	6.71	2.72	8.45	3.43	1.30
2015	0.26	9.71	12.45	5.05	13.97	5.67	1.10
2016	0.23	9.78	12.12	4.92	14.11	5.73	1.20
2017	0.18	10.28	10.48	4.26	13.42	5.45	1.30
2018	0.21	9.50	11.23	4.56	13.16	5.34	1.20
2019	0.23	11.31	12.51	5.08	14.97	6.08	1.20

**Table 57.** Input (with log-scale standard errors, SE) and expected (Exp) discards for the Recreational Headboat Central fleet in number (N, 1,000s of fish) and biomass (B, thousand pounds whole weight) for Gulf of Mexico Red Snapper. Dead discards in numbers (discard mortality rate = 0.244), dead discards in biomass, and mean weight (MW, whole pounds per fish) are included. Mean weight was determined by dividing the expected discards in weights by the expected discards in numbers.

Year	Input N SE	Input N	Exp N	Exp Dead N	Exp B	Exp Dead B	MW
1981	0.64	0.30	1.40	0.34	0.12	0.03	0.10
1982	0.83	4.84	13.42	3.27	0.88	0.21	0.10
1984	0.83	2.37	7.42	1.81	0.55	0.13	0.10
1985	0.83	1.43	6.33	1.54	0.54	0.13	0.10
1986	0.58	0.14	0.36	0.09	0.04	0.01	0.10
1987	0.38	0.55	0.55	0.14	0.03	0.01	0.10
1988	0.74	1.49	0.62	0.15	0.06	0.01	0.10
1989	0.43	1.14	1.25	0.30	0.06	0.01	0.00
1990	0.38	5.51	11.90	2.90	8.10	1.98	0.70
1991	0.28	10.10	11.36	2.77	7.96	1.94	0.70
1992	0.20	19.40	21.57	5.26	15.74	3.84	0.70
1993	0.43	7.27	18.44	4.50	13.77	3.36	0.70
1994	0.24	13.40	15.86	3.87	10.45	2.55	0.70
1995	0.41	19.78	17.09	4.17	33.16	8.09	1.90
1996	0.28	20.72	20.93	5.11	40.60	9.91	1.90
1997	0.25	48.05	40.41	9.86	75.47	18.41	1.90
1998	0.11	37.80	43.44	10.60	83.87	20.46	1.90
1999	0.09	55.91	61.52	15.01	127.36	31.07	2.10
2000	0.08	48.14	48.67	11.87	80.05	19.53	1.60
2001	0.10	46.24	47.28	11.54	77.32	18.86	1.60
2002	0.09	47.61	51.74	12.62	85.07	20.76	1.60
2003	0.09	48.92	50.47	12.31	82.91	20.23	1.60
2004	0.09	45.55	47.17	11.51	77.13	18.82	1.60
2005	0.09	39.29	39.63	9.67	64.70	15.79	1.60
2006	0.11	61.51	61.52	15.01	99.07	24.17	1.60
2007	0.11	57.59	60.34	14.72	94.02	22.94	1.60
2008	0.11	94.05	100.91	24.62	203.13	49.56	2.00
2009	0.12	94.20	105.97	25.86	255.86	62.43	2.40
2010	0.15	52.80	48.11	11.74	125.82	30.70	2.60

**Table 57 Continued.** Input (with log-scale standard errors, SE) and expected (Exp) discards for the Recreational Headboat Central fleet in number (N, 1,000s of fish) and biomass (B, thousand pounds whole weight) for Gulf of Mexico Red Snapper. Dead discards in numbers (discard mortality rate = 0.244), dead discards in biomass, and mean weight (MW, whole pounds per fish) are included. Mean weight was determined by dividing the expected discards in weights by the expected discards in numbers.

Year	Input N SE	Input N	Exp N	Exp Dead N	Exp B	Exp Dead B	MW
2011	0.12	82.10	83.75	20.43	251.51	61.37	3.00
2012	0.12	71.58	70.46	17.19	207.37	50.60	2.90
2013	0.21	80.01	63.36	15.46	178.88	43.65	2.80
2014	0.17	59.83	61.06	14.90	168.79	41.19	2.80
2015	0.15	53.35	69.08	16.86	171.88	41.94	2.50
2016	0.19	81.82	67.00	16.35	152.86	37.30	2.30
2017	0.20	115.41	89.29	21.79	209.61	51.15	2.30
2018	0.15	95.23	87.08	21.25	217.11	52.98	2.50
2019	0.25	77.43	59.84	14.60	159.57	38.94	2.70

**Table 58.** Input (with log-scale standard errors, SE) and expected (Exp) discards for the Recreational Headboat East fleet in number (N, 1,000s of fish) and biomass (B, thousand pounds whole weight) for Gulf of Mexico Red Snapper. Dead discards in numbers (discard mortality rate = 0.279), dead discards in biomass, and mean weight (MW, whole pounds per fish) are included. Mean weight was determined by dividing the expected discards in weights by the expected discards in numbers.

Year	Input N SE	Input N	Exp N	Exp Dead N	Exp B	Exp Dead B	MW
1982	0.83	0.25	0.04	0.01	0.00	0.00	0.10
1984	0.83	2.25	0.51	0.14	0.04	0.01	0.10
1985	0.83	0.63	0.19	0.05	0.02	0.01	0.10
1986	0.43	0.12	0.06	0.02	0.00	0.00	0.10
1987	0.83	0.06	0.01	0.00	0.00	0.00	0.10
1992	0.62	0.00	0.02	0.01	0.01	0.00	0.70
1994	0.83	0.07	0.18	0.05	0.13	0.04	0.70
1997	0.83	0.00	0.01	0.00	0.02	0.01	1.40
1998	0.50	0.03	0.06	0.01	0.08	0.02	1.50
1999	0.69	1.89	4.51	1.26	8.87	2.48	2.00
2000	0.66	0.24	0.45	0.12	0.73	0.20	1.60
2001	0.65	0.50	0.64	0.18	1.03	0.29	1.60
2003	0.77	0.25	0.29	0.08	0.48	0.13	1.70
2004	0.50	0.67	0.82	0.23	1.34	0.37	1.60
2005	0.56	1.36	2.87	0.80	4.69	1.31	1.60
2006	0.50	0.54	0.81	0.23	1.30	0.36	1.60
2007	0.58	0.59	1.23	0.34	2.86	0.80	2.30
2008	0.68	3.92	2.34	0.65	5.98	1.67	2.60
2009	0.59	5.84	4.22	1.18	13.48	3.76	3.20
2010	0.68	1.53	2.33	0.65	8.61	2.40	3.70
2011	0.80	6.29	3.62	1.01	14.34	4.00	4.00
2012	0.76	2.10	3.14	0.88	12.29	3.43	3.90
2013	0.78	1.57	3.22	0.90	13.55	3.78	4.20
2014	0.51	1.82	3.35	0.94	11.28	3.15	3.40
2015	0.60	1.49	7.82	2.18	17.67	4.93	2.30
2016	0.41	11.35	6.11	1.70	14.44	4.03	2.40
2017	0.64	15.27	13.11	3.66	35.91	10.02	2.70
2018	0.36	14.26	10.91	3.04	36.23	10.11	3.30
2019	0.37	12.68	9.86	2.75	37.59	10.49	3.80



**Table 59.** Input (with log-scale standard errors, SE) and expected (Exp) discards for the Recreational Private West fleet in number (N, 1,000s of fish) and biomass (B, thousand pounds whole weight) for Gulf of Mexico Red Snapper. Dead discards in numbers (discard mortality rate = 0.355), dead discards in biomass, and mean weight (MW, whole pounds per fish) are included. Mean weight was determined by dividing the expected discards in weights by the expected discards in numbers.

Year	Input N SE	Input N	Exp N	Exp Dead N	Exp B	Exp Dead B	MW
1981	0.54	63.44	216.82	76.97	33.97	12.06	0.20
1982	0.58	6.49	109.80	38.98	17.95	6.37	0.20
1983	0.86	0.69	224.69	79.77	35.52	12.61	0.20
1984	0.76	43.56	60.93	21.63	9.73	3.46	0.20
1985	0.65	204.99	99.63	35.37	16.91	6.02	0.20
1986	0.79	38.58	122.77	43.58	18.98	6.72	0.20
1987	0.82	120.04	36.15	12.83	6.24	2.22	0.20
1988	0.51	529.27	59.10	20.98	9.97	3.54	0.20
1989	0.51	371.12	66.08	23.46	7.41	2.63	0.10
1990	0.64	422.26	616.64	218.91	392.16	139.22	0.60
1991	0.82	410.62	566.50	201.11	378.75	134.46	0.70
1992	0.32	450.63	590.88	209.77	404.82	143.71	0.70
1993	0.31	528.83	656.77	233.15	457.80	162.51	0.70
1994	0.50	1,213.19	923.49	327.84	600.87	213.32	0.70
1995	0.46	1,942.65	911.26	323.50	977.13	346.88	1.10
1996	0.47	413.06	619.42	219.90	736.70	261.54	1.20
1997	0.48	477.80	666.83	236.73	809.69	287.44	1.20
1998	0.50	739.98	674.78	239.54	808.50	287.02	1.20
1999	0.39	1,786.42	1,232.01	437.36	1,792.93	636.50	1.50
2000	0.39	542.97	770.64	273.57	913.23	324.20	1.20
2001	0.47	402.47	520.78	184.88	663.68	235.60	1.30
2002	0.66	643.37	485.75	172.44	620.10	220.13	1.30
2003	0.61	1,347.95	553.28	196.41	625.55	222.07	1.10
2004	0.75	2,647.41	621.14	220.50	660.18	234.36	1.10
2005	0.55	1,580.28	1,044.43	370.77	1,141.73	405.32	1.10
2006	0.40	1,769.55	1,328.35	471.57	1,538.03	546.02	1.20
2007	0.36	770.10	925.07	328.40	685.79	243.46	0.70
2008	0.48	564.89	440.78	156.48	485.13	172.22	1.10
2009	0.43	516.49	420.97	149.44	378.12	134.24	0.90

**Table 59 Continued.** Input (with log-scale standard errors, SE) and expected (Exp) discards for the Recreational Private West fleet in number (N, 1,000s of fish) and biomass (B, thousand pounds whole weight) for Gulf of Mexico Red Snapper. Dead discards in numbers (discard mortality rate = 0.355), dead discards in biomass, and mean weight (MW, whole pounds per fish) are included. Mean weight was determined by dividing the expected discards in weights by the expected discards in numbers.

Year	Input N SE	Input N	Exp N	Exp Dead N	Exp B	Exp Dead B	MW
2010	0.87	360.75	227.06	80.61	229.37	81.42	1.00
2011	0.55	353.80	304.21	108.00	303.51	107.75	1.00
2012	0.46	183.27	348.09	123.57	315.77	112.11	0.90
2013	0.45	1,288.67	518.75	184.16	537.07	190.66	1.00
2014	0.32	537.59	414.51	147.15	462.40	164.16	1.10
2015	0.32	609.31	536.79	190.56	517.29	183.65	1.00
2016	0.32	99.17	243.81	86.55	249.29	88.50	1.00
2017	0.27	320.40	345.22	122.55	399.08	141.67	1.20
2018	0.27	380.82	421.66	149.69	433.14	153.75	1.00
2019	0.24	844.18	724.12	257.06	773.58	274.63	1.10

**Table 60.** Input (with log-scale standard errors, SE) and expected (Exp) discards for the Recreational Private Central fleet in number (N, 1,000s of fish) and biomass (B, thousand pounds whole weight) for Gulf of Mexico Red Snapper. Dead discards in numbers (discard mortality rate = 0.297), dead discards in biomass, and mean weight (MW, whole pounds per fish) are included. Mean weight was determined by dividing the expected discards in weights by the expected discards in numbers.

Year	Input N SE	Input N	Exp N	Exp Dead N	Exp B	Exp Dead B	MW
1981	0.65	179.40	195.67	58.11	19.91	5.91	0.10
1982	0.60	13.17	31.63	9.39	2.50	0.74	0.10
1983	0.83	4.47	94.01	27.92	8.94	2.66	0.10
1985	0.83	0.92	61.85	18.37	6.63	1.97	0.10
1986	0.74	13.53	19.77	5.87	2.71	0.80	0.10
1987	0.36	113.80	97.24	28.88	6.24	1.85	0.10
1988	0.45	9.13	35.66	10.59	3.94	1.17	0.10
1989	0.55	323.03	201.16	59.74	11.29	3.35	0.10
1990	0.55	772.21	1,707.53	507.14	819.50	243.39	0.50
1991	0.28	1,587.53	2,786.73	827.66	1,360.66	404.12	0.50
1992	0.17	1,315.58	2,524.68	749.83	1,285.96	381.94	0.50
1993	0.23	1,657.18	2,889.42	858.16	1,497.80	444.85	0.50
1994	0.24	940.42	1,745.24	518.34	781.54	232.12	0.40
1995	0.31	226.08	462.19	137.27	409.51	121.63	0.90
1996	0.26	1,014.85	877.42	260.59	801.79	238.13	0.90
1997	0.25	2,024.07	1,945.96	577.95	1,713.48	508.90	0.90
1998	0.22	831.32	941.68	279.68	864.02	256.61	0.90
1999	0.22	2,312.35	2,659.31	789.81	3,473.91	1,031.76	1.30
2000	0.23	1,316.59	1,723.23	511.80	1,709.64	507.77	1.00
2001	0.19	1,673.86	2,093.54	621.78	2,053.63	609.93	1.00
2002	0.22	3,289.22	3,693.38	1,096.94	3,691.84	1,096.47	1.00
2003	0.20	2,425.09	2,831.27	840.88	2,821.47	837.98	1.00
2004	0.19	3,415.21	4,298.60	1,276.68	4,219.99	1,253.35	1.00
2005	0.18	2,388.49	3,004.66	892.38	2,988.23	887.51	1.00
2006	0.16	2,892.93	3,788.46	1,125.17	3,585.70	1,064.94	0.90
2007	0.16	4,146.94	4,741.30	1,408.17	3,533.98	1,049.60	0.70
2008	0.21	929.75	1,018.30	302.43	1,128.24	335.10	1.10
2009	0.17	1,497.50	1,131.34	336.01	1,468.26	436.07	1.30
2010	0.19	1,024.48	1,029.89	305.88	1,447.16	429.81	1.40

**Table 60 Continued.** Input (with log-scale standard errors, SE) and expected (Exp) discards for the Recreational Private Central fleet in number (N, 1,000s of fish) and biomass (B, thousand pounds whole weight) for Gulf of Mexico Red Snapper. Dead discards in numbers (discard mortality rate = 0.297), dead discards in biomass, and mean weight (MW, whole pounds per fish) are included. Mean weight was determined by dividing the expected discards in weights by the expected discards in numbers.

Year	Input N SE	Input N	Exp N	Exp Dead N	Exp B	Exp Dead B	MW
2011	0.17	881.73	944.51	280.52	1,625.11	482.66	1.70
2012	0.16	684.47	788.90	234.31	1,154.52	342.91	1.50
2013	0.29	1,641.12	1,289.26	382.91	1,805.85	536.34	1.40
2014	0.22	453.37	523.54	155.49	699.64	207.78	1.30
2015	0.19	1,029.77	920.26	273.32	1,030.57	306.09	1.10
2016	0.17	1,533.35	1,341.00	398.28	1,375.95	408.67	1.00
2017	0.17	2,727.02	2,594.06	770.43	3,061.22	909.18	1.20
2018	0.19	1,052.64	1,040.80	309.12	1,327.09	394.14	1.30
2019	0.17	1,186.89	1,329.98	395.00	1,892.34	562.02	1.40

**Table 61.** Input (with log-scale standard errors, SE) and expected (Exp) discards for the Recreational Private East fleet in number (N, 1,000s of fish) and biomass (B, thousand pounds whole weight) for Gulf of Mexico Red Snapper. Dead discards in numbers (discard mortality rate = 0.315), dead discards in biomass, and mean weight (MW, whole pounds per fish) are included. Mean weight was determined by dividing the expected discards in weights by the expected discards in numbers.

Year	Input N SE	Input N	Exp N	Exp Dead N	Exp B	Exp Dead B	MW
1981	0.64	76.36	31.97	10.07	5.56	1.75	0.20
1984	0.70	82.41	1.85	0.58	0.16	0.05	0.10
1985	0.71	41.32	11.33	3.57	1.49	0.47	0.10
1986	0.64	11.69	17.49	5.51	1.80	0.57	0.10
1987	0.64	3.10	7.97	2.51	1.13	0.36	0.10
1988	0.46	35.69	6.69	2.11	0.56	0.18	0.10
1989	0.64	7.02	10.42	3.28	1.60	0.50	0.20
1990	0.83	21.54	118.86	37.44	63.46	19.99	0.50
1991	0.40	78.28	45.62	14.37	24.03	7.57	0.50
1992	0.42	80.07	10.16	3.20	4.93	1.55	0.50
1993	0.45	29.73	0.05	0.01	0.02	0.01	0.50
1994	0.55	38.86	0.05	0.01	0.02	0.01	0.50
1995	0.69	13.97	7.26	2.29	6.37	2.01	0.90
1996	0.46	35.81	80.19	25.26	69.86	22.01	0.90
1997	0.83	25.99	0.04	0.01	0.04	0.01	0.80
1998	0.55	12.66	0.05	0.01	0.04	0.01	0.90
1999	0.44	26.44	29.08	9.16	38.51	12.13	1.30
2000	0.62	66.17	6.53	2.06	6.18	1.95	0.90
2001	0.83	5.73	0.04	0.01	0.04	0.01	0.90
2002	0.83	6.87	14.84	4.67	14.45	4.55	1.00
2003	0.65	2.07	3.54	1.12	3.56	1.12	1.00
2004	0.67	25.30	12.53	3.95	11.95	3.77	1.00
2005	0.46	92.92	171.41	53.99	166.54	52.46	1.00
2006	0.51	30.94	46.15	14.54	42.23	13.30	0.90
2007	0.49	43.27	85.63	26.97	161.42	50.85	1.90
2008	0.57	4.08	7.76	2.44	16.98	5.35	2.20
2009	0.61	51.47	20.77	6.54	68.38	21.54	3.30
2010	0.52	24.25	3.71	1.17	14.41	4.54	3.90
2011	0.82	8.01	14.98	4.72	57.60	18.14	3.80

**Table 61 Continued.** Input (with log-scale standard errors, SE) and expected (Exp) discards for the Recreational Private East fleet in number (N, 1,000s of fish) and biomass (B, thousand pounds whole weight) for Gulf of Mexico Red Snapper. Dead discards in numbers (discard mortality rate = 0.315), dead discards in biomass, and mean weight (MW, whole pounds per fish) are included. Mean weight was determined by dividing the expected discards in weights by the expected discards in numbers.

Year	Input N SE	Input N	Exp N	Exp Dead N	Exp B	Exp Dead B	MW
2012	0.83	3.69	13.92	4.38	53.02	16.70	3.80
2013	0.46	3.03	3.20	1.01	13.95	4.39	4.40
2014	0.55	6.50	7.05	2.22	20.20	6.37	2.90
2015	0.58	3.80	5.12	1.61	8.81	2.77	1.70
2016	0.60	38.49	58.82	18.53	114.43	36.05	1.90
2017	0.33	61.76	96.37	30.36	247.06	77.83	2.60
2018	0.38	123.73	94.41	29.74	334.59	105.40	3.50
2019	0.35	61.01	82.45	25.97	325.93	102.67	4.00

**Table 62.** Input (with log-scale standard errors, SE) and expected (Exp) discards for the Recreational Private Closed Season Discards West fleet in number (N, 1,000s of fish) and biomass (B, thousand pounds whole weight) for Gulf of Mexico Red Snapper. Dead discards in numbers (discard mortality rate = 0.211), dead discards in biomass, and mean weight (MW, whole pounds per fish) are included. Mean weight was determined by dividing the expected discards in weights by the expected discards in numbers.

Year	Input N SE	Input N	Exp N	Exp Dead N	Exp B	Exp Dead B	MW
1997	0.48	10.63	10.62	2.24	24.42	5.15	2.30
1998	0.50	51.69	51.47	10.86	122.52	25.85	2.40
1999	0.39	250.97	247.73	52.27	561.78	118.53	2.30
2000	0.39	183.00	183.48	38.72	405.03	85.46	2.20
2001	0.47	112.14	112.40	23.72	259.35	54.72	2.30
2002	0.66	144.24	145.52	30.70	348.04	73.44	2.40
2003	0.61	404.23	446.40	94.19	1,022.29	215.70	2.30
2004	0.75	539.52	662.12	139.71	1,396.00	294.56	2.10
2005	0.55	444.25	501.63	105.84	1,007.87	212.66	2.00
2006	0.40	470.84	501.91	105.90	996.71	210.31	2.00
2007	0.36	300.11	305.19	64.40	640.41	135.13	2.10
2008	0.48	1,042.73	1,062.49	224.19	2,935.65	619.42	2.80
2009	0.43	608.94	619.49	130.71	1,771.26	373.74	2.90
2010	0.87	692.12	662.43	139.77	2,070.39	436.85	3.10
2011	0.55	981.43	990.36	208.97	3,347.87	706.40	3.40
2012	0.46	506.70	514.20	108.50	1,718.10	362.52	3.30
2013	0.45	547.57	538.54	113.63	1,922.57	405.66	3.60
2014	0.32	87.80	87.55	18.47	333.98	70.47	3.80
2015	0.32	143.82	143.33	30.24	530.27	111.89	3.70
2016	0.32	19.68	19.68	4.15	74.75	15.77	3.80

**Table 63.** Input (with log-scale standard errors, SE) and expected (Exp) discards for the Recreational Private Closed Season Discards Central fleet in number (N, 1,000s of fish) and biomass (B, thousand pounds whole weight) for Gulf of Mexico Red Snapper. Dead discards in numbers (discard mortality rate = 0.297), dead discards in biomass, and mean weight (MW, whole pounds per fish) are included. Mean weight was determined by dividing the expected discards in weights by the expected discards in numbers.

Year	Input N SE	Input N	Exp N	Exp Dead N	Exp B	Exp Dead B	MW
1997	0.25	243.97	241.67	71.78	340.67	101.18	1.40
1998	0.22	281.52	279.94	83.14	440.89	130.94	1.60
1999	0.22	371.64	370.25	109.96	722.22	214.50	2.00
2000	0.23	1,245.76	1,292.48	383.87	2,423.08	719.65	1.90
2001	0.19	2,698.90	2,625.39	779.74	4,622.52	1,372.88	1.80
2002	0.22	3,136.65	3,067.59	911.08	5,460.78	1,621.85	1.80
2003	0.20	1,924.07	1,934.68	574.60	3,387.02	1,005.95	1.80
2004	0.19	1,089.85	1,110.62	329.85	1,831.27	543.89	1.60
2005	0.18	1,639.57	1,744.38	518.08	2,925.31	868.82	1.70
2006	0.16	1,280.18	1,308.91	388.75	1,843.22	547.44	1.40
2007	0.16	1,549.03	1,590.73	472.45	2,746.03	815.57	1.70
2008	0.21	3,426.38	3,539.36	1,051.19	8,605.76	2,555.90	2.40
2009	0.17	2,339.13	2,297.21	682.27	7,138.80	2,120.22	3.10
2010	0.19	3,401.43	3,673.36	1,090.99	12,708.80	3,774.51	3.50
2011	0.17	2,847.78	3,195.68	949.12	12,987.61	3,857.31	4.10
2012	0.16	3,286.85	3,611.79	1,072.70	14,532.61	4,316.18	4.00
2013	0.29	3,230.27	2,818.79	837.18	11,042.35	3,279.57	3.90
2014	0.22	3,411.62	3,018.37	896.46	11,642.69	3,457.88	3.90
2015	0.19	2,127.99	1,975.29	586.66	6,818.89	2,025.21	3.50
2016	0.17	3,949.25	3,358.92	997.60	10,529.57	3,127.28	3.10
2017	0.17	5,539.61	5,303.41	1,575.11	16,873.76	5,011.50	3.20
2018	0.19	3,972.81	3,590.33	1,066.33	12,067.52	3,584.05	3.40
2019	0.17	4,577.79	4,703.63	1,396.98	16,976.12	5,041.92	3.60



**Table 64.** Input (with log-scale standard errors, SE) and expected (Exp) discards for the Recreational Private Closed Season Discards East fleet in number (N, 1,000s of fish) and biomass (B, thousand pounds whole weight) for Gulf of Mexico Red Snapper. Dead discards in numbers (discard mortality rate = 0.315), dead discards in biomass, and mean weight (MW, whole pounds per fish) are included. Mean weight was determined by dividing the expected discards in weights by the expected discards in numbers.

Year	Input N SE	Input N	Exp N	Exp Dead N	Exp B	Exp Dead B	MW
1998	0.55	52.95	54.09	17.04	95.77	30.17	1.80
1999	0.44	23.42	23.70	7.47	59.44	18.73	2.50
2000	0.62	1.56	1.56	0.49	3.81	1.20	2.40
2003	0.65	2.92	2.93	0.92	8.40	2.65	2.90
2004	0.67	67.29	70.99	22.36	202.17	63.69	2.80
2005	0.46	36.26	36.67	11.55	106.09	33.42	2.90
2006	0.51	24.38	24.48	7.71	54.99	17.32	2.20
2008	0.57	36.40	37.00	11.65	126.82	39.95	3.40
2009	0.61	51.36	52.56	16.56	232.93	73.37	4.40
2010	0.52	105.22	107.39	33.83	541.47	170.56	5.00
2011	0.82	1,492.56	2,084.43	656.60	11,174.07	3,519.83	5.40
2012	0.83	10.60	10.68	3.36	58.79	18.52	5.50
2013	0.46	5.49	5.49	1.73	32.81	10.34	6.00
2014	0.55	42.88	42.92	13.52	209.14	65.88	4.90
2015	0.58	20.21	20.20	6.36	66.33	20.89	3.30
2016	0.60	669.67	744.46	234.50	2,455.11	773.36	3.30
2017	0.33	198.97	201.34	63.42	753.81	237.45	3.70
2018	0.38	523.31	541.69	170.63	2,462.58	775.72	4.50
2019	0.35	334.14	338.68	106.68	1,730.82	545.21	5.10

**Table 65.** Input (with log-scale standard errors, SE) and expected (Exp) discards for the Recreational Charter Closed Season Discards West fleet in number (N, 1,000s of fish) and biomass (B, thousand pounds whole weight) for Gulf of Mexico Red Snapper. Dead discards in numbers (discard mortality rate = 0.262), dead discards in biomass, and mean weight (MW, whole pounds per fish) are included. Mean weight was determined by dividing the expected discards in weights by the expected discards in numbers.

Year	Input N SE	Input N	Exp N	Exp Dead N	Exp B	Exp Dead B	MW
1997	0.32	0.40	0.40	0.10	0.98	0.26	2.50
1998	0.46	0.62	0.62	0.16	1.61	0.42	2.60
1999	0.50	0.56	0.56	0.15	1.35	0.35	2.40
2000	0.33	1.53	1.53	0.40	3.65	0.96	2.40
2002	0.35	1.14	1.14	0.30	2.96	0.78	2.60
2003	0.28	3.54	3.54	0.93	8.71	2.28	2.50
2004	0.30	1.38	1.38	0.36	3.10	0.81	2.20
2005	0.31	30.36	30.44	7.97	64.88	17.00	2.10
2006	0.26	13.50	13.51	3.54	28.33	7.42	2.10
2007	0.22	4.11	4.11	1.08	14.85	3.89	3.60
2008	0.24	28.55	28.52	7.47	119.16	31.22	4.20
2009	0.09	19.25	19.25	5.04	88.56	23.20	4.60
2010	0.06	2.65	2.65	0.69	12.94	3.39	4.90
2011	0.05	2.82	2.82	0.74	15.06	3.94	5.30
2012	0.09	11.46	11.46	3.00	62.59	16.40	5.50
2013	0.05	16.23	16.23	4.25	92.18	24.15	5.70
2014	0.05	3.36	3.36	0.88	20.14	5.28	6.00
2015	0.05	9.33	9.33	2.44	56.40	14.78	6.00
2016	0.05	6.45	6.45	1.69	39.60	10.38	6.10
2017	0.07	5.32	5.32	1.40	34.22	8.97	6.40
2018	0.05	3.95	3.95	1.04	25.65	6.72	6.50
2019	0.06	18.10	18.10	4.74	117.41	30.76	6.50

**Table 66.** Input (with log-scale standard errors, SE) and expected (Exp) discards for the Recreational Charter Closed Season Discards West fleet in number (N, 1,000s of fish) and biomass (B, thousand pounds whole weight) for Gulf of Mexico Red Snapper. Dead discards in numbers (discard mortality rate = 0.211), dead discards in biomass, and mean weight (MW, whole pounds per fish) are included. Mean weight was determined by dividing the expected discards in weights by the expected discards in numbers.

Year	Input N SE	Input N	Exp N	Exp Dead N	Exp B	Exp Dead B	MW
1997	0.25	14.87	14.85	2.51	43.30	7.32	2.90
1998	0.11	88.15	88.08	14.88	262.70	44.40	3.00
1999	0.09	143.26	143.19	24.20	466.35	78.81	3.30
2000	0.08	135.40	135.44	22.89	464.58	78.52	3.40
2001	0.10	99.10	99.03	16.74	337.88	57.10	3.40
2002	0.09	90.03	90.00	15.21	300.15	50.73	3.30
2003	0.09	75.09	75.08	12.69	244.67	41.35	3.30
2004	0.09	82.52	82.55	13.95	262.48	44.36	3.20
2005	0.09	87.76	87.82	14.84	266.50	45.04	3.00
2006	0.11	151.70	151.97	25.68	440.98	74.53	2.90
2007	0.11	103.57	103.66	17.52	349.19	59.01	3.40
2008	0.09	319.82	320.02	54.08	1,170.93	197.89	3.70
2009	0.05	262.25	262.21	44.31	1,083.75	183.15	4.10
2010	0.06	170.75	170.78	28.86	796.63	134.63	4.70
2011	0.05	276.19	276.34	46.70	1,418.87	239.79	5.10
2012	0.08	193.05	193.23	32.66	1,054.69	178.24	5.50
2013	0.05	324.96	324.83	54.90	1,835.75	310.24	5.70
2014	0.05	269.32	269.18	45.49	1,505.30	254.40	5.60
2015	0.05	195.17	195.08	32.97	1,072.45	181.24	5.50
2016	0.05	299.90	299.55	50.62	1,587.24	268.24	5.30
2017	0.05	353.69	353.62	59.76	1,755.94	296.75	5.00
2018	0.05	293.57	293.43	49.59	1,406.73	237.74	4.80
2019	0.05	338.37	338.42	57.19	1,676.07	283.25	5.00

**Table 67.** Input (with log-scale standard errors, SE) and expected (Exp) discards for the Recreational Charter Closed Season Discards Central fleet in number (N, 1,000s of fish) and biomass (B, thousand pounds whole weight) for Gulf of Mexico Red Snapper. Dead discards in numbers (discard mortality rate = 0.169), dead discards in biomass, and mean weight (MW, whole pounds per fish) are included. Mean weight was determined by dividing the expected discards in weights by the expected discards in numbers.

Year	Input N SE	Input N	Exp N	Exp Dead N	Exp B	Exp Dead B	MW
1997	0.83	0.31	0.31	0.08	1.22	0.33	3.90
1998	0.50	0.18	0.18	0.05	0.70	0.19	3.80
2000	0.66	0.09	0.09	0.02	0.39	0.10	4.40
2001	0.65	2.68	2.94	0.79	13.43	3.60	4.60
2003	0.77	2.58	2.72	0.73	13.06	3.50	4.80
2004	0.50	0.69	0.70	0.19	3.55	0.95	5.10
2005	0.56	1.04	1.05	0.28	5.42	1.45	5.10
2006	0.50	9.69	10.12	2.71	49.23	13.19	4.90
2007	0.58	2.00	2.03	0.54	10.20	2.73	5.00
2008	0.07	13.72	13.74	3.68	68.63	18.39	5.00
2009	0.06	12.78	12.79	3.43	66.78	17.90	5.20
2010	0.10	2.24	2.24	0.60	12.93	3.46	5.80
2011	0.06	1.95	1.95	0.52	12.73	3.41	6.50
2012	0.05	0.72	0.72	0.19	4.98	1.33	6.90
2013	0.05	6.32	6.32	1.69	44.95	12.05	7.10
2014	0.05	7.95	7.95	2.13	57.47	15.40	7.20
2015	0.05	9.62	9.62	2.58	68.43	18.34	7.10
2016	0.05	36.88	36.90	9.89	206.65	55.38	5.60
2017	0.05	145.53	145.93	39.11	712.95	191.07	4.90
2018	0.05	43.09	43.12	11.55	221.65	59.40	5.10
2019	0.05	15.55	15.55	4.17	90.64	24.29	5.80

**Table 68.** Observed (Obs) versus predicted (Exp) standardized SEAMAP Fall Trawl Pre-2007 West index and associated lognormal standard error (as estimated by the standardization process) for Gulf of Mexico Red Snapper. Values are normalized to the mean. CVs as estimated by the standardization process were converted to log-scale SEs.

Year	SEAMAP Video (Obs)	SEAMAP Video (Exp)	SEAMAP Video (SE)
1988	0.43	0.43	0.23
1989	0.86	1.25	0.22
1990	0.91	1.07	0.19
1991	1.03	0.93	0.18
1992	0.32	0.57	0.24
1993	0.57	0.71	0.22
1994	1.63	1.22	0.19
1995	1.75	1.11	0.17
1996	0.87	0.93	0.20
1997	1.29	0.85	0.20
1998	0.60	0.77	0.22
1999	1.37	1.08	0.18
2000	0.91	0.95	0.18
2001	0.68	0.77	0.21
2002	0.65	0.75	0.21
2003	1.15	1.03	0.19
2004	1.80	1.25	0.17
2005	1.27	1.35	0.16
2006	1.08	1.40	0.19
2007	0.84	1.30	0.22

**Table 69.** Observed (Obs) versus predicted (Exp) standardized SEAMAP Fall Trawl Pre-2007 West index and associated lognormal standard error (as estimated by the standardization process) for Gulf of Mexico Red Snapper. Values are normalized to the mean. CVs as estimated by the standardization process were converted to log-scale SEs.

Year	SEAMAP Video (Obs)	SEAMAP Video (Exp)	SEAMAP Video (SE)
2008	0.45	0.41	0.15
2009	1.47	1.22	0.14
2010	0.69	0.73	0.20
2011	0.82	1.00	0.19
2012	1.58	1.27	0.19
2013	0.66	0.88	0.28
2014	0.90	0.92	0.20
2015	1.65	1.38	0.18
2016	1.11	1.06	0.23
2017	0.76	0.88	0.22
2018	1.08	1.36	0.19
2019	0.84	1.08	0.23

**Table 70.** Observed (Obs) versus predicted (Exp) standardized SEAMAP Fall Trawl Pre-2007 West index and associated lognormal standard error (as estimated by the standardization process) for Gulf of Mexico Red Snapper. Values are normalized to the mean. CVs as estimated by the standardization process were converted to log-scale SEs.

Year	Combined Video (Obs)	Combined Video (Exp)	Combined Video (SE)
2008	0.60	0.48	0.22
2009	2.28	1.25	0.13
2010	0.69	0.68	0.19
2011	0.57	0.57	0.23
2012	1.37	1.15	0.19
2013	0.70	0.70	0.22
2014	0.98	1.14	0.19
2015	1.29	1.63	0.18
2016	0.98	1.93	0.27
2017	0.56	1.05	0.18
2018	1.27	1.45	0.18
2019	0.69	0.89	0.22

**Table 71.** Observed (Obs) versus predicted (Exp) standardized SEAMAP Fall Trawl Pre-2007 West index and associated lognormal standard error (as estimated by the standardization process) for Gulf of Mexico Red Snapper. Values are normalized to the mean. CVs as estimated by the standardization process were converted to log-scale SEs.

Year	Combined Video (Obs)	Combined Video (Exp)	Combined Video (SE)
2008	0.67	0.62	0.29
2009	0.41	0.36	0.21
2010	0.72	0.47	0.17
2012	0.93	0.38	0.29
2013	0.17	0.25	0.29
2014	3.26	1.70	0.14
2015	1.25	2.20	0.12
2016	1.60	1.70	0.17
2017	0.86	0.98	0.15
2018	0.34	0.56	0.22
2019	0.78	0.82	0.16



**Table 72.** Observed (Obs) versus predicted (Exp) standardized SEAMAP Summer Trawl Pre-2007 West index and associated lognormal standard error (as estimated by the standardization process) for Gulf of Mexico Red Snapper. Values are normalized to the mean. CVs as estimated by the standardization process were converted to log-scale SEs.

Year	SEAMAP Video (Obs)	SEAMAP Video (Exp)	SEAMAP Video (SE)
1984	0.75	0.80	0.27
1985	1.11	0.73	0.29
1986	0.29	0.64	0.41
1987	0.71	0.65	0.21
1988	0.35	0.49	0.24
1989	0.26	0.79	0.29
1990	2.26	1.34	0.15
1991	1.02	1.08	0.18
1992	0.64	0.85	0.19
1993	0.70	0.66	0.19
1994	1.35	1.01	0.17
1995	1.18	1.36	0.16
1996	1.31	1.12	0.16
1997	0.99	0.92	0.17
1998	0.89	0.85	0.18
1999	0.76	0.96	0.19
2000	1.39	1.14	0.15
2001	0.79	0.92	0.25
2002	1.09	0.79	0.16
2003	0.61	0.90	0.20
2004	1.33	1.19	0.16
2005	1.50	1.42	0.16
2006	1.42	1.57	0.14

**Table 73.** Observed (Obs) versus predicted (Exp) standardized SEAMAP Summer Trawl Post-2007 West index and associated lognormal standard error (as estimated by the standardization process) for Gulf of Mexico Red Snapper. Values are normalized to the mean. CVs as estimated by the standardization process were converted to log-scale SEs.

Year	SEAMAP Video (Obs)	SEAMAP Video (Exp)	SEAMAP Video (SE)
2009	0.37	0.67	0.20
2010	0.87	0.93	0.20
2011	1.21	0.79	0.19
2012	0.84	1.01	0.19
2013	1.31	1.05	0.22
2014	0.79	0.86	0.21
2015	1.09	1.00	0.20
2016	0.89	1.14	0.20
2017	0.85	0.95	0.21
2018	1.64	1.00	0.18
2019	1.14	1.17	0.20

**Table 74.** Observed (Obs) versus predicted (Exp) standardized SEAMAP Summer Trawl Post-2007 Central index and associated lognormal standard error (as estimated by the standardization process) for Gulf of Mexico Red Snapper. Values are normalized to the mean. CVs as estimated by the standardization process were converted to log-scale SEs.

Year	Combined Video (Obs)	Combined Video (Exp)	Combined Video (SE)
2009	0.45	0.70	0.18
2010	1.01	0.92	0.20
2011	0.57	0.61	0.24
2012	1.08	0.67	0.20
2013	1.37	0.85	0.22
2014	0.68	0.75	0.20
2015	0.65	1.09	0.22
2016	0.95	1.45	0.19
2017	1.67	1.42	0.15
2018	1.14	1.07	0.20
2019	1.42	1.11	0.19

**Table 75.** Observed (Obs) versus predicted (Exp) standardized SEAMAP Summer Trawl Post-2007 East index and associated lognormal standard error (as estimated by the standardization process) for Gulf of Mexico Red Snapper. Values are normalized to the mean. CVs as estimated by the standardization process were converted to log-scale SEs.

Year	Combined Video (Obs)	Combined Video (Exp)	Combined Video (SE)
2009	0.10	0.50	0.30
2010	0.03	0.43	0.38
2011	1.17	0.53	0.18
2012	0.56	0.47	0.16
2013	0.17	0.41	0.30
2014	0.38	0.53	0.16
2015	3.36	2.52	0.13
2016	2.03	2.20	0.11
2017	1.49	1.57	0.14
2018	1.18	0.78	0.13
2019	0.53	0.67	0.20

**Table 76.** Observed (Obs) versus predicted (Exp) standardized SEAMAP Larval Survey West index and associated lognormal standard error (as estimated by the standardization process) for Gulf of Mexico Red Snapper. Values are normalized to the mean. CVs as estimated by the standardization process were converted to log-scale SEs.

Year	SEAMAP Video (Obs)	SEAMAP Video (Exp)	SEAMAP Video (SE)
1986	0.28	0.38	0.30
1987	0.44	0.33	0.30
1989	0.55	0.30	0.29
1990	0.45	0.32	0.25
1991	0.21	0.37	0.33
1992	0.25	0.46	0.23
1993	0.27	0.52	0.23
1994	0.20	0.55	0.30
1995	0.76	0.57	0.17
1996	0.53	0.61	0.21
1997	0.89	0.66	0.16
1999	0.38	0.64	0.22
2000	1.22	0.63	0.16
2001	0.85	0.62	0.23
2002	0.64	0.63	0.18
2003	1.21	0.62	0.15
2004	0.68	0.61	0.18
2006	1.19	0.61	0.18
2007	1.05	0.65	0.15
2009	1.28	1.01	0.15
2010	0.52	1.26	0.22
2011	2.10	1.48	0.17
2012	1.98	1.71	0.15

**Table 77.** Observed (Obs) versus predicted (Exp) standardized SEAMAP Larval Survey Central index and associated lognormal standard error (as estimated by the standardization process) for Gulf of Mexico Red Snapper. Values are normalized to the mean. CVs as estimated by the standardization process were converted to log-scale SEs.

Year	Combined Video (Obs)	Combined Video (Exp)	Combined Video (SE)
1991	0.12	0.19	0.29
1994	0.03	0.19	0.30
1995	0.06	0.16	0.30
1997	0.09	0.23	0.29
1999	0.37	0.39	0.20
2000	0.80	0.41	0.18
2001	0.15	0.44	0.20
2003	0.40	0.40	0.18
2004	0.16	0.40	0.30
2006	0.61	0.46	0.20
2007	0.89	0.68	0.15
2008	0.09	0.93	0.29
2009	0.51	1.34	0.20
2010	2.72	1.66	0.12
2011	0.91	1.77	0.20
2012	0.79	1.72	0.16
2013	0.85	1.67	0.16
2014	1.48	1.49	0.16
2015	0.47	1.61	0.30
2016	1.03	1.73	0.13
2017	4.26	1.88	0.09
2018	1.80	1.80	0.12
2019	4.41	2.10	0.10

**Table 78.** Observed (Obs) versus predicted (Exp) standardized SEAMAP Reef Fish Video Survey West index and associated lognormal standard error (as estimated by the standardization process) for Gulf of Mexico Red Snapper. Values are normalized to the mean. CVs as estimated by the standardization process were converted to log-scale SEs.

Year	SEAMAP Video (Obs)	SEAMAP Video (Exp)	SEAMAP Video (SE)
1993	0.14	0.63	0.16
1994	0.34	0.62	0.18
1995	0.31	0.72	0.21
1996	0.70	0.78	0.20
1997	1.55	0.76	0.21
2002	1.08	0.66	0.22
2004	0.95	0.64	0.17
2005	0.96	0.70	0.20
2006	0.38	0.81	0.22
2007	1.02	0.98	0.17
2008	0.72	1.19	0.19
2009	1.08	1.26	0.24
2010	2.24	1.49	0.20
2011	1.74	1.57	0.24
2012	1.87	1.72	0.20
2013	2.62	1.90	0.21
2014	3.49	1.99	0.17
2015	2.14	2.06	0.20
2016	2.64	2.20	0.23
2017	3.04	2.28	0.21
2018	6.04	2.34	0.20
2019	3.34	2.47	0.18

**Table 79.** Observed (Obs) versus predicted (Exp) standardized Combined Video Survey Central index and associated lognormal standard error (as estimated by the standardization process) for Gulf of Mexico Red Snapper. Values are normalized to the mean. CVs as estimated by the standardization process were converted to log-scale SEs.

Year	Combined Video (Obs)	Combined Video (Exp)	Combined Video (SE)
1993	0.10	0.25	0.43
1994	0.09	0.18	0.52
1995	0.05	0.21	0.72
1996	0.14	0.24	0.35
1997	0.27	0.39	0.27
2002	0.62	0.53	0.21
2004	1.22	0.50	0.16
2005	1.00	0.51	0.14
2006	0.99	0.86	0.15
2007	1.60	1.12	0.15
2008	1.42	1.44	0.12
2009	1.86	1.41	0.11
2010	1.69	1.49	0.10
2011	1.63	1.33	0.09
2012	0.87	1.18	0.11
2013	1.07	1.17	0.13
2014	0.98	1.12	0.15
2015	0.80	1.26	0.11
2016	1.41	1.49	0.08
2017	1.54	1.67	0.09
2018	1.11	1.65	0.13
2019	1.54	1.75	0.09



**Table 80.** Observed (Obs) versus predicted (Exp) standardized Combined Video Survey East index and associated lognormal standard error (as estimated by the standardization process) for Gulf of Mexico Red Snapper. Values are normalized to the mean. CVs as estimated by the standardization process were converted to log-scale SEs.

Year	Combined Video (Obs)	Combined Video (Exp)	Combined Video (SE)
2010	0.46	0.72	0.26
2011	0.60	0.59	0.18
2012	0.31	0.50	0.18
2013	0.69	0.51	0.24
2014	0.39	0.47	0.18
2015	1.51	1.10	0.32
2016	2.04	1.45	0.13
2017	1.46	1.58	0.15
2018	1.45	1.38	0.16
2019	1.09	1.15	0.21

**Table 81.** Observed (Obs) versus predicted (Exp) standardized fishery-dependent catch-per-unit-effort (CPUE) indices for Eastern Gulf of Mexico Red Snapper . Values are normalized to the mean. CVs estimated by the standardization process were scaled to have a mean equal to the minimum CV from the SEAMAP index and converted to log-scale SEs.

Yr	HL (Obs)	HL (Exp)	HL (SE)	Comm RF (Obs)	Comm RF (Exp)	Comm RF (SE)
1993	0.30	0.22	0.26			
1994	0.11	0.27	0.34			
1995	0.25	0.33	0.23			
1996	0.24	0.32	0.21			
1997	0.38	0.32	0.20			
1998	0.26	0.46	0.24			
1999	1.02	0.59	0.20			
2000	1.59	0.73	0.16			
2001	1.10	0.95	0.19			
2002	0.95	1.28	0.18			
2003	1.22	1.72	0.15			
2004	2.07	2.18	0.14			
2005	1.86	2.33	0.15			
2006	2.64	2.37	0.13			
2007				0.40	0.42	0.22
2008				0.48	0.61	0.21
2009				0.82	0.85	0.21
2010				0.84	1.09	0.15
2011				0.85	0.93	0.11
2012				0.70	0.76	0.08
2013				0.75	0.81	0.12
2014				0.84	0.84	0.17
2015				0.91	0.84	0.28

**Table 81 Continued.** Observed (Obs) versus predicted (Exp) standardized fishery-dependent catch-per-unit-effort (CPUE) indices for Eastern Gulf of Mexico Red Snapper . Values are normalized to the mean. CVs estimated by the standardization process were scaled to have a mean equal to the minimum CV from the SEAMAP index and converted to log-scale SEs.

Yr	HL (Obs)	HL (Exp)	HL (SE)	Comm RF (Obs)	Comm RF (Exp)	Comm RF (SE)
2016				2.03	0.96	0.13
2017				1.49	1.31	0.41
2018				1.75	1.66	0.21
2019				1.15	1.81	0.30

**Table 82.** Observed (Obs) versus predicted (Exp) standardized Bottom Longline West and Red Snapper Count West indices and associated lognormal standard error (as estimated by the standardization process) for Western Gulf of Mexico Red Snapper. Values are normalized to the mean. CVs as estimated by the standardization process were converted to log-scale SEs.

Year	Bottom Longline (Obs)	Bottom Longline (Exp)	Bottom Longline (SE)	RSC (Obs)	RSC (Exp)	RSC (SE)
2001	0.32	0.33	0.19			
2002	0.25	0.32	0.17			
2003	0.29	0.31	0.21			
2004	0.34	0.31	0.21			
2006	0.28	0.28	0.26			
2007	0.30	0.27	0.26			
2009	0.51	0.44	0.19			
2010	0.25	0.65	0.33			
2011	0.71	0.92	0.14			
2012	1.24	1.18	0.21			
2013	1.14	1.34	0.19			
2014	0.86	1.41	0.23			
2015	2.12	1.52	0.17			
2016	1.76	1.64	0.17			
2017	2.70	1.79	0.12			
2018	1.56	1.94	0.17	30824.00	23049.10	0.27
2019	2.36	2.01	0.17			

**Table 83.** Observed (Obs) versus predicted (Exp) standardized Bottom Longline Central and Red Snapper Count Central indices and associated lognormal standard error (as estimated by the standardization process) for Western Gulf of Mexico Red Snapper. Values are normalized to the mean. CVs as estimated by the standardization process were converted to log-scale SEs.

Year	Bottom Longline (Obs)	Bottom Longline (Exp)	Bottom Longline (SE)	RSC (Obs)	RSC (Exp)	RSC (SE)
2001	0.17	0.16	0.24			
2002	0.12	0.16	0.24			
2003	0.27	0.13	0.21			
2004	0.11	0.11	0.30			
2005	0.09	0.11	0.30			
2006	0.17	0.14	0.31			
2009	0.37	0.52	0.21			
2010	1.26	0.89	0.15			
2011	1.69	1.37	0.09			
2012	1.16	1.81	0.21			
2013	0.55	1.98	0.21			
2014	2.08	1.98	0.14			
2015	2.39	2.02	0.13			
2016	2.56	2.00	0.14			
2017	0.89	1.75	0.17			
2018	1.20	1.63	0.17	30806.00	15868.50	0.22
2019	1.92	1.74	0.18			

**Table 84.** Observed (Obs) versus predicted (Exp) standardized Bottom Longline East and Red Snapper Count East indices and associated lognormal standard error (as estimated by the standardization process) for Western Gulf of Mexico Red Snapper. Values are normalized to the mean. CVs as estimated by the standardization process were converted to log-scale SEs.

Year	Bottom Longline (Obs)	Bottom Longline (Exp)	Bottom Longline (SE)	RSC (Obs)	RSC (Exp)	RSC (SE)
2001	0.12	0.19	0.26			
2003	0.43	0.30	0.20			
2004	0.69	0.40	0.17			
2005	0.53	0.46	0.26			
2006	0.26	0.44	0.26			
2007	1.74	0.49	0.20			
2009	1.16	1.00	0.15			
2010	1.85	1.52	0.13			
2011	1.77	1.47	0.09			
2012	0.48	1.31	0.20			
2013	2.85	1.28	0.26			
2014	0.36	1.26	0.26			
2016	1.68	1.24	0.17			
2017	0.65	1.16	0.20			
2018	0.51	1.57	0.20	24707.00	2862.70	0.22
2019	0.93	2.65	0.20			

**Table 85.** Summary of correlated parameters with correlation coefficients > 0.7 for Gulf of Mexico Red Snapper from the SEDAR 74 base model.

Parameter 1	Parameter 2	Correlation
Size_DblN_descend_se HBT_C(17)_BLK5repl_1995	Size_DblN_top_logit HBT_C(17)_BLK5repl_1995	-0.943
Size_DblN_top_logit_PRIV_C(20)	Size_DblN_peak_PRIV_C(20)	-0.896
Size_DblN_descend_se HL_W(1)_BLK4repl_2007	Size_DblN_top_logit HL_W(1)_BLK4repl_2007	-0.874
Size_DblN_top_logit_CBT_W(14)	Size_DblN_peak_CBT_W(14)	-0.865
Size_DblN_descend_se HL_E(3)_BLK4repl_2007	Size_DblN_top_logit HL_E(3)_BLK4repl_2007	-0.857
Size_DblN_descend_se_HL_W(1)	InitF_seas_1_ft_1HL_W	-0.852
InitF_seas_1_ft_16HBT_W	SR_LN(R0)	-0.844
Size_DblN_ascend_se_CBT_W(14)	Size_DblN_top_logit_CBT_W(14)	-0.839
Size_DblN_descend_se HBT_W(16)_BLK5repl_1995	Size_DblN_top_logit HBT_W(16)_BLK5repl_1995	-0.836
Size_DblN_top_logit_CBT_W(14)_BLK5repl_1995	Size_DblN_peak_CBT_W(14)_BLK5repl_1995	-0.835
Size_DblN_end_logit_CBT_W(14)	InitF_seas_1_ft_14CBT_W	-0.834
Size_DblN_descend_se HBT_C(17)_BLK5repl_2007	Size_DblN_top_logit HBT_C(17)_BLK5repl_2007	-0.831
Size_DblN_top_logit_HBT_W(16)	Size_DblN_peak_HBT_W(16)	-0.828
Size_DblN_descend_se HBT_W(16)_BLK5repl_2007	Size_DblN_top_logit HBT_W(16)_BLK5repl_2007	-0.821
Size_DblN_top_logit_PRIV_W(19)_BLK5repl_1995	Size_DblN_peak_PRIV_W(19)_BLK5repl_1995	-0.815
SR_LN(R0)	RecrDist_GP_1_area_1_month_7	-0.813
Size_DblN_ascend_se_CBT_W(14)_BLK5repl_1995	Size_DblN_top_logit_CBT_W(14)_BLK5repl_1995	-0.805
Size_DblN_end_logit_PRIV_W(19)	InitF_seas_1_ft_19PRIV_W	-0.793

**Table 85 Continued.** Summary of correlated parameters with correlation coefficients > 0.7 for Gulf of Mexico Red Snapper from the SEDAR 74 base model.

Parameter 1	Parameter 2	Correlation
Size_DblN_ascend_se_PRIV_W(19)_BLK5repl_1995	Size_DblN_top_logit_PRIV_W(19)_BLK5repl_1995	-0.783
Size_DblN_ascend_se_HBT_W(16)	Size_DblN_top_logit_HBT_W(16)	-0.779
InitF_seas_1_flt_19PRIV_W	SR_LN(R0)	-0.766
Size_DblN_top_logit_PRIV_W(19)	Size_DblN_peak_PRIV_W(19)	-0.749
Size_DblN_descend_se_PRIV_W(19)_BLK5repl_2007	Size_DblN_top_logit_PRIV_W(19)_BLK5repl_2007	-0.738
Size_DblN_descend_se_HL_W(1)_BLK4repl_1993	Size_DblN_top_logit_HL_W(1)_BLK4repl_1993	-0.729
Retain_L_width_PRIV_W(19)_BLK2repl_2000	Size_DblN_start_logit_PRIV_W(19)_BLK5repl_2007	-0.718
Size_DblN_end_logit_HBT_C(17)	InitF_seas_1_flt_17HBT_C	-0.717
AgeSel_P3_FALLATE_C(29)	AgeSel_P2_FALLATE_C(29)	-0.706
InitF_seas_1_flt_15CBT_E	InitF_seas_1_flt_3HL_E	0.702
InitF_seas_1_flt_19PRIV_W	InitF_seas_1_flt_16HBT_W	0.705
Size_95%width_SEAVID_W(4)	Size_inflection_SEAVID_W(4)	0.727
Size_95%width_LL_W(7)_BLK4repl_2007	Size_inflection_LL_W(7)_BLK4repl_2007	0.728
Size_95%width_GFISHER_C(5)_BLK6repl_2006	Size_inflection_GFISHER_C(5)_BLK6repl_2006	0.730
InitF_seas_1_flt_16HBT_W	RecrDist_GP_1_area_1_month_7	0.747
Age_DblN_ascend_se_GRSC_W(48)	Age_DblN_peak_GRSC_W(48)	0.753
Size_DblN_ascend_se_CBT_W(14)_BLK5repl_2007	Size_DblN_peak_CBT_W(14)_BLK5repl_2007	0.758
Age_95%width_BLL_W(10)	Age_inflection_BLL_W(10)	0.800



**Table 85 Continued.** Summary of correlated parameters with correlation coefficients > 0.7 for Gulf of Mexico Red Snapper from the SEDAR 74 base model.

Parameter 1	Parameter 2	Correlation
Retain_L_asymptote_logit_PRIV_W(19)_BLK3repl_2007	Size_DblN_start_logit_PRIV_W(19)_BLK5repl_2007	0.803
Size_95%width_LL_E(8)	Size_inflection_LL_E(8)	0.804
Size_DblN_ascend_se_HL_E(3)_BLK4repl_1993	Size_DblN_peak_HL_E(3)_BLK4repl_1993	0.832
Size_95%width_FALLEARLY_W(31)	Size_inflection_FALLEARLY_W(31)	0.834
Age_DblN_ascend_se_GRSC_C(49)	Age_DblN_peak_GRSC_C(49)	0.856
Size_DblN_ascend_se_PRIV_C(20)_BLK5repl_2007	Size_DblN_peak_PRIV_C(20)_BLK5repl_2007	0.856
Size_95%width_GFISHER_C(5)_BLK6repl_2016	Size_inflection_GFISHER_C(5)_BLK6repl_2016	0.870
Size_95%width_LL_W(7)_BLK4repl_1993	Size_inflection_LL_W(7)_BLK4repl_1993	0.872
Size_DblN_ascend_se_HBT_W(16)_BLK5repl_2007	Size_DblN_peak_HBT_W(16)_BLK5repl_2007	0.881
Size_DblN_ascend_se_PRIV_W(19)_BLK5repl_2007	Size_DblN_peak_PRIV_W(19)_BLK5repl_2007	0.887
Size_DblN_ascend_se_HBT_C(17)_BLK5repl_2007	Size_DblN_peak_HBT_C(17)_BLK5repl_2007	0.890
Age_95%width_BLL_C(11)	Age_inflection_BLL_C(11)	0.898
Size_95%width_LL_W(7)	Size_inflection_LL_W(7)	0.909
Size_DblN_ascend_se_HL_W(1)_BLK4repl_2007	Size_DblN_peak_HL_W(1)_BLK4repl_2007	0.913
Retain_L_asymptote_logit_PRIV_C(20)_BLK3repl_2007	Size_DblN_start_logit_PRIV_C(20)_BLK5repl_2007	0.920
Size_DblN_ascend_se_PRIV_C(20)_BLK5repl_1995	Size_DblN_peak_PRIV_C(20)_BLK5repl_1995	0.928
Retain_L_asymptote_logit_HBT_C(17)_BLK3repl_2007	Size_DblN_start_logit_HBT_C(17)_BLK5repl_2007	0.933
Size_DblN_ascend_se_CBT_C(13)	Size_DblN_peak_CBT_C(13)	0.934

**Table 85 Continued.** Summary of correlated parameters with correlation coefficients > 0.7 for Gulf of Mexico Red Snapper from the SEDAR 74 base model.

Parameter 1	Parameter 2	Correlation
Size_DblN_ascend_se_HL_W(1)_BLK4repl_1993	Size_DblN_peak_HL_W(1)_BLK4repl_1993	0.938
Size_DblN_ascend_se_CBT_C(13)_BLK5repl_1_2007	Size_DblN_peak_CBT_C(13)_BLK5repl_2007	0.940
Size_DblN_ascend_se_HBT_W(16)	Size_DblN_peak_HBT_W(16)	0.941
Size_DblN_ascend_se_HL_C(2)	Size_DblN_peak_HL_C(2)	0.946
Size_DblN_ascend_se_HL_C(2)_BLK4repl_2007	Size_DblN_peak_HL_C(2)_BLK4repl_2007	0.951
Size_DblN_ascend_se_HBT_W(16)_BLK5repl_1995	Size_DblN_peak_HBT_W(16)_BLK5repl_1995	0.962
Size_DblN_ascend_se_HBT_C(17)_BLK5repl_1995	Size_DblN_peak_HBT_C(17)_BLK5repl_1995	0.966
Size_DblN_ascend_se_HL_E(3)_BLK4repl_2007	Size_DblN_peak_HL_E(3)_BLK4repl_2007	0.968
Size_DblN_ascend_se_PRIV_W(19)_BLK5repl_1995	Size_DblN_peak_PRIV_W(19)_BLK5repl_1995	0.971
Size_DblN_ascend_se_CBT_W(14)	Size_DblN_peak_CBT_W(14)	0.975
Size_DblN_ascend_se_CBT_W(14)_BLK5repl_1995	Size_DblN_peak_CBT_W(14)_BLK5repl_1995	0.979
Size_DblN_ascend_se_CBT_C(13)_BLK5repl_1_1995	Size_DblN_peak_CBT_C(13)_BLK5repl_1995	0.995

**Table 86.** Summary of correlated parameters with correlation coefficients > 0.95 for Gulf of Mexico Red Snapper from the SEDAR 74 base model.

Parameter 1	Parameter 2	Correlation
Size_DblN_ascend_se_HL_C(2)_BLK4repl_2007	Size_DblN_peak_HL_C(2)_BLK4repl_2007	0.951
Size_DblN_ascend_se_HBT_W(16)_BLK5repl_1995	Size_DblN_peak_HBT_W(16)_BLK5repl_1995	0.962
Size_DblN_ascend_se_HBT_C(17)_BLK5repl_1995	Size_DblN_peak_HBT_C(17)_BLK5repl_1995	0.966
Size_DblN_ascend_se_HL_E(3)_BLK4repl_2007	Size_DblN_peak_HL_E(3)_BLK4repl_2007	0.968
Size_DblN_ascend_se_PRIV_W(19)_BLK5repl_1995	Size_DblN_peak_PRIV_W(19)_BLK5repl_1995	0.971
Size_DblN_ascend_se_CBT_W(14)	Size_DblN_peak_CBT_W(14)	0.975
Size_DblN_ascend_se_CBT_W(14)_BLK5repl_1995	Size_DblN_peak_CBT_W(14)_BLK5repl_1995	0.979
Size_DblN_ascend_se_CBT_C(13)_BLK5repl_1995	Size_DblN_peak_CBT_C(13)_BLK5repl_1995	0.995

## Figures

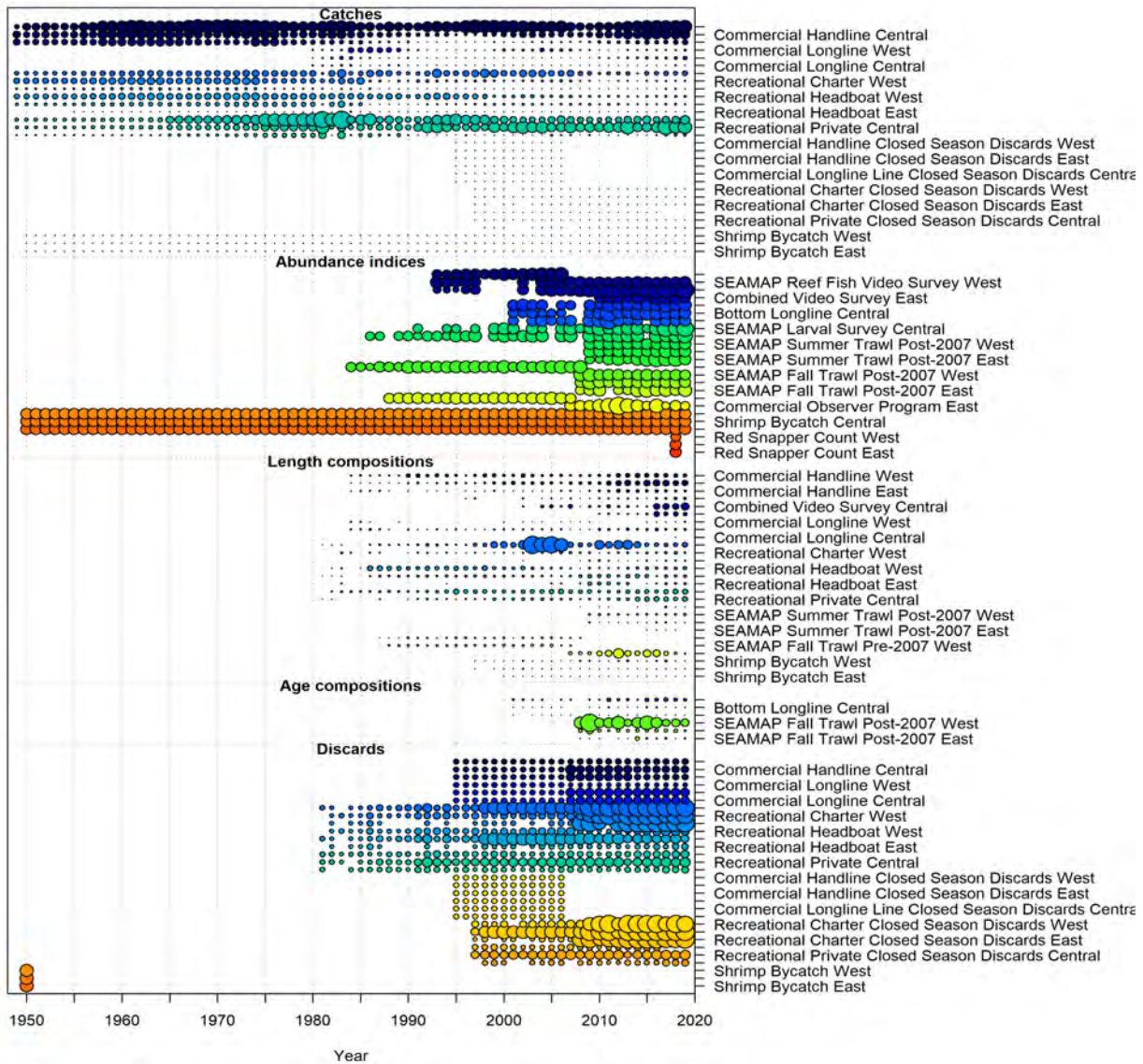


Figure 1. Data sources used in the Gulf of Mexico Red Snapper Stock Synthesis assessment model. Circle area is relative within a data type. Circles are proportional to total catch for catches; to precision for indices, discards, and mean body weight observations; and to total sample size for compositions and mean weight- or length-at-age observations. Note that since the circles are scaled relative to maximum within each type, the scaling between separate data types should not be compared. Due to the number of data sources used in this assessment some labels may be missing. See section 2 (Data Review and Update) for complete list of data sources and time frames.

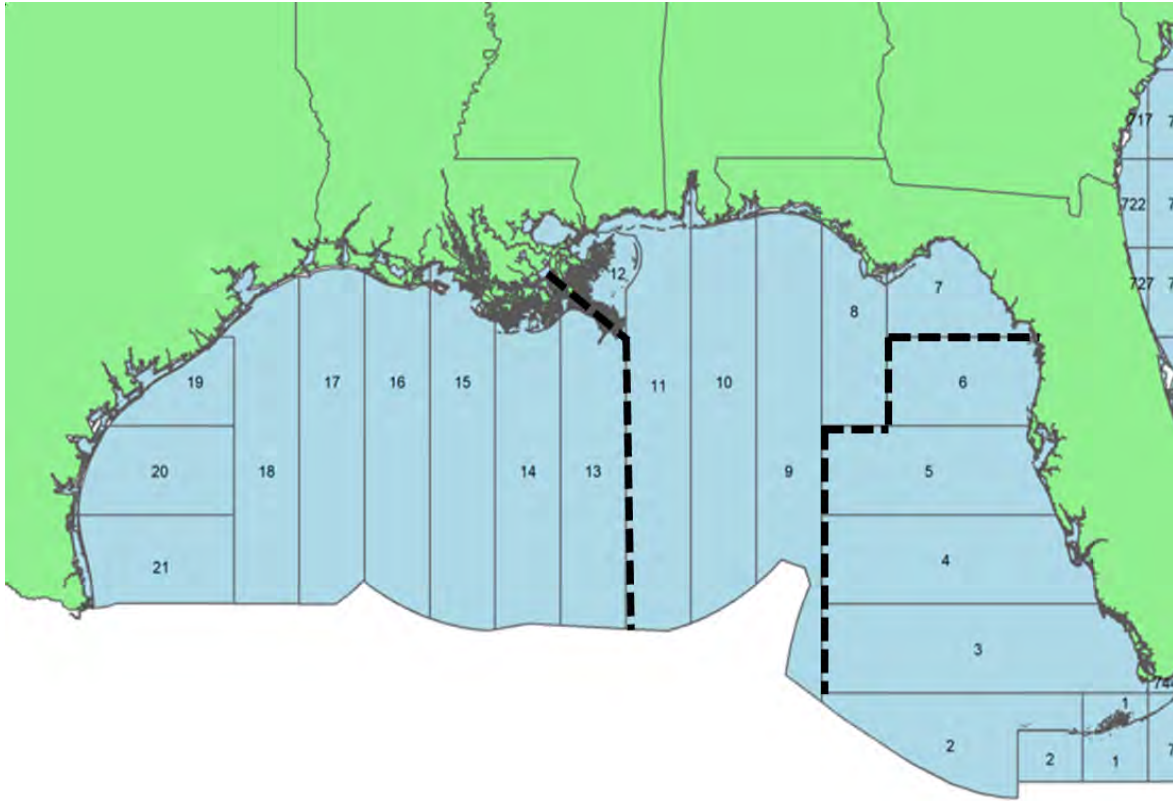


Figure 2. National Marine Fisheries Service (NMFS) fishing area in the Gulf of Mexico, divided into 23 statistical fishing zones. Thick black dashed lines indicate stock boundaries used for SEDAR 74: statistical zone 12/13- Mississippi River outflow, zone 9/10 - De Soto Canyon, zone 7/8 - Cape San Blas, and zone 7/6 - Big Bend.

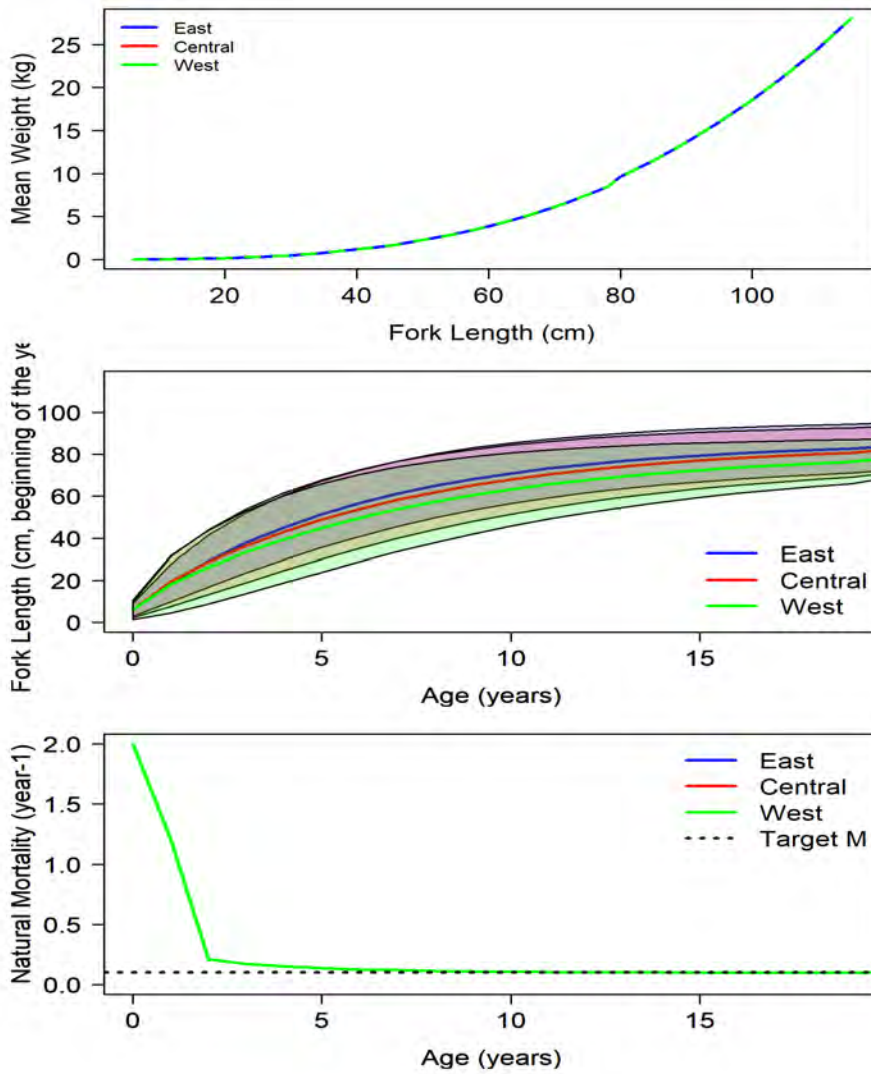


Figure 3. Mean weight-at-length (top panel), growth curves (with 95% confidence intervals; middle panel), and natural mortality (bottom panel) used in the assessment model for Gulf of Mexico Red Snapper.

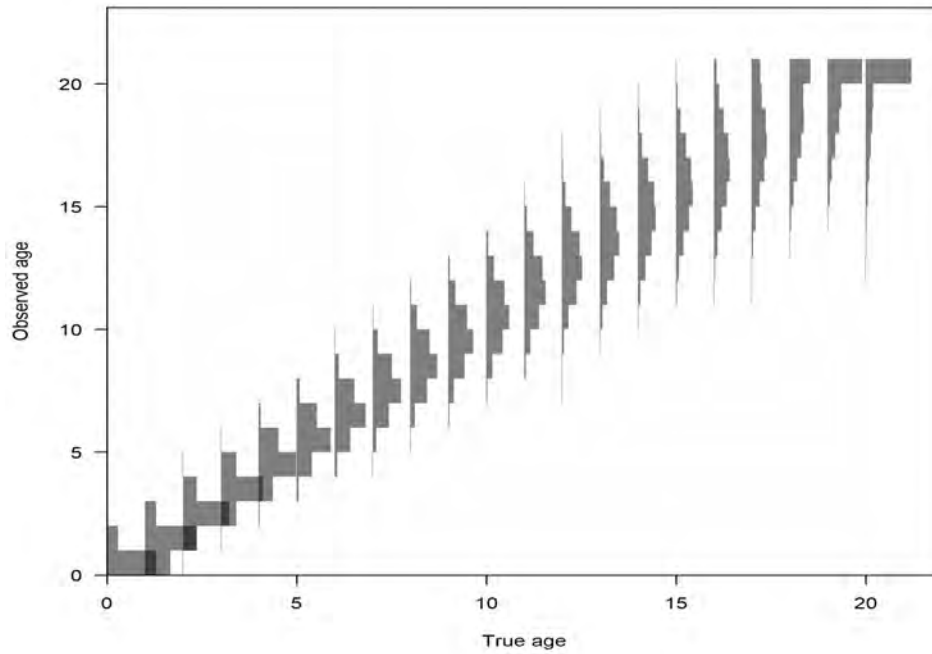
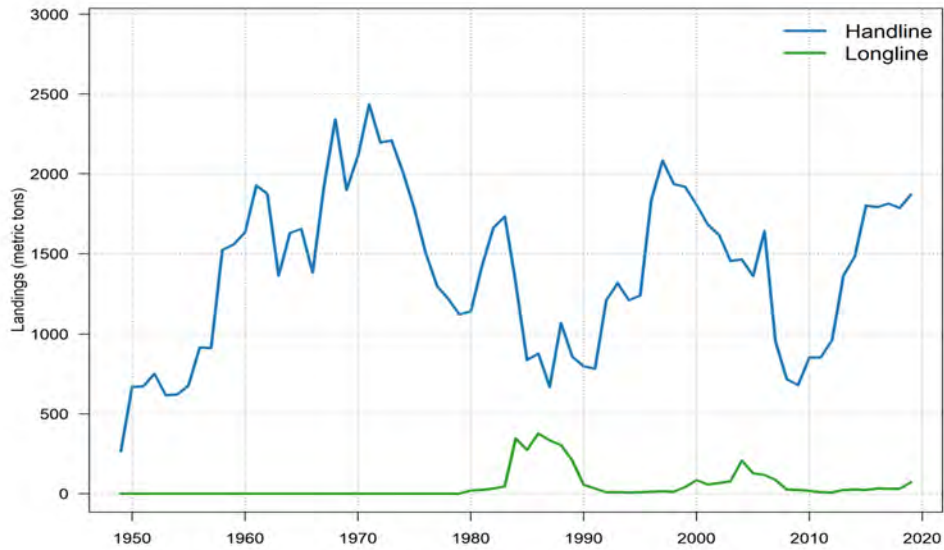


Figure 4. Distribution of observed age at true age for the ageing error matrix used for all ages input in SEDAR 74.



**West**



**Central**

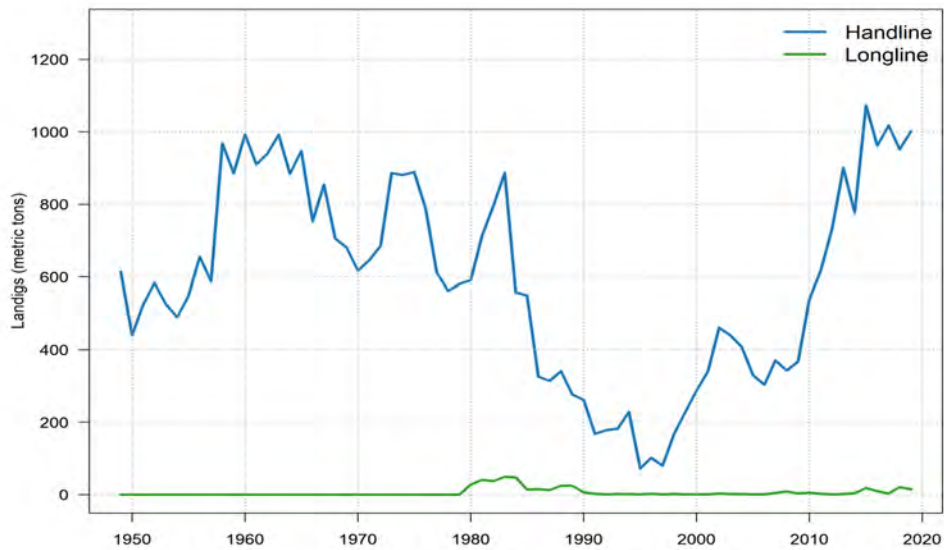


Figure 5. Gulf of Mexico Red Snapper observed commercial landings by fishery and region for SEDAR 74. Commercial landings in weight (mt).



**East**

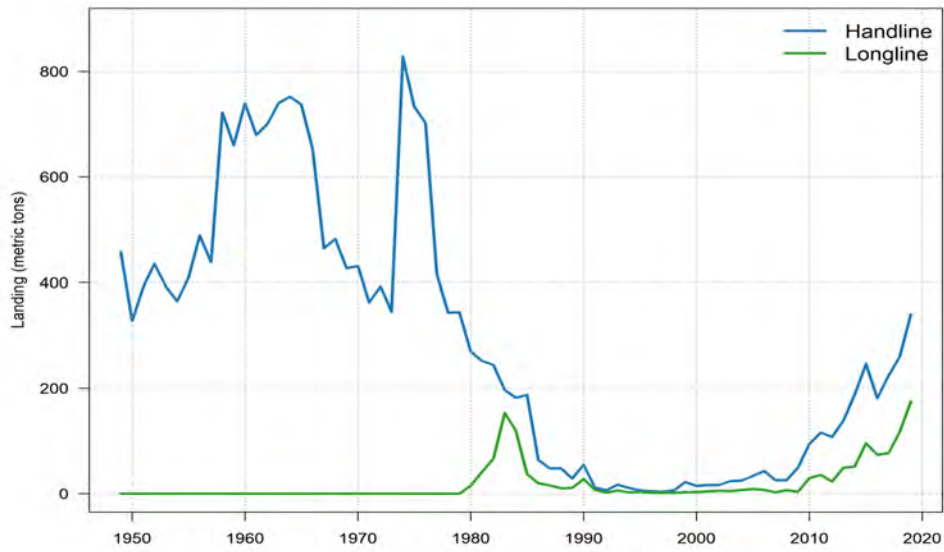
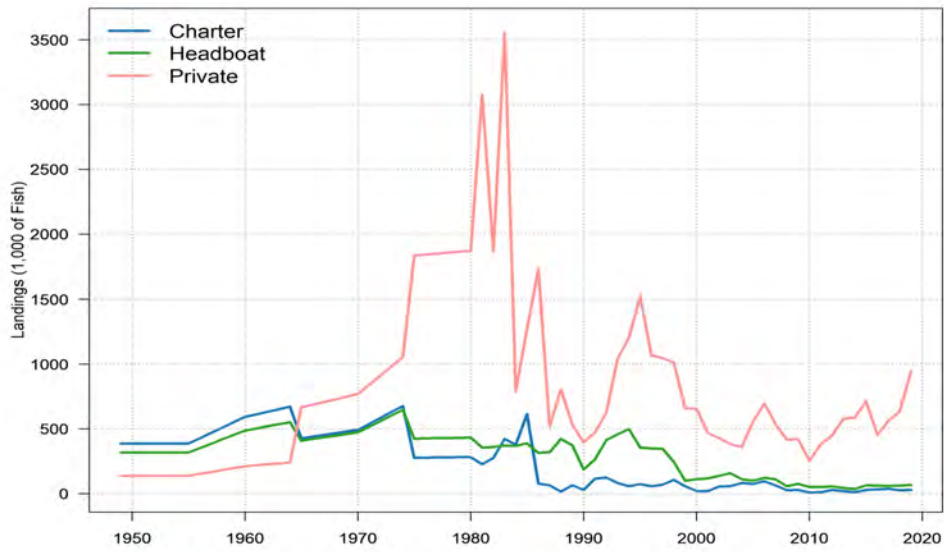


Figure 5 Continued. Gulf of Mexico Red Snapper observed commercial landings by fishery and region for SEDAR 74. Commercial landings in weight (mt).

West



Central

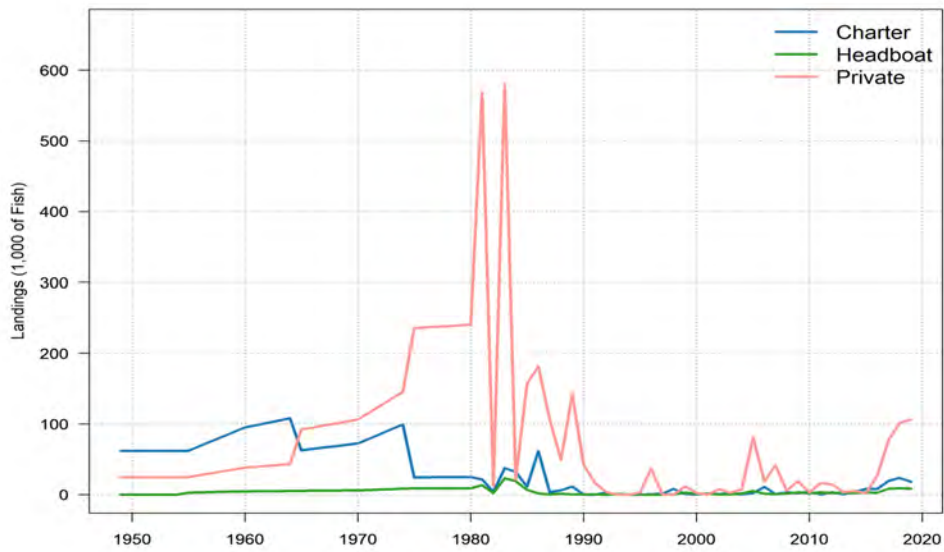


Figure 6. Gulf of Mexico Red Snapper observed recreational landings by fishery for SEDAR 74. Recreational landings are in thousands of fish.

**East**

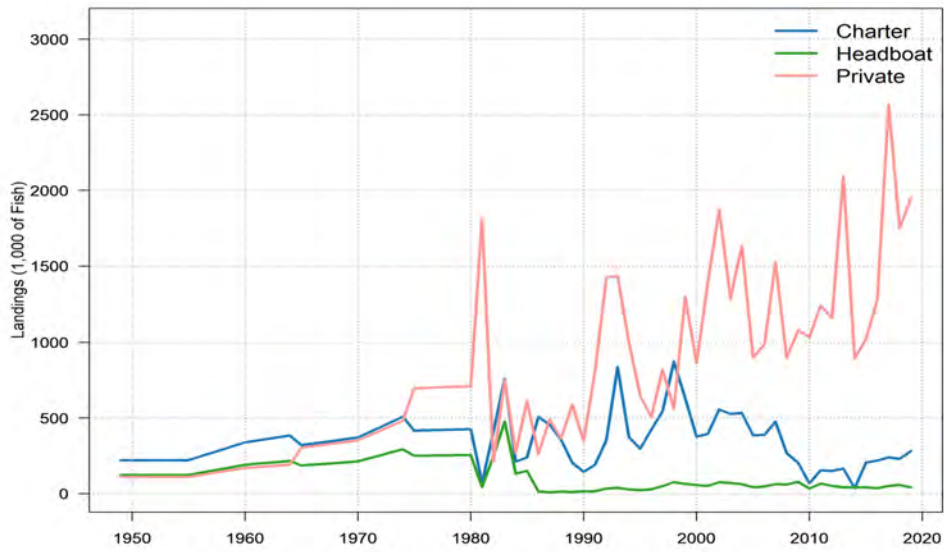
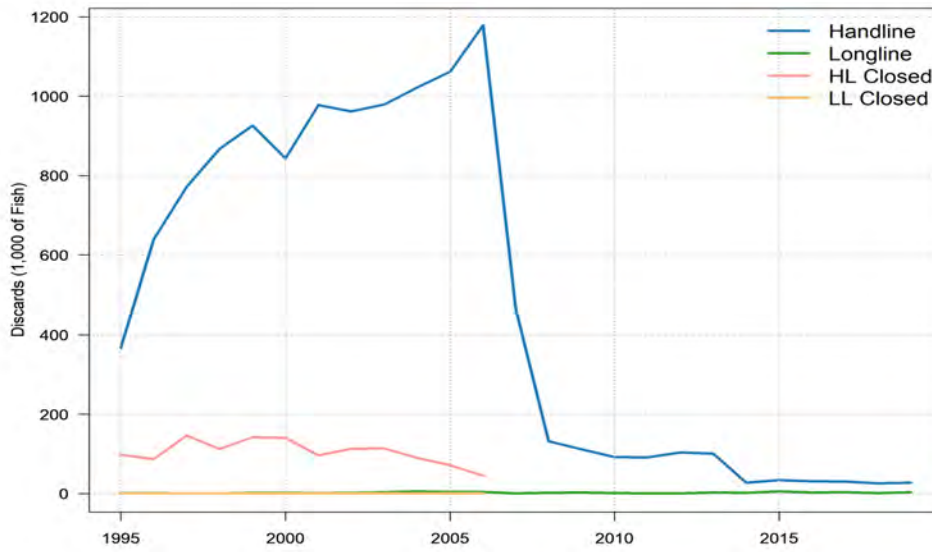


Figure 6 Continued. Gulf of Mexico Red Snapper observed recreational landings by fishery for SEDAR 74. Recreational landings are in thousands of fish.

**West**



**Central**

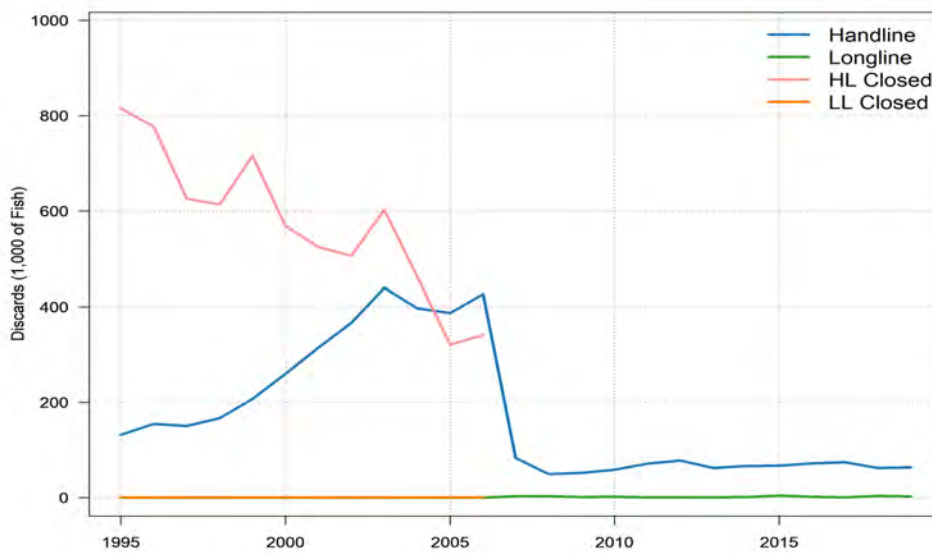


Figure 7. Gulf of Mexico Red Snapper observed commercial discards by fishery and region for SEDAR 74. Commercial discards are in thousands of fish.

East

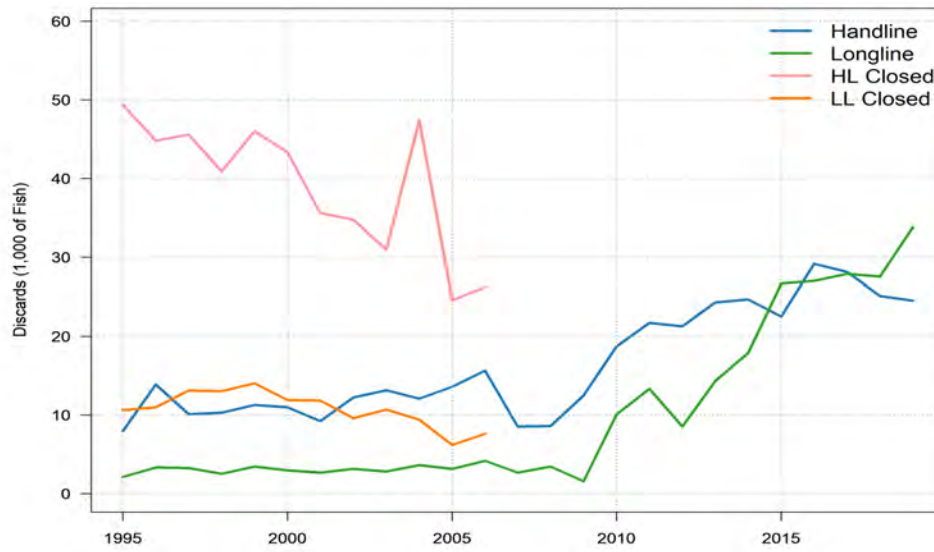
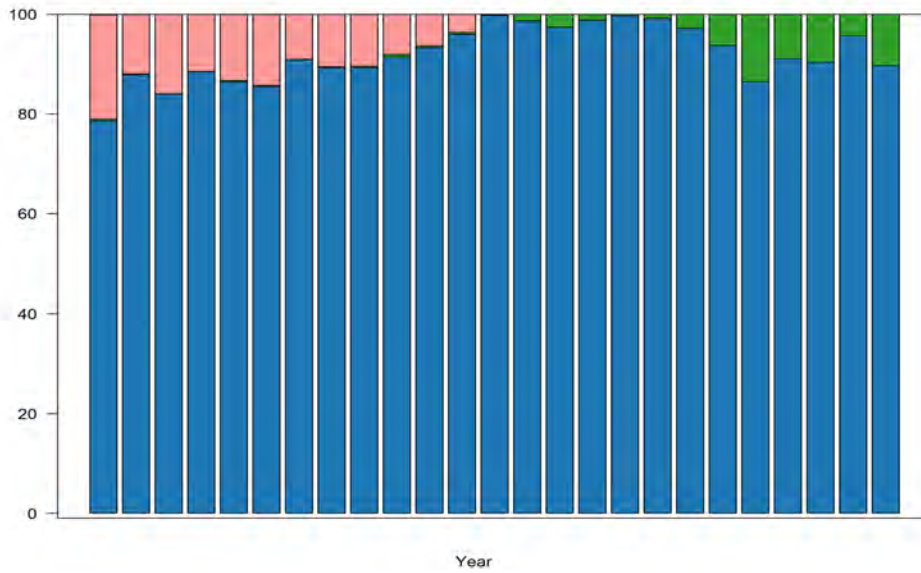


Figure 7 Continued. Gulf of Mexico Red Snapper observed commercial discards by fishery and region for SEDAR 74. Commercial discards are in thousands of fish.

**West**



**Central**

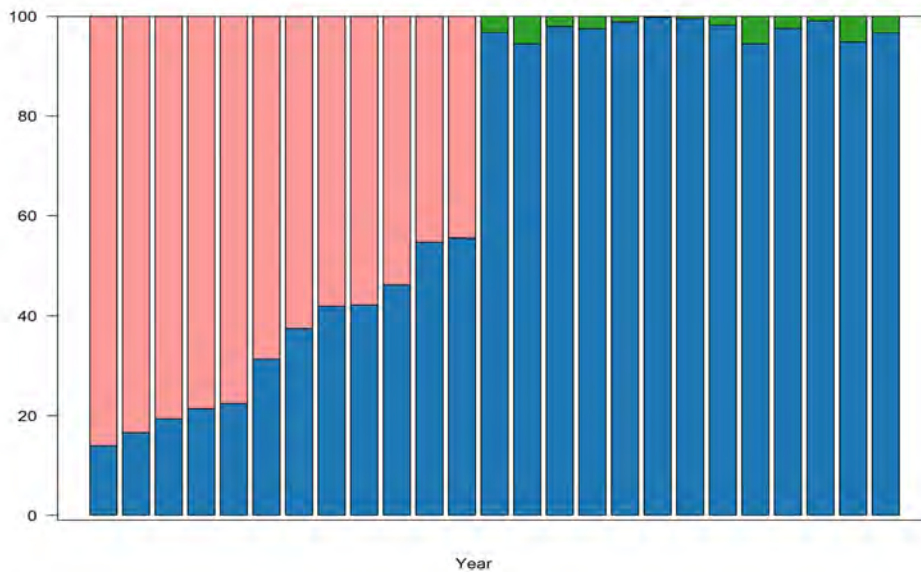


Figure 8. Proportion of Gulf of Mexico Red Snapper observed commercial discards by fishery and region for SEDAR 74. Colors align with those in the previous figure.

**East**

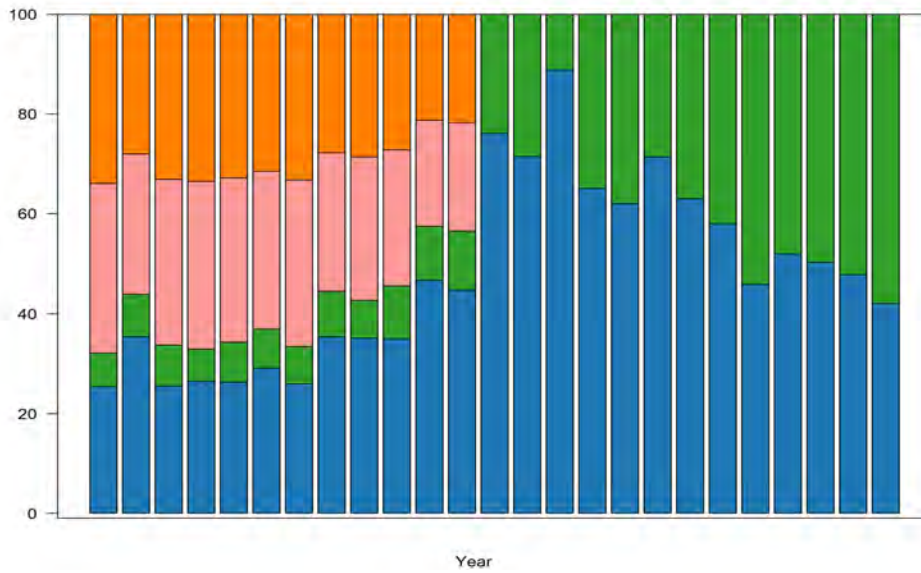
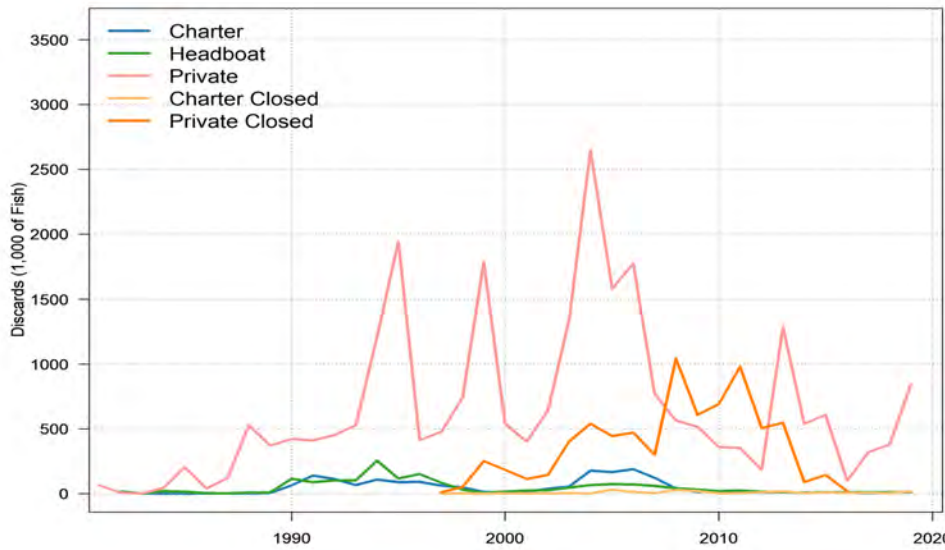


Figure 8 Continued. Proportion of Gulf of Mexico Red Snapper observed commercial discards by fishery and region for SEDAR 74. Colors align with those in the previous figure.

**West**



**Central**

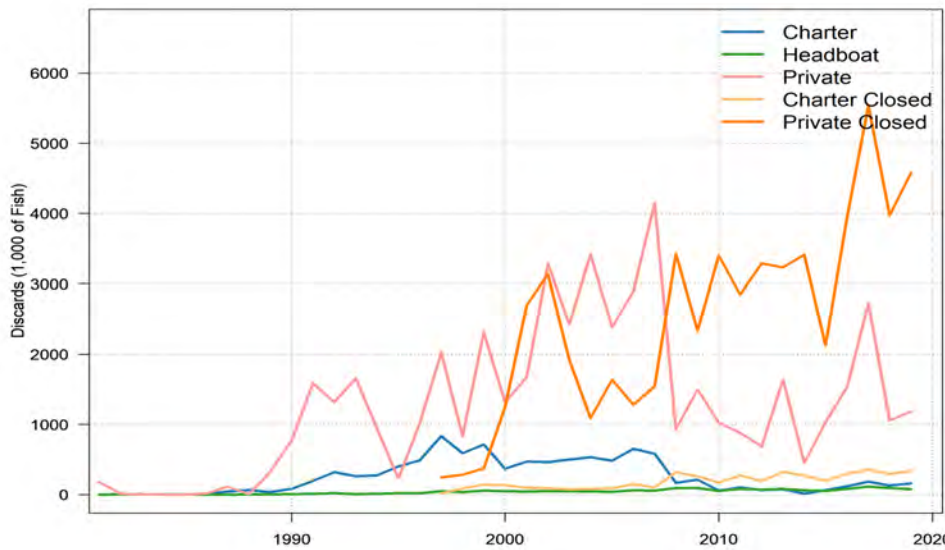


Figure 9. Gulf of Mexico Red Snapper observed recreational discards by fishery for SEDAR 74. Recreational discards are in thousands of fish. East area y-axis is reduced to ensure trends in fleets that were not the Private Closed Season Discards were still visible. Unseen values for Private Closed season discards are 1492.56 in 2011, 669.67 in 2016, 523.3 in 2018 and 334.14 thousand fish in 2019.



East

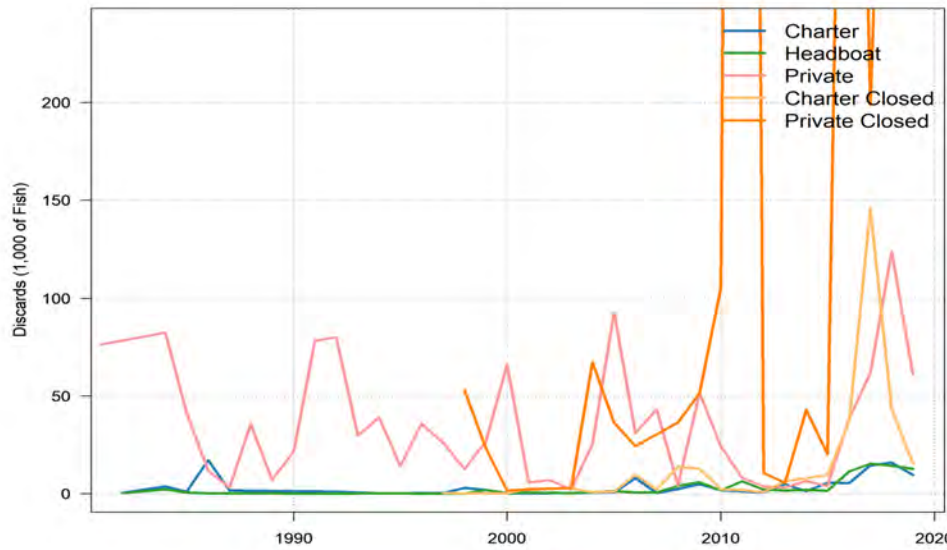


Figure 9 Continued. Gulf of Mexico Red Snapper observed recreational discards by fishery for SEDAR 74. Recreational discards are in thousands of fish. East area y-axis is reduced to ensure trends in fleets that were not the Private Closed Season Discards were still visible. Unseen values for Private Closed season discards are 1492.56 in 2011, 669.67 in 2016, 523.3 in 2018 and 334.14 thousand fish in 2019.

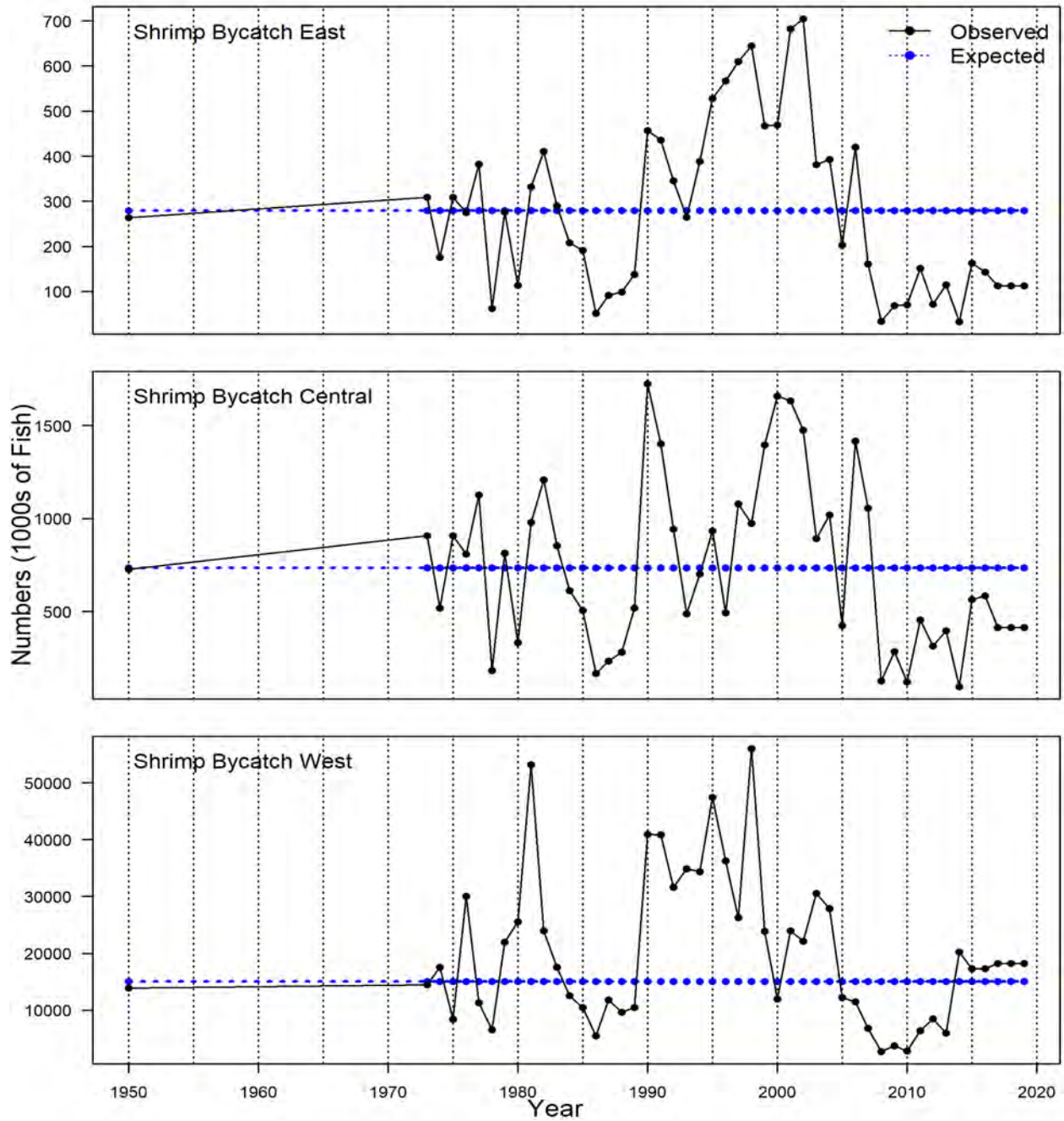


Figure 10. Shrimp Trawl bycatch for Gulf of Mexico Red Snapper observed and expected indices (blue lines) for SEDAR 74. Dashed vertical lines identify five year intervals.

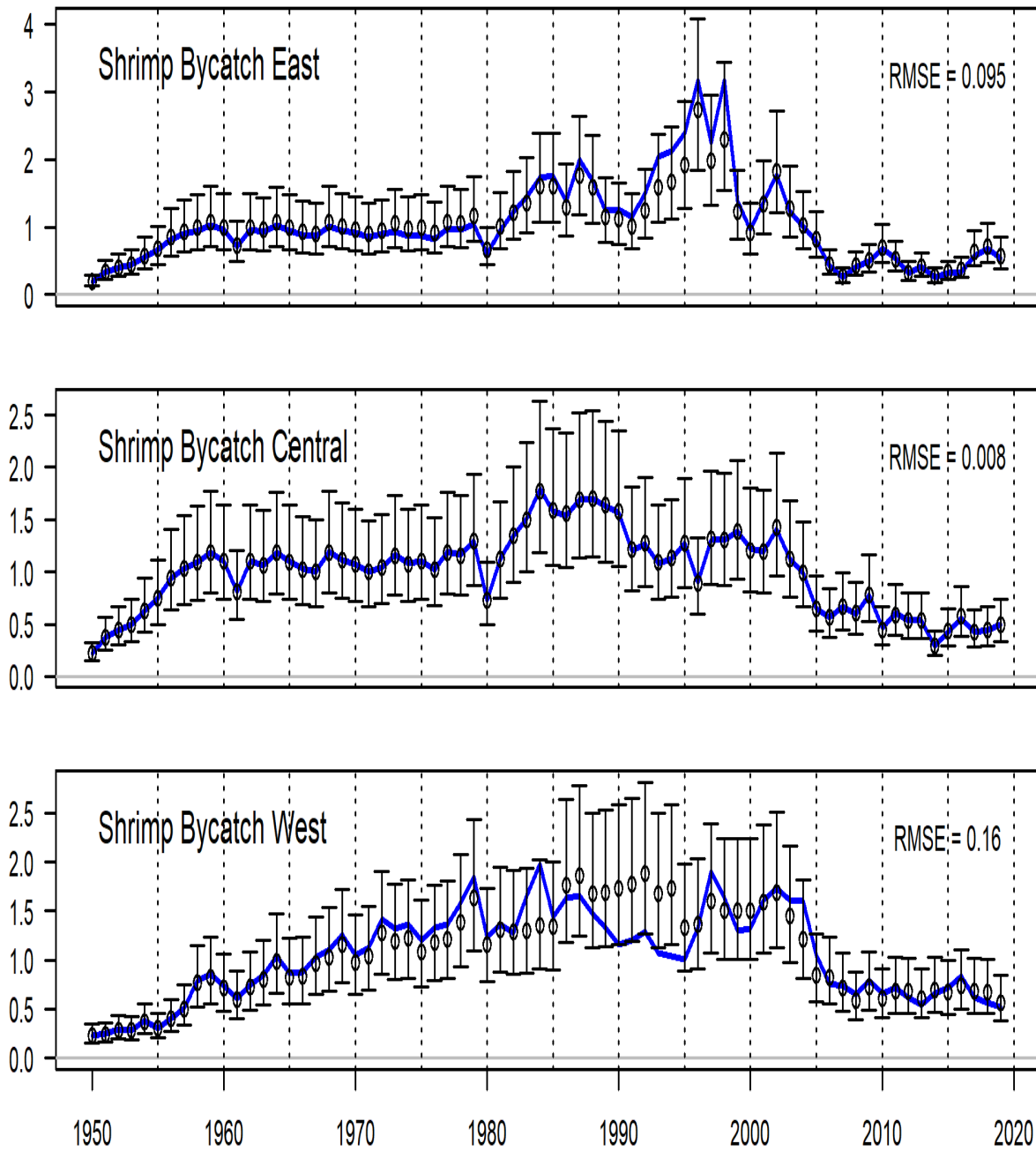


Figure 11. Effort time series for Shrimp Trawl bycatch and associated 95% uncertainty interval around index values based on the model assumption of lognormal error for Gulf of Mexico Red Snapper.

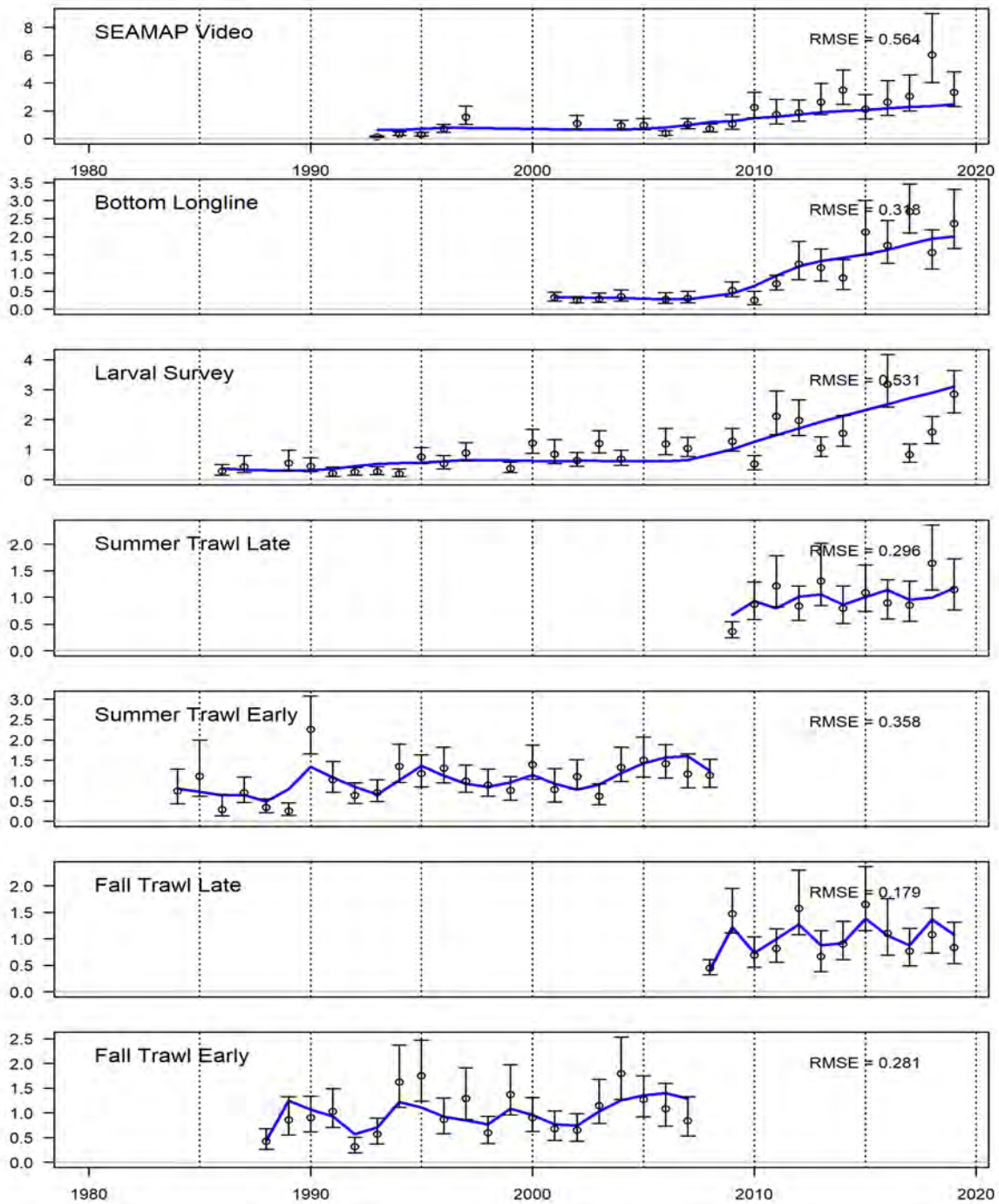


Figure 12. Western Gulf of Mexico Red Snapper observed and expected indices (blue lines) for SEDAR 74. Dashed vertical lines identify five year intervals. The root mean squared error (RMSE) is also provided.

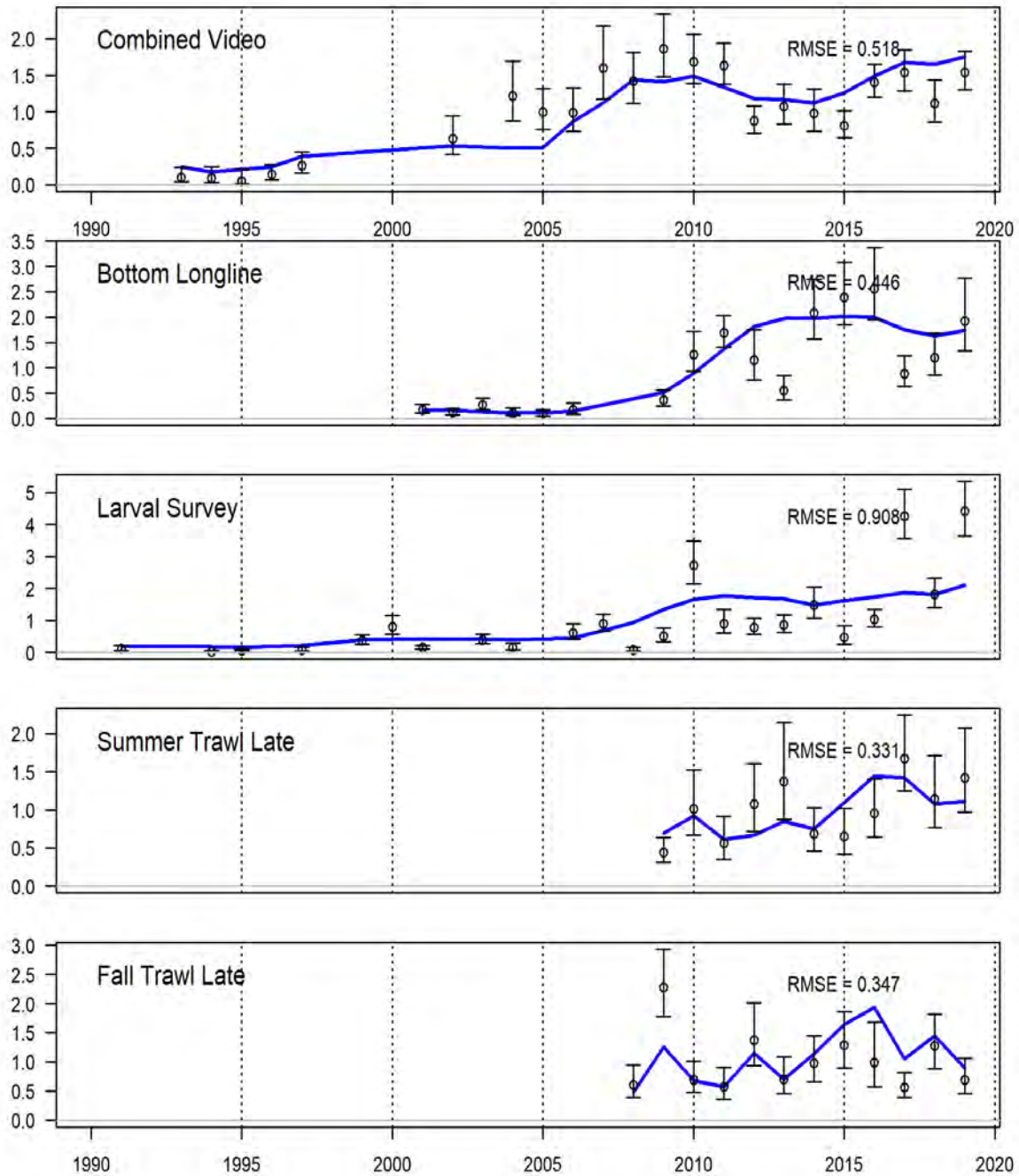


Figure 13. Central Gulf of Mexico Red Snapper observed and expected indices (blue lines) for SEDAR 74. Dashed vertical lines identify five year intervals. The root mean squared error (RMSE) is also provided.



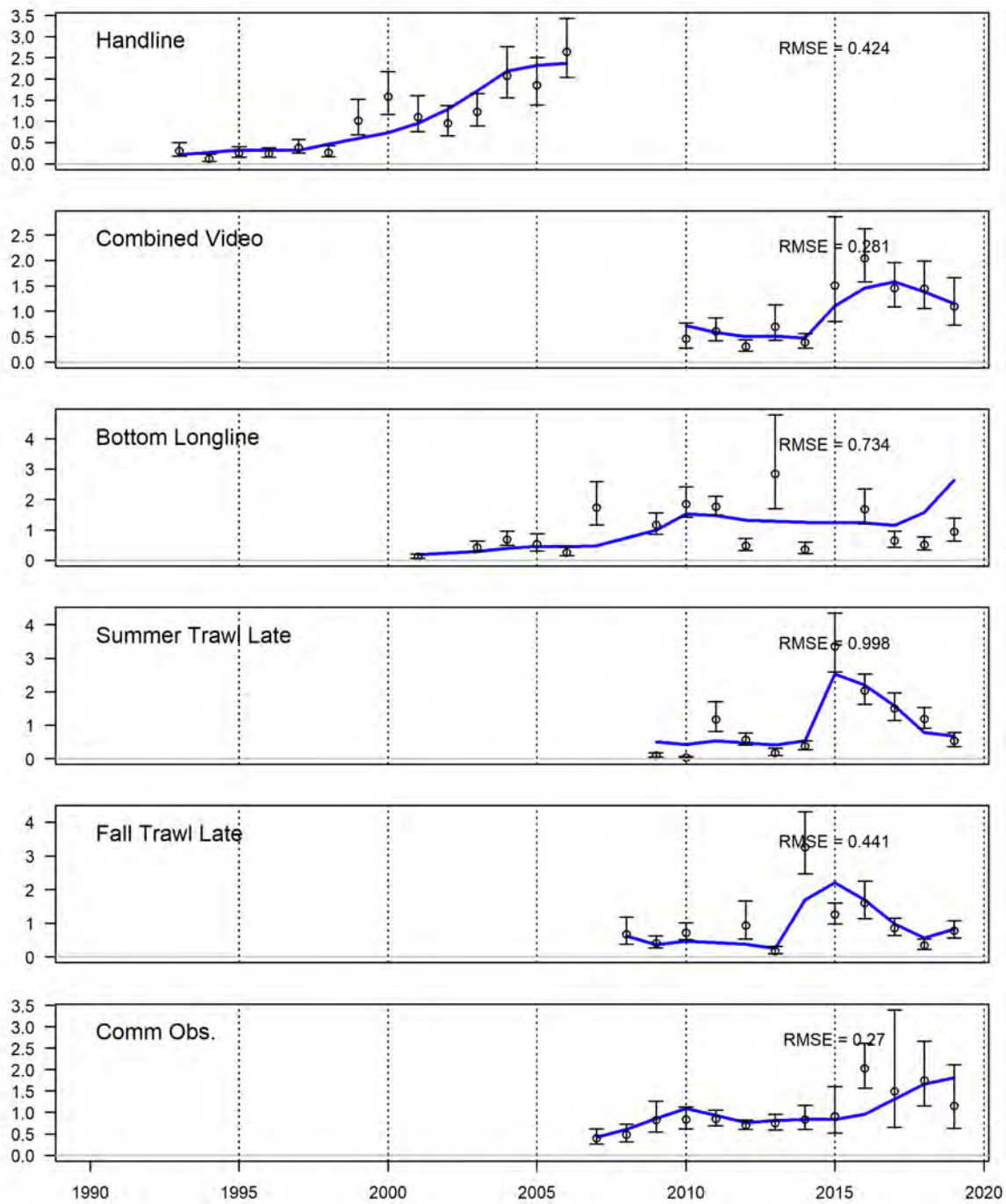


Figure 14. Eastern Gulf of Mexico Red Snapper observed and expected indices (blue lines) for SEDAR 74. Dashed vertical lines identify five year intervals. The root mean squared error (RMSE) is also provided.

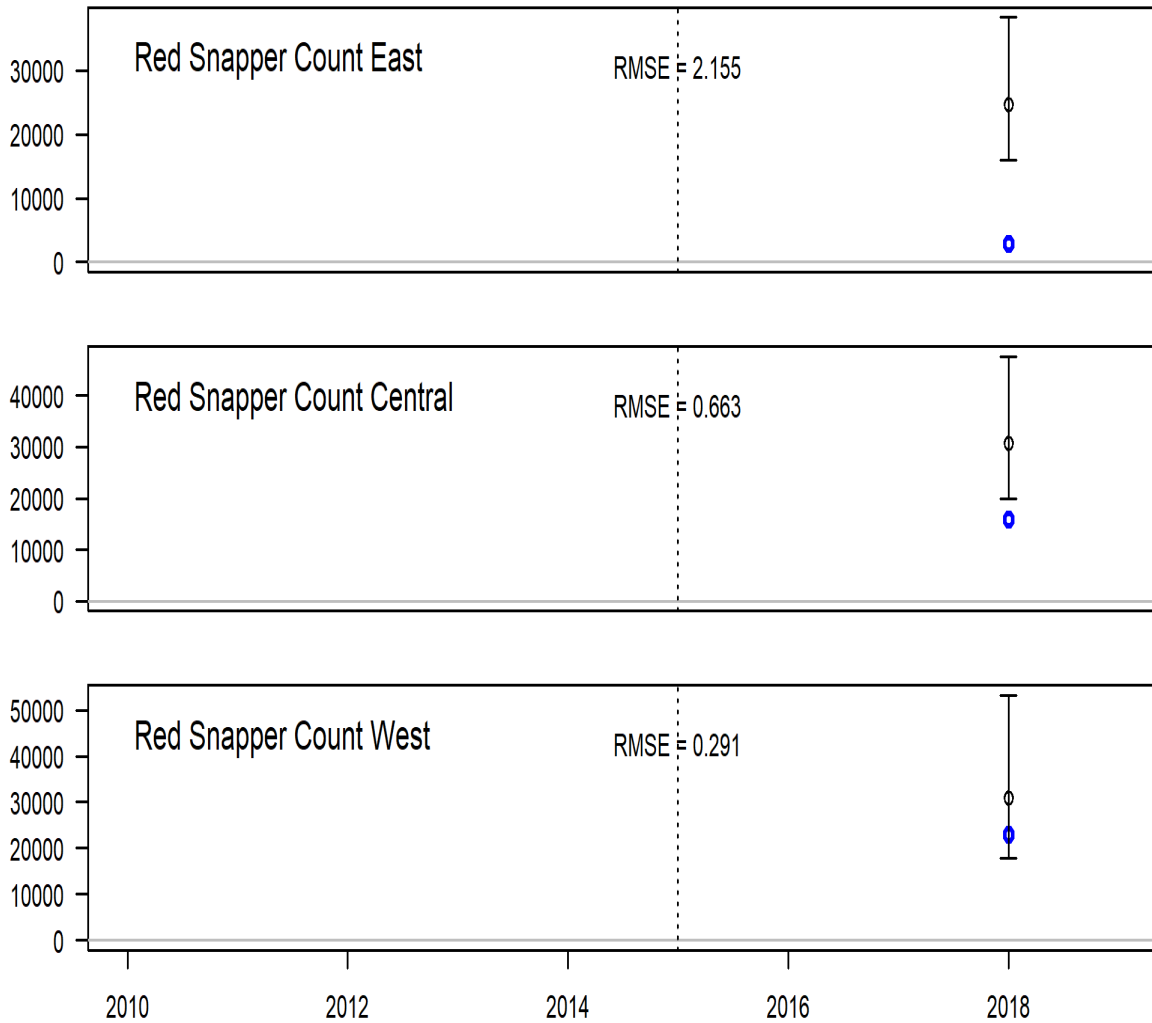


Figure 15. Absolute abundance and associated 95% uncertainty interval around values based on the model assumption of lognormal error for Gulf of Mexico Red Snapper.

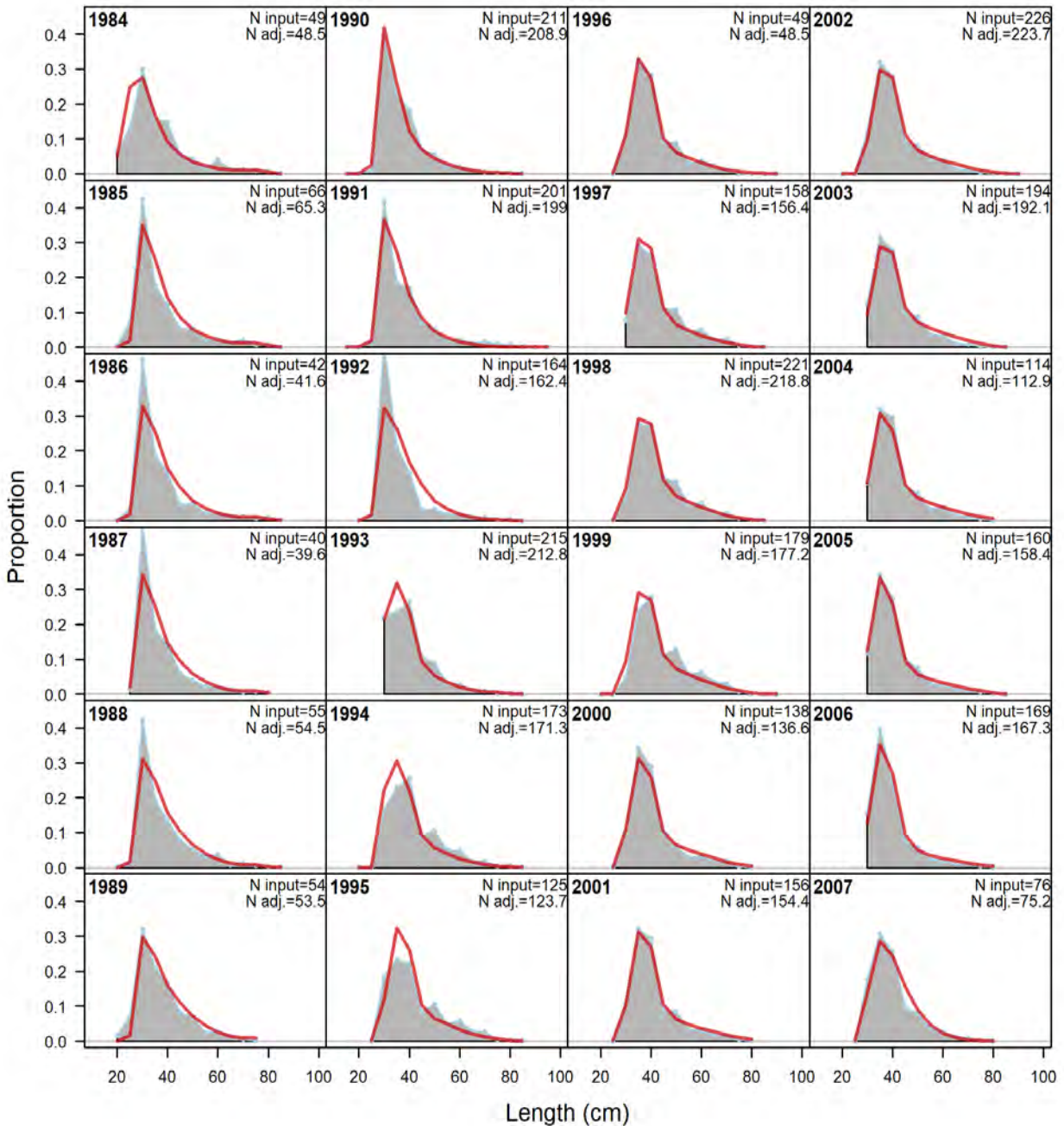


Figure 16. Length compositions, retained, Commercial Handline West. 'N input' is the input sample size. 'N adj.' is the sample size after adjustment by the Dirichlet-Multinomial  $\Theta$  parameter based on the formula  $N \text{ adj.} = 1 / (1 + \Theta) + N \Theta / (1 + \Theta)$ . For this fleet,  $\Theta = 69.402$  and the sample size multiplier is approximately  $\Theta / (1 + \Theta) = 0.986$ .\*



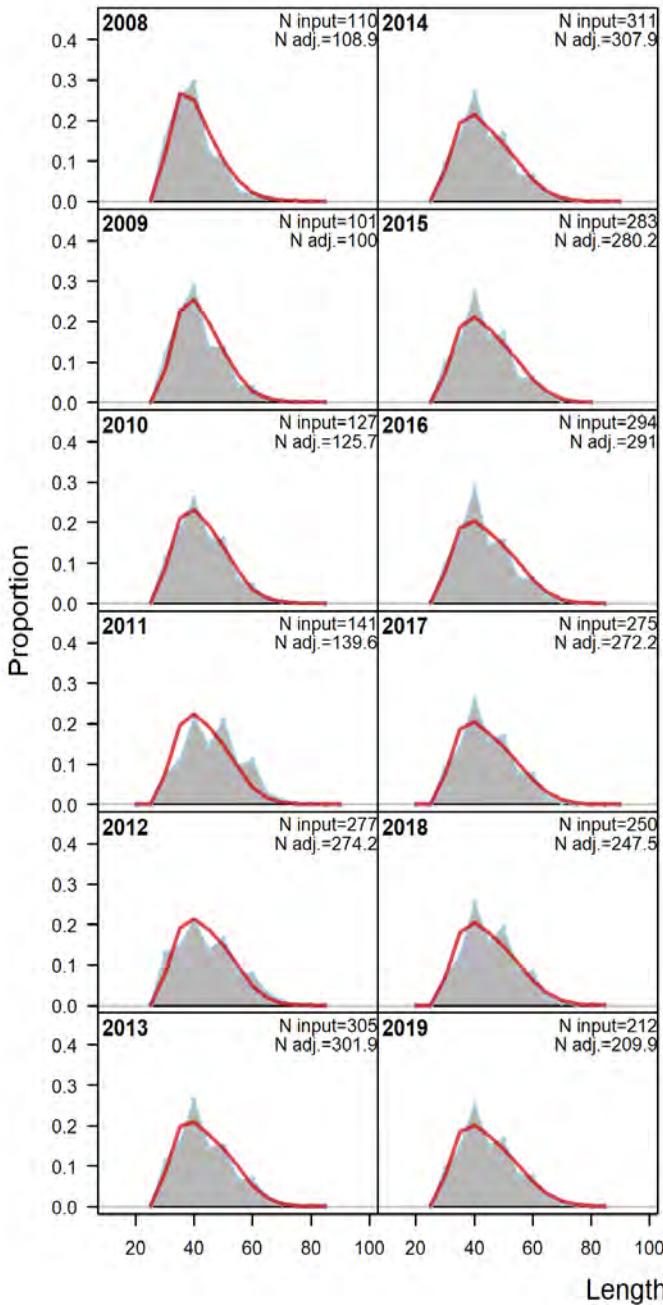


Figure 16 Continued. Length compositions, retained, Commercial Handline West. 'N input' is the input sample size. 'N adj.' is the sample size after adjustment by the Dirichlet-Multinomial  $\Theta$  parameter based on the formula  $N \text{ adj.} = 1 / (1 + \Theta) + N \Theta / (1 + \Theta)$ . For this fleet,  $\Theta = 69.402$  and the sample size multiplier is approximately  $\Theta / (1 + \Theta) = 0.986$ .\*

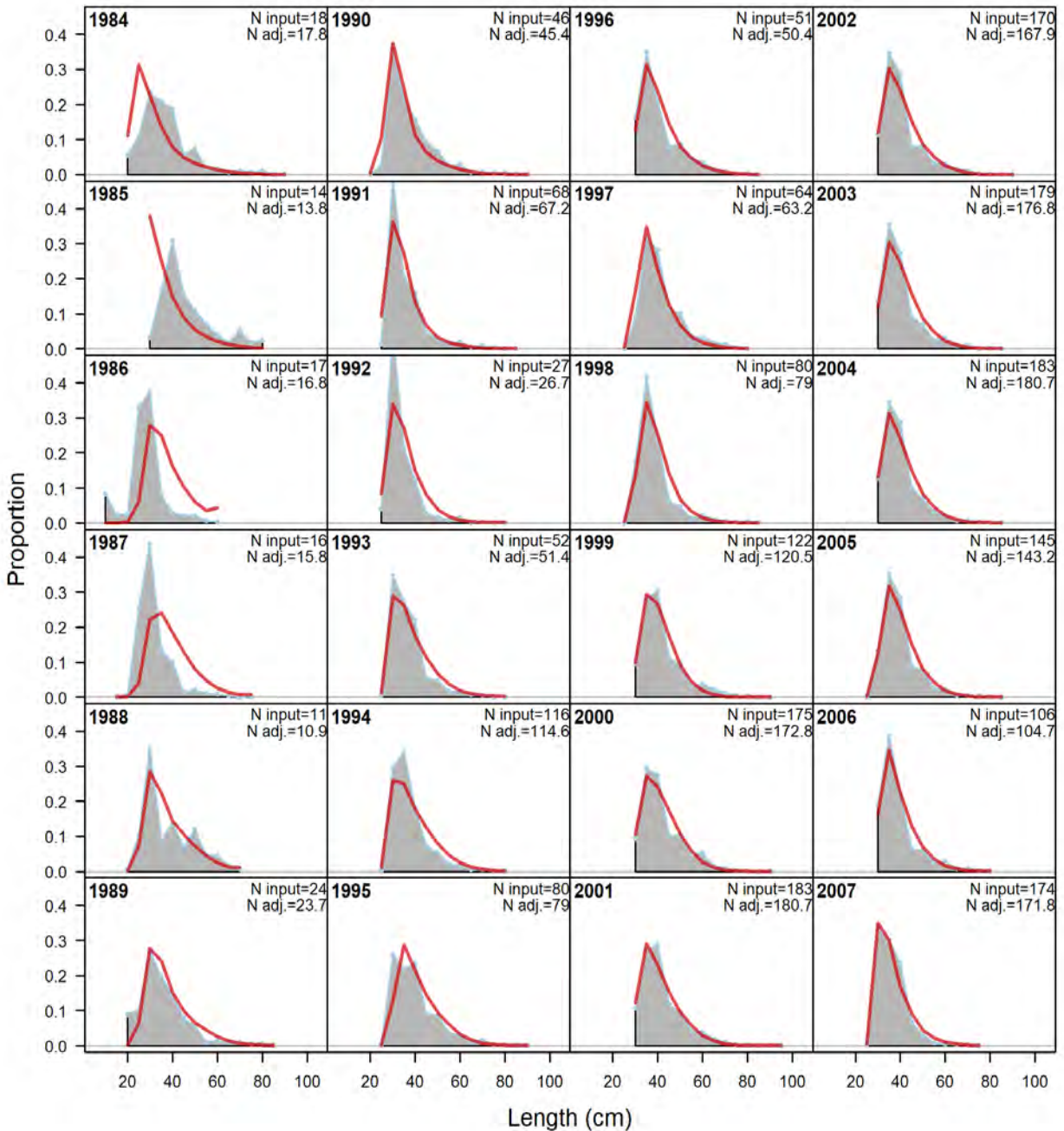


Figure 17. Length compositions, retained, Commercial Handline Central. 'N input' is the input sample size. 'N adj.' is the sample size after adjustment by the Dirichlet-Multinomial  $\Theta$  parameter based on the formula  $N \text{ adj.} = 1 / (1 + \Theta) + N \Theta / (1 + \Theta)$ . For this fleet,  $\Theta = 81.396$  and the sample size multiplier is approximately  $\Theta / (1 + \Theta) = 0.988$ .\*

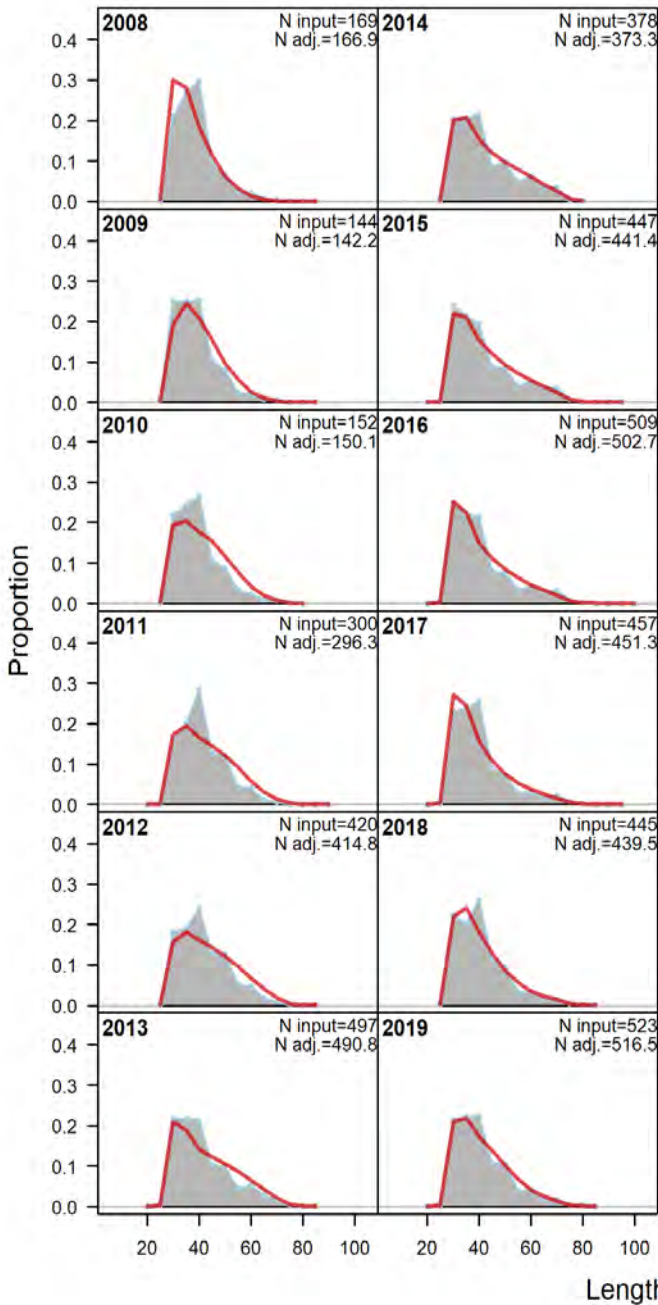


Figure 17 Continued. Length compositions, retained, Commercial Handline Central. 'N input' is the input sample size. 'N adj.' is the sample size after adjustment by the Dirichlet-Multinomial  $\Theta$  parameter based on the formula  $N \text{ adj.} = 1 / (1 + \Theta) + N \Theta / (1 + \Theta)$ . For this fleet,  $\Theta = 81.396$  and the sample size multiplier is approximately  $\Theta / (1 + \Theta) = 0.988$ .\*

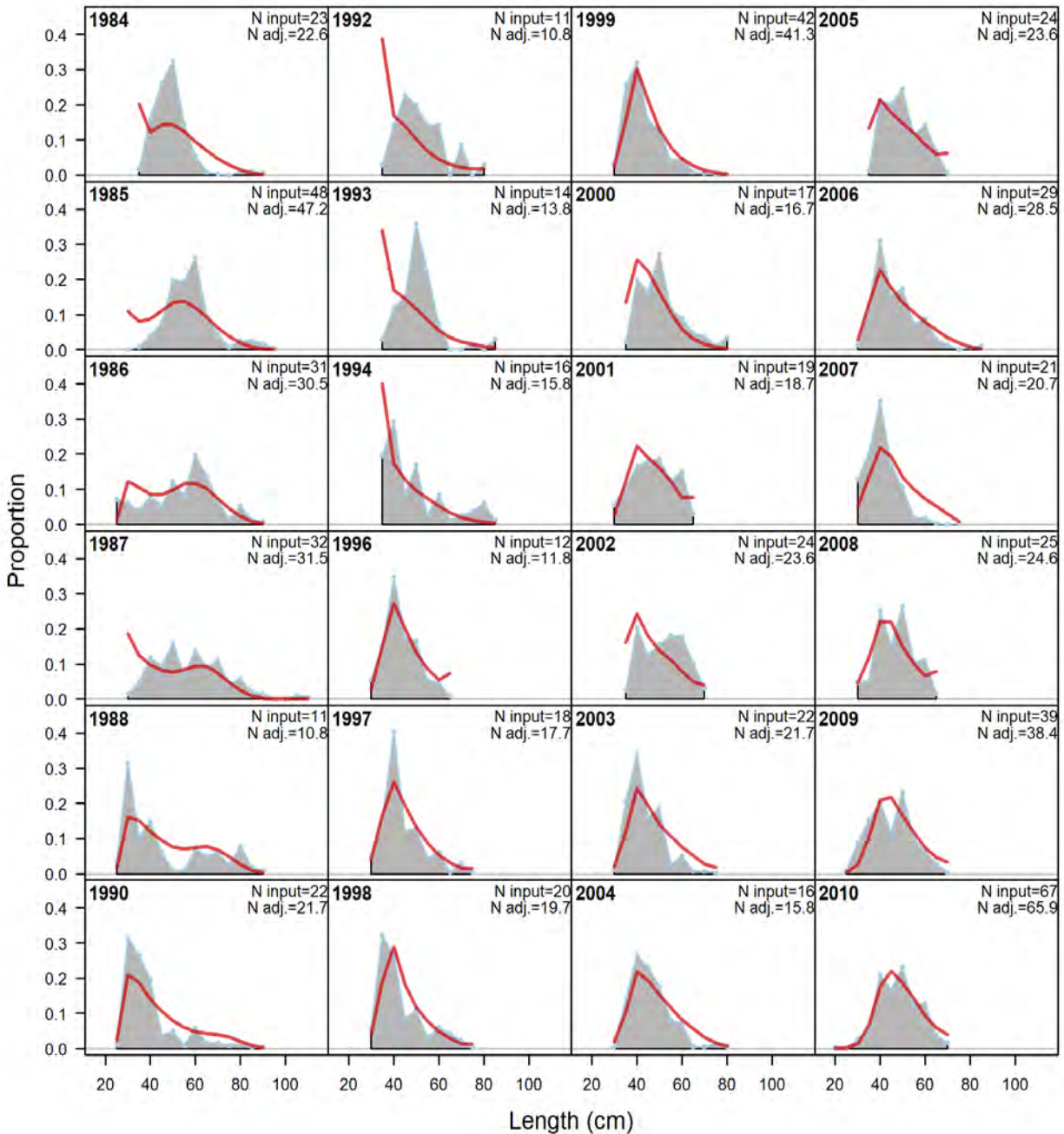


Figure 18. Length compositions, retained, Commercial Handline East. ‘N input’ is the input sample size. ‘N adj.’ is the sample size after adjustment by the Dirichlet-Multinomial  $\Theta$  parameter based on the formula  $N \text{ adj.} = 1 / (1 + \Theta) + N \Theta / (1 + \Theta)$ . For this fleet,  $\Theta = 69.402$  and the sample size multiplier is approximately  $\Theta / (1 + \Theta) = 0.986$ .\*



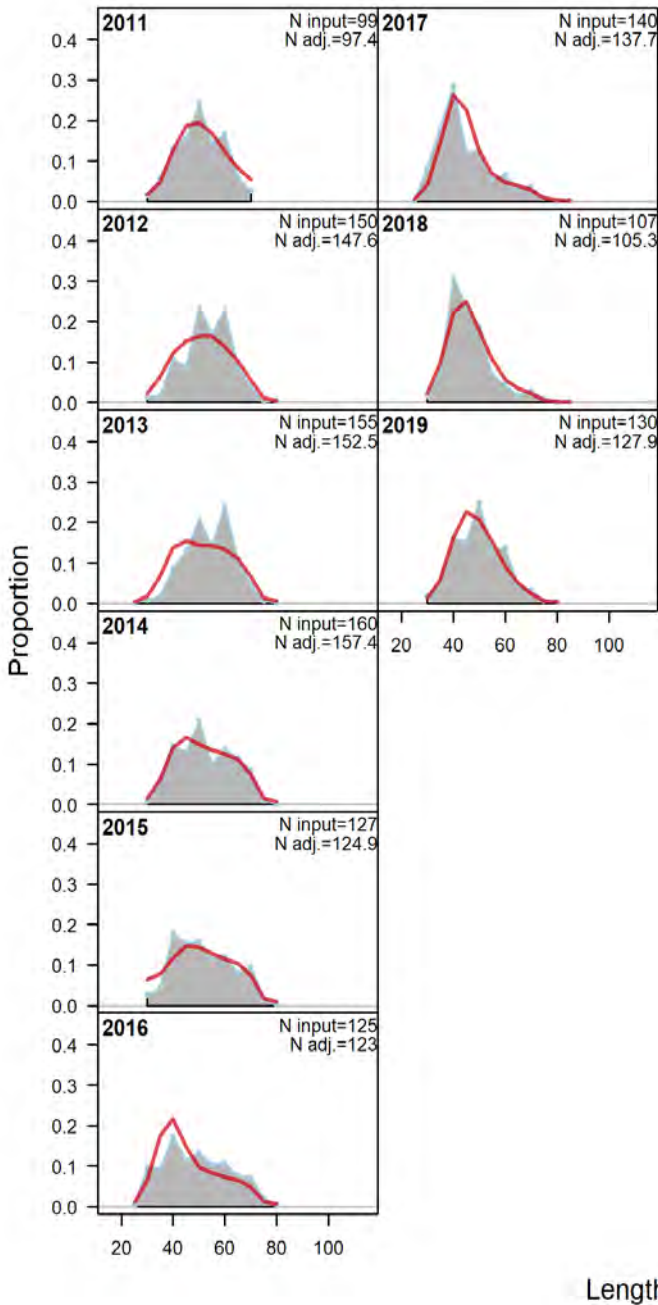


Figure 18 Continued. Length compositions, retained, Commercial Handline East. ‘N input’ is the input sample size. ‘N adj.’ is the sample size after adjustment by the Dirichlet-Multinomial  $\Theta$  parameter based on the formula  $N \text{ adj.} = 1 / (1+\Theta) + N \Theta / (1+\Theta)$ . For this fleet,  $\Theta = 69.402$  and the sample size multiplier is approximately  $\Theta / (1+\Theta) = 0.986$ .\*

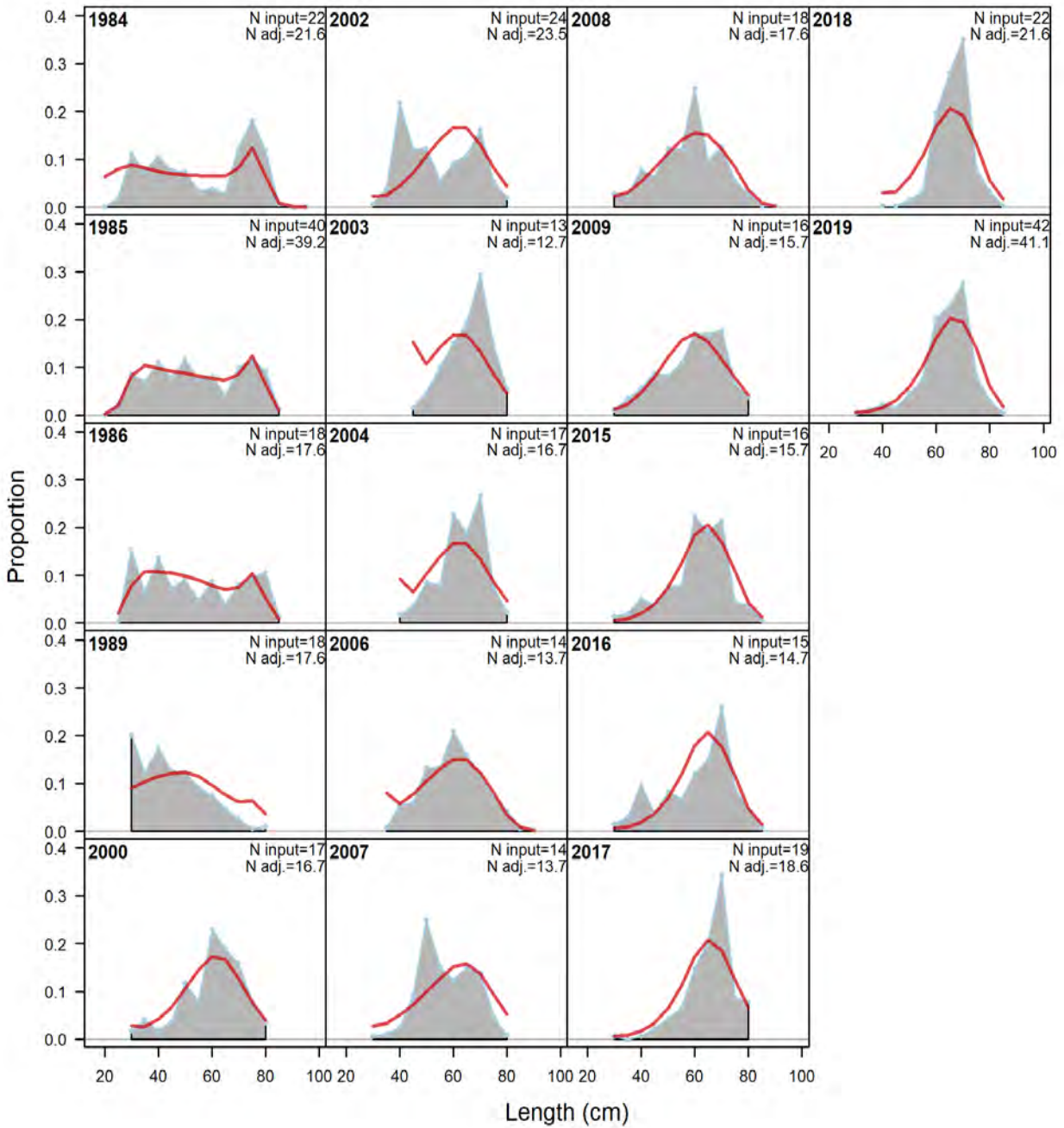


Figure 19. Length compositions, retained, Commercial Longline West. ‘N input’ is the input sample size. ‘N adj.’ is the sample size after adjustment by the Dirichlet-Multinomial  $\Theta$  parameter based on the formula  $N\ adj. = 1 / (1+\Theta) + N \Theta / (1+\Theta)$ . For this fleet,  $\Theta = 52.823$  and the sample size multiplier is approximately  $\Theta / (1+\Theta) = 0.981$ .\*

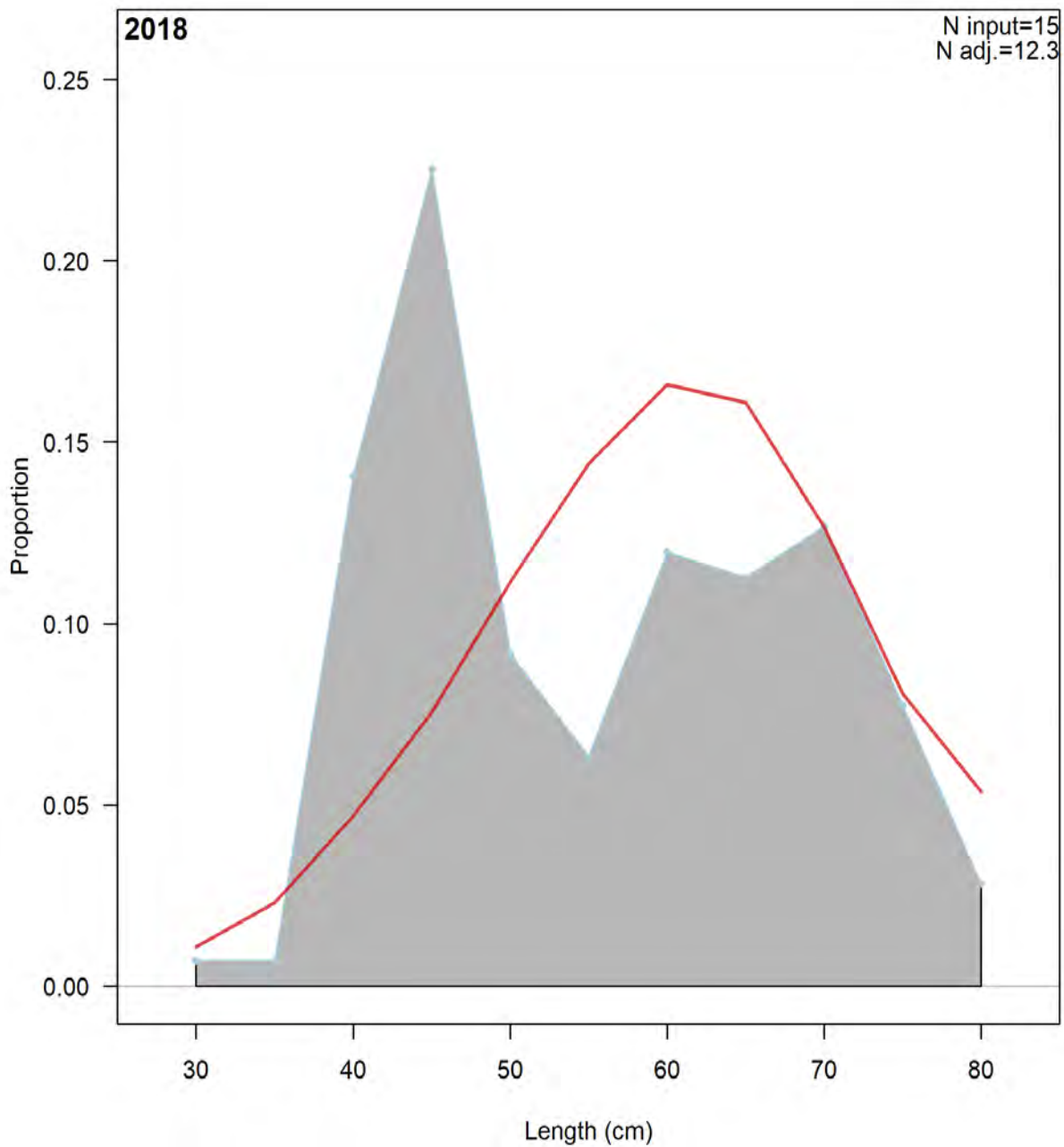


Figure 20. Length compositions, retained, Commercial Longline Central. ‘N input’ is the input sample size. ‘N adj.’ is the sample size after adjustment by the Dirichlet-Multinomial  $\Theta$  parameter based on the formula  $N\ adj. = 1 / (1+\Theta) + N \ \Theta / (1+\Theta)$ . For this fleet,  $\Theta = 3.034$  and the sample size multiplier is approximately  $\Theta / (1+\Theta) = 0.752$ .\*

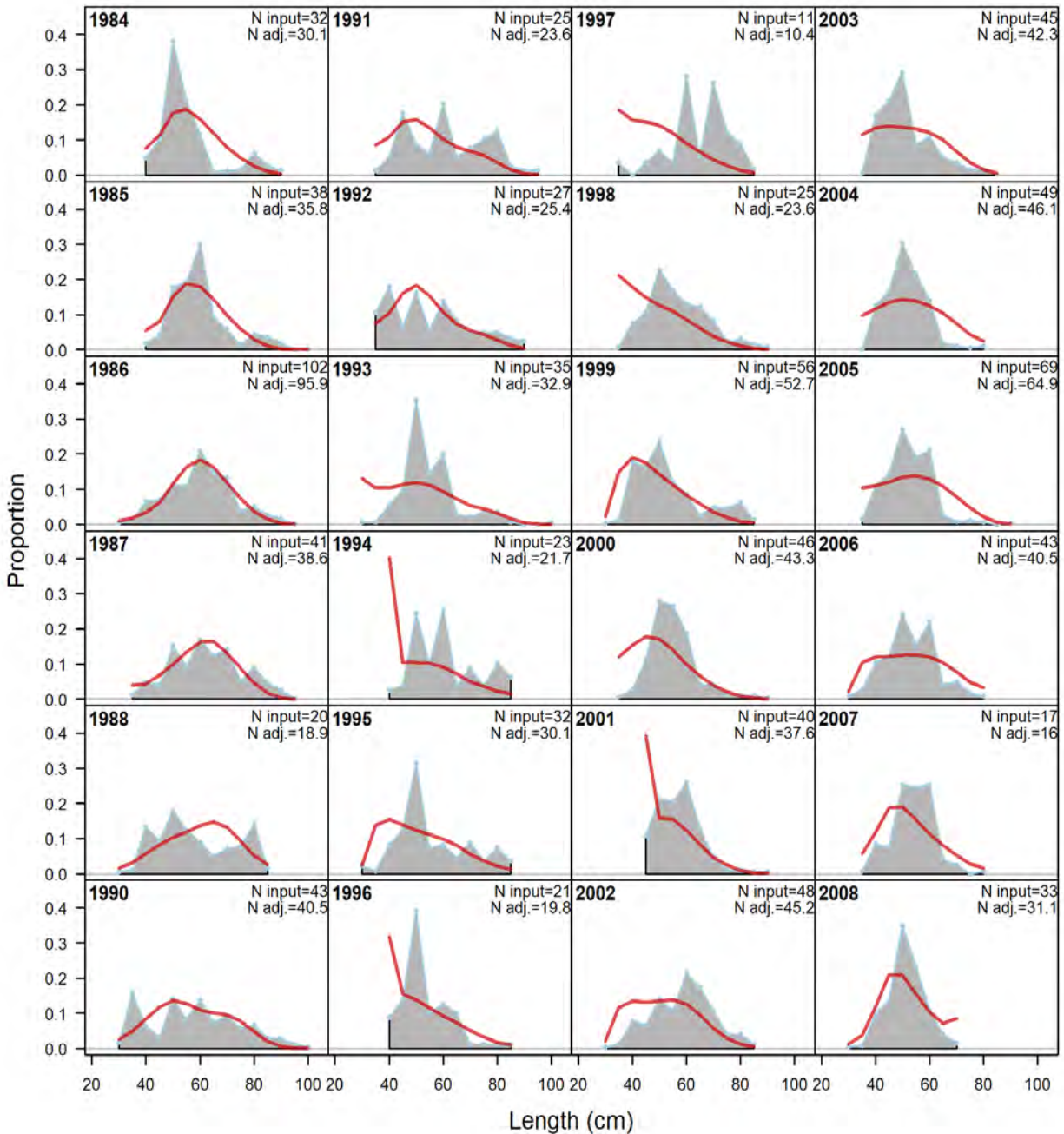


Figure 21. Length compositions, retained, Commercial Longline East. 'N input' is the input sample size. 'N adj.' is the sample size after adjustment by the Dirichlet-Multinomial  $\Theta$  parameter based on the formula  $N \text{ adj.} = 1 / (1 + \Theta) + N \Theta / (1 + \Theta)$ . For this fleet,  $\Theta = 57.973$  and the sample size multiplier is approximately  $\Theta / (1 + \Theta) = 0.983$ .\*



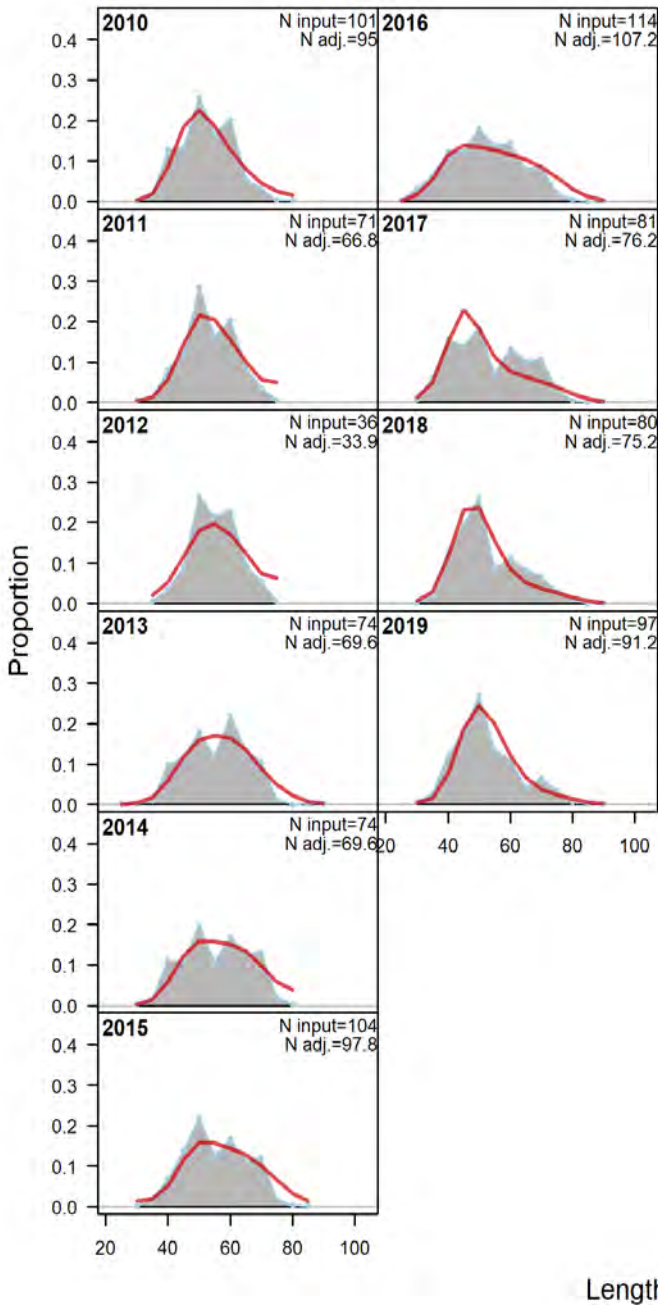


Figure 21 Continued. Length compositions, retained, Commercial Longline East. 'N input' is the input sample size. 'N adj.' is the sample size after adjustment by the Dirichlet-Multinomial  $\Theta$  parameter based on the formula  $N \text{ adj.} = 1 / (1 + \Theta) + N \Theta / (1 + \Theta)$ . For this fleet,  $\Theta = 57.973$  and the sample size multiplier is approximately  $\Theta / (1 + \Theta) = 0.983$ .\*

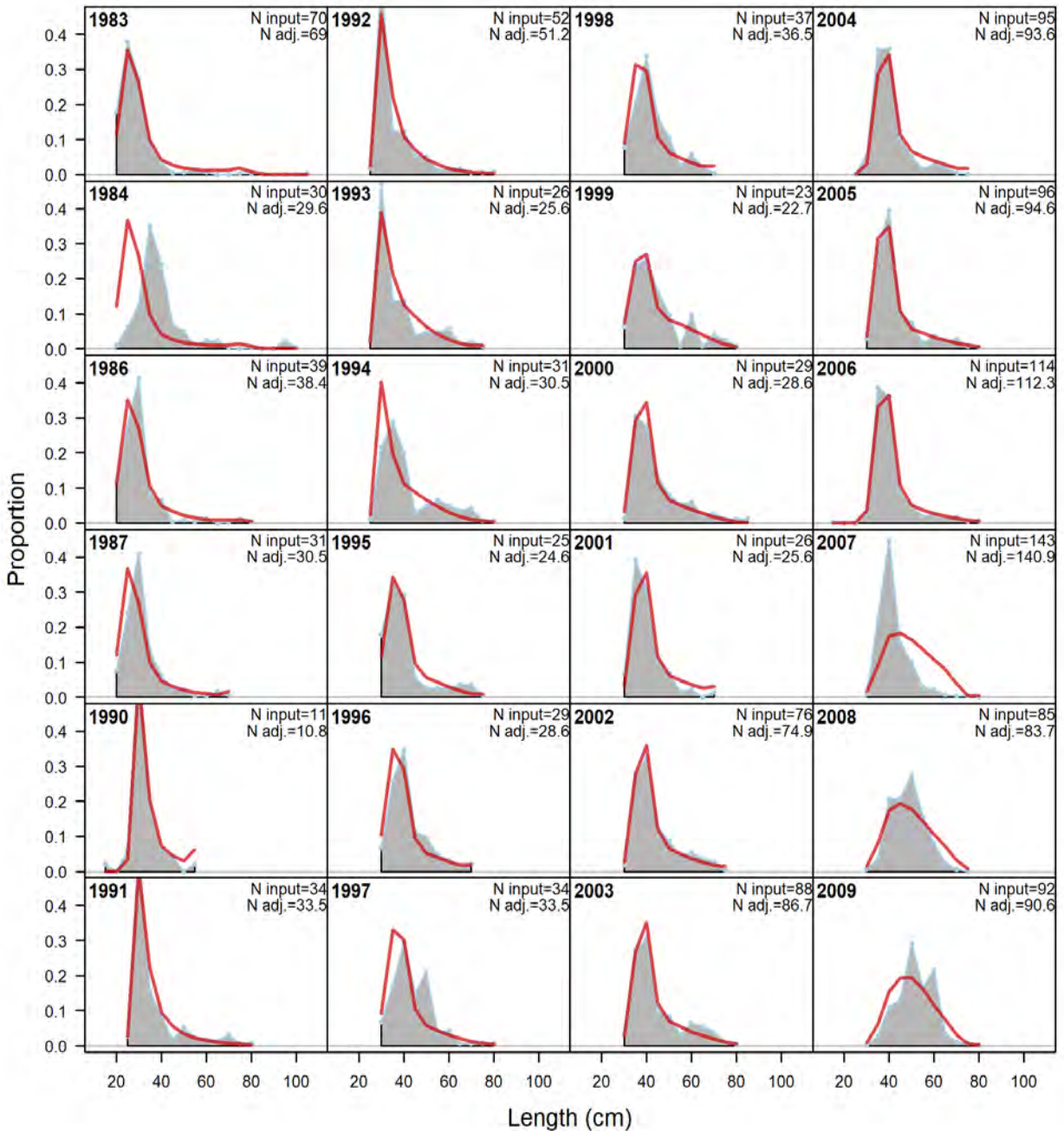


Figure 22. Length compositions, retained, Recreational Charter West. 'N input' is the input sample size. 'N adj.' is the sample size after adjustment by the Dirichlet-Multinomial  $\Theta$  parameter based on the formula  $N \text{ adj.} = 1 / (1 + \Theta) + N \Theta / (1 + \Theta)$ . For this fleet,  $\Theta = 132.445$  and the sample size multiplier is approximately  $\Theta / (1 + \Theta) = 0.993$ .\*

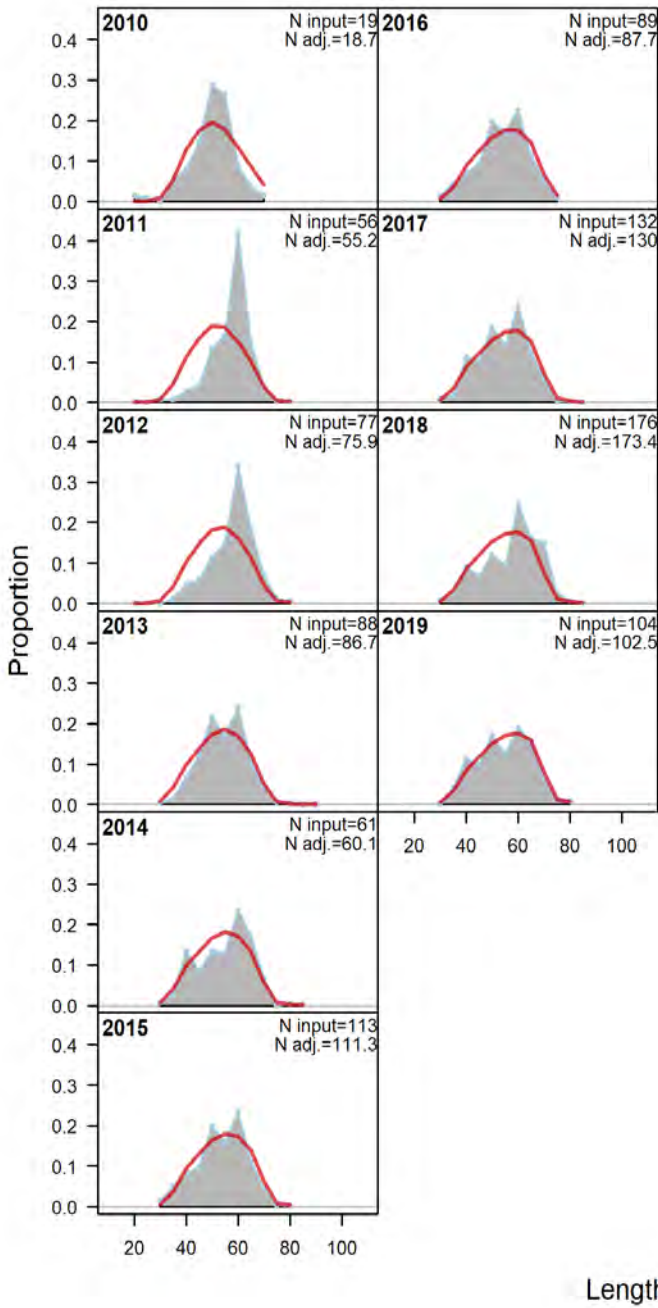


Figure 22 Continued. Length compositions, retained, Recreational Charter West. 'N input' is the input sample size. 'N adj.' is the sample size after adjustment by the Dirichlet-Multinomial  $\Theta$  parameter based on the formula  $N \text{ adj.} = 1 / (1 + \Theta) + N \Theta / (1 + \Theta)$ . For this fleet,  $\Theta = 132.445$  and the sample size multiplier is approximately  $\Theta / (1 + \Theta) = 0.993$ .\*

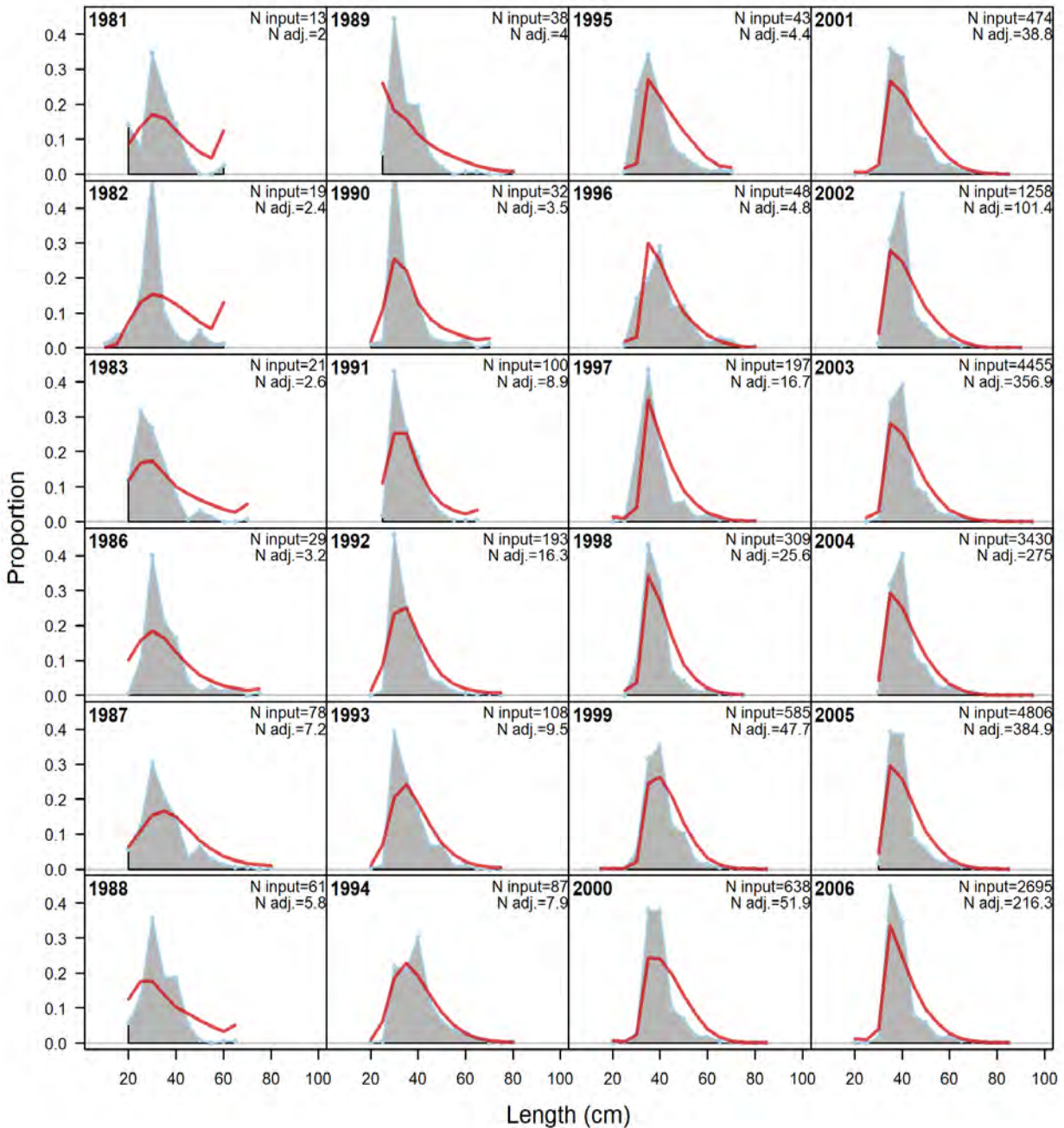


Figure 23. Length compositions, retained, Recreational Charter Central. 'N input' is the input sample size. 'N adj.' is the sample size after adjustment by the Dirichlet-Multinomial  $\Theta$  parameter based on the formula  $N \text{ adj.} = 1 / (1 + \Theta) + N \Theta / (1 + \Theta)$ . For this fleet,  $\Theta = 0.104$  and the sample size multiplier is approximately  $\Theta / (1 + \Theta) = 0.094$ .\*



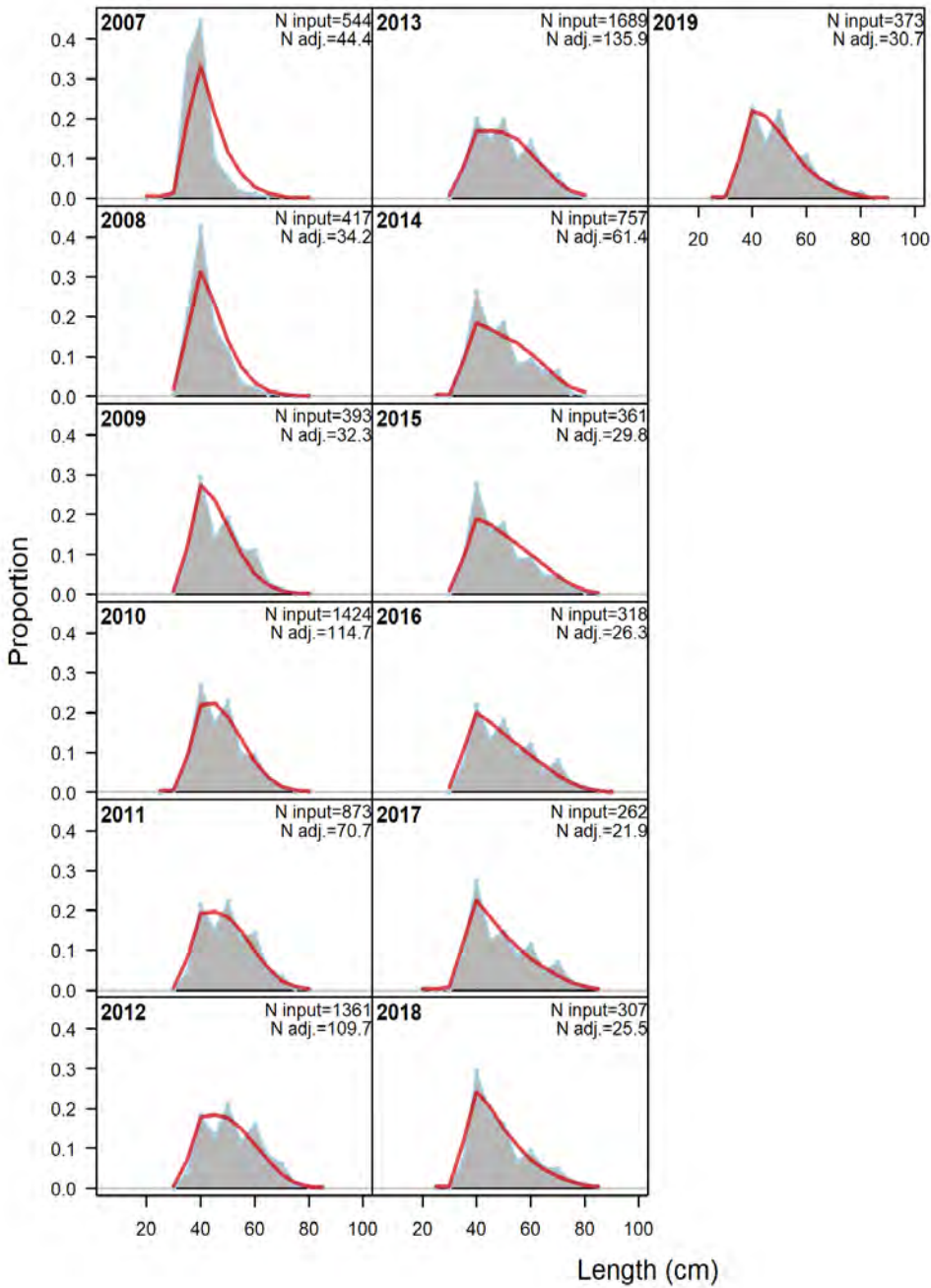


Figure 23 Continued. Length compositions, retained, Recreational Charter Central. 'N input' is the input sample size. 'N adj.' is the sample size after adjustment by the Dirichlet-Multinomial  $\Theta$  parameter based on the formula  $N \text{ adj.} = 1 / (1 + \Theta) + N \Theta / (1 + \Theta)$ . For this fleet,  $\Theta = 0.104$  and the sample size multiplier is approximately  $\Theta / (1 + \Theta) = 0.094$ .\*

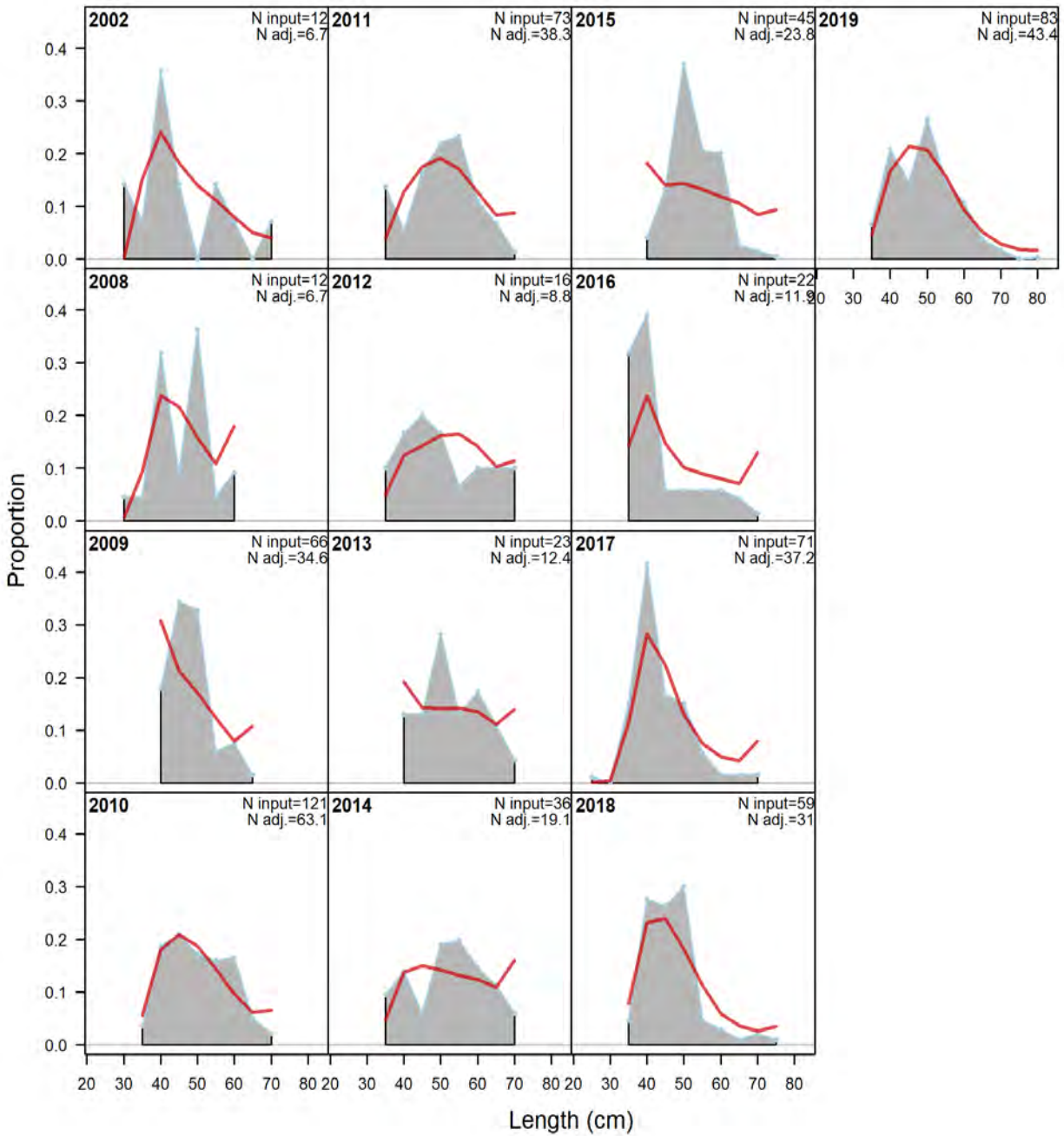


Figure 24. Length compositions, retained, Recreational Charter East. 'N input' is the input sample size. 'N adj.' is the sample size after adjustment by the Dirichlet-Multinomial  $\Theta$  parameter based on the formula  $N \text{ adj.} = 1 / (1 + \Theta) + N \Theta / (1 + \Theta)$ . For this fleet,  $\Theta = 2.43$  and the sample size multiplier is approximately  $\Theta / (1 + \Theta) = 0.708$ .\*

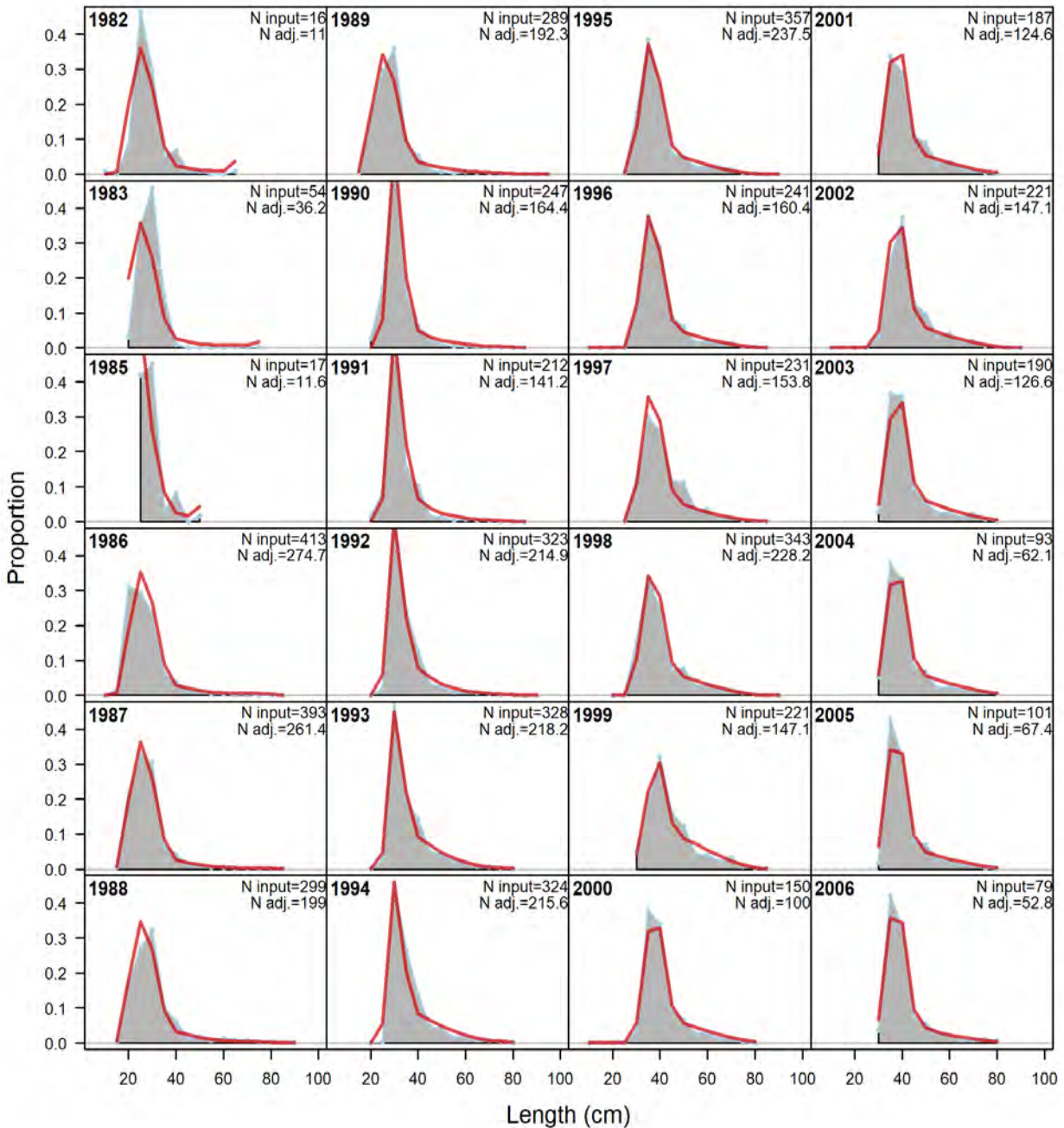


Figure 25. Length compositions, retained, Recreational Headboat West. 'N input' is the input sample size. 'N adj.' is the sample size after adjustment by the Dirichlet-Multinomial  $\Theta$  parameter based on the formula  $N \text{ adj.} = 1 / (1 + \Theta) + N \Theta / (1 + \Theta)$ . For this fleet,  $\Theta = 1.092$  and the sample size multiplier is approximately  $\Theta / (1 + \Theta) = 0.522$ .\*

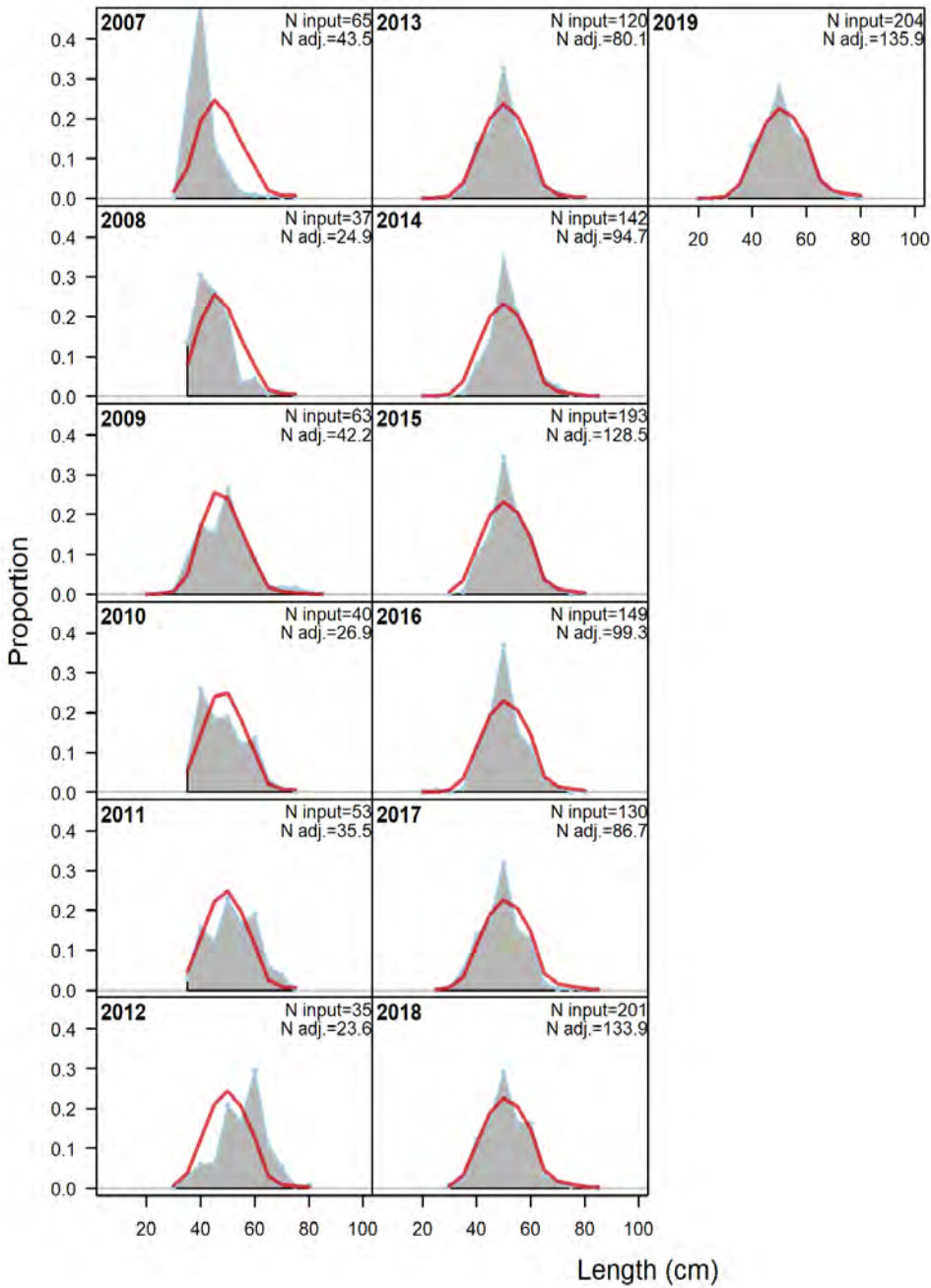


Figure 25 Continued. Length compositions, retained, Recreational Headboat West. ‘N input’ is the input sample size. ‘N adj.’ is the sample size after adjustment by the Dirichlet-Multinomial  $\Theta$  parameter based on the formula  $N \text{ adj.} = 1 / (1 + \Theta) + N \Theta / (1 + \Theta)$ . For this fleet,  $\Theta = 1.092$  and the sample size multiplier is approximately  $\Theta / (1 + \Theta) = 0.522$ .\*



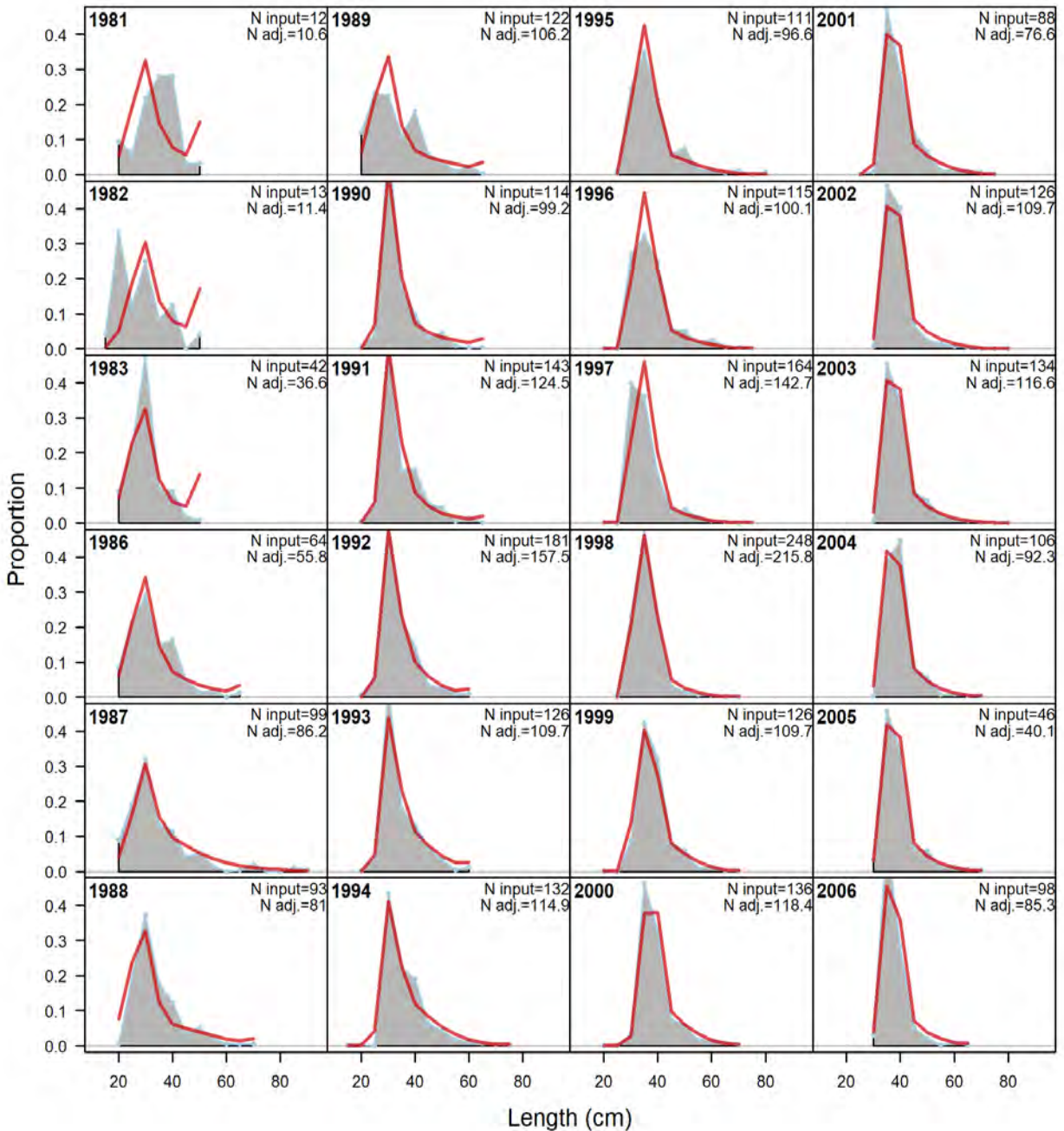


Figure 26. Length compositions, retained, Recreational Headboat Central. 'N input' is the input sample size. 'N adj.' is the sample size after adjustment by the Dirichlet-Multinomial  $\Theta$  parameter based on the formula  $N \text{ adj.} = 1 / (1 + \Theta) + N \Theta / (1 + \Theta)$ . For this fleet,  $\Theta = 0.695$  and the sample size multiplier is approximately  $\Theta / (1 + \Theta) = 0.41$ .\*

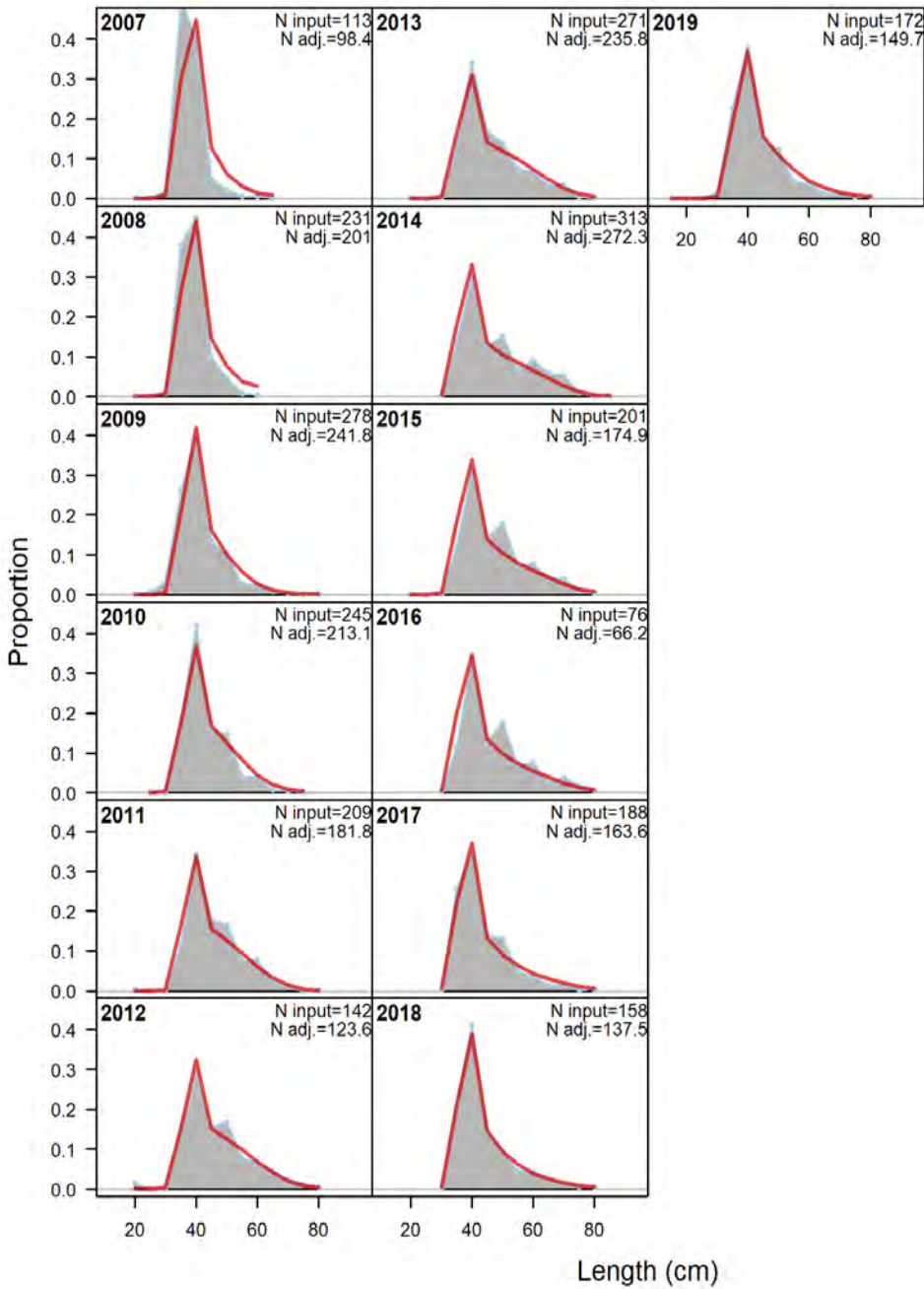


Figure 26 Continued. Length compositions, retained, Recreational Headboat Central. 'N input' is the input sample size. 'N adj.' is the sample size after adjustment by the Dirichlet-Multinomial  $\Theta$  parameter based on the formula  $N \text{ adj.} = 1 / (1 + \Theta) + N \Theta / (1 + \Theta)$ . For this fleet,  $\Theta = 0.695$  and the sample size multiplier is approximately  $\Theta / (1 + \Theta) = 0.41$ .\*

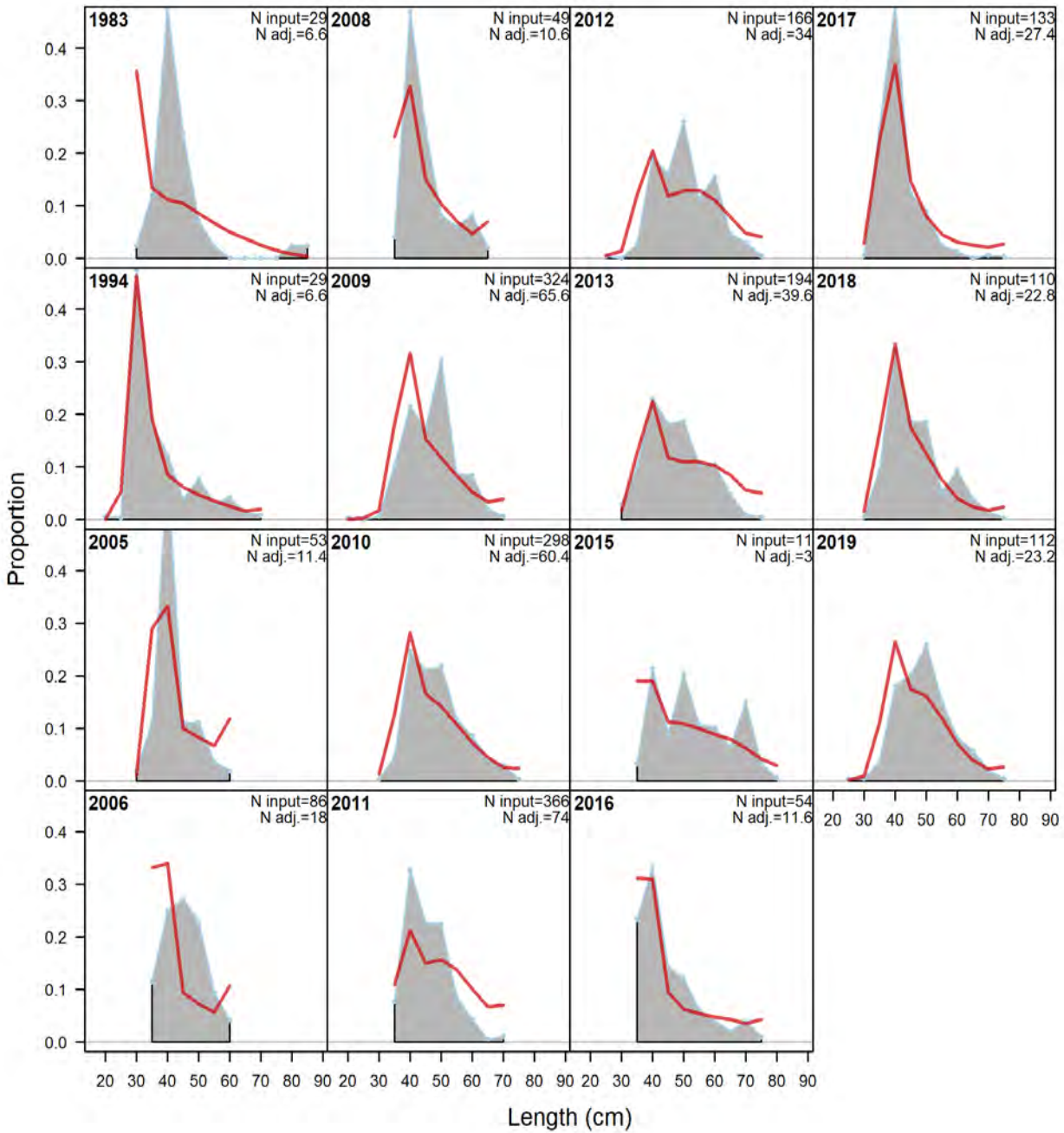


Figure 27. Length compositions, retained, Recreational Headboat East. 'N input' is the input sample size. 'N adj.' is the sample size after adjustment by the Dirichlet-Multinomial  $\Theta$  parameter based on the formula  $N \text{ adj.} = 1 / (1 + \Theta) + N \Theta / (1 + \Theta)$ . For this fleet,  $\Theta = 0.718$  and the sample size multiplier is approximately  $\Theta / (1 + \Theta) = 0.418$ .\*



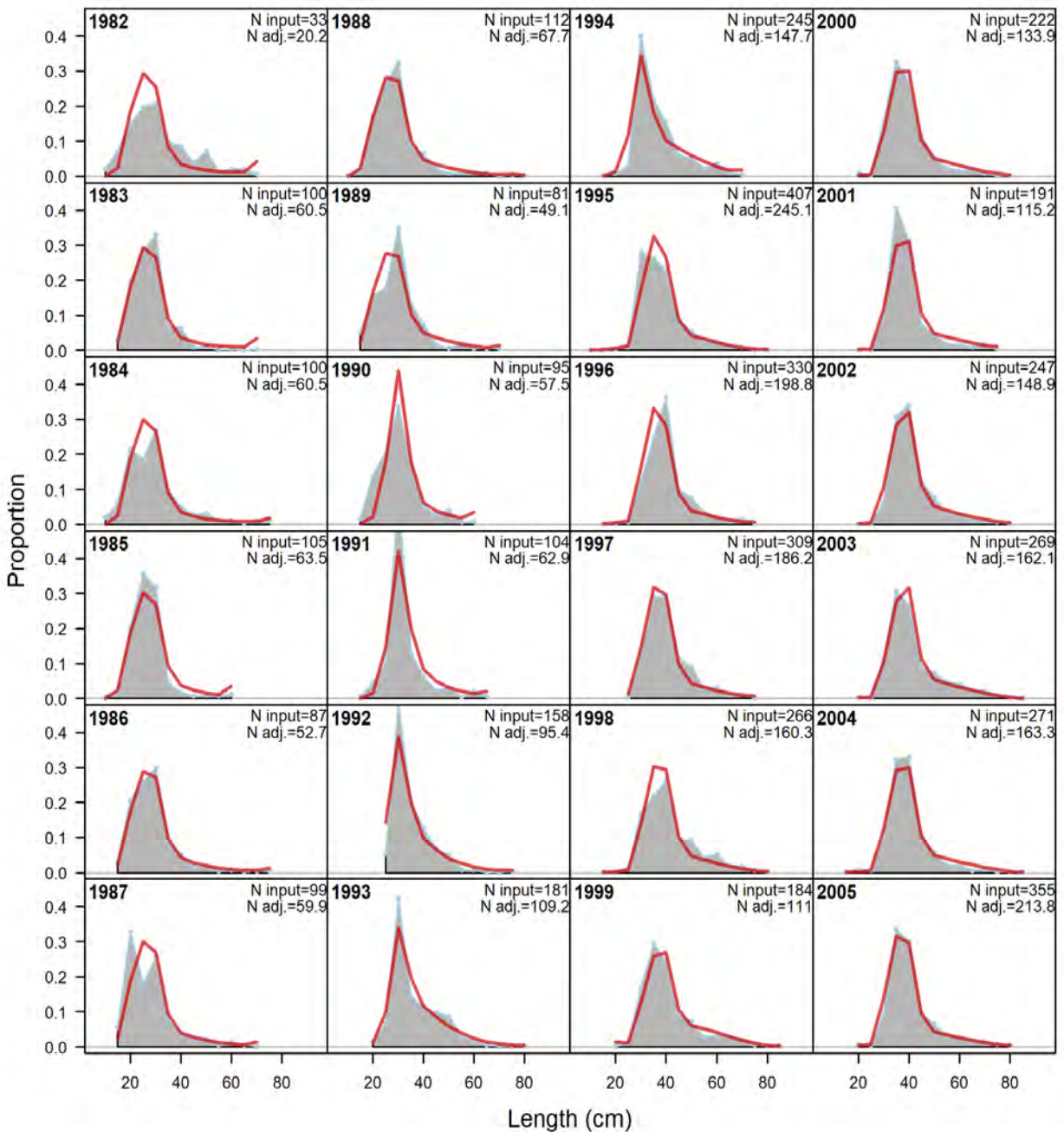


Figure 28. Length compositions, retained, Recreational Private West. 'N input' is the input sample size. 'N adj.' is the sample size after adjustment by the Dirichlet-Multinomial  $\Theta$  parameter based on the formula  $N \text{ adj.} = 1 / (1 + \Theta) + N \Theta / (1 + \Theta)$ . For this fleet,  $\Theta = 1.333$  and the sample size multiplier is approximately  $\Theta / (1 + \Theta) = 0.571$ .\*

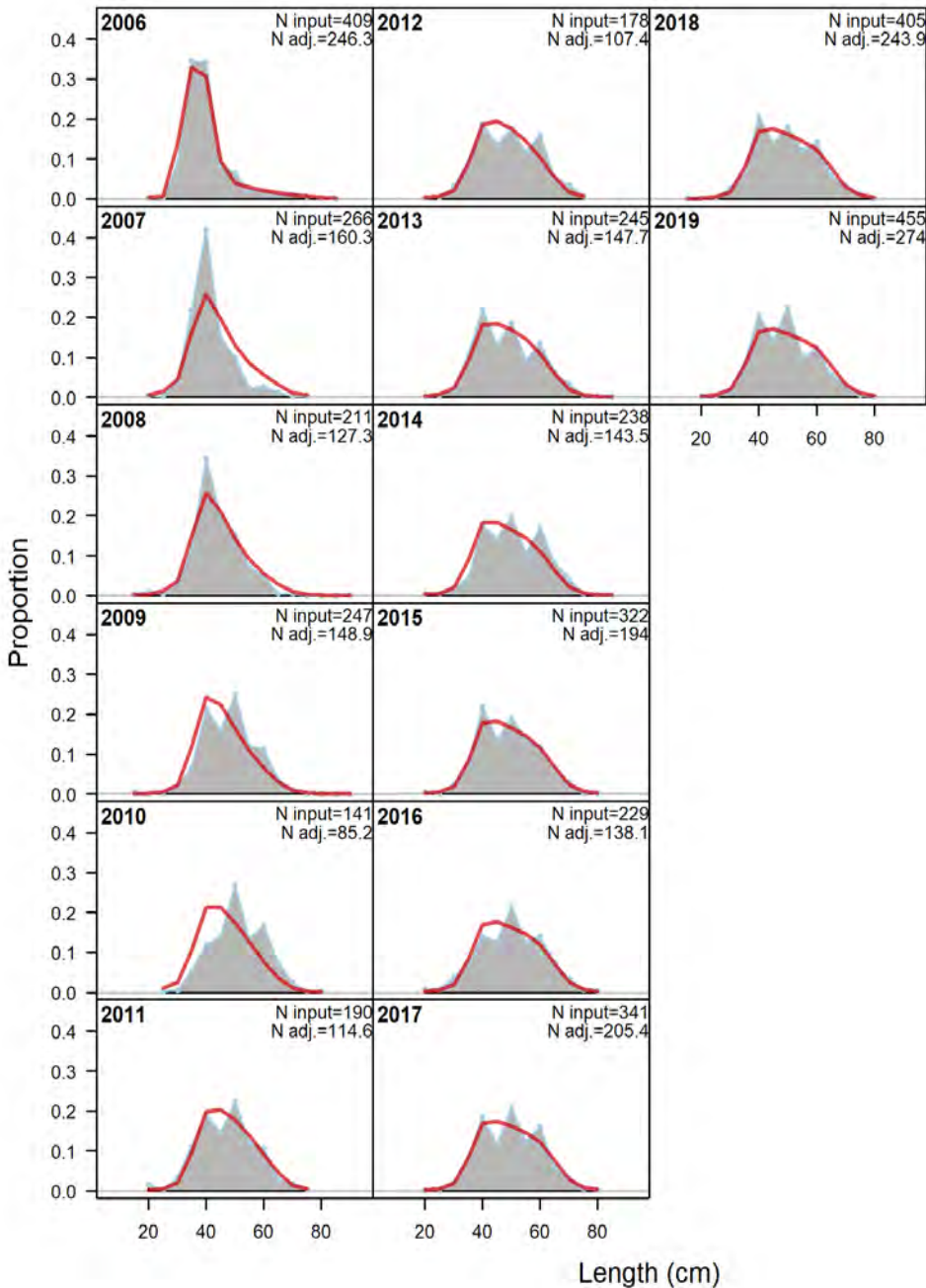


Figure 28 Continued. Length compositions, retained, Recreational Private West. ‘N input’ is the input sample size. ‘N adj.’ is the sample size after adjustment by the Dirichlet-Multinomial  $\Theta$  parameter based on the formula  $N \text{ adj.} = 1 / (1 + \Theta) + N \Theta / (1 + \Theta)$ . For this fleet,  $\Theta = 1.333$  and the sample size multiplier is approximately  $\Theta / (1 + \Theta) = 0.571$ .\*

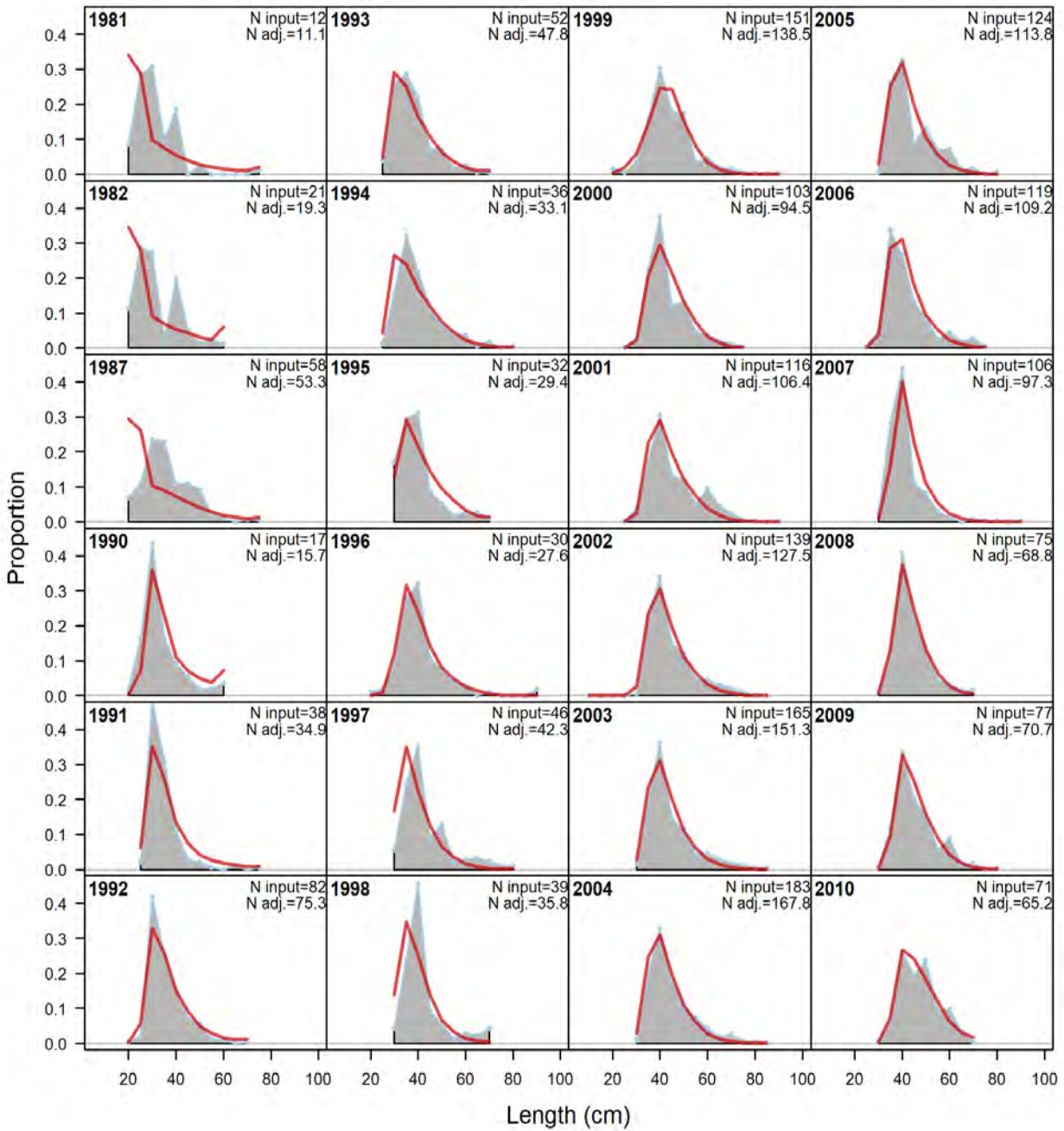


Figure 29. Length compositions, retained, Recreational Private Central. ‘N input’ is the input sample size. ‘N adj.’ is the sample size after adjustment by the Dirichlet-Multinomial  $\Theta$  parameter based on the formula  $N\ adj. = 1 / (1+\Theta) + N \Theta / (1+\Theta)$ . For this fleet,  $\Theta = 67.053$  and the sample size multiplier is approximately  $\Theta / (1+\Theta) = 0.985$ .\*

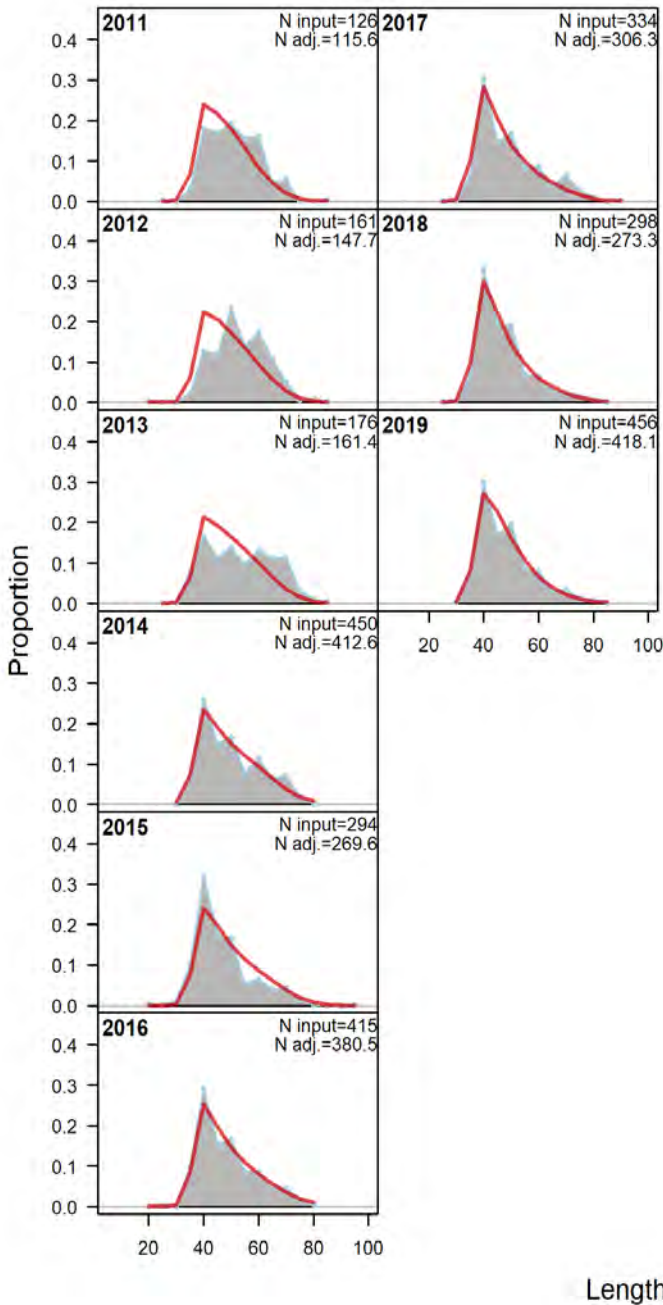


Figure 29 Continued. Length compositions, retained, Recreational Private Central. 'N input' is the input sample size. 'N adj.' is the sample size after adjustment by the Dirichlet-Multinomial  $\Theta$  parameter based on the formula  $N \text{ adj.} = 1 / (1 + \Theta) + N \Theta / (1 + \Theta)$ . For this fleet,  $\Theta = 67.053$  and the sample size multiplier is approximately  $\Theta / (1 + \Theta) = 0.985$ .\*



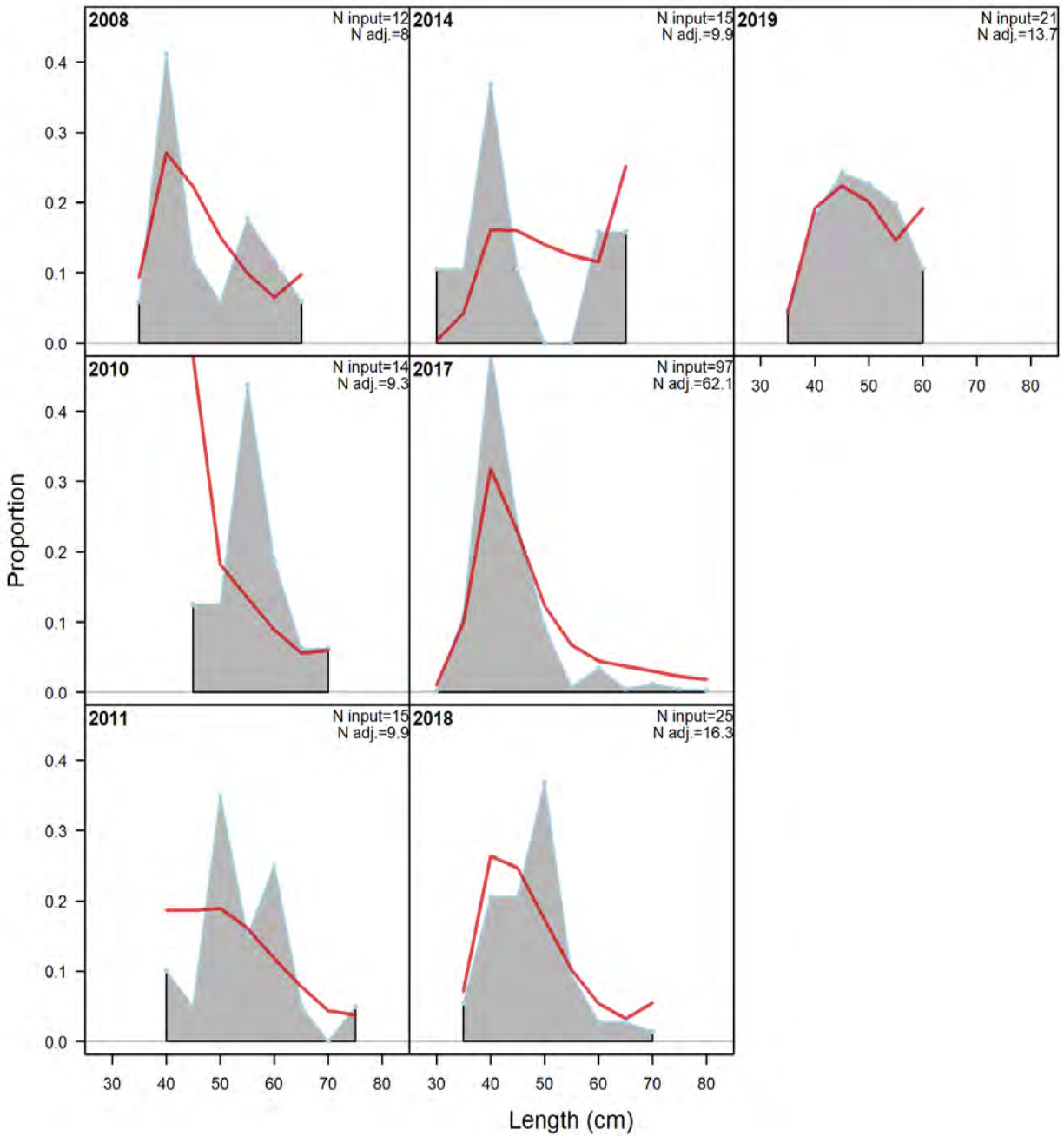


Figure 30. Length compositions, retained, Recreational Private East. 'N input' is the input sample size. 'N adj.' is the sample size after adjustment by the Dirichlet-Multinomial  $\Theta$  parameter based on the formula  $N \text{ adj.} = 1 / (1 + \Theta) + N \Theta / (1 + \Theta)$ . For this fleet,  $\Theta = 2.305$  and the sample size multiplier is approximately  $\Theta / (1 + \Theta) = 0.697$ .\*



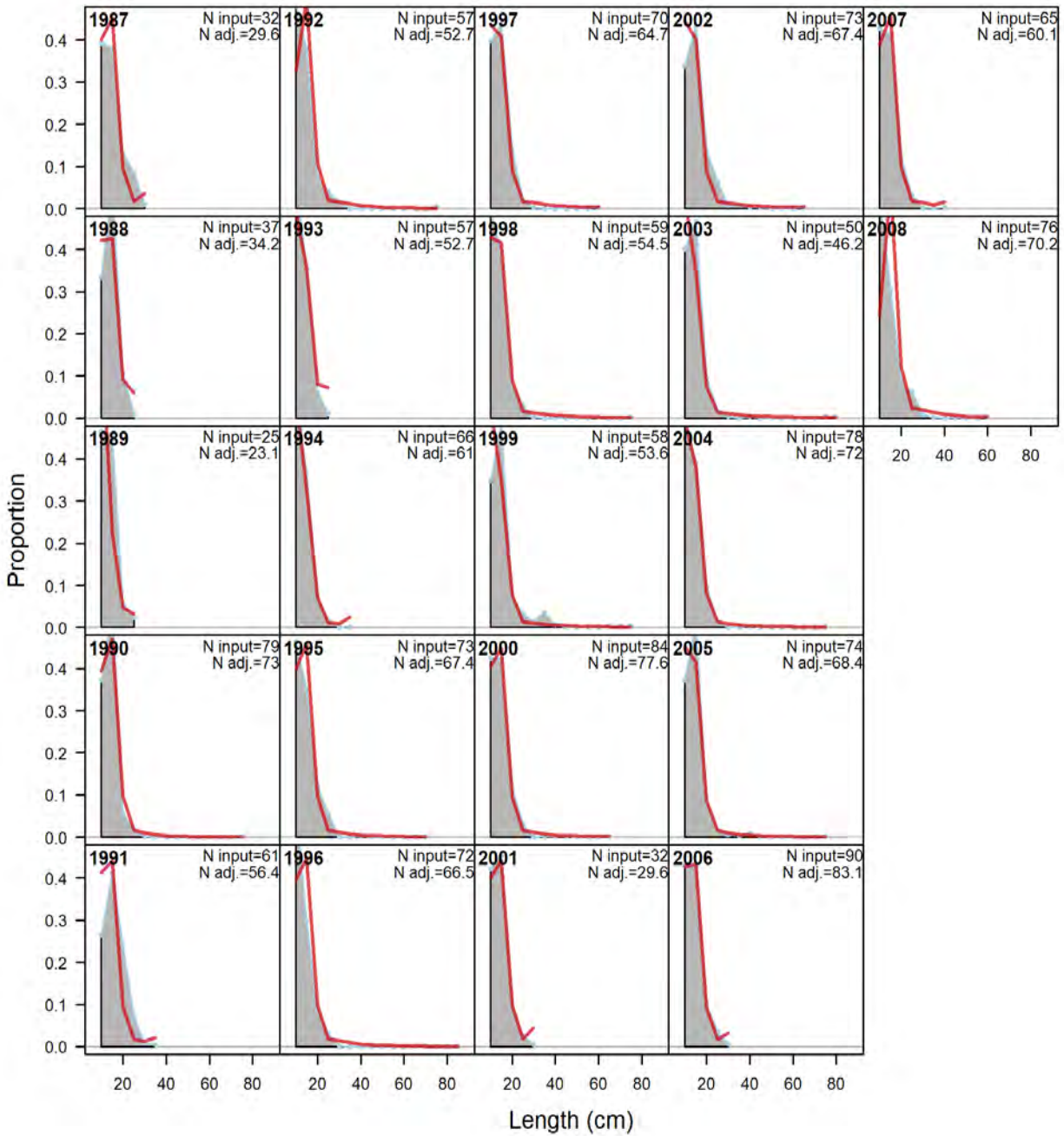


Figure 31. Length compositions, whole catch, SEAMAP Summer Trawl Pre-2007 West. 'N input' is the input sample size. 'N adj.' is the sample size after adjustment by the Dirichlet-Multinomial  $\Theta$  parameter based on the formula  $N \text{ adj.} = 1 / (1 + \Theta) + N \Theta / (1 + \Theta)$ . For this fleet,  $\Theta = 4.972$  and the sample size multiplier is approximately  $\Theta / (1 + \Theta) = 0.833$ .\*

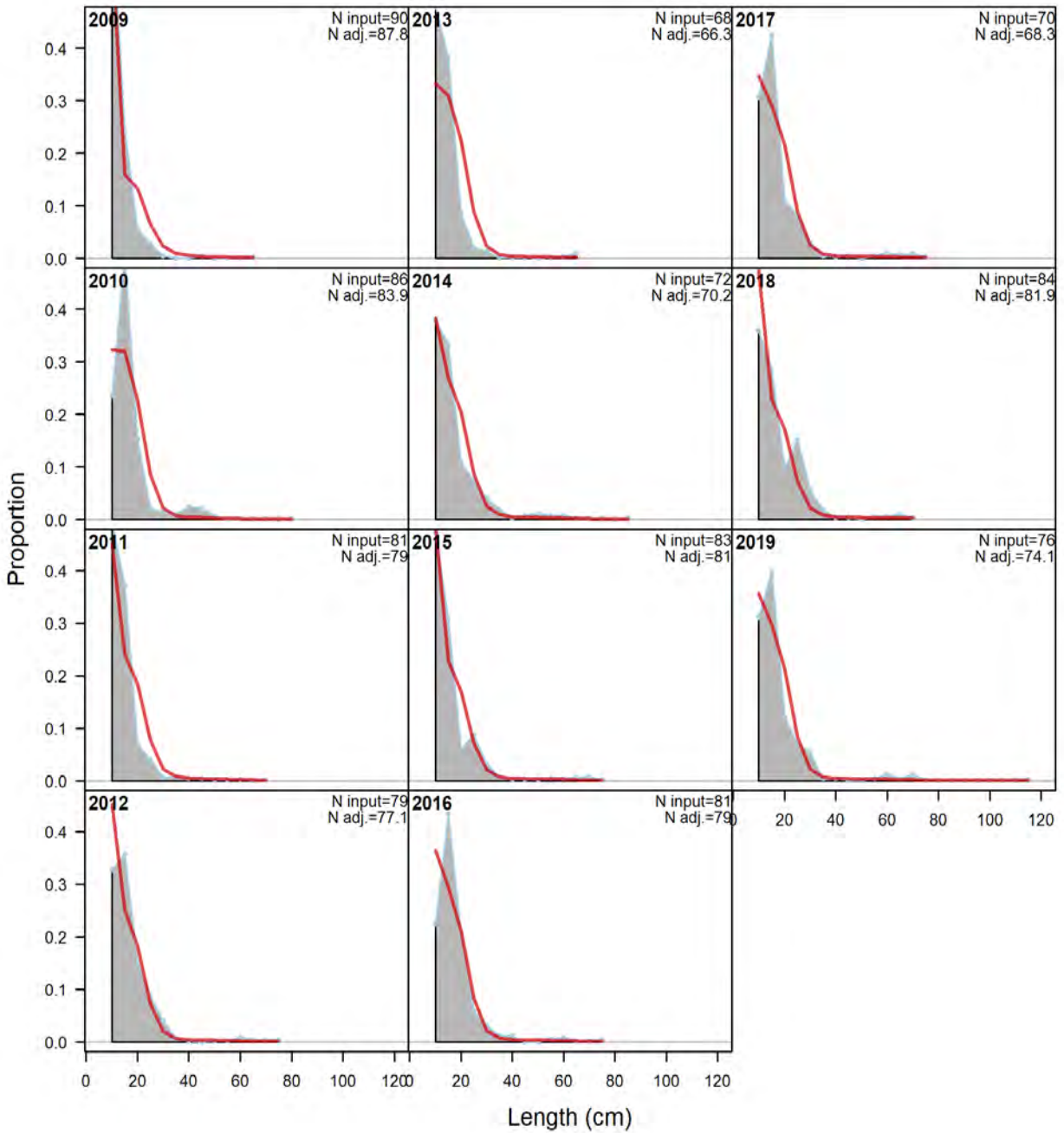


Figure 32. Length compositions, whole catch, SEAMAP Summer Trawl Post-2007 West.

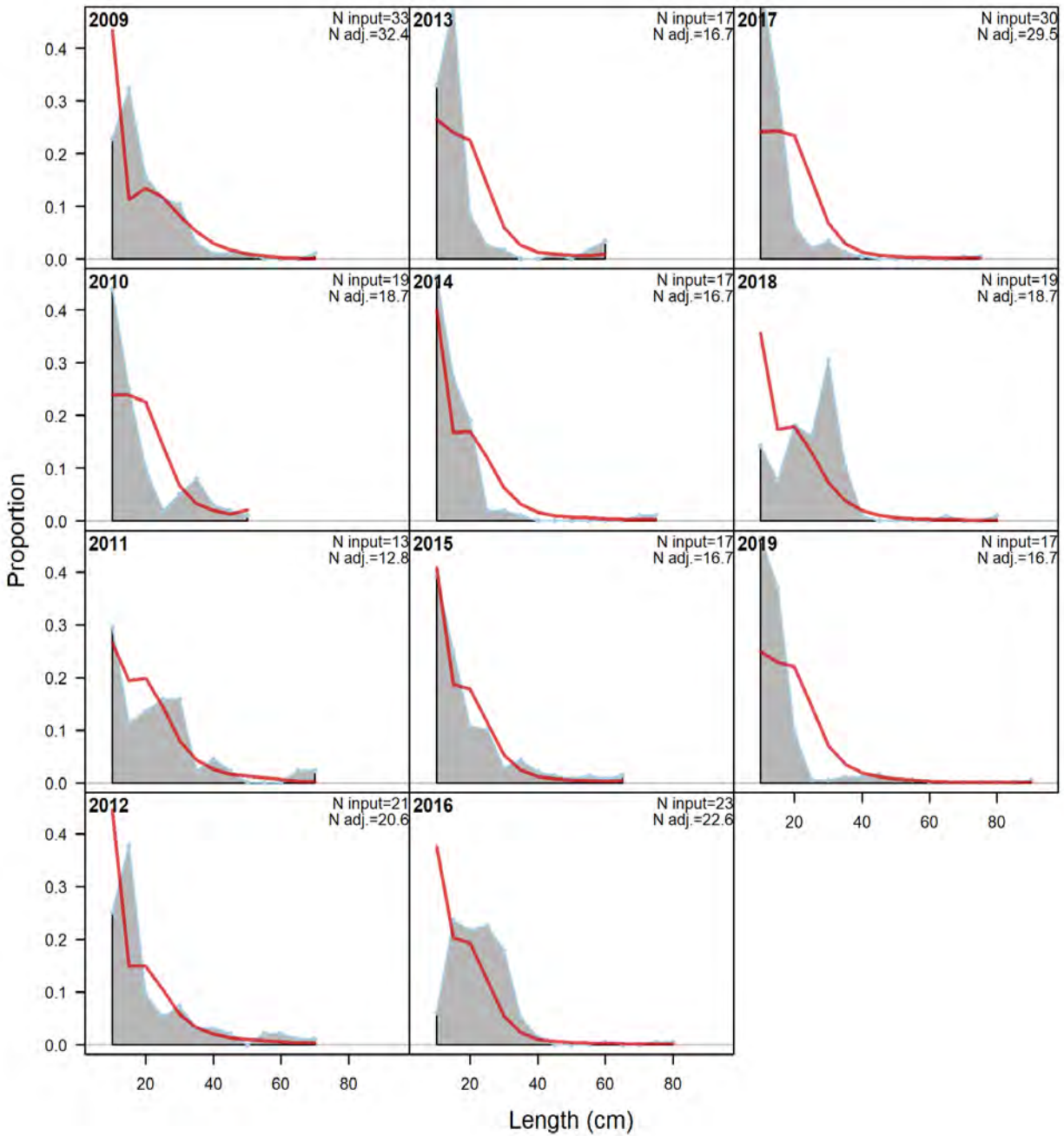


Figure 33. Length compositions, whole catch, SEAMAP Summer Trawl Post-2007 Central. 'N input' is the input sample size. 'N adj.' is the sample size after adjustment by the Dirichlet-Multinomial  $\Theta$  parameter based on the formula  $N \text{ adj.} = 1 / (1 + \Theta) + N \Theta / (1 + \Theta)$ . For this fleet,  $\Theta = 32.672$  and the sample size multiplier is approximately  $\Theta / (1 + \Theta) = 0.97$ .\*

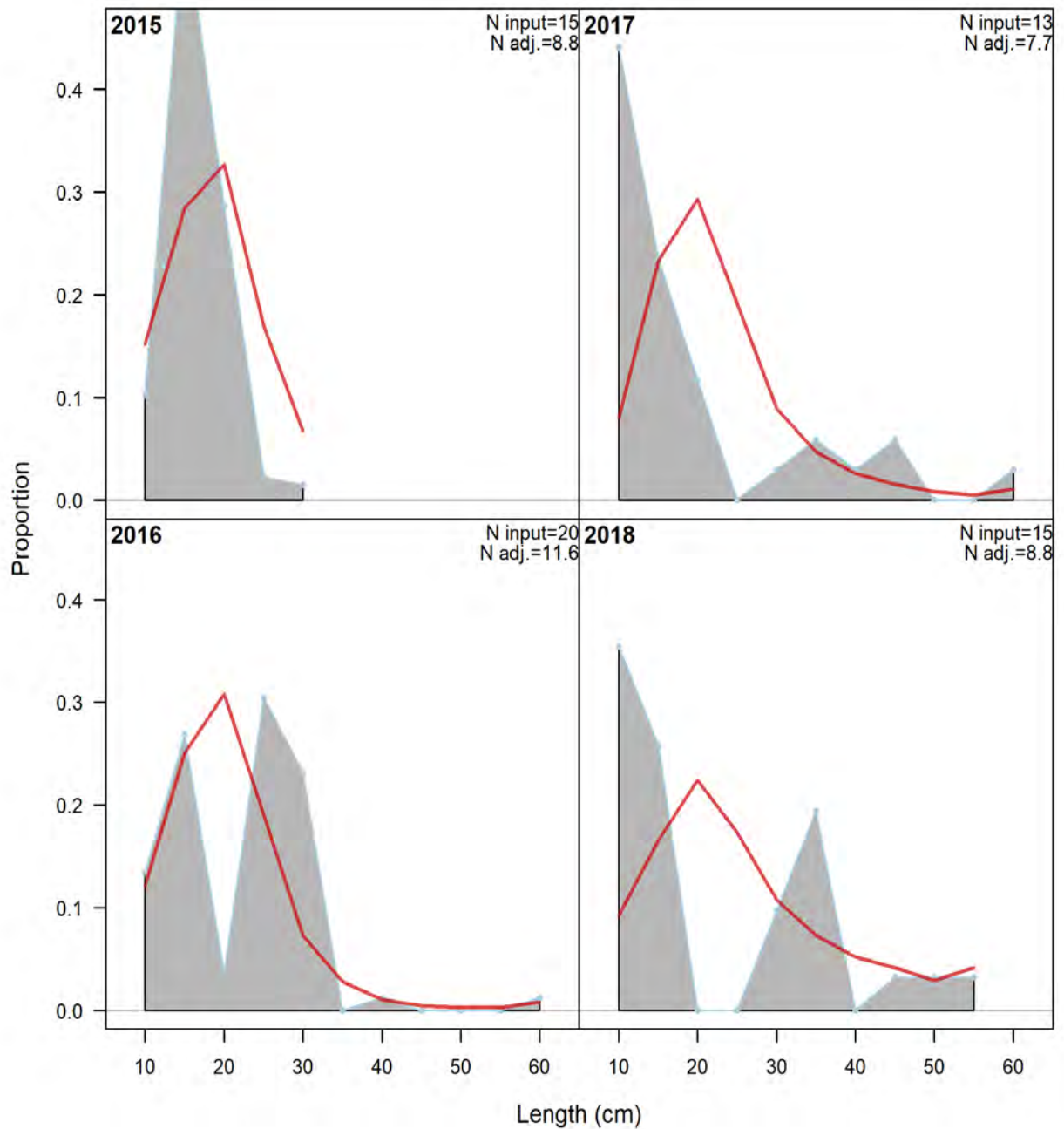


Figure 34. Length compositions, whole catch, SEAMAP Summer Trawl Post-2007 East. ‘N input’ is the input sample size. ‘N adj.’ is the sample size after adjustment by the Dirichlet-Multinomial  $\Theta$  parameter based on the formula  $N \text{ adj.} = 1 / (1 + \Theta) + N \Theta / (1 + \Theta)$ . For this fleet,  $\Theta = 1.581$  and the sample size multiplier is approximately  $\Theta / (1 + \Theta) = 0.613$ .\*



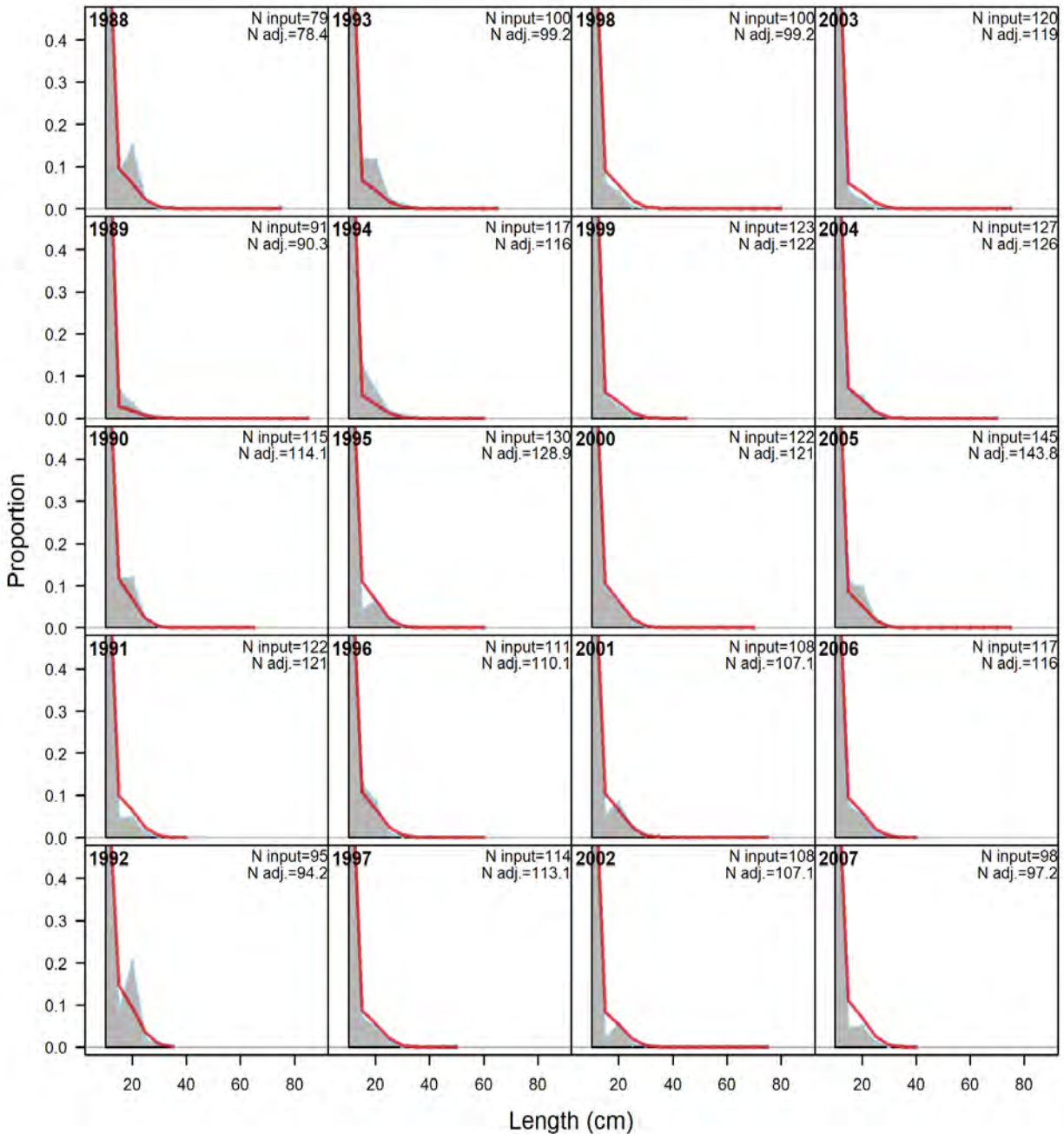


Figure 35. Length compositions, whole catch, SEAMAP Fall Trawl Pre-2007 West. 'N input' is the input sample size. 'N adj.' is the sample size after adjustment by the Dirichlet-Multinomial  $\Theta$  parameter based on the formula  $N \text{ adj.} = 1 / (1 + \Theta) + N \Theta / (1 + \Theta)$ . For this fleet,  $\Theta = 117.117$  and the sample size multiplier is approximately  $\Theta / (1 + \Theta) = 0.992$ .\*

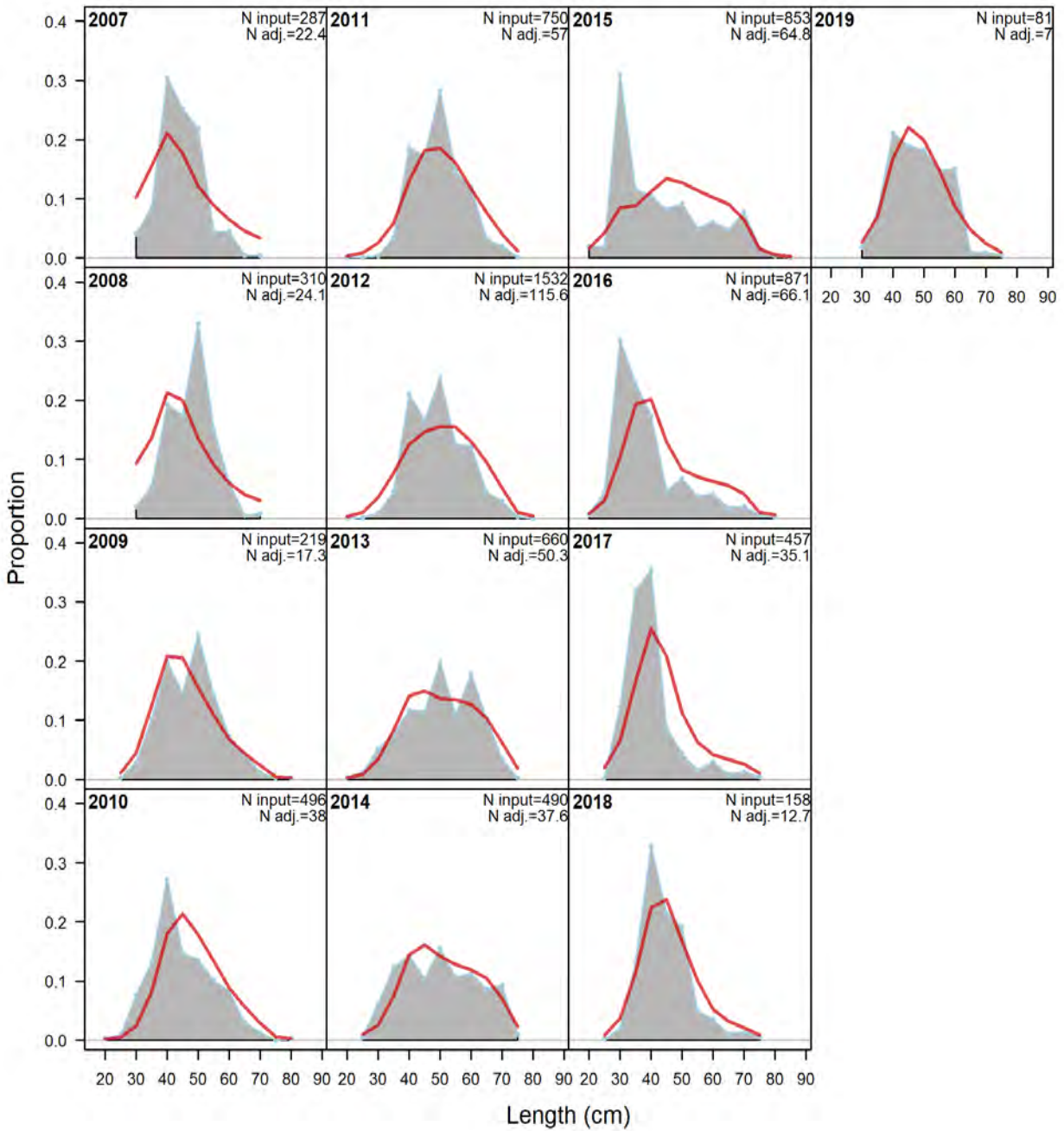


Figure 36. Length compositions, whole catch, Commercial Observer Program East. 'N input' is the input sample size. 'N adj.' is the sample size after adjustment by the Dirichlet-Multinomial  $\Theta$  parameter based on the formula  $N \text{ adj.} = 1 / (1 + \Theta) + N \Theta / (1 + \Theta)$ . For this fleet,  $\Theta = 0.083$  and the sample size multiplier is approximately  $\Theta / (1 + \Theta) = 0.077$ .\*

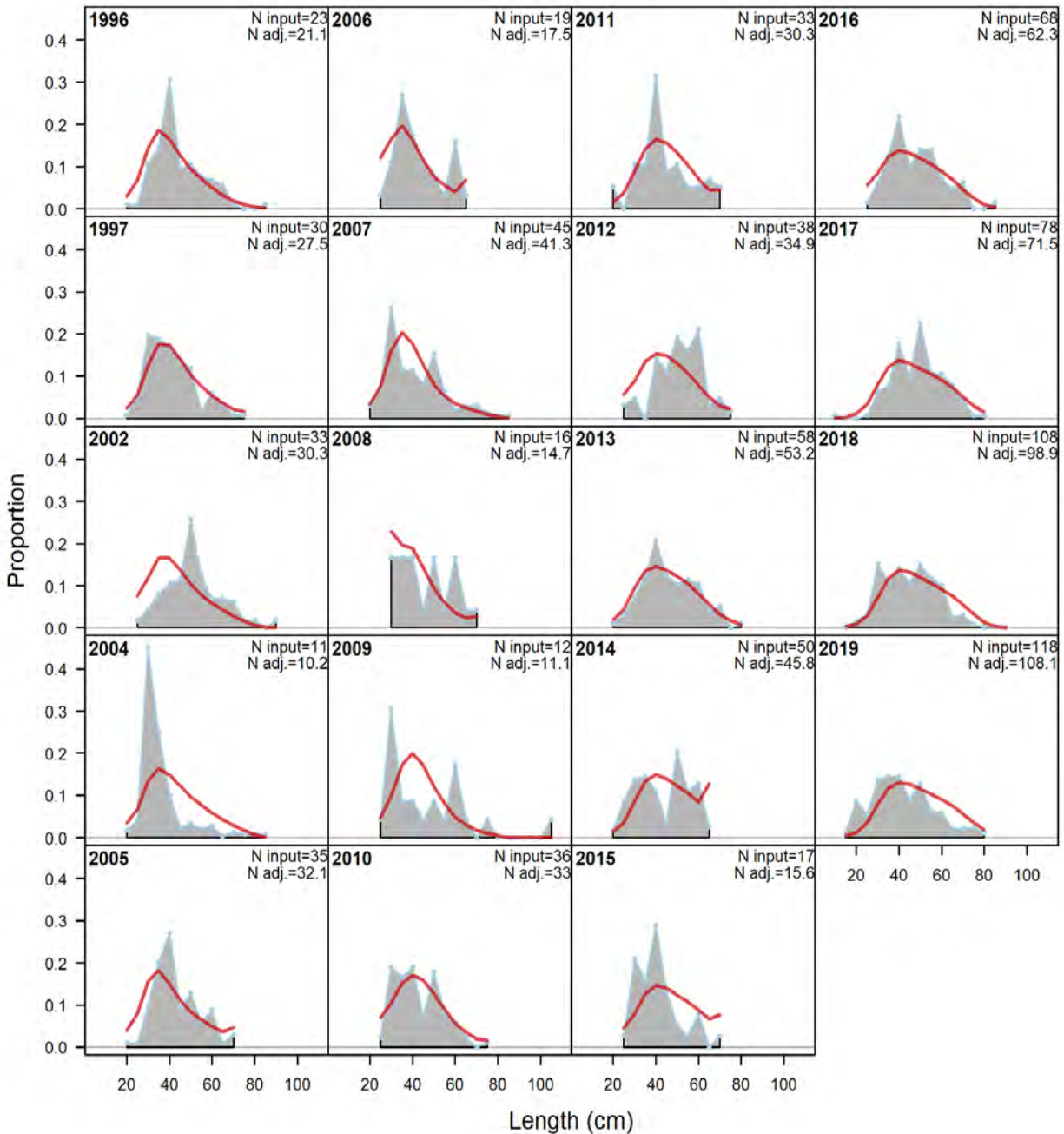


Figure 37. Length compositions, whole catch, SEAMAP Video Survey West. ‘N input’ is the input sample size. ‘N adj.’ is the sample size after adjustment by the Dirichlet-Multinomial  $\Theta$  parameter based on the formula  $N\ adj. = 1 / (1+\Theta) + N \Theta / (1+\Theta)$ . For this fleet,  $\Theta = 7.024$  and the sample size multiplier is approximately  $\Theta / (1+\Theta) = 0.875$ .\*

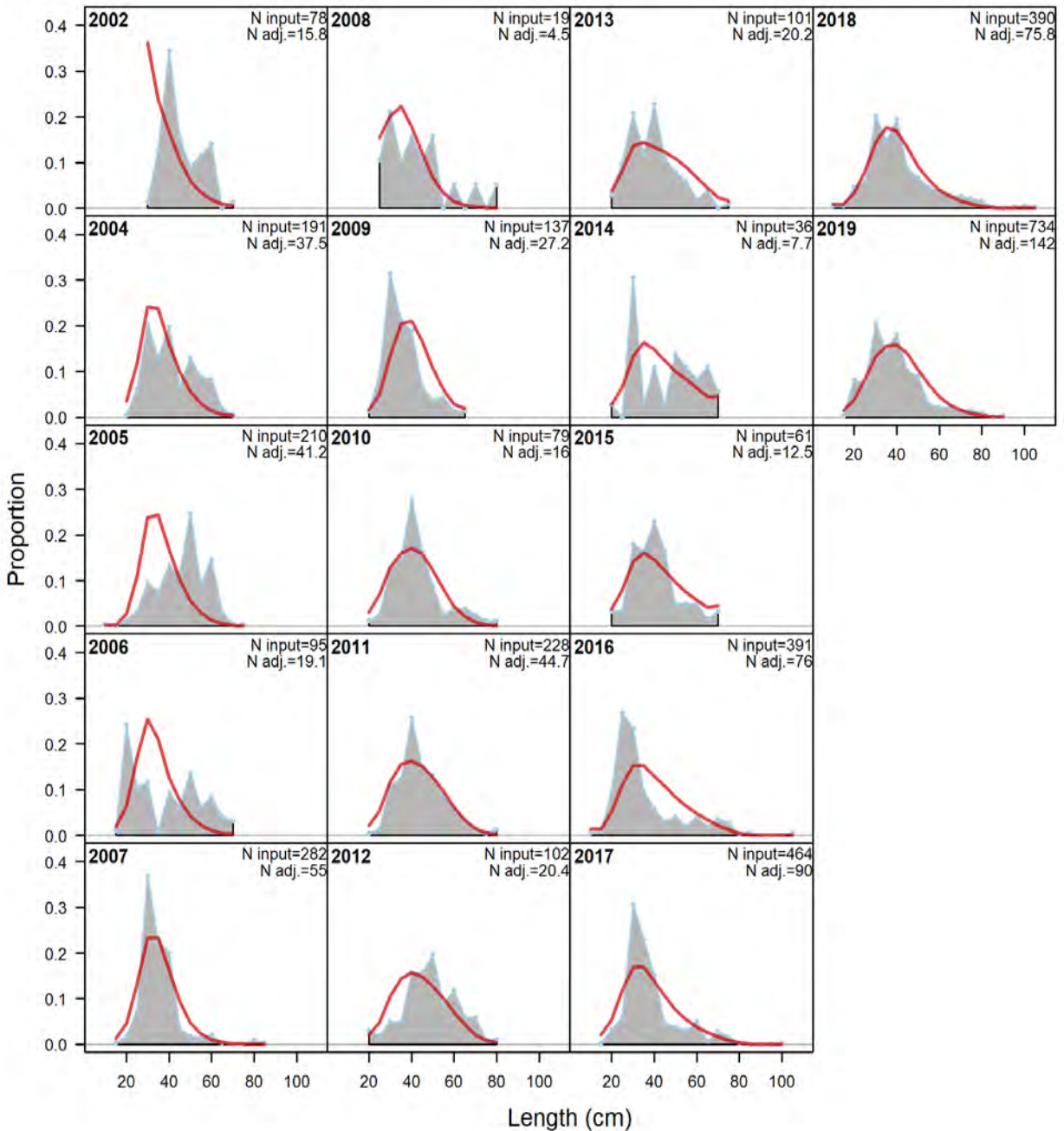


Figure 38. Length compositions, whole catch, Combined Video Survey Central (G-FISHER). 'N input' is the input sample size. 'N adj.' is the sample size after adjustment by the Dirichlet-Multinomial  $\Theta$  parameter based on the formula  $N_{adj.} = 1 / (1 + \Theta) + N \Theta / (1 + \Theta)$ . For this fleet,  $\Theta = 0.236$  and the sample size multiplier is approximately  $\Theta / (1 + \Theta) = 0.191$ .\*



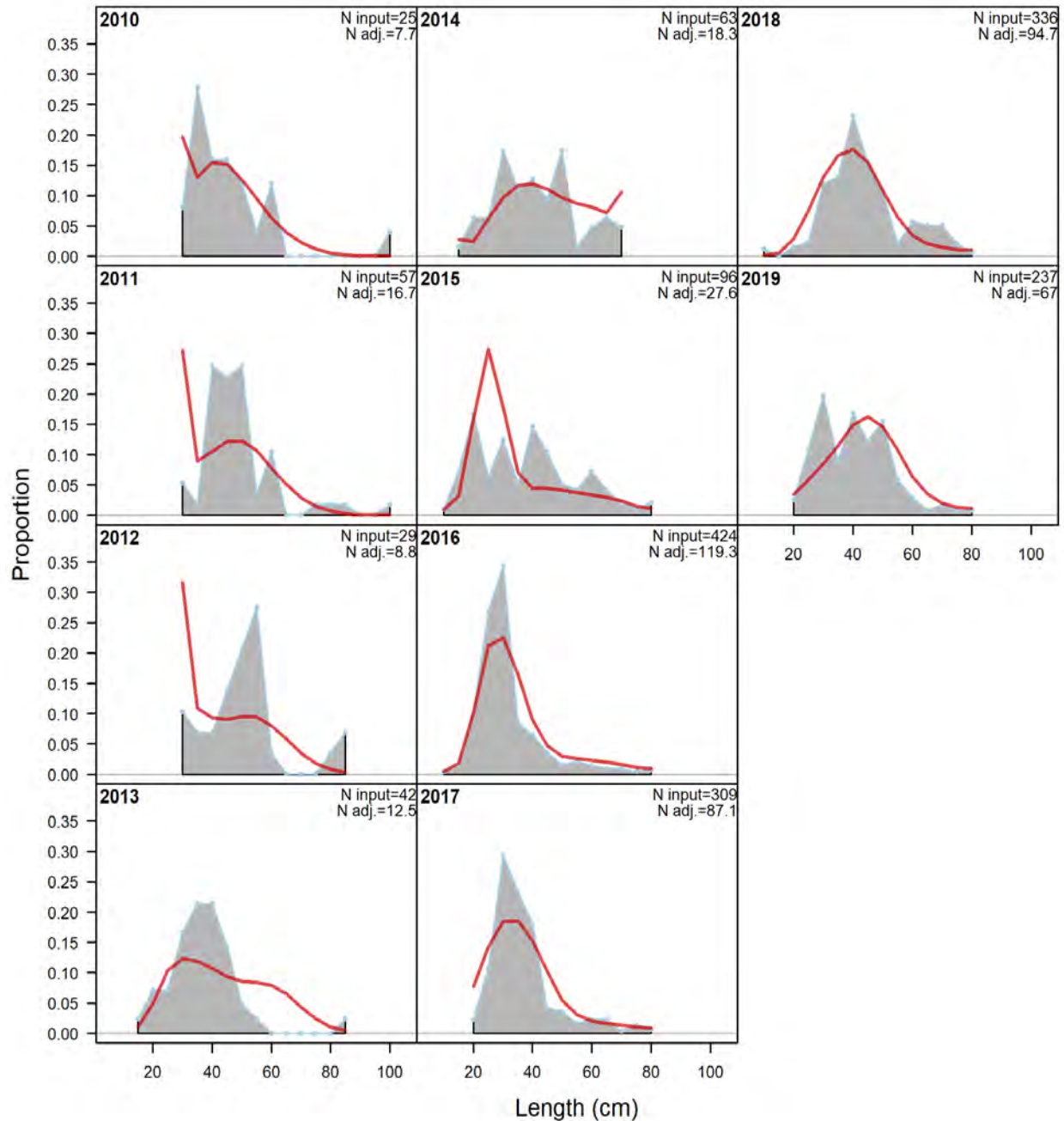


Figure 39. Length compositions, whole catch, Combined Video Survey East (G-FISHER). 'N input' is the input sample size. 'N adj.' is the sample size after adjustment by the Dirichlet-Multinomial  $\Theta$  parameter based on the formula  $N \text{ adj.} = 1 / (1 + \Theta) + N \Theta / (1 + \Theta)$ . For this fleet,  $\Theta = 0.376$  and the sample size multiplier is approximately  $\Theta / (1 + \Theta) = 0.273$ .\*

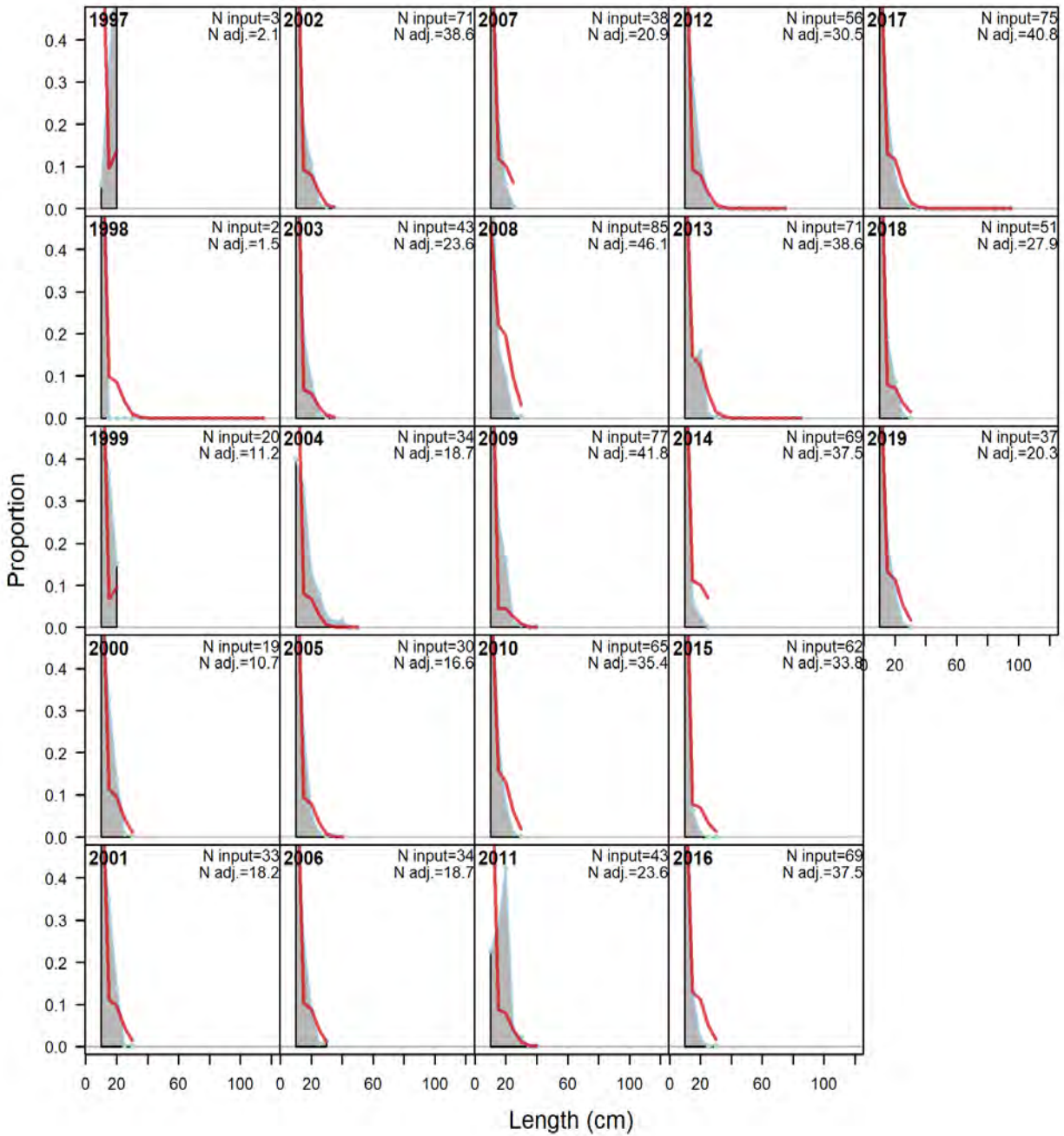


Figure 40. Length compositions, discard, Shrimp Bycatch West. 'N input' is the input sample size. 'N adj.' is the sample size after adjustment by the Dirichlet-Multinomial  $\Theta$  parameter based on the formula  $N\ adj. = 1 / (1+\Theta) + N \Theta / (1+\Theta)$ . For this fleet,  $\Theta = 69.402$  and the sample size multiplier is approximately  $\Theta / (1+\Theta) = 0.986$ .\*

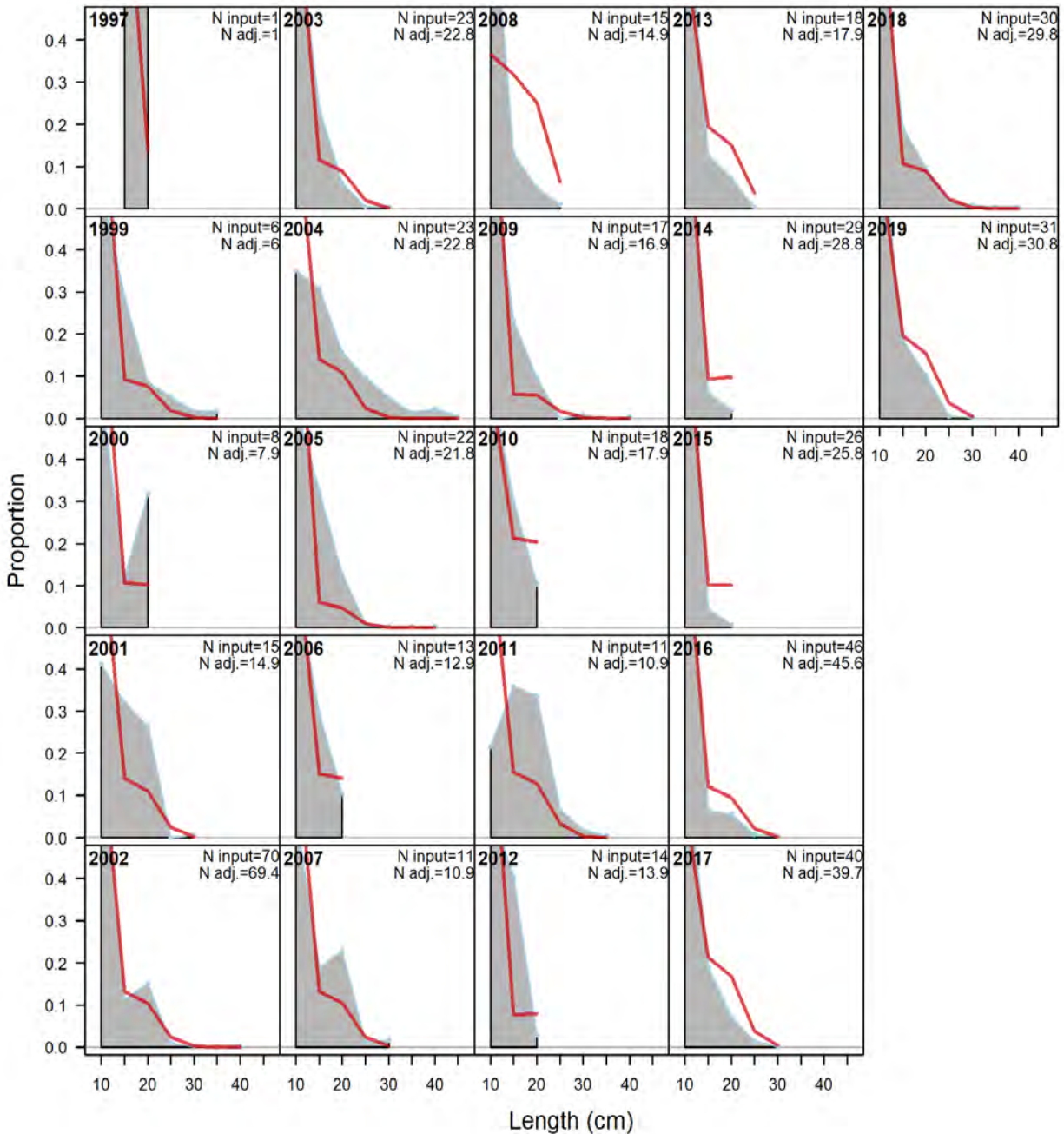


Figure 41. Length compositions, discard, Shrimp Bycatch Central. 'N input' is the input sample size. 'N adj.' is the sample size after adjustment by the Dirichlet-Multinomial  $\Theta$  parameter based on the formula  $N \text{ adj.} = 1 / (1 + \Theta) + N \Theta / (1 + \Theta)$ . For this fleet,  $\Theta = 121.52$  and the sample size multiplier is approximately  $\Theta / (1 + \Theta) = 0.992$ .\*

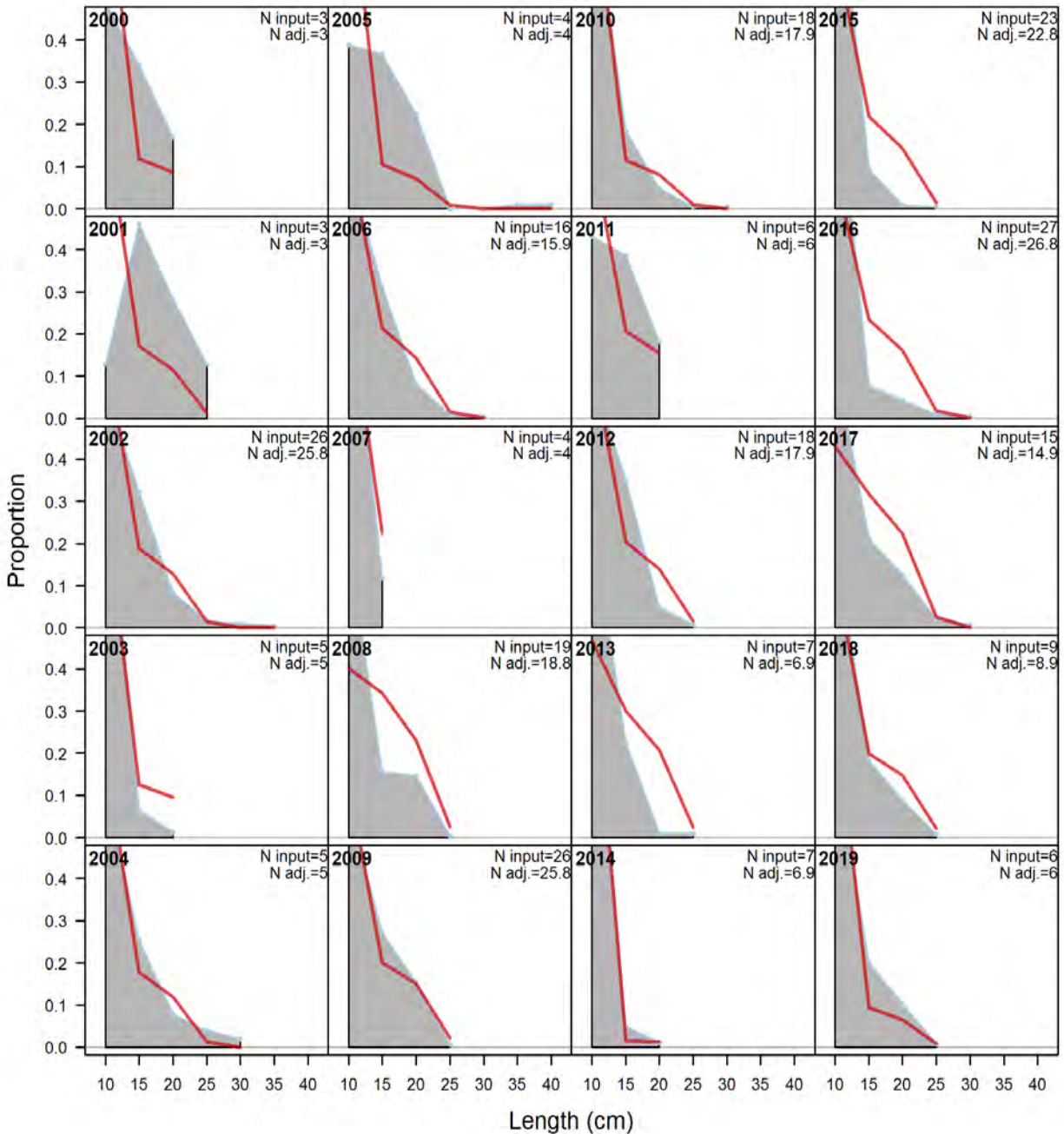


Figure 42. Length compositions, discard, Shrimp Bycatch East. ‘N input’ is the input sample size. ‘N adj.’ is the sample size after adjustment by the Dirichlet-Multinomial  $\Theta$  parameter based on the formula  $N\ adj. = 1 / (1+\Theta) + N \Theta / (1+\Theta)$ . For this fleet,  $\Theta = 138.238$  and the sample size multiplier is approximately  $\Theta / (1+\Theta) = 0.993$ .\*



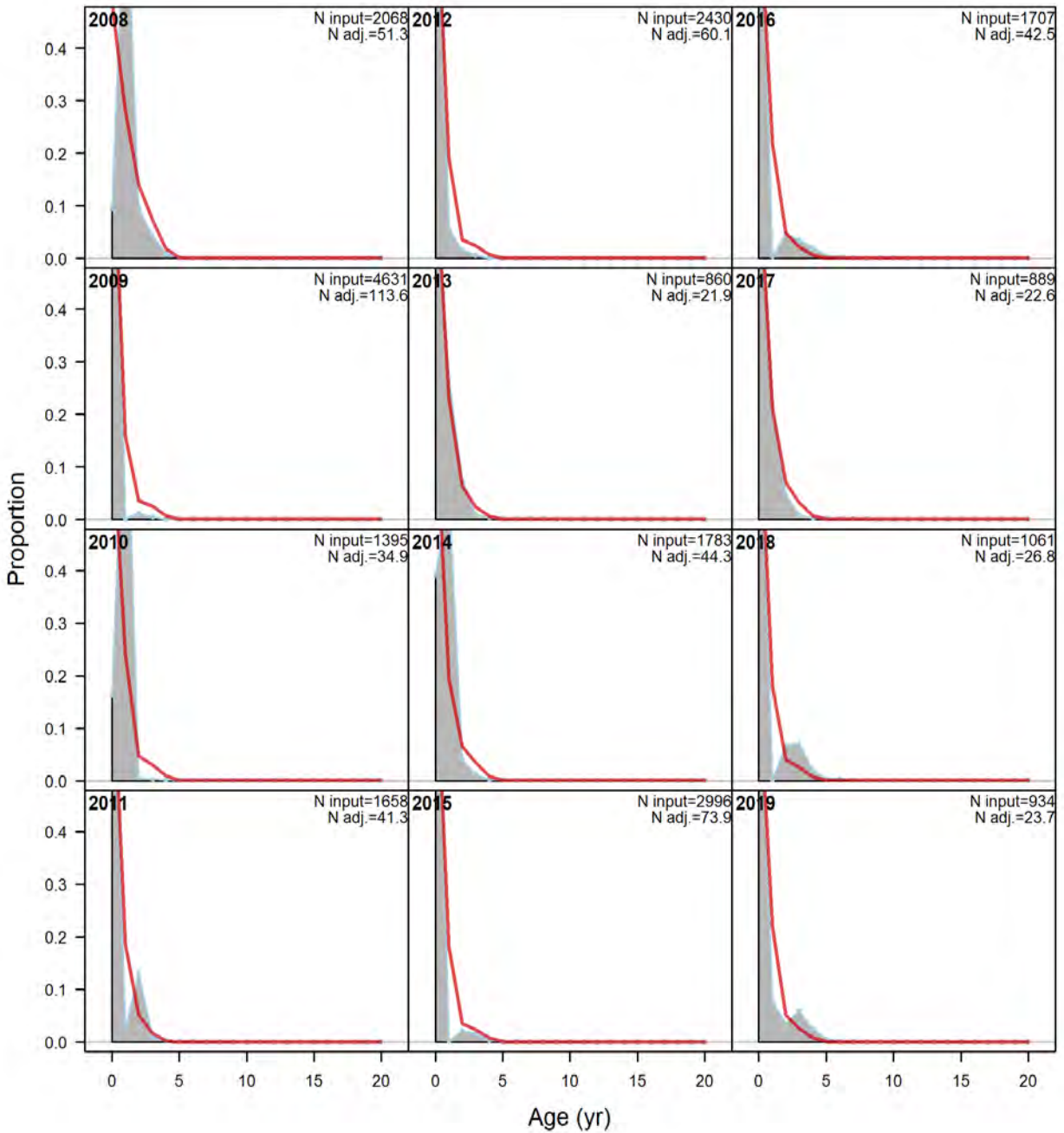


Figure 43. Age compositions, whole catch, SEAMAP Fall Trawl Post-2007 West. 'N input' is the input sample size. 'N adj.' is the sample size after adjustment by the Dirichlet-Multinomial  $\Theta$  parameter based on the formula  $N \text{ adj.} = 1 / (1 + \Theta) + N \Theta / (1 + \Theta)$ . For this fleet,  $\Theta = 0.024$  and the sample size multiplier is approximately  $\Theta / (1 + \Theta) = 0.023$ .\*

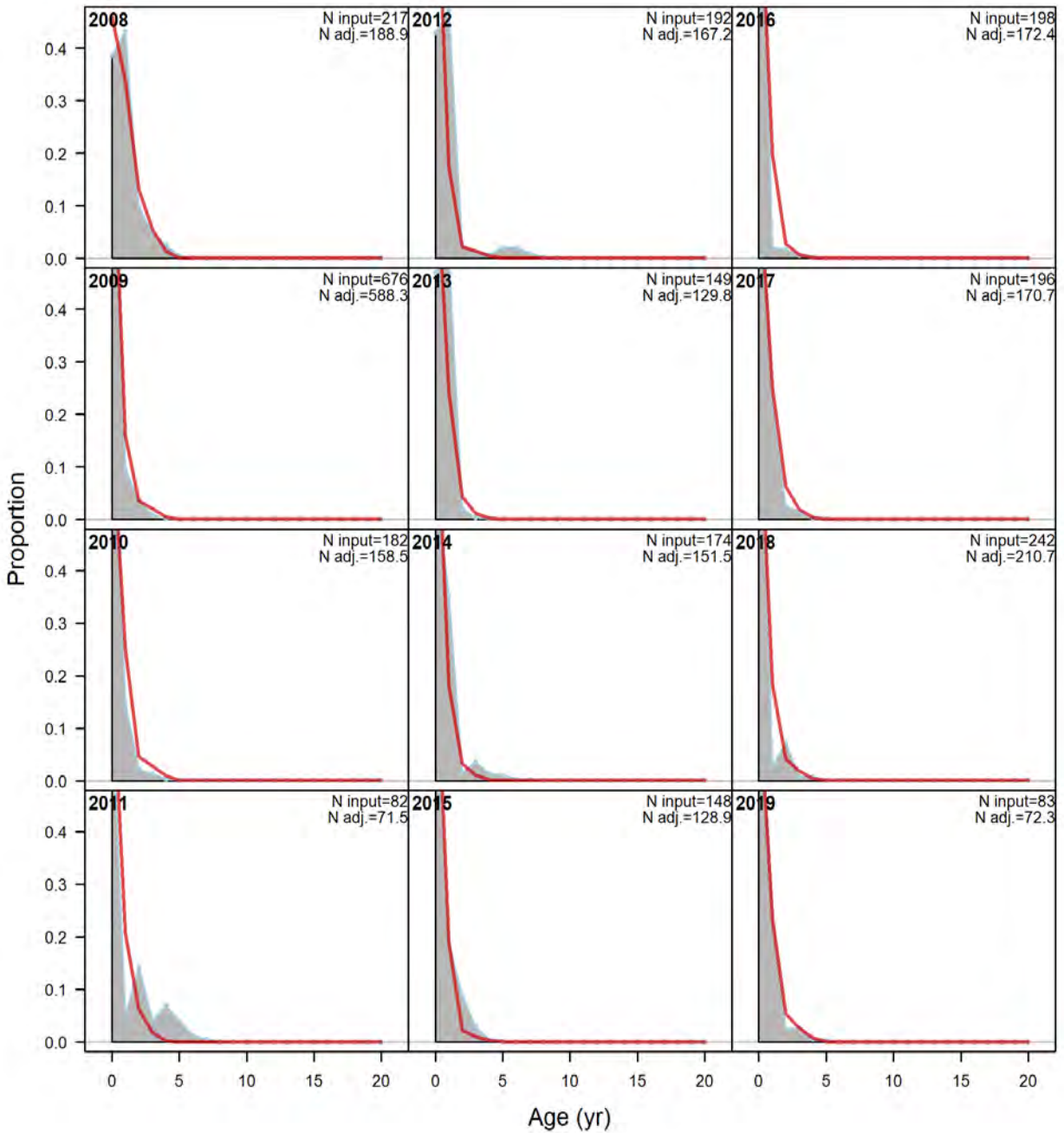


Figure 44. Age compositions, whole catch, SEAMAP Fall Trawl Post-2007 Central. 'N input' is the input sample size. 'N adj.' is the sample size after adjustment by the Dirichlet-Multinomial  $\Theta$  parameter based on the formula  $N \text{ adj.} = 1 / (1 + \Theta) + N \Theta / (1 + \Theta)$ . For this fleet,  $\Theta = 6.828$  and the sample size multiplier is approximately  $\Theta / (1 + \Theta) = 0.872$ .\*

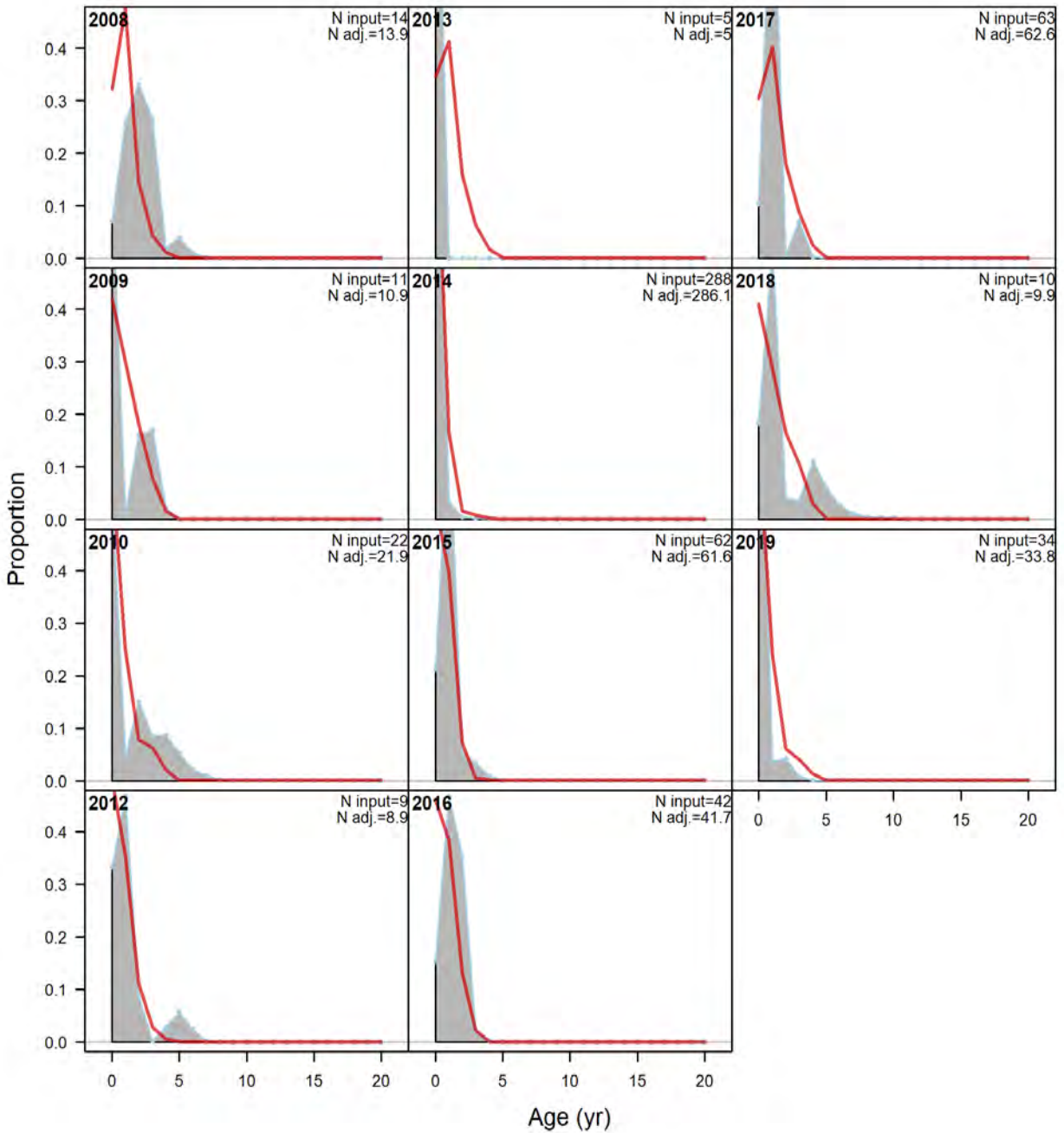


Figure 45. Age compositions, whole catch, SEAMAP Fall Trawl Post-2007 East. ‘N input’ is the input sample size. ‘N adj.’ is the sample size after adjustment by the Dirichlet-Multinomial  $\Theta$  parameter based on the formula  $N \text{ adj.} = 1 / (1 + \Theta) + N \Theta / (1 + \Theta)$ . For this fleet,  $\Theta = 120.621$  and the sample size multiplier is approximately  $\Theta / (1 + \Theta) = 0.992$ .\*

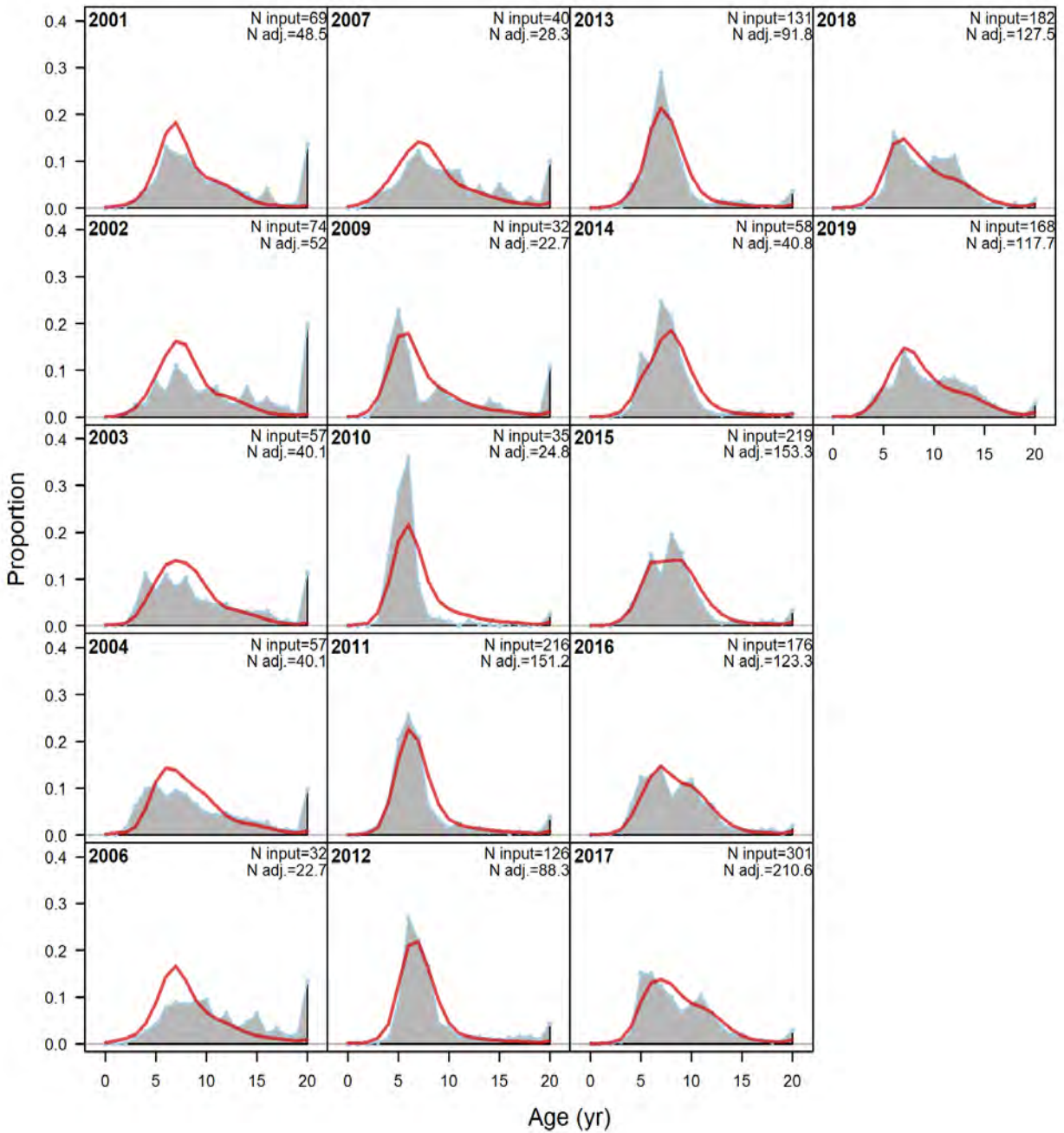


Figure 46. Age compositions, whole catch, Bottom Longline West. 'N input' is the input sample size. 'N adj.' is the sample size after adjustment by the Dirichlet-Multinomial  $\Theta$  parameter based on the formula  $N\ adj. = 1 / (1+\Theta) + N \Theta / (1+\Theta)$ . For this fleet,  $\Theta = 10.858$  and the sample size multiplier is approximately  $\Theta / (1+\Theta) = 0.916$ .\*



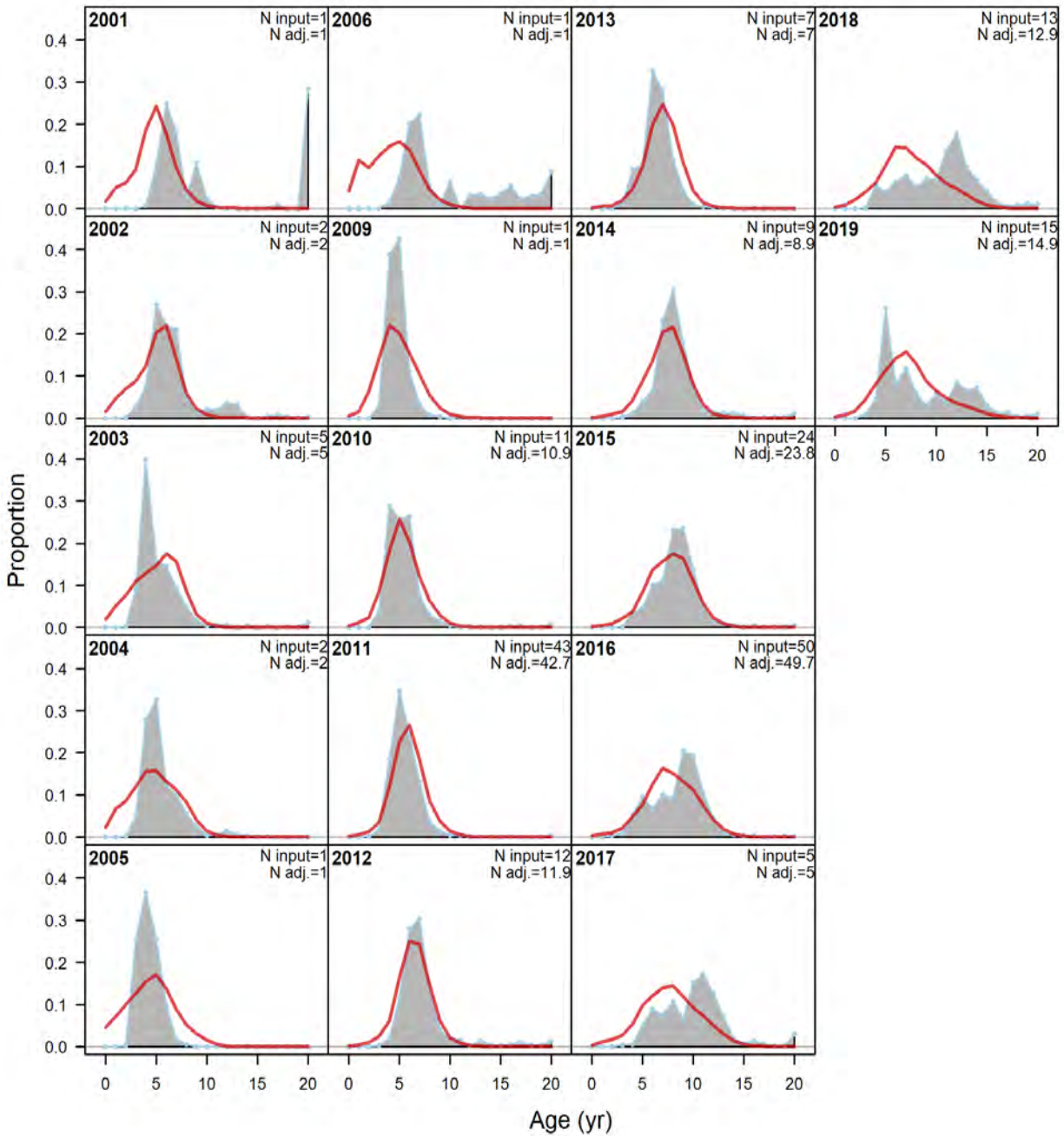


Figure 47. Age compositions, whole catch, Bottom Longline Central. 'N input' is the input sample size. 'N adj.' is the sample size after adjustment by the Dirichlet-Multinomial  $\Theta$  parameter based on the formula  $N \text{ adj.} = 1 / (1 + \Theta) + N \Theta / (1 + \Theta)$ . For this fleet,  $\Theta = 148$  and the sample size multiplier is approximately  $\Theta / (1 + \Theta) = 0.993$ .\*

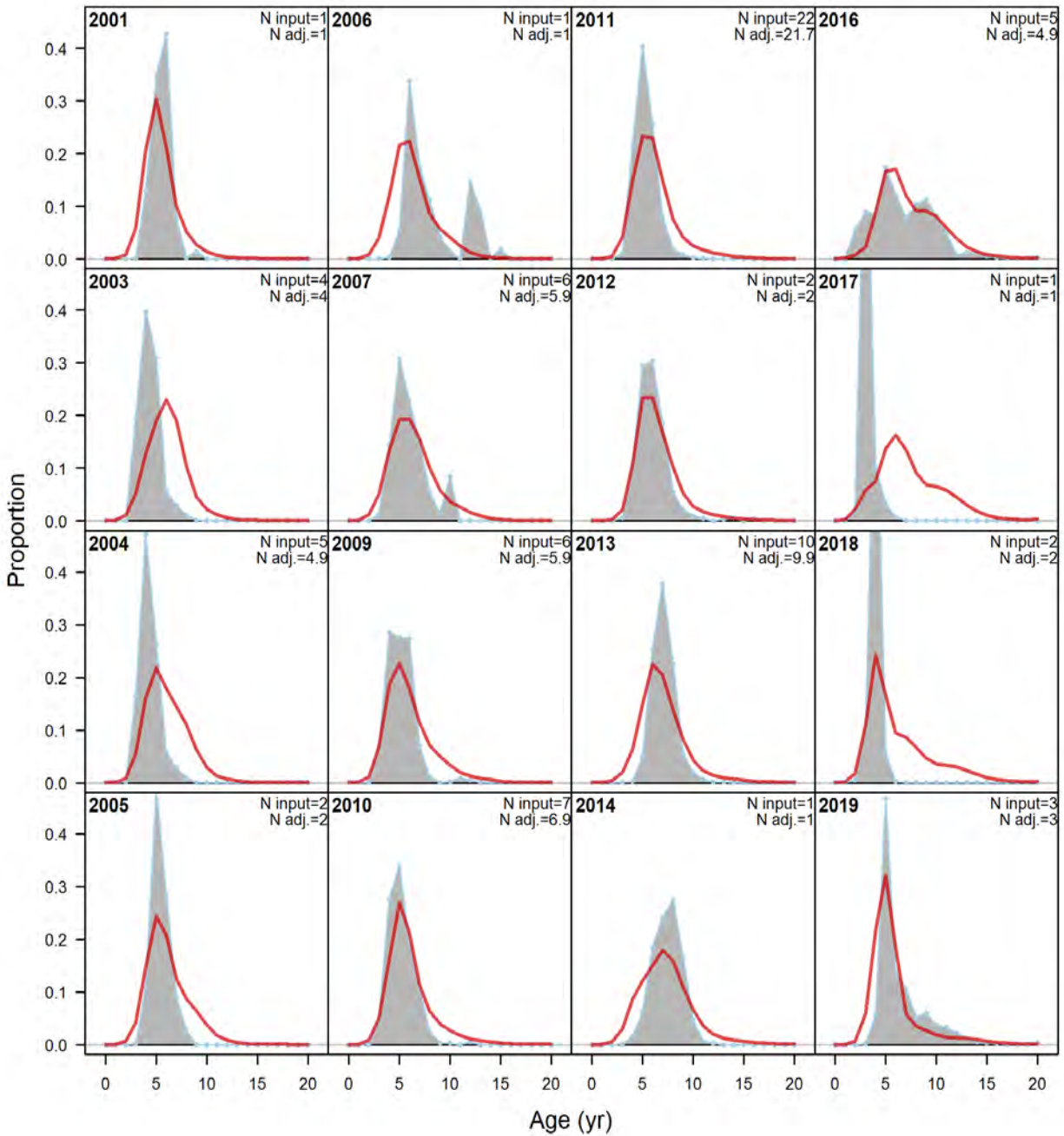
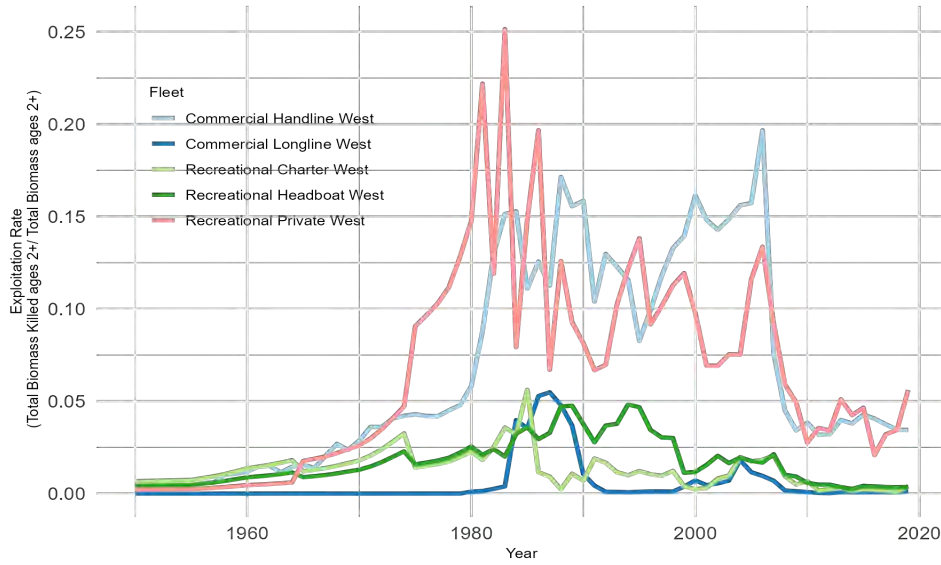


Figure 48. Age compositions, whole catch, Bottom Longline East. ‘N input’ is the input sample size. ‘N adj.’ is the sample size after adjustment by the Dirichlet-Multinomial  $\Theta$  parameter based on the formula  $N\ adj. = 1 / (1+\Theta) + N \Theta / (1+\Theta)$ . For this fleet,  $\Theta = 3.838$  and the sample size multiplier is approximately  $\Theta / (1+\Theta) = 0.793$ .\*

**West**



**Central**

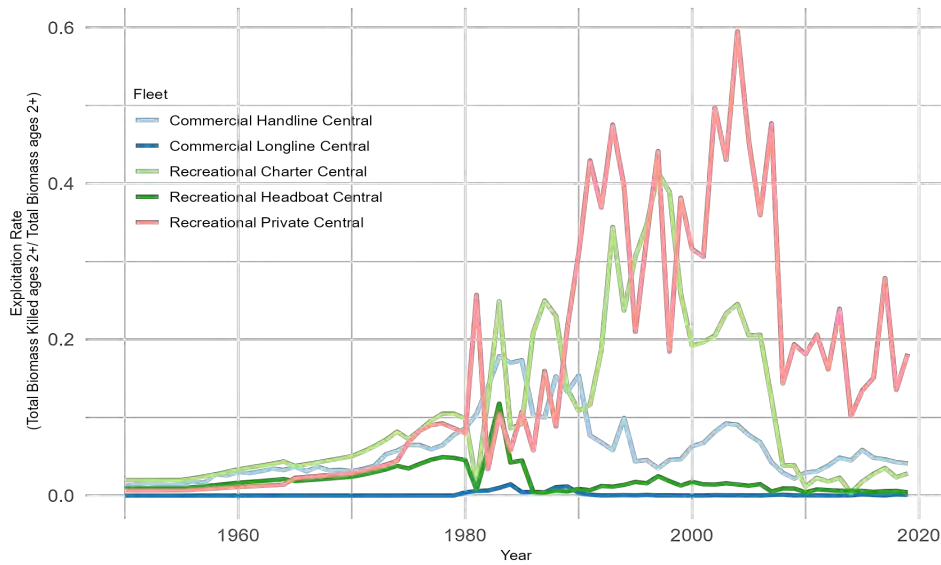


Figure 49. Annual exploitation rate (total biomass killed 2+ / total biomass age 2+) by fleet for Gulf of Mexico Red Snapper.

East

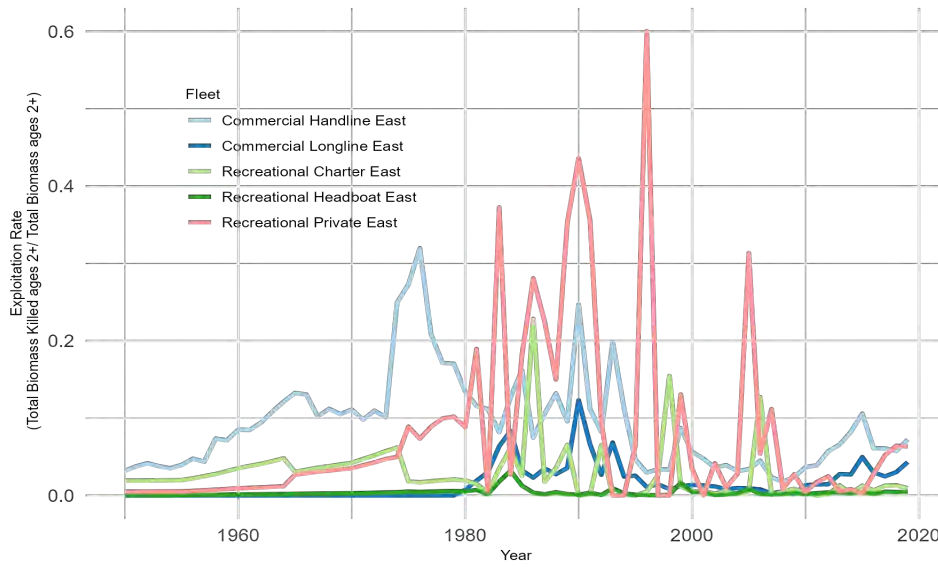
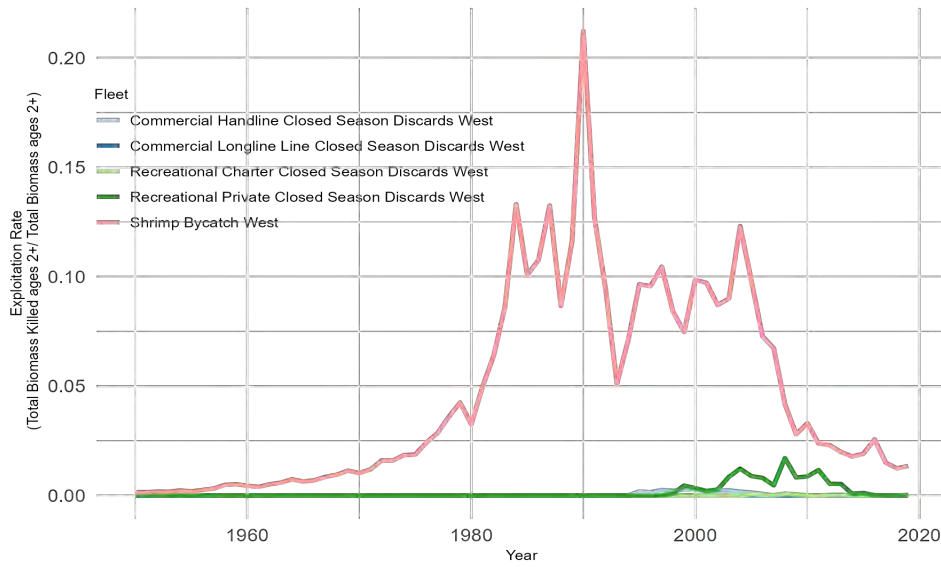


Figure 49 Continued. Annual exploitation rate (total biomass killed 2+ / total biomass age 2+) by fleet for Gulf of Mexico Red Snapper.

**West**



**Central**

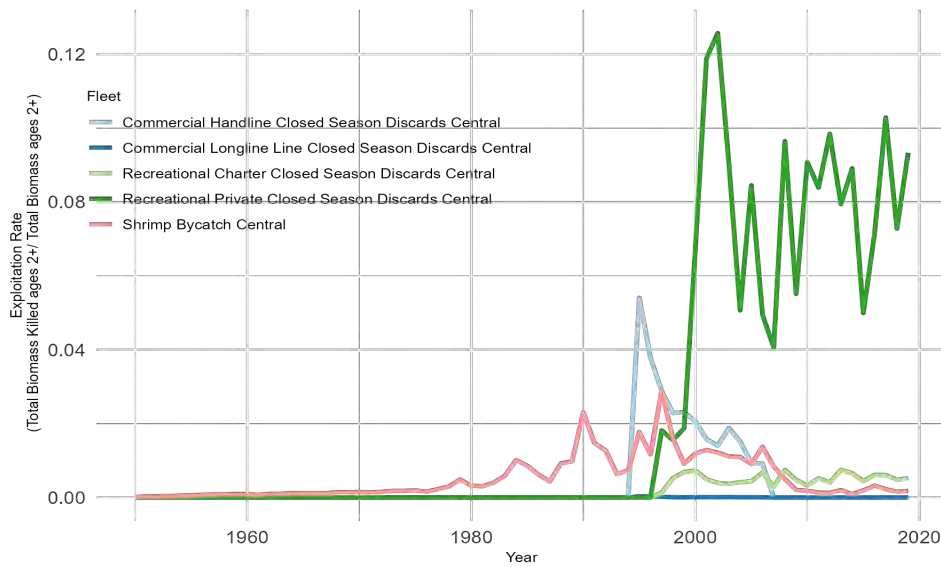


Figure 50. Annual exploitation rate for Gulf of Mexico Red Snapper discard and bycatch (total biomass killed 2+ / total biomass age 2+) fleets.

**East**

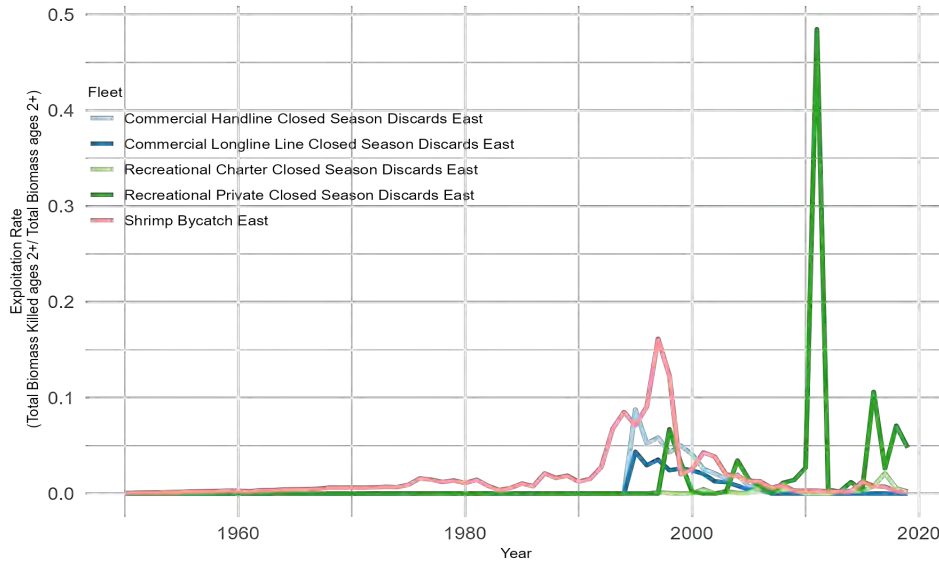


Figure 50 Continued. Annual exploitation rate for Gulf of Mexico Red Snapper discard and bycatch (total biomass killed 2+ / total biomass age 2+) fleets.



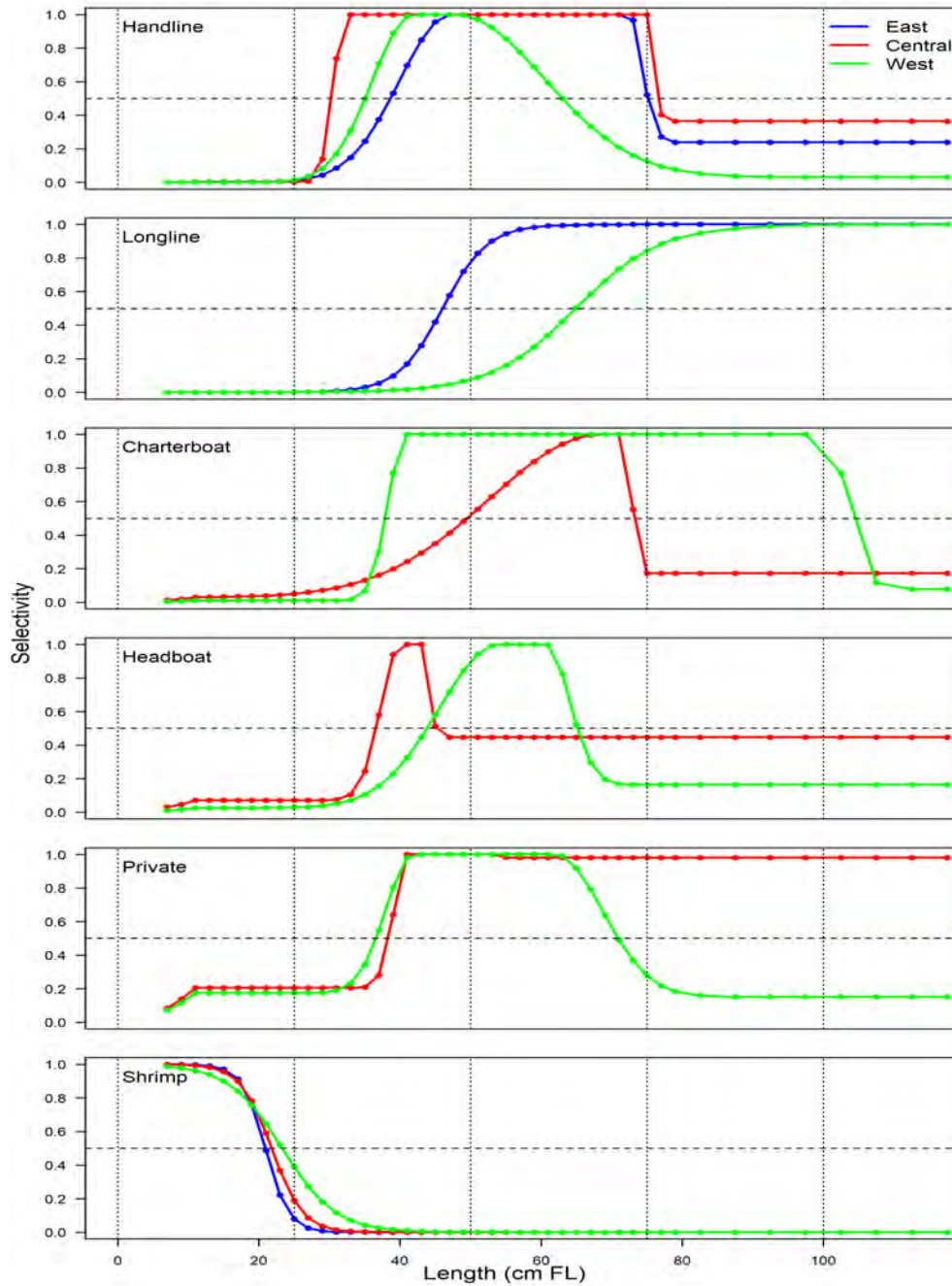


Figure 51. Length-based selectivity for commercial and recreational fleets for Gulf of Mexico Red Snapper in the terminal year of the assessment. Dashed horizontal line indicates 50%, whereas the dashed vertical lines identify lengths in 25 cm FL intervals. Note: The east area selectivity curve mirrors the central area curve in the recreational fleets.

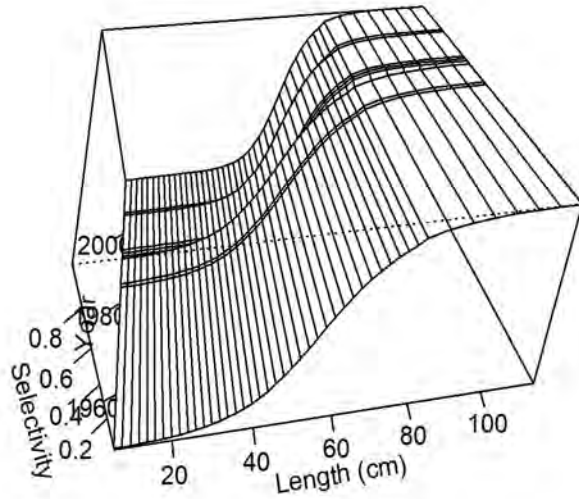


Figure 52. Time varying length-based selectivity for the Commercial Longline West fleet.

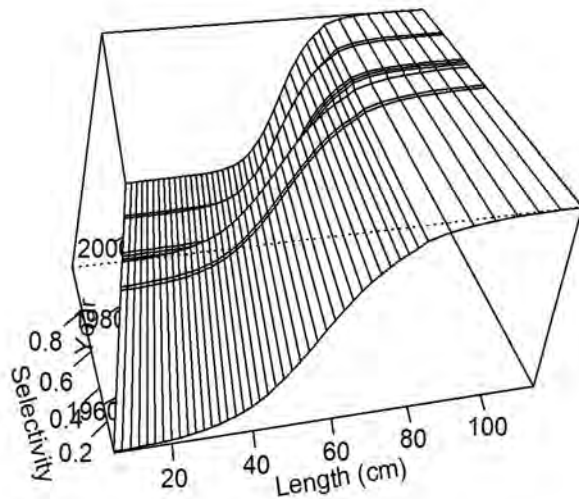


Figure 53. Time varying length-based selectivity for the Commercial Longline Central fleet.



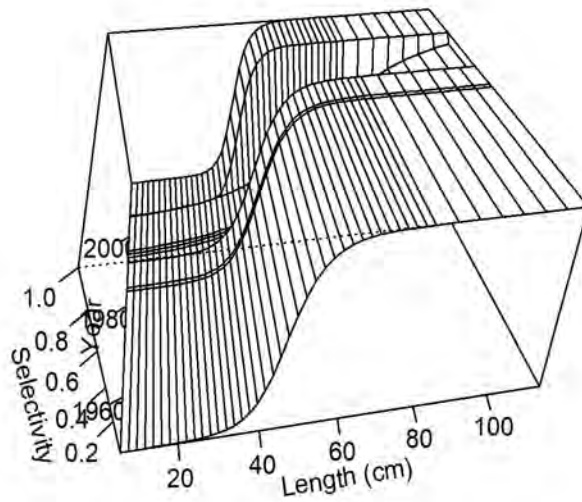


Figure 54. Time varying length-based selectivity for the Commercial Longline East fleet.

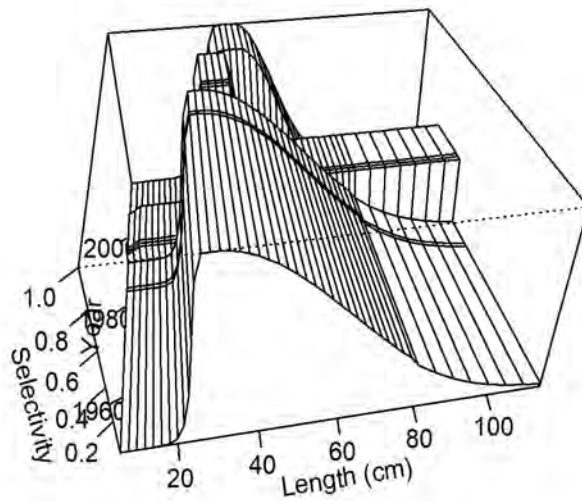


Figure 55. Time varying length-based selectivity for the Commercial Handline West fleet.

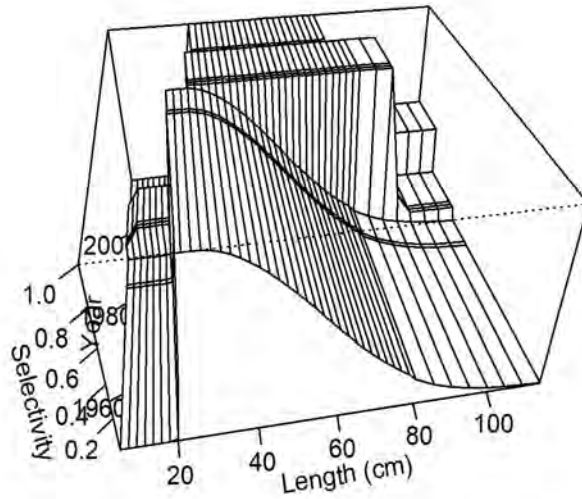


Figure 56. Time varying length-based selectivity for the Commercial Handline Central fleet.

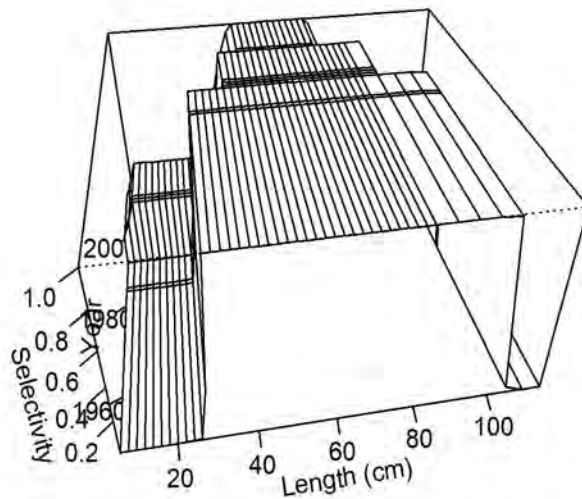


Figure 57. Time varying length-based selectivity for the Commercial Handline East fleet.

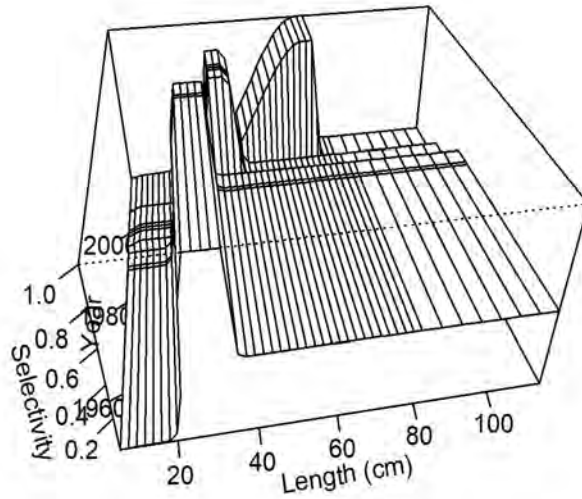


Figure 58. Time varying length-based selectivity for the Recreational Charter West fleet.

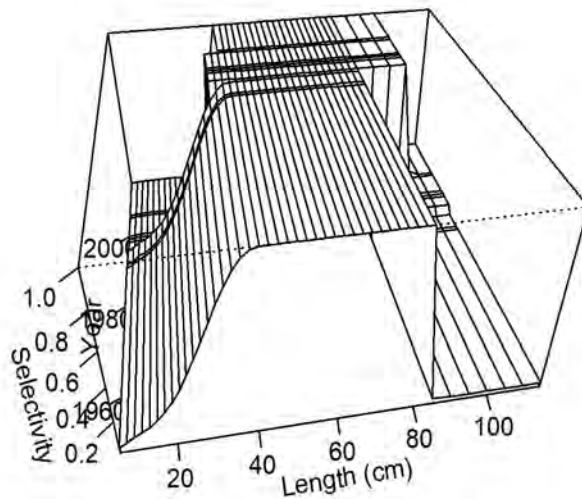


Figure 59. Time varying length-based selectivity for the Recreational Charter Central fleet.

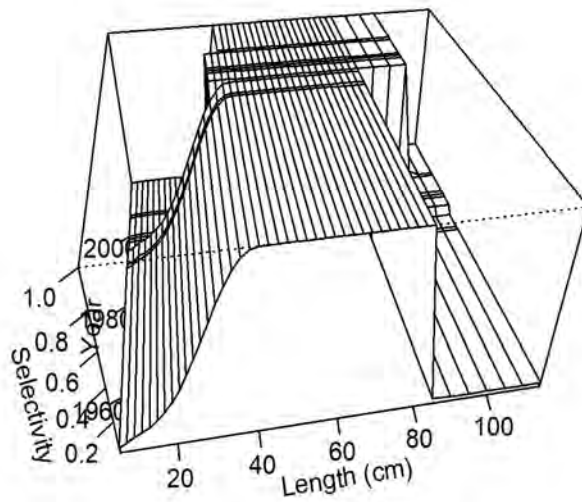


Figure 60. Time varying length-based selectivity for the Recreational Charter East fleet.

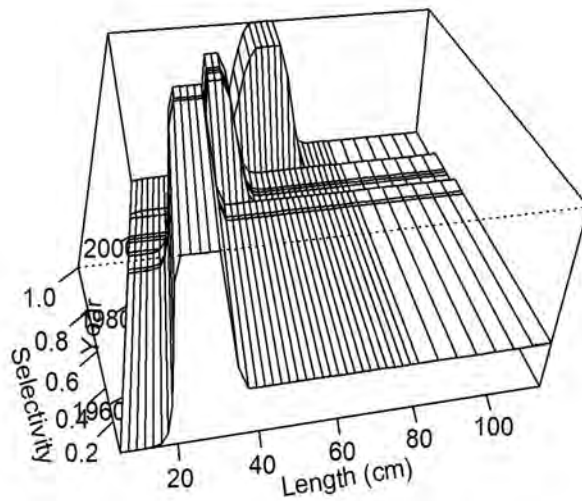


Figure 61. Time varying length-based selectivity for the Recreational Headboat West fleet.

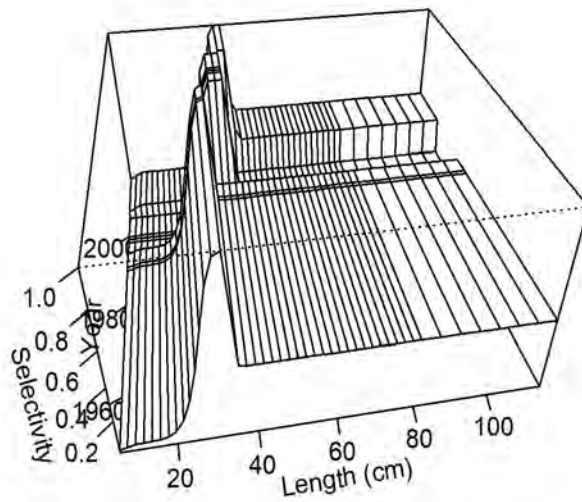


Figure 62. Time varying length-based selectivity for the Recreational Headboat Central fleet.

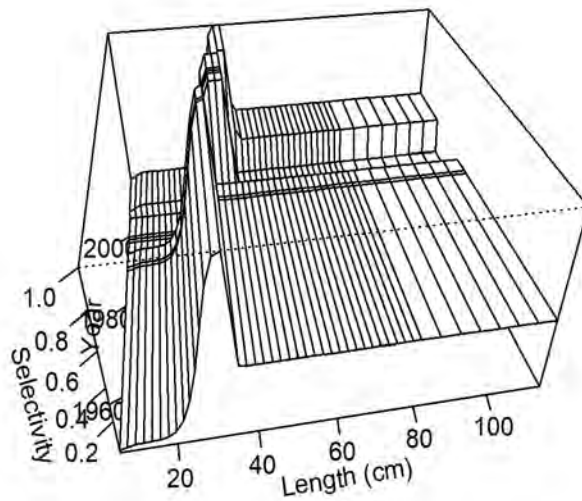


Figure 63. Time varying length-based selectivity for the Recreational Headboat East fleet.

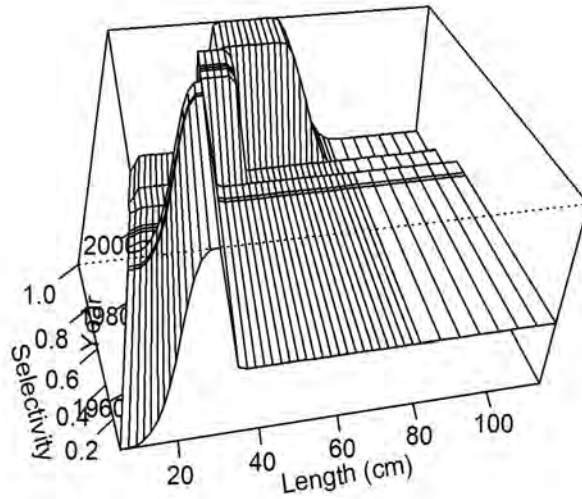


Figure 64. Time varying length-based selectivity for the Recreational Private West fleet.

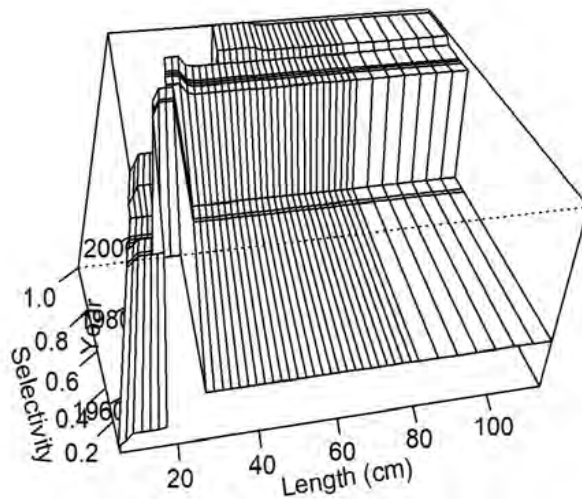


Figure 65. Time varying length-based selectivity for the Recreational Private Central fleet.

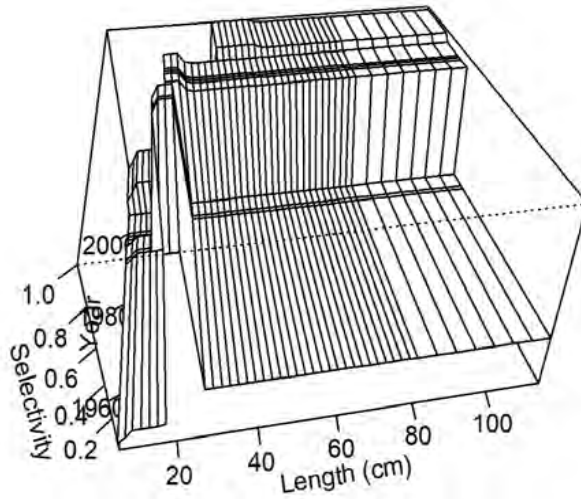


Figure 66. Time varying length-based selectivity for the Recreational Private East fleet.

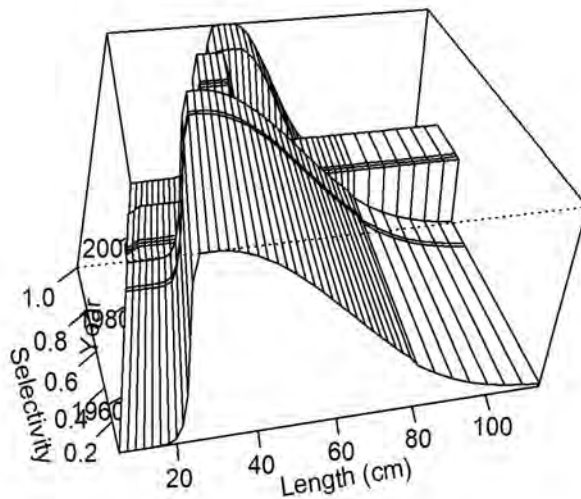


Figure 67. Time varying length-based selectivity for the Commercial Handline Closed Season Discards West fleet.

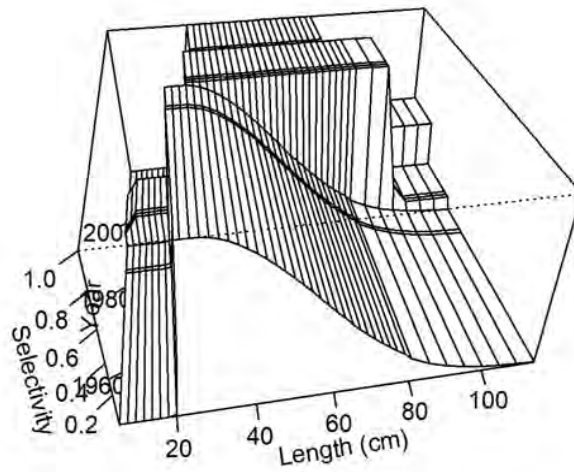


Figure 68. Time varying length-based selectivity for the Commercial Handline Closed Season Discards Central fleet.

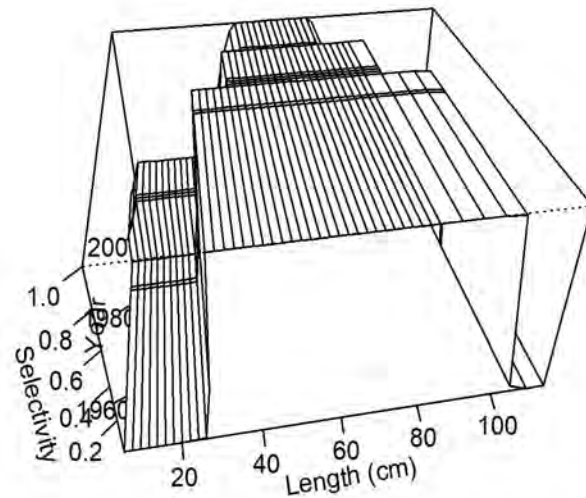


Figure 69. Time varying length-based selectivity for the Commercial Handline Closed Season Discards East fleet.



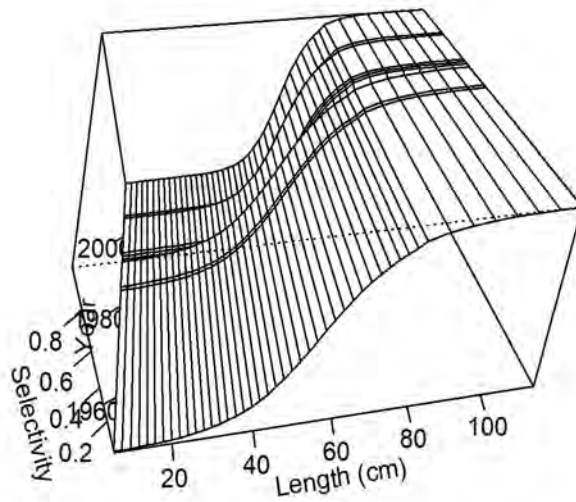


Figure 70. Time varying length-based selectivity for the Commercial Longline Closed Season Discards West fleet.

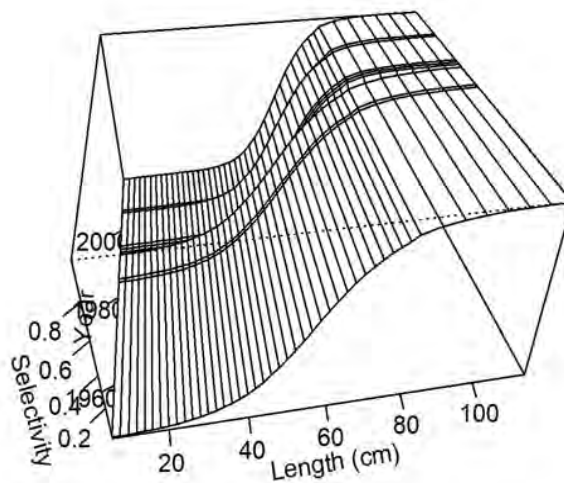


Figure 71. Time varying length-based selectivity for the Commercial Longline Closed Season Discards Central fleet.

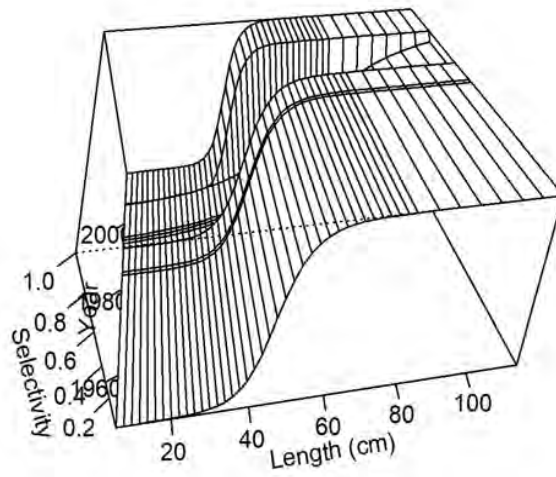


Figure 72. Time varying length-based selectivity for the Commercial Longline Closed Season Discards East fleet.

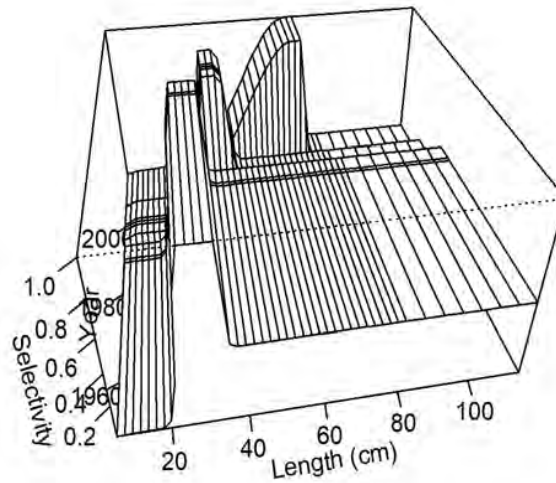


Figure 73. Time varying length-based selectivity for the Recreational Charter Closed Season Discards West fleet.

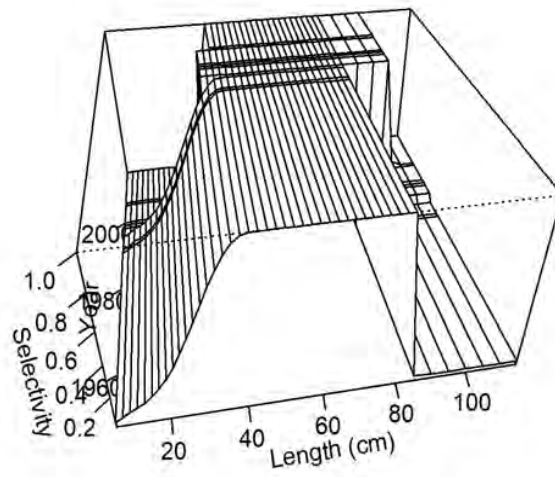


Figure 74. Time varying length-based selectivity for the Recreational Charter Closed Season Discards Central fleet.

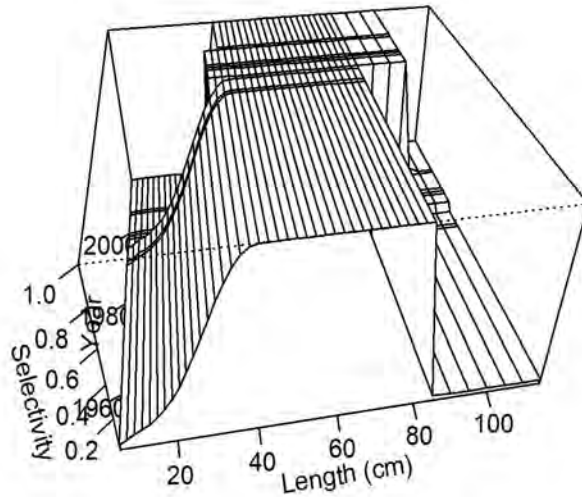


Figure 75. Time varying length-based selectivity for the Recreational Charter Closed Season Discards East fleet.

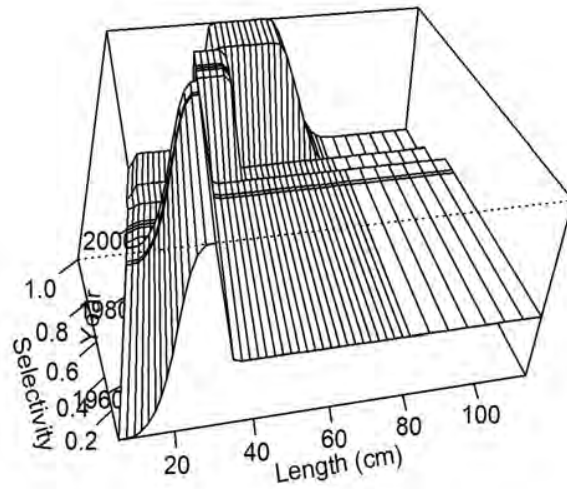


Figure 76. Time varying length-based selectivity for the Recreational Private Closed Season Discards West fleet.

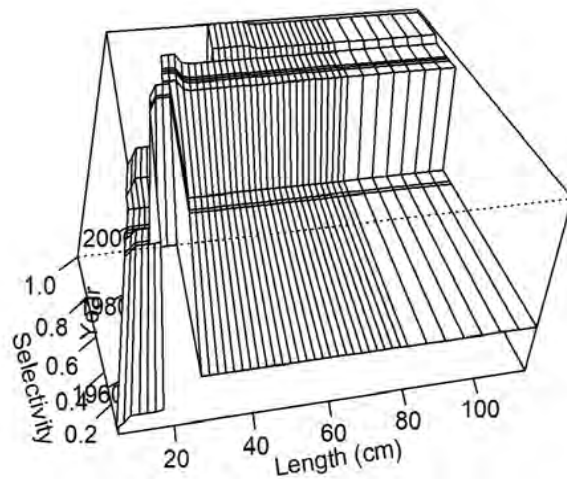


Figure 77. Time varying length-based selectivity for the Recreational Private Closed Season Discards Central fleet.

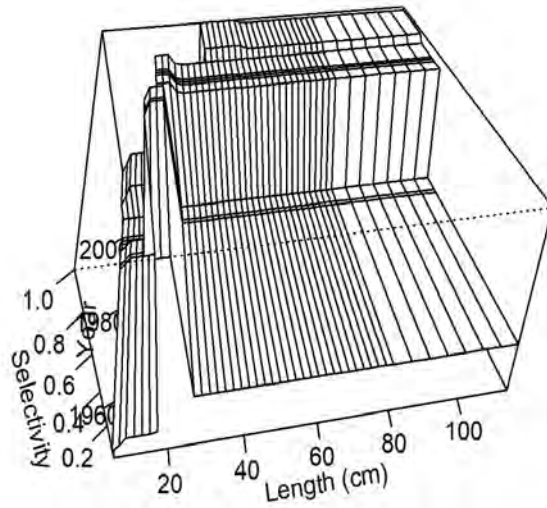


Figure 78. Time varying length-based selectivity for the Recreational Private Closed Season Discards East fleet.

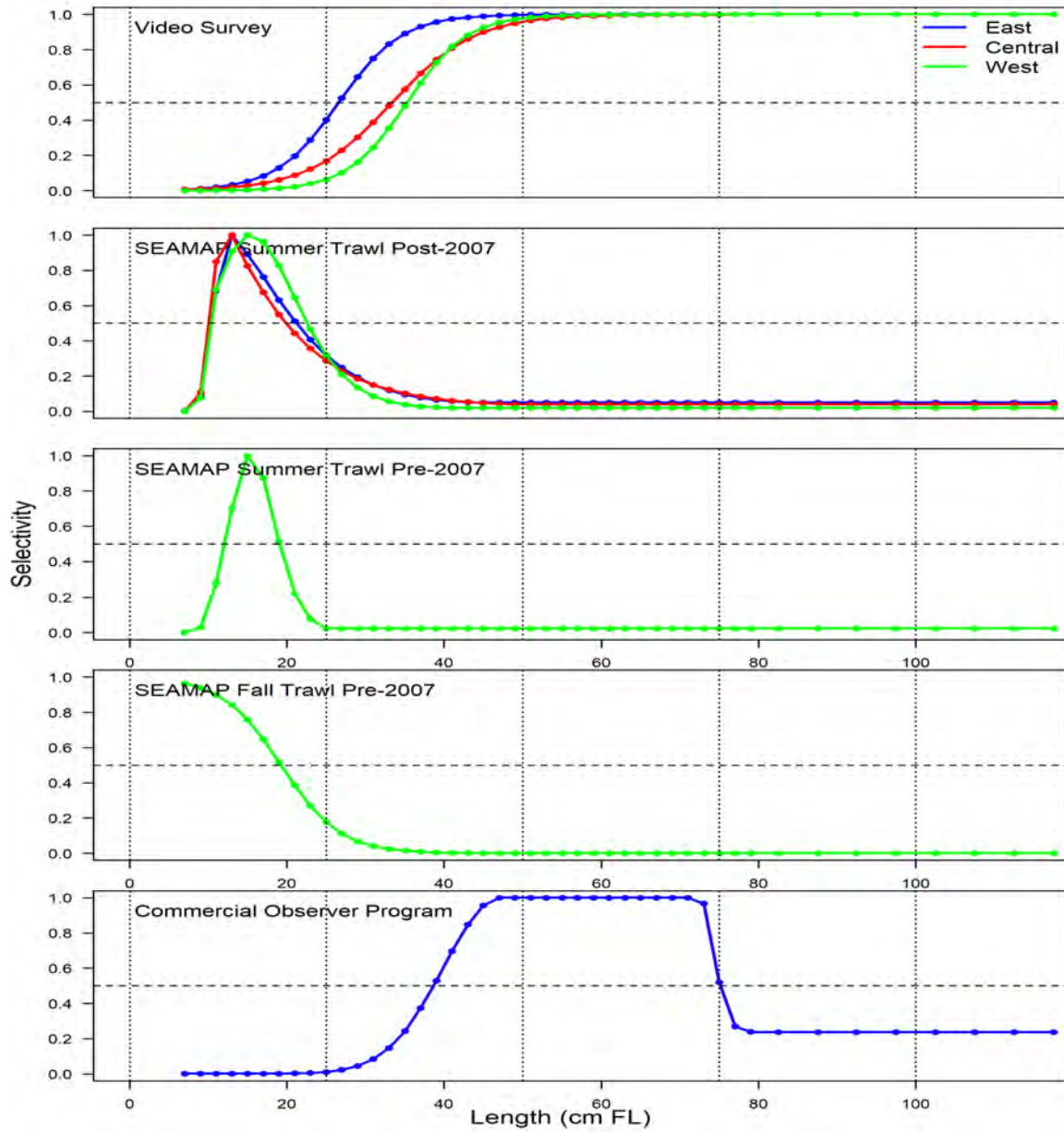


Figure 79. Length-based selectivity for surveys for Gulf of Mexico Red Snapper in the terminal year of the assessment. Dashed horizontal line indicates 50%, whereas the dashed vertical lines identify lengths in 25 cm FL intervals.

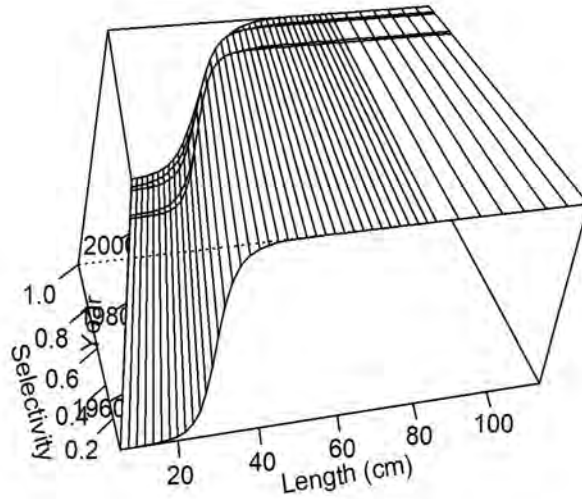
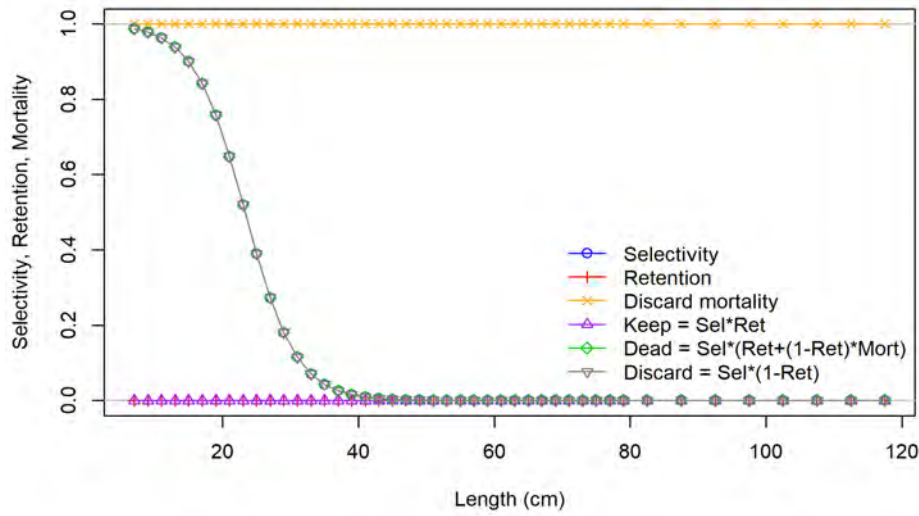


Figure 80. Time varying length-based selectivity for the Combined Video Survey Central fleet.

West



Central

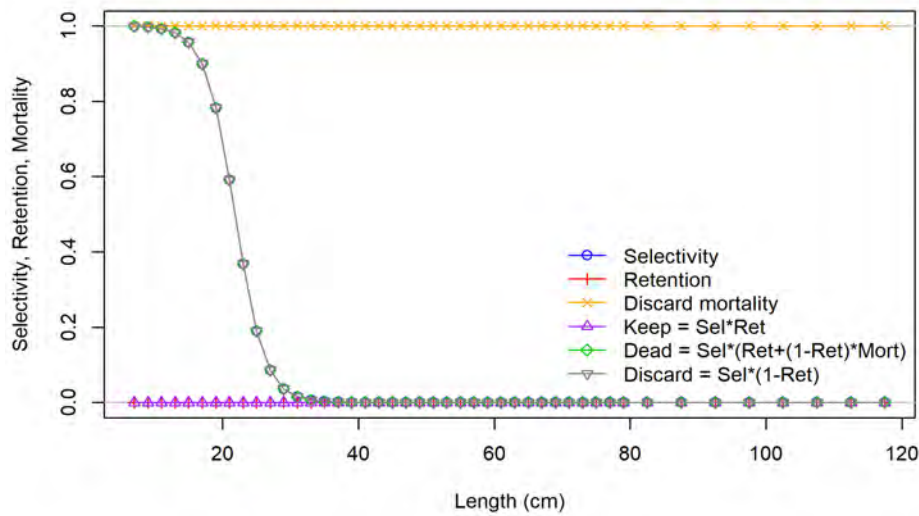


Figure 81. Length-based selectivity and retention for the Shrimp Bycatch fleet in the terminal year of the assessment. Selectivity (blue line) and retention (red line) vary, while discard mortality (orange line) is constant.



East

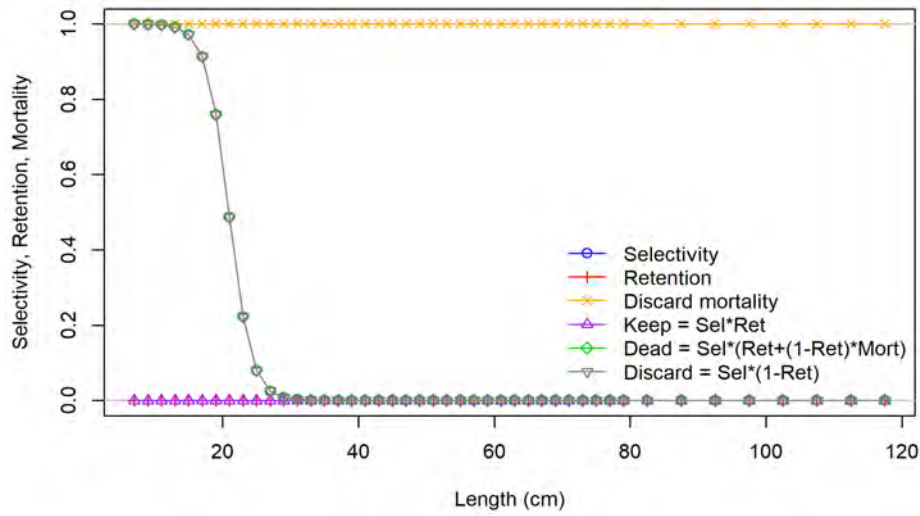


Figure 81 Continued. Length-based selectivity and retention for the Shrimp Bycatch fleet in the terminal year of the assessment. Selectivity (blue line) and retention (red line) vary, while discard mortality (orange line) is constant.

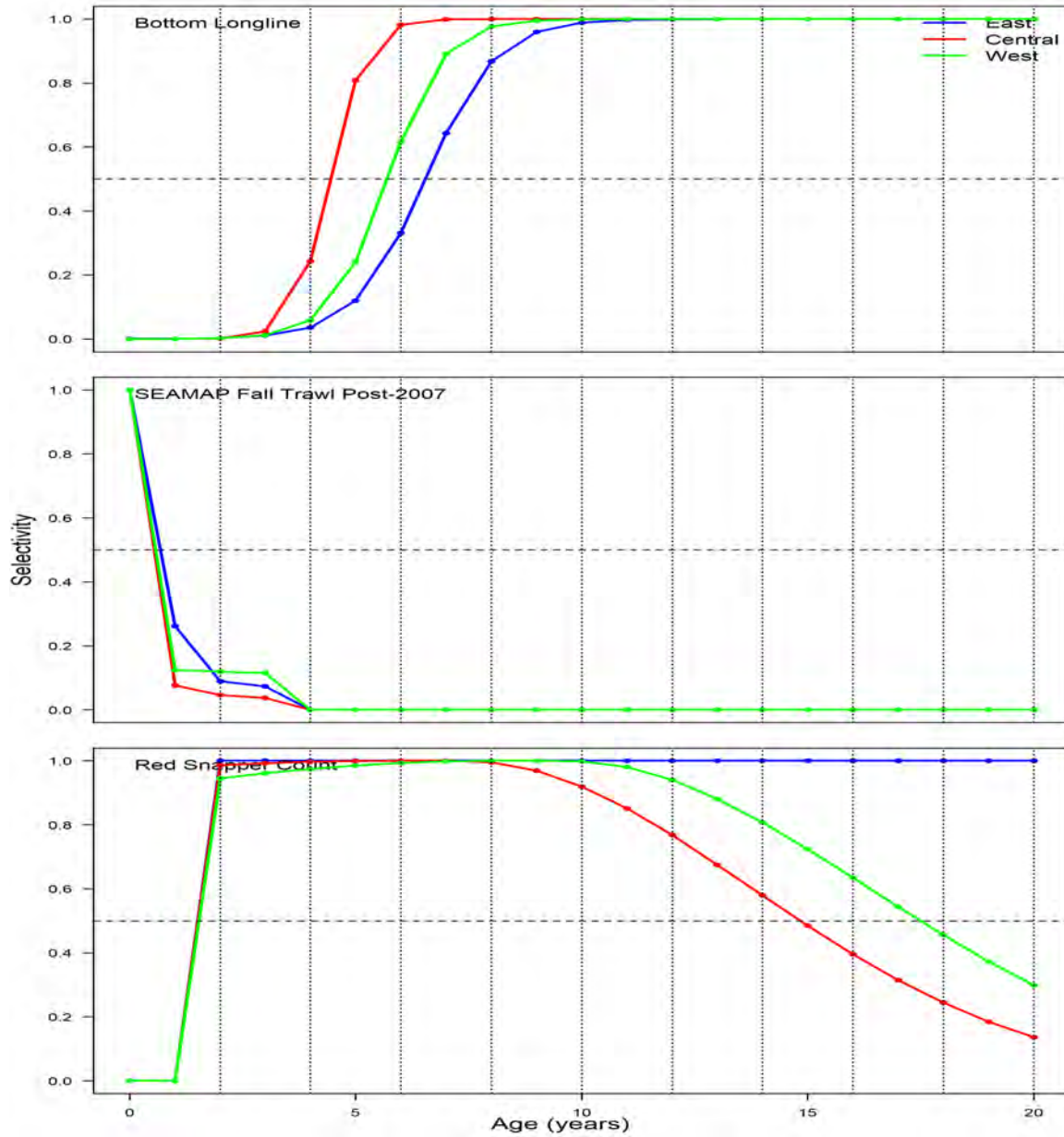


Figure 82. Derived age-based selectivity for specific surveys for Gulf of Mexico Red Snapper in the terminal year of the assessment. Dashed horizontal line indicates 50%, whereas the dashed vertical lines identify ages in 2 year intervals.

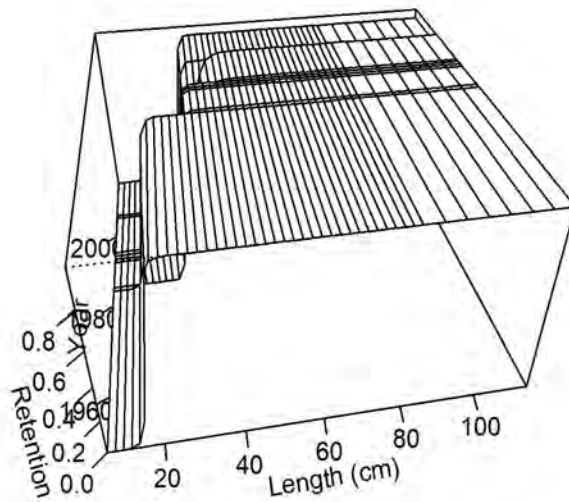


Figure 83. Time varying length-based retention for the Commercial Handline West fleet.

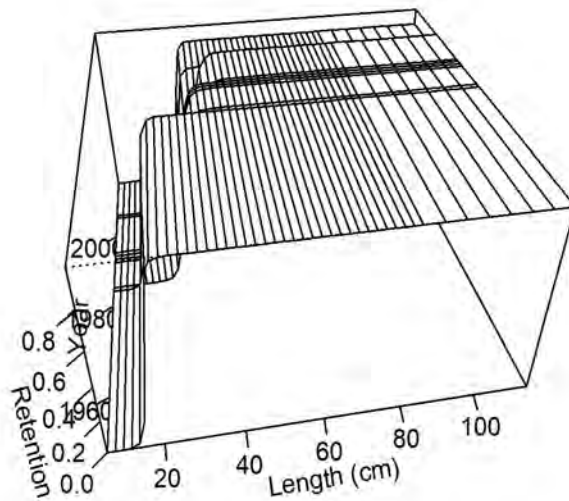


Figure 84. Time varying length-based retention for the Commercial Handline Central fleet.

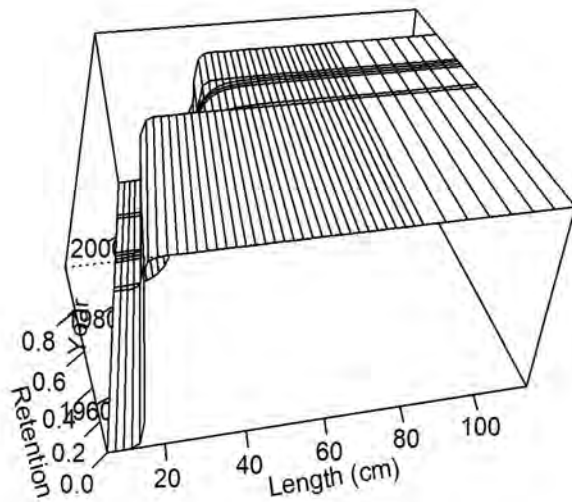


Figure 85. Time varying length-based retention for the Commercial Handline East fleet.

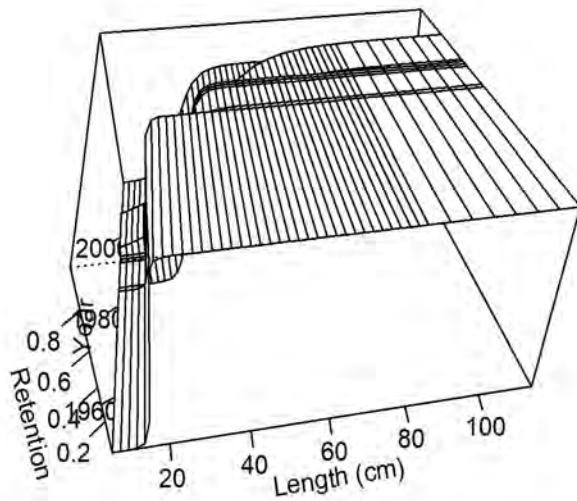


Figure 86. Time varying length-based retention for the Commercial Longline West fleet.

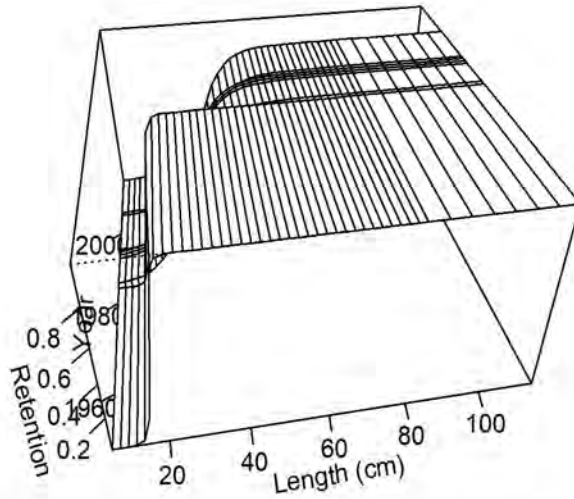


Figure 87. Time varying length-based retention for the Commercial Longline Central fleet.

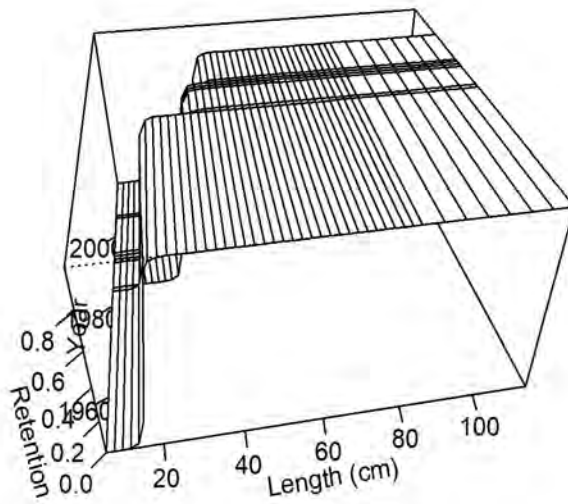


Figure 88. Time varying length-based retention for the Commercial Longline East fleet.

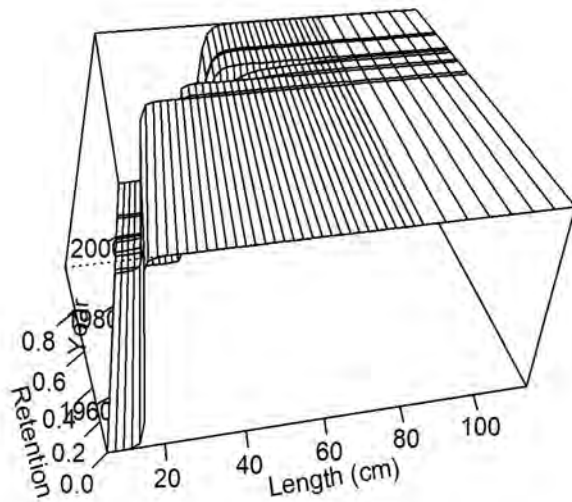


Figure 89. Time varying length-based retention for the Recreational Charter West fleet.

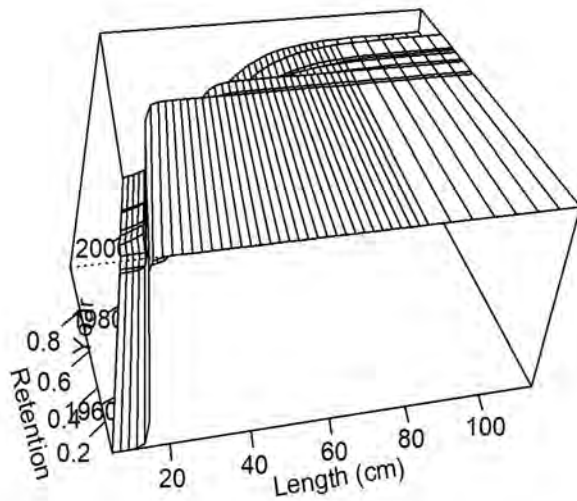


Figure 90. Time varying length-based retention for the Recreational Charter Central fleet.

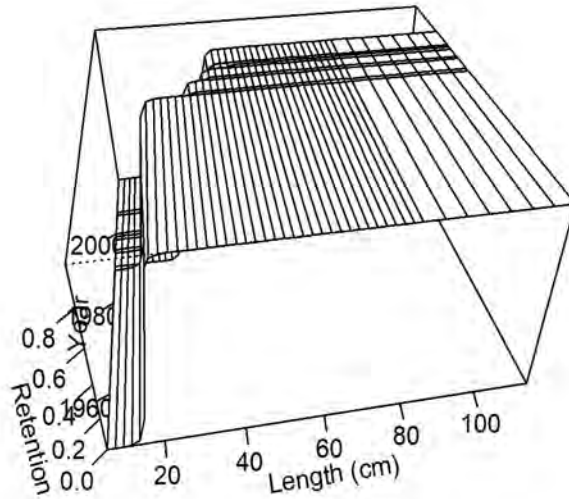


Figure 91. Time varying length-based retention for the Recreational Charter East fleet.

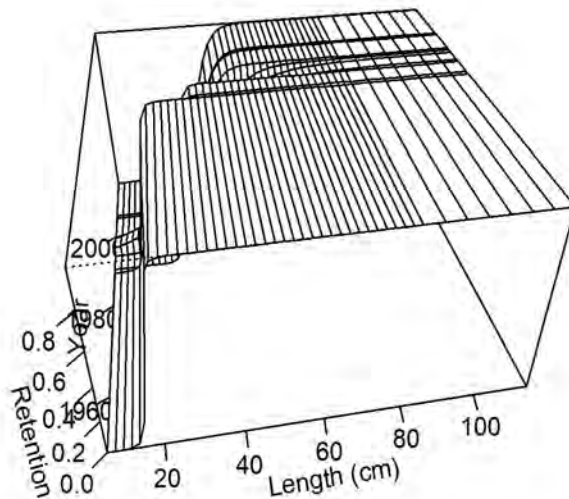


Figure 92. Time varying length-based retention for the Recreational Headboat West fleet.

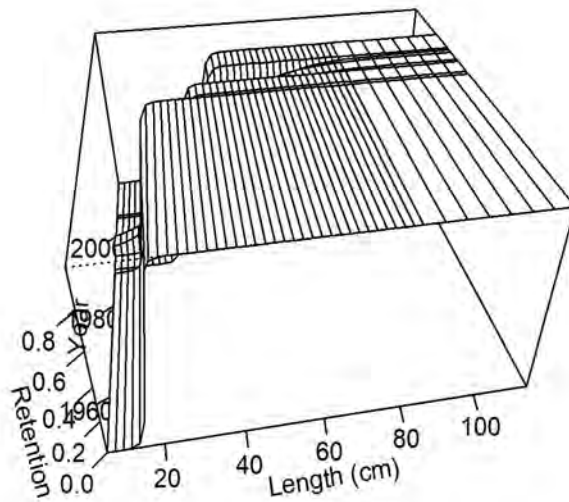


Figure 93. Time varying length-based retention for the Recreational Headboat Central fleet.

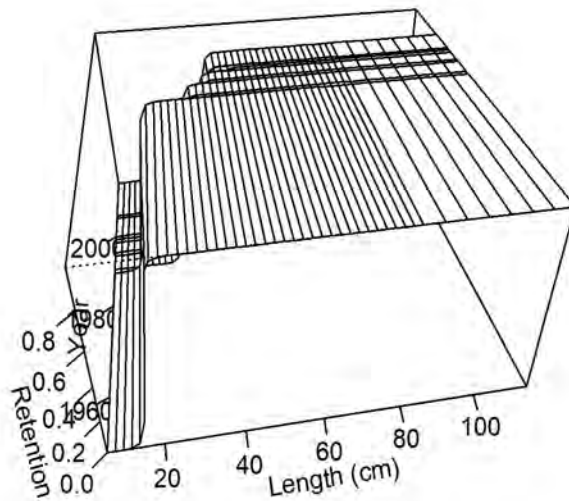


Figure 94. Time varying length-based retention for the Recreational Headboat East fleet.



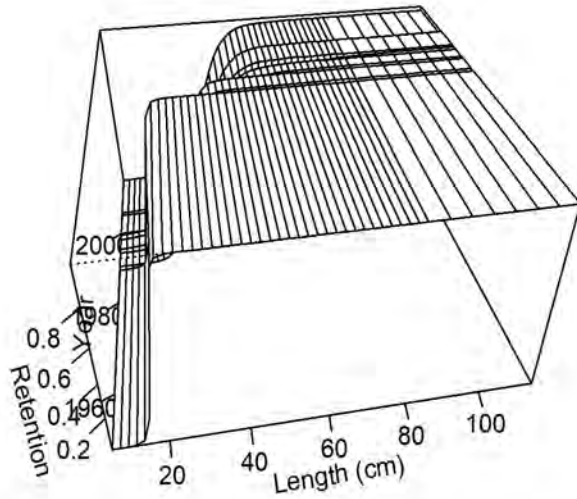


Figure 95. Time varying length-based retention for the Recreational Private West fleet.

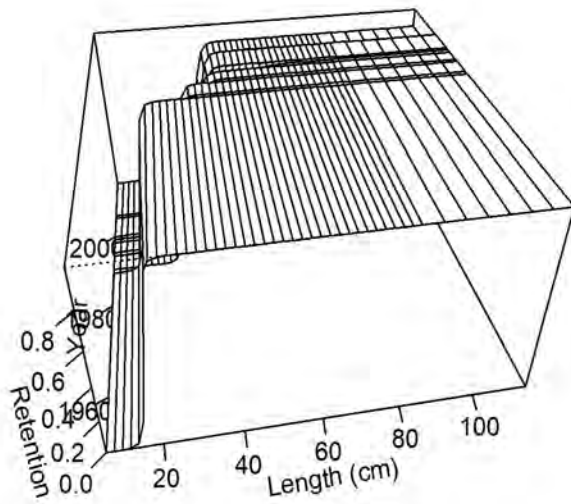


Figure 96. Time varying length-based retention for the Recreational Private Central fleet.

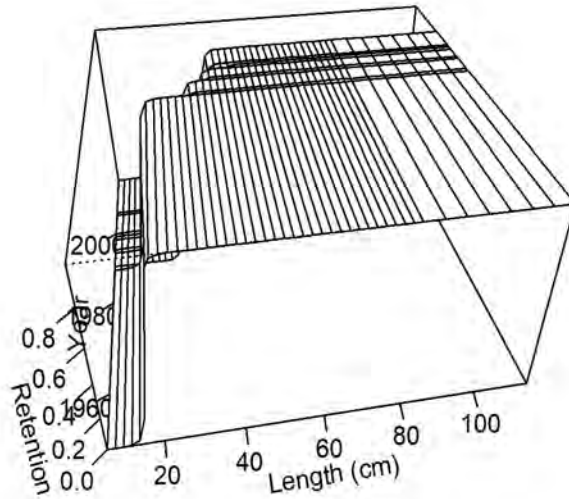


Figure 97. Time varying length-based retention for the Recreational Private East fleet.

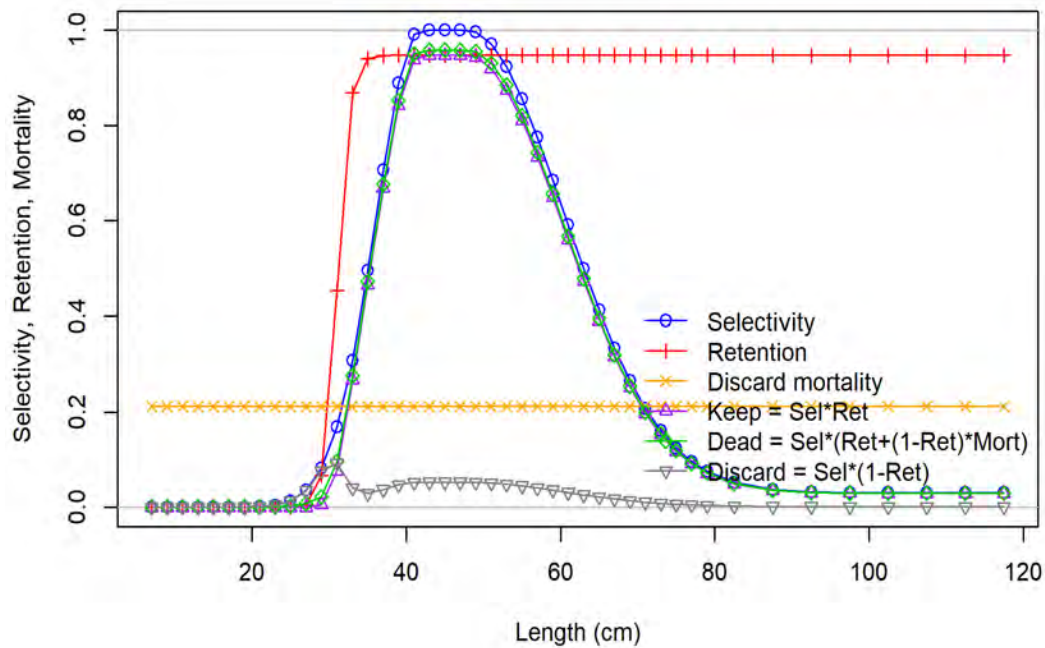


Figure 98. Length-based selectivity and retention for the Commercial Handline West fleet in the terminal year of the assessment. Selectivity (blue line) and retention (red line) vary, while discard mortality (orange line) is constant.

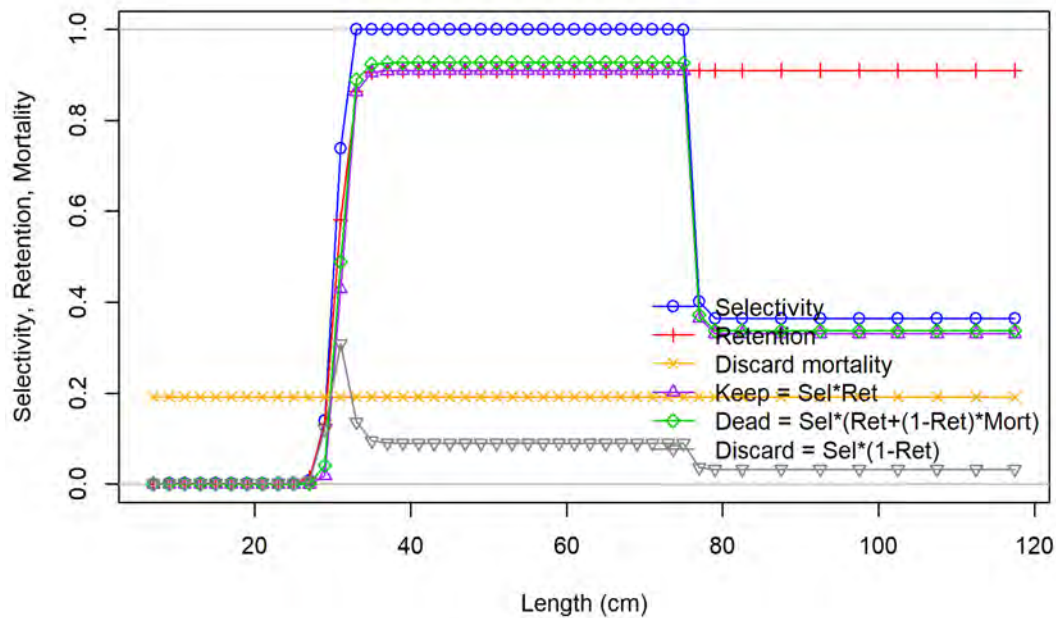


Figure 99. Length-based selectivity and retention for the Commercial Handline Central fleet in the terminal year of the assessment. Selectivity (blue line) and retention (red line) vary, while discard mortality (orange line) is constant.

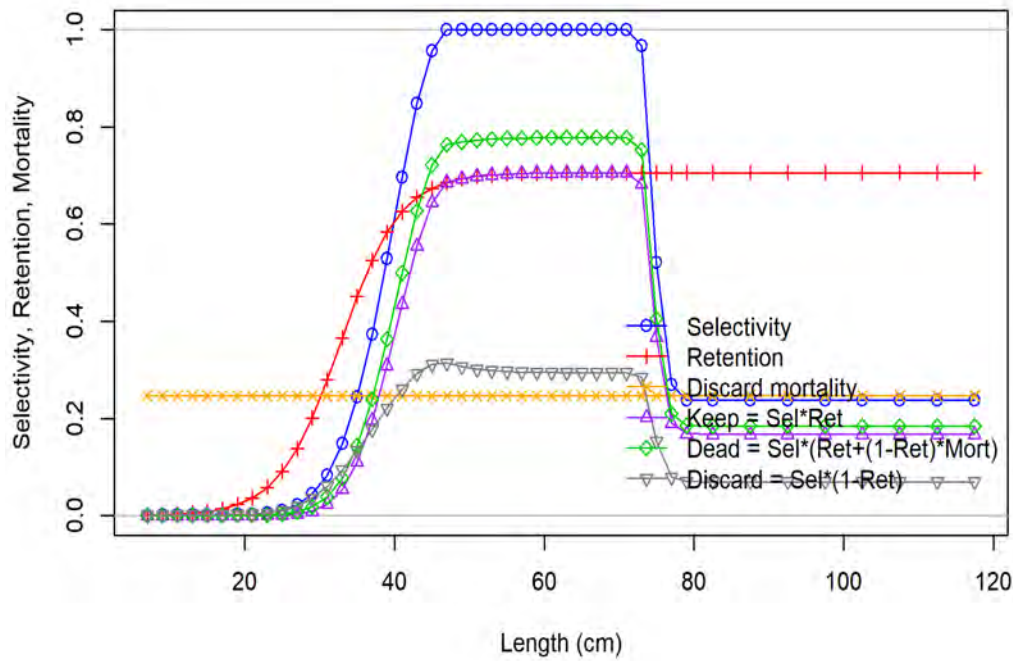


Figure 100. Length-based selectivity and retention for the Commercial Handline East fleet in the terminal year of the assessment. Selectivity (blue line) and retention (red line) vary, while discard mortality (orange line) is constant.

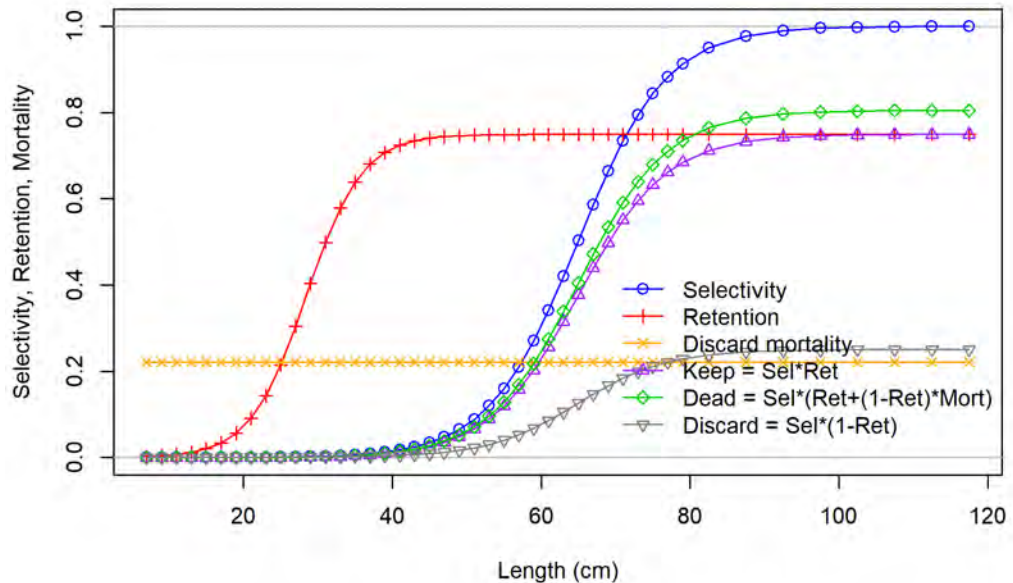


Figure 101. Length-based selectivity and retention for the Commercial Longline West fleet in the terminal year of the assessment. Selectivity (blue line) and retention (red line) vary, while discard mortality (orange line) is constant.

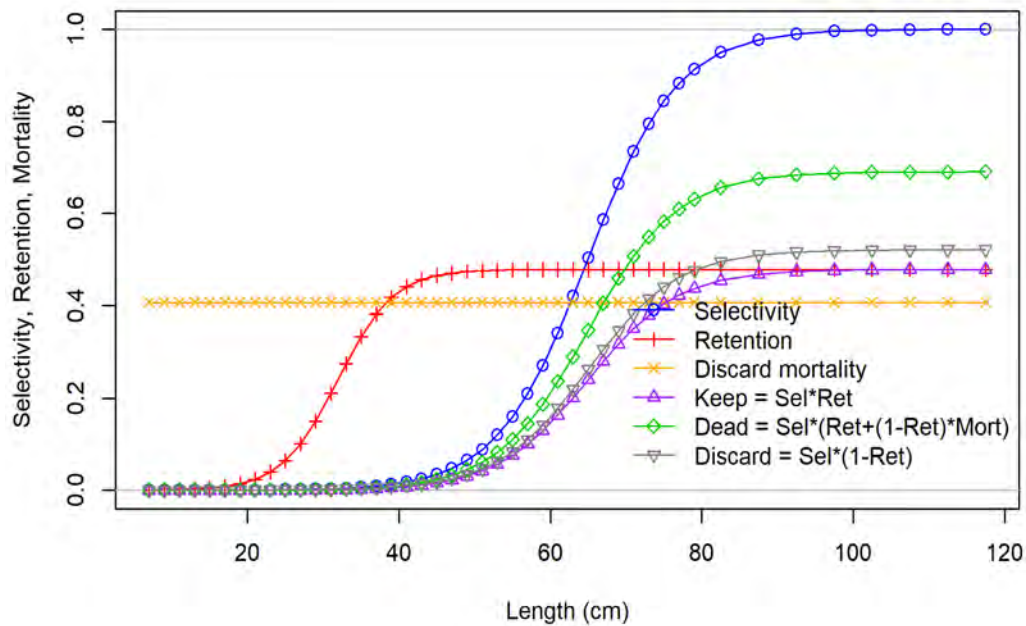


Figure 102. Length-based selectivity and retention for the Commercial Longline Central fleet in the terminal year of the assessment. Selectivity (blue line) and retention (red line) vary, while discard mortality (orange line) is constant.

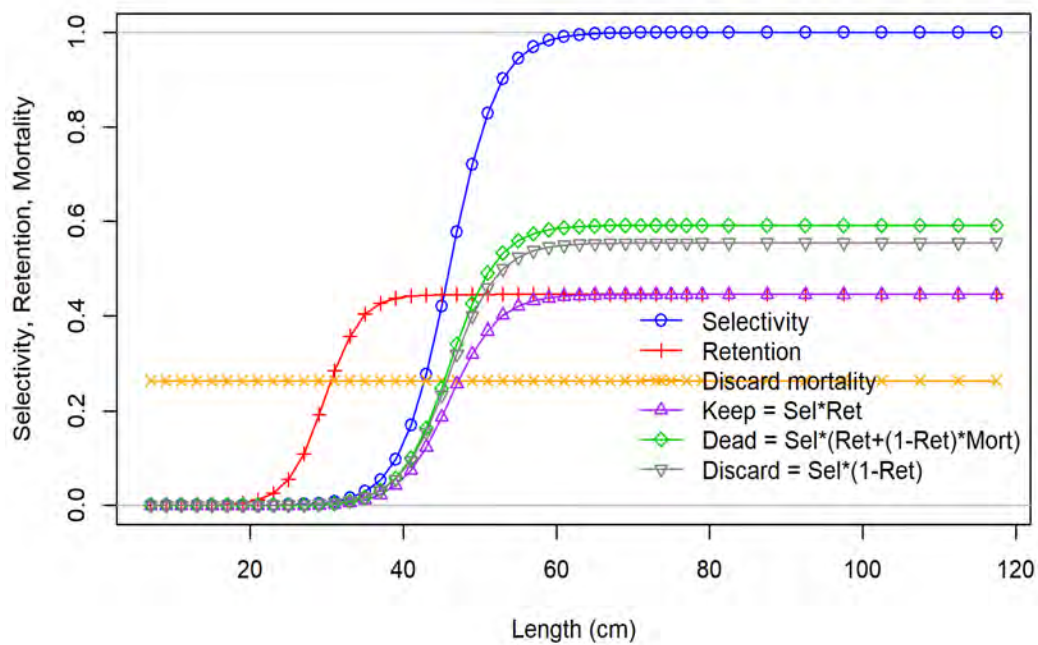


Figure 103. Length-based selectivity and retention for the Commercial Longline East fleet in the terminal year of the assessment. Selectivity (blue line) and retention (red line) vary, while discard mortality (orange line) is constant.



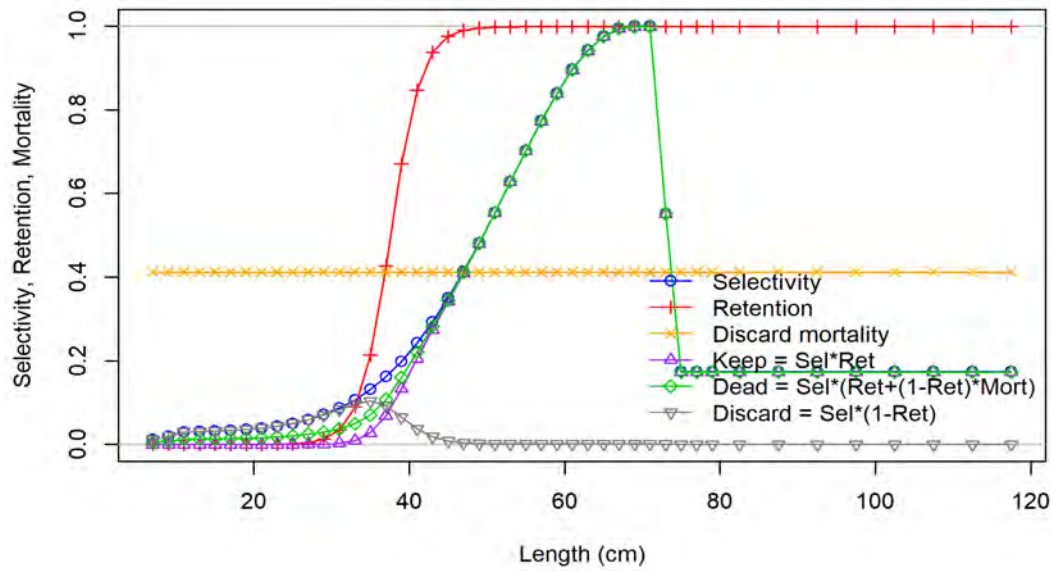


Figure 104. Length-based selectivity and retention for the Recreational Charter West fleet in the terminal year of the assessment. Selectivity (blue line) and retention (red line) vary, while discard mortality (orange line) is constant.

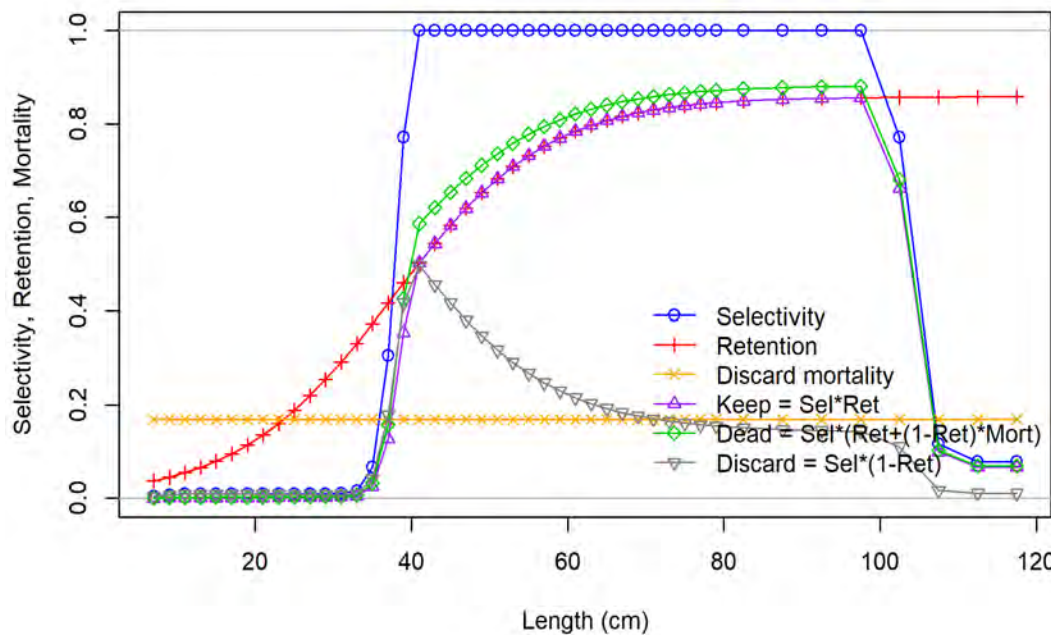


Figure 105. Length-based selectivity and retention for the Recreational Charter Central fleet in the terminal year of the assessment. Selectivity (blue line) and retention (red line) vary, while discard mortality (orange line) is constant.

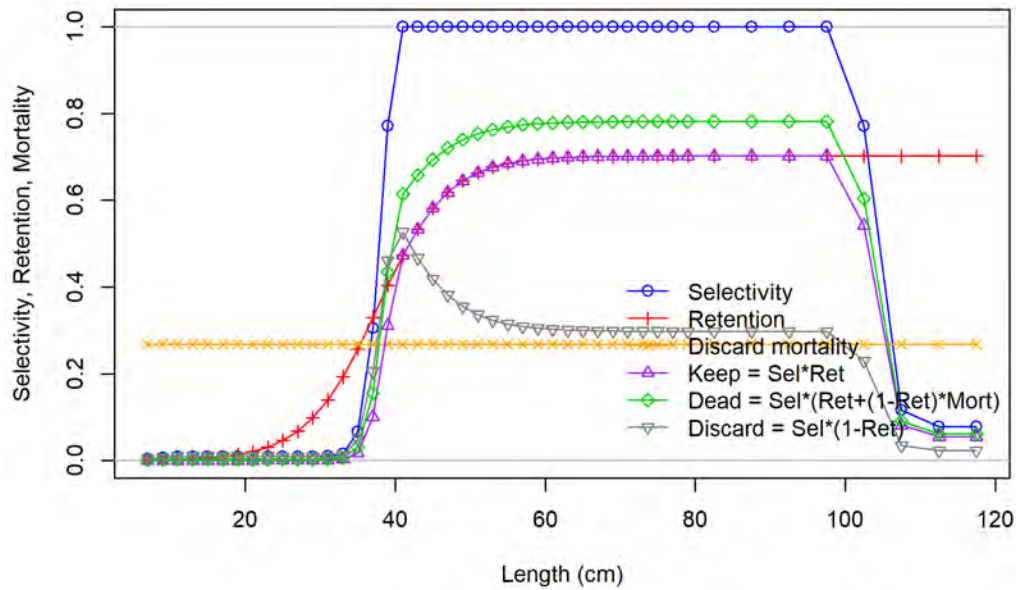


Figure 106. Length-based selectivity and retention for the Recreational Charter East fleet in the terminal year of the assessment. Selectivity (blue line) and retention (red line) vary, while discard mortality (orange line) is constant.

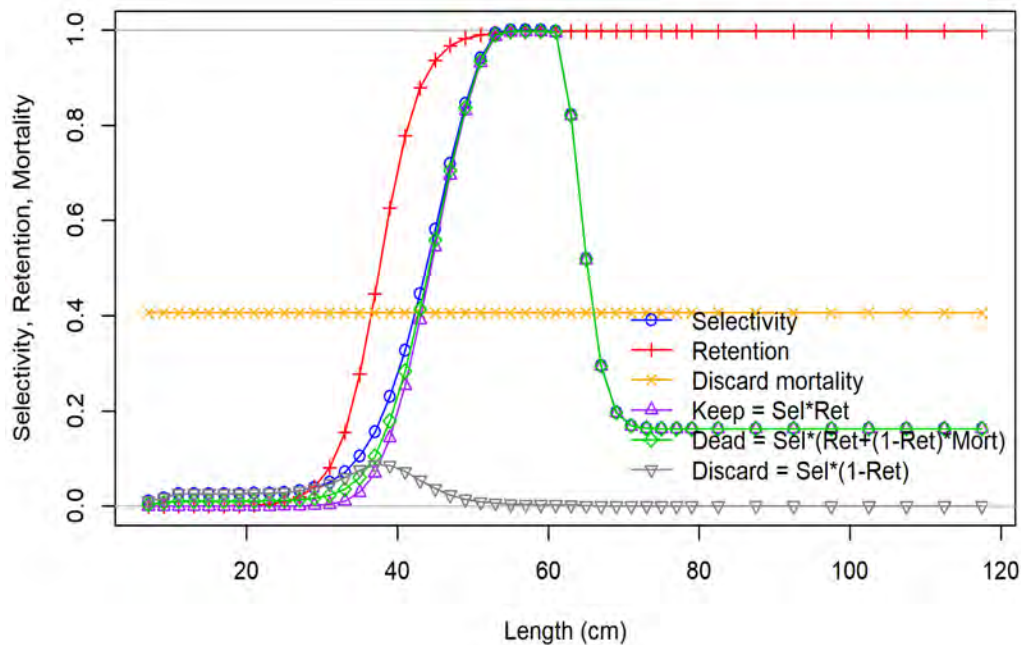


Figure 107. Length-based selectivity and retention for the Recreational Headboat West fleet in the terminal year of the assessment. Selectivity (blue line) and retention (red line) vary, while discard mortality (orange line) is constant.

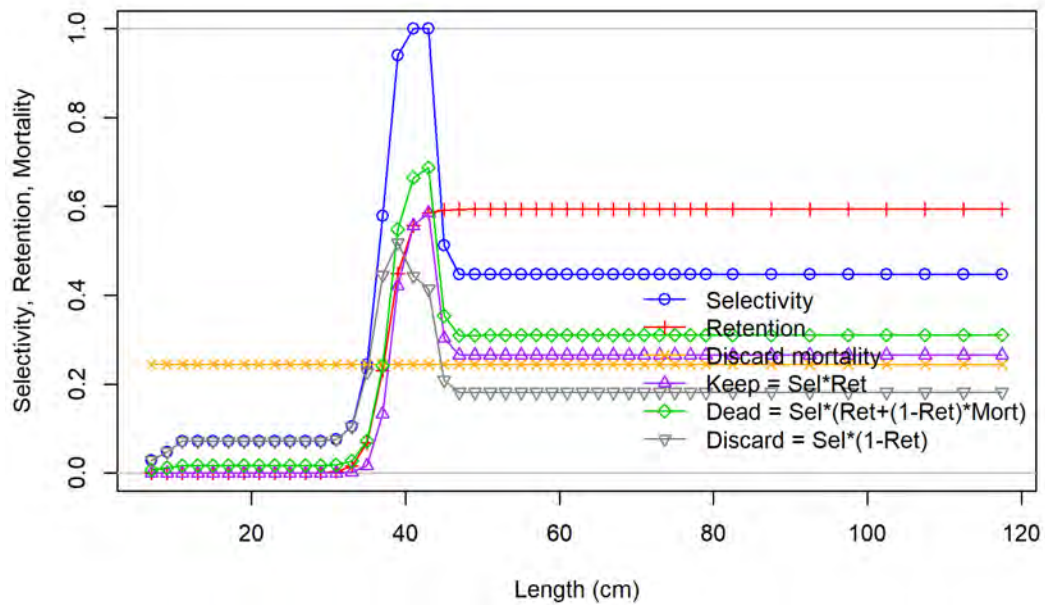


Figure 108. Length-based selectivity and retention for the Recreational Headboat Central fleet in the terminal year of the assessment. Selectivity (blue line) and retention (red line) vary, while discard mortality (orange line) is constant.

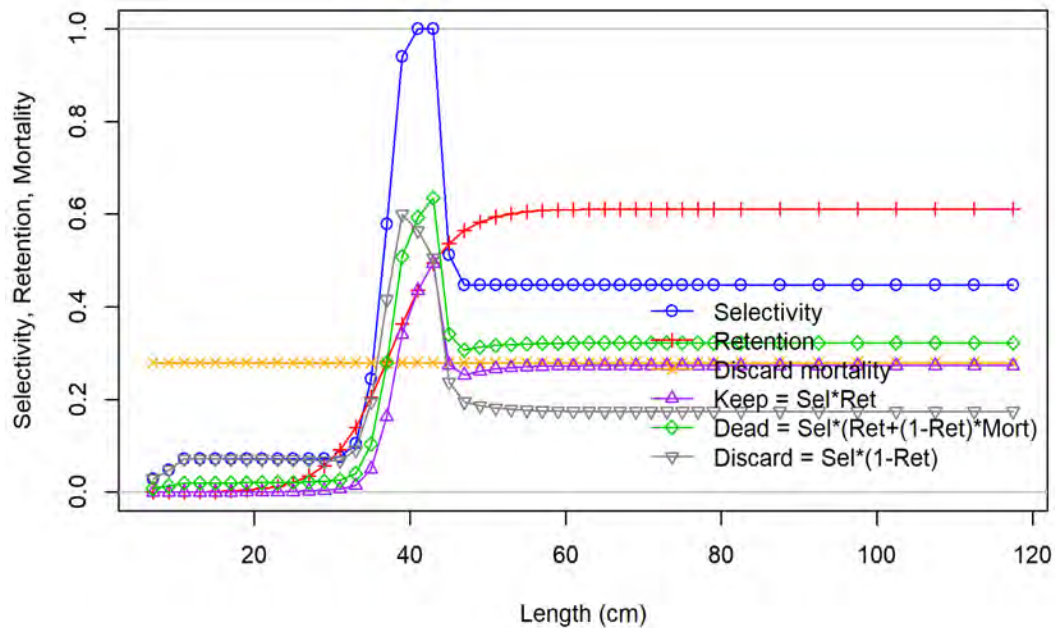


Figure 109. Length-based selectivity and retention for the Recreational Headboat East fleet in the terminal year of the assessment. Selectivity (blue line) and retention (red line) vary, while discard mortality (orange line) is constant.



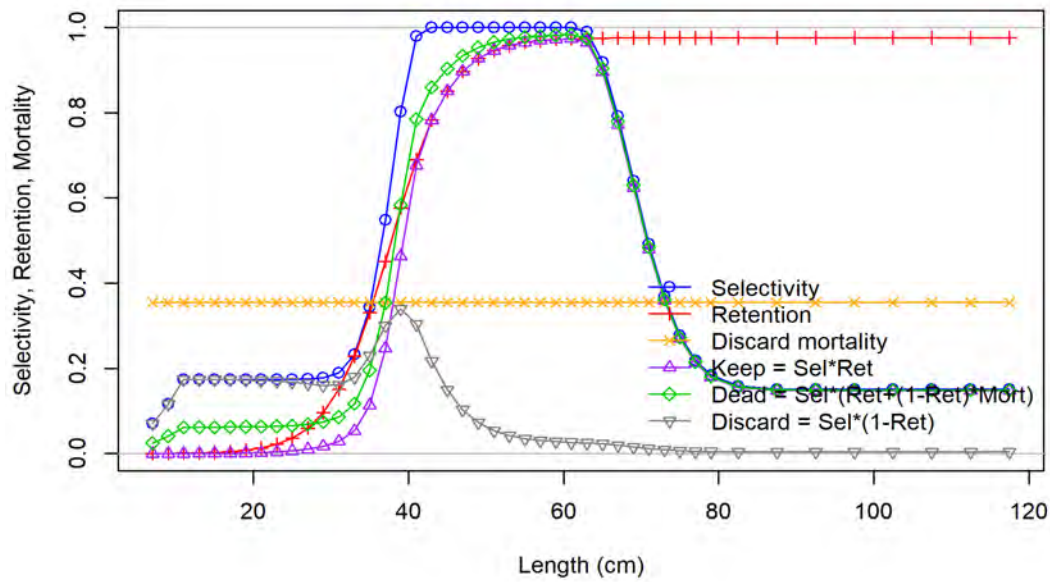


Figure 110. Length-based selectivity and retention for the Recreational Private West fleet in the terminal year of the assessment. Selectivity (blue line) and retention (red line) vary, while discard mortality (orange line) is constant.

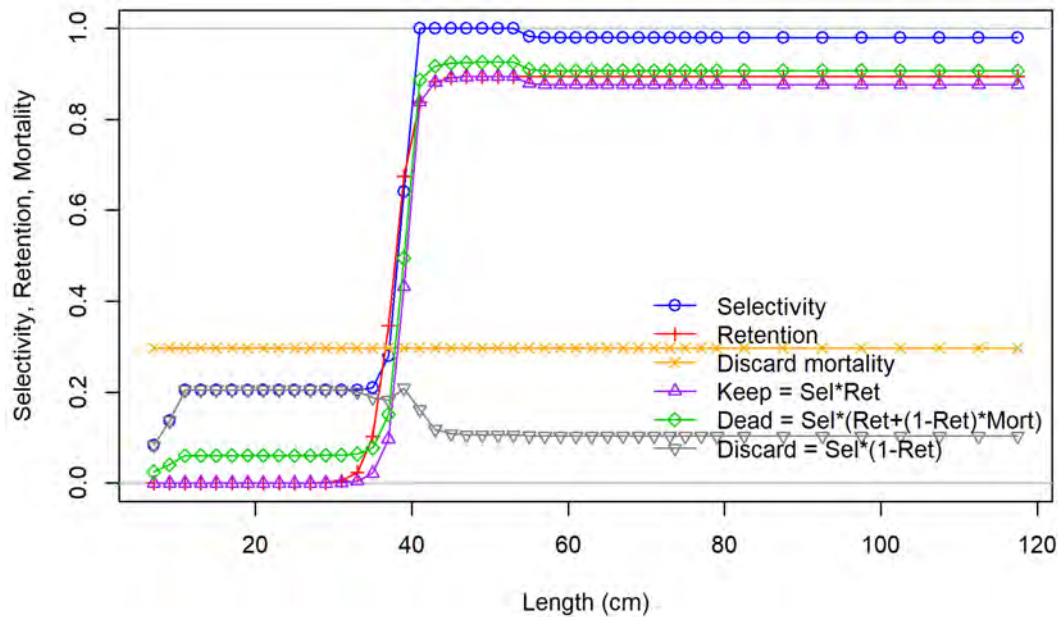


Figure 111. Length-based selectivity and retention for the Recreational Private Central fleet in the terminal year of the assessment. Selectivity (blue line) and retention (red line) vary, while discard mortality (orange line) is constant.

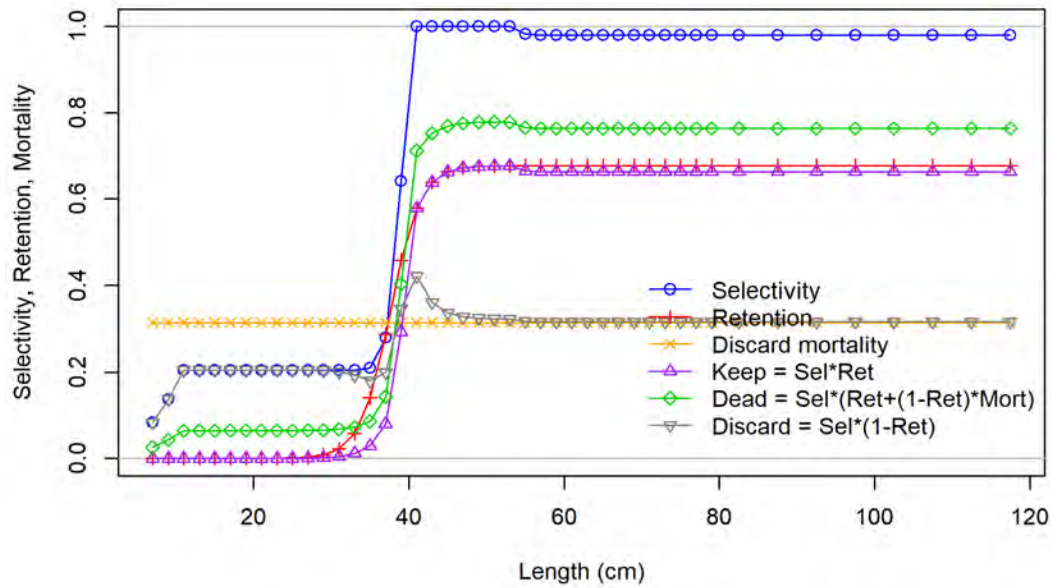


Figure 112. Length-based selectivity and retention for the Recreational Private East fleet in the terminal year of the assessment. Selectivity (blue line) and retention (red line) vary, while discard mortality (orange line) is constant.

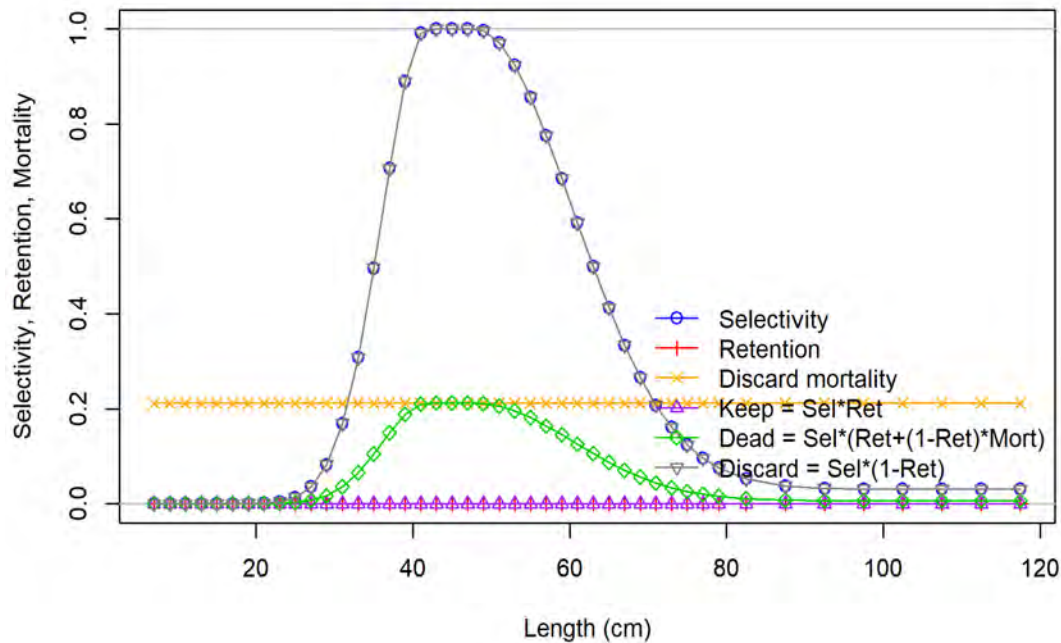


Figure 113. Length-based selectivity and retention for the Commercial Handline Closed Season Discards West fleet in the terminal year of the assessment. Selectivity (blue line) and retention (red line) vary, while discard mortality (orange line) is constant.

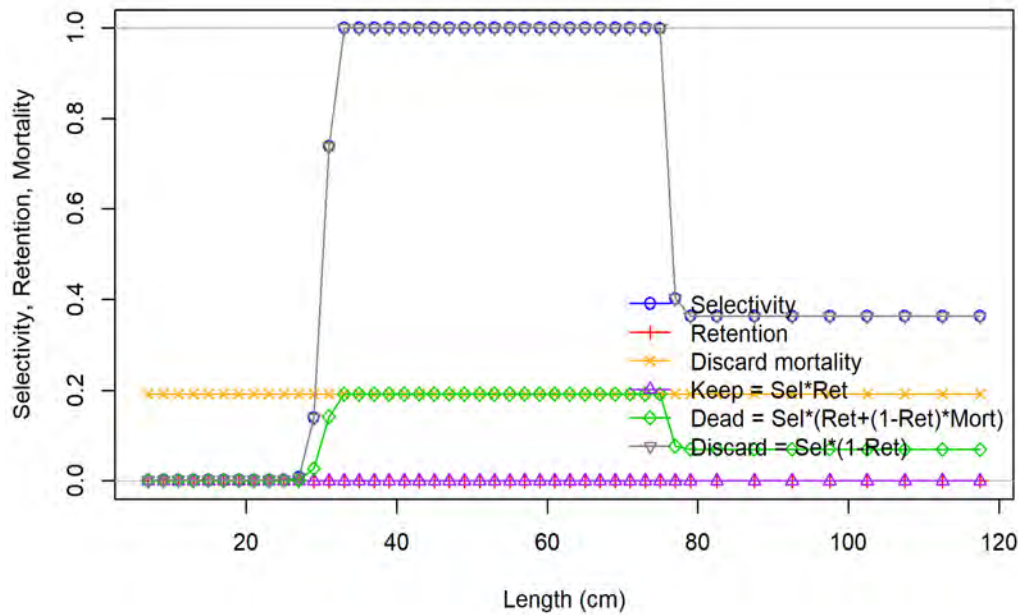


Figure 114. Length-based selectivity and retention for the Commercial Handline Closed Season Discards Central fleet in the terminal year of the assessment. Selectivity (blue line) and retention (red line) vary, while discard mortality (orange line) is constant.

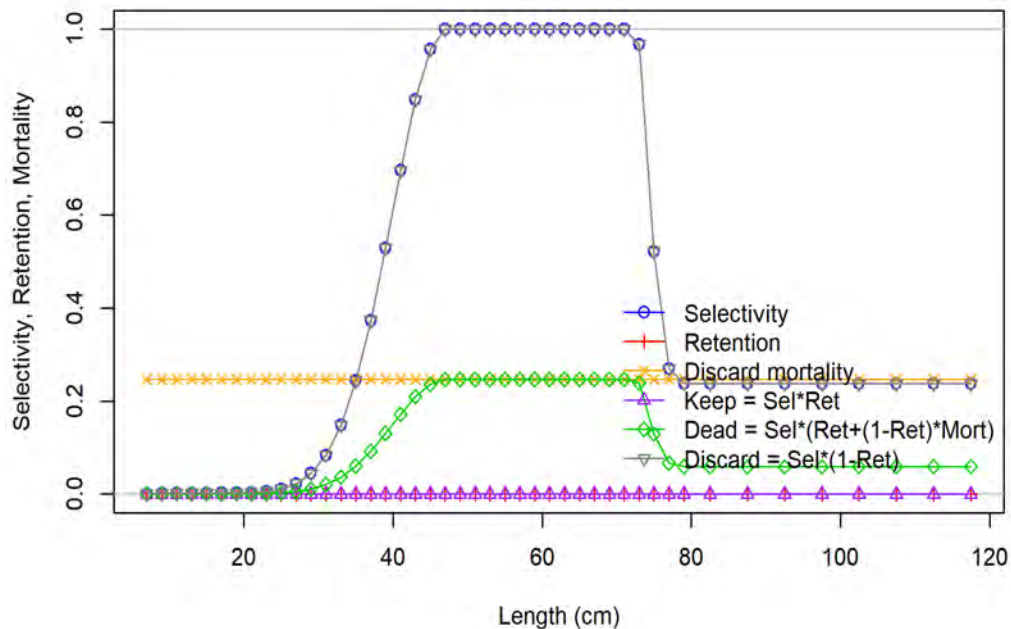


Figure 115. Length-based selectivity and retention for the Commercial Handline Closed Season Discards East fleet in the terminal year of the assessment. Selectivity (blue line) and retention (red line) vary, while discard mortality (orange line) is constant.

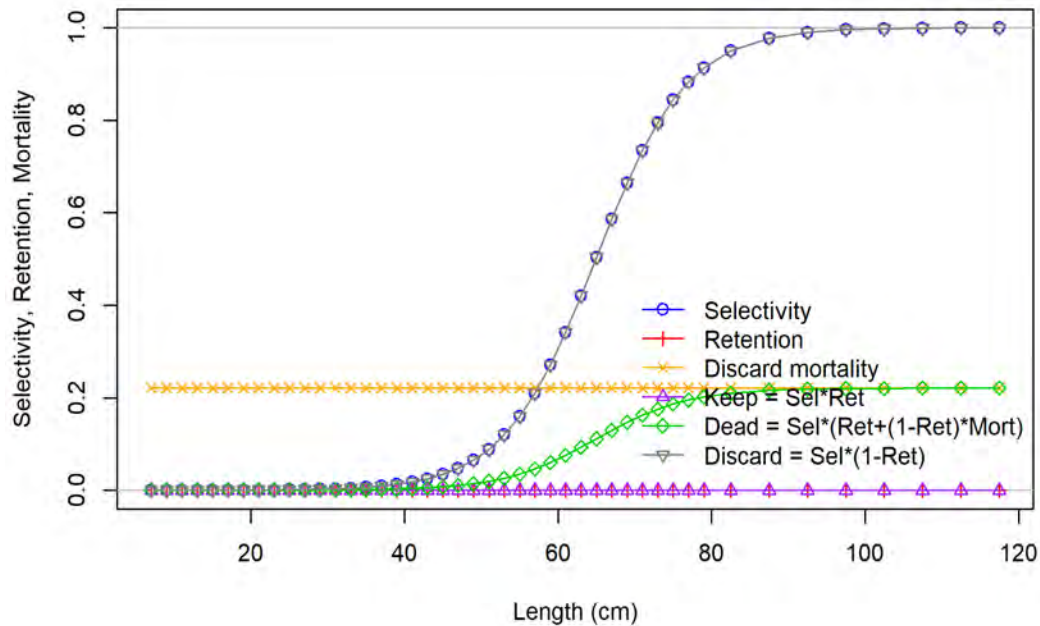


Figure 116. Length-based selectivity and retention for the Commercial Longline Closed Season Discards West fleet in the terminal year of the assessment. Selectivity (blue line) and retention (red line) vary, while discard mortality (orange line) is constant.

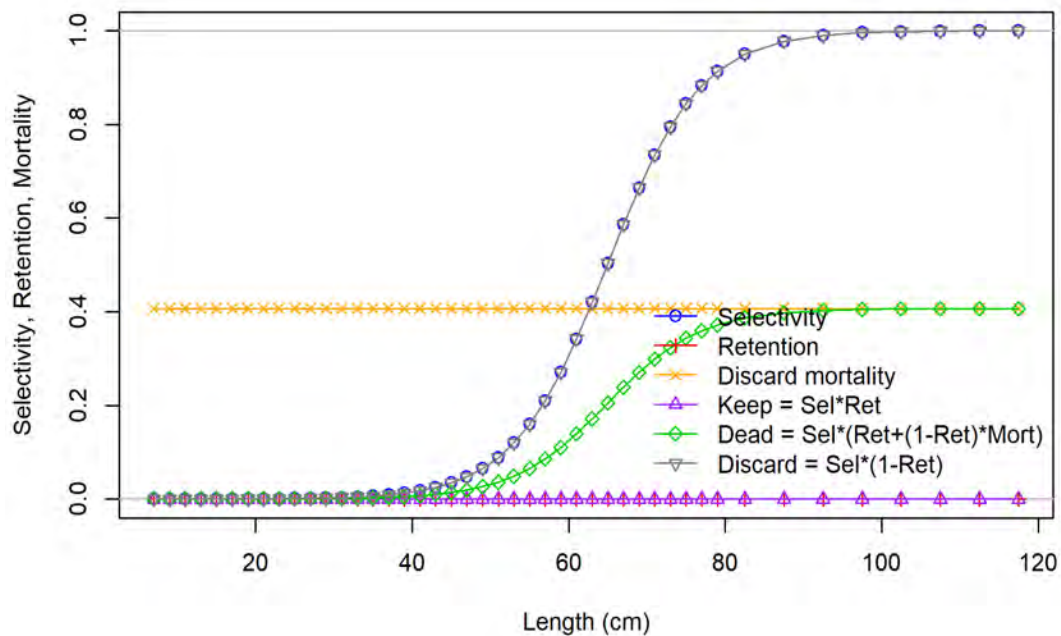


Figure 117. Length-based selectivity and retention for the Commercial Longline Closed Season Discards Central fleet in the terminal year of the assessment. Selectivity (blue line) and retention (red line) vary, while discard mortality (orange line) is constant.



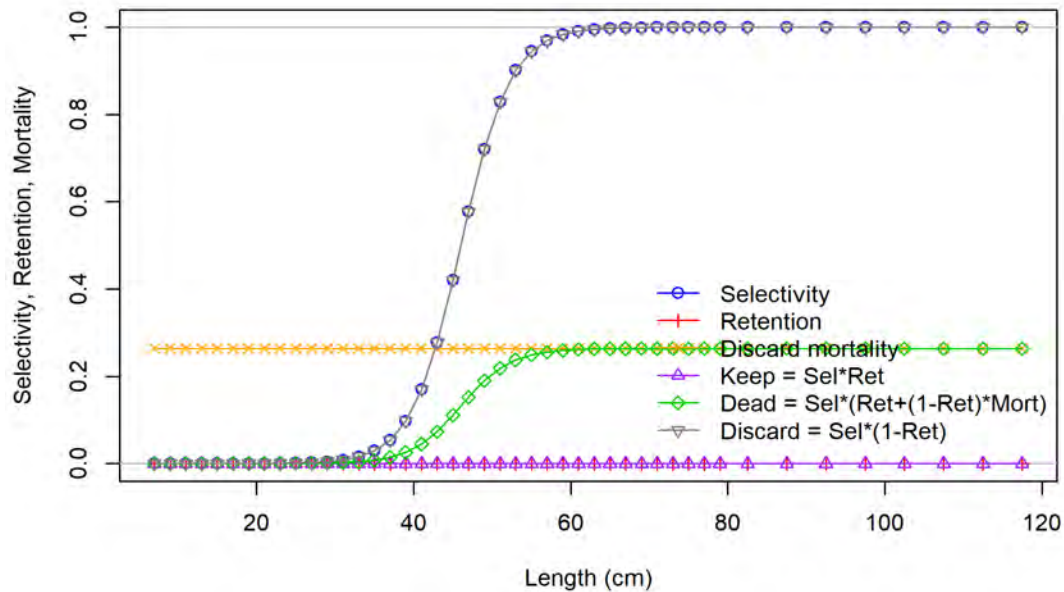


Figure 118. Length-based selectivity and retention for the Commercial Longline Closed Season Discards East fleet in the terminal year of the assessment. Selectivity (blue line) and retention (red line) vary, while discard mortality (orange line) is constant.

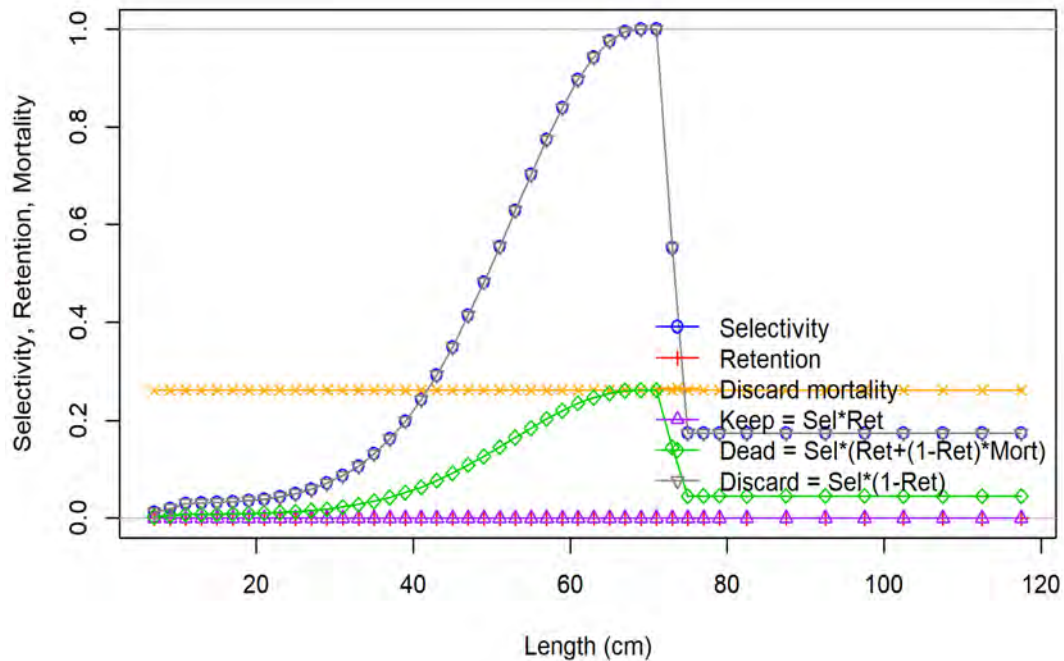


Figure 119. Length-based selectivity and retention for the Recreational Charter Closed Season Discards West fleet in the terminal year of the assessment. Selectivity (blue line) and retention (red line) vary, while discard mortality (orange line) is constant.

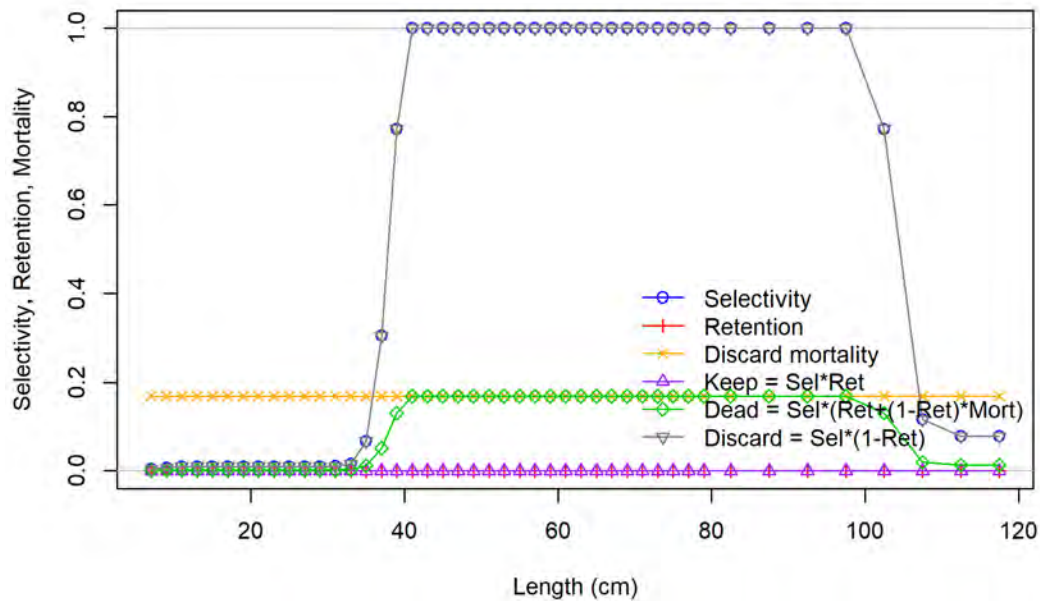


Figure 120. Length-based selectivity and retention for the Recreational Charter Closed Season Discards Central fleet in the terminal year of the assessment. Selectivity (blue line) and retention (red line) vary, while discard mortality (orange line) is constant.

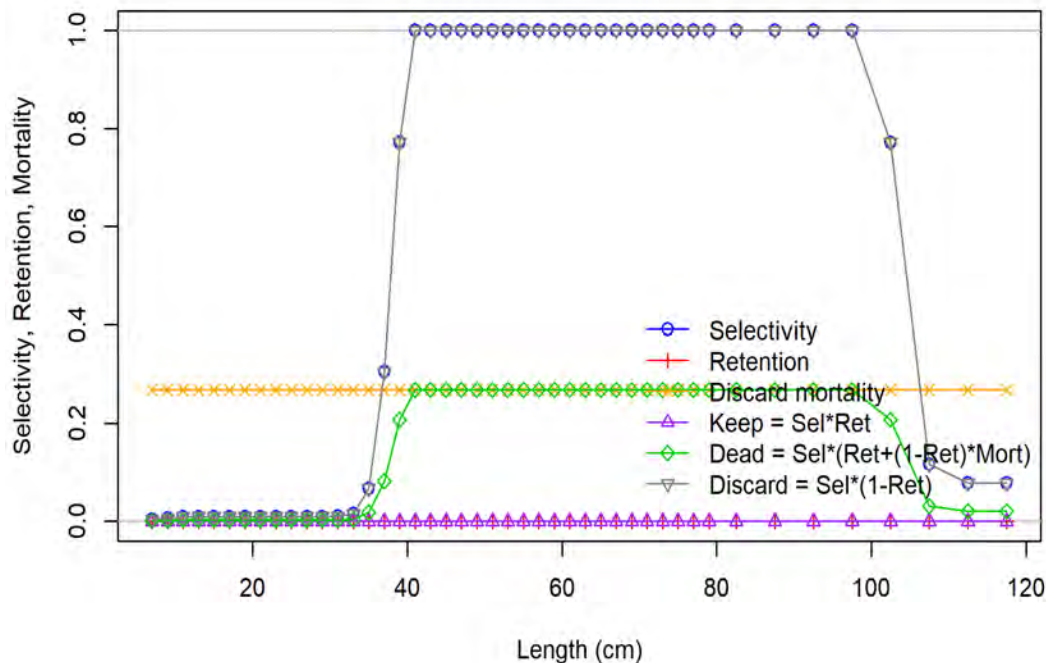


Figure 121. Length-based selectivity and retention for the Recreational Charter Closed Season Discards East fleet in the terminal year of the assessment. Selectivity (blue line) and retention (red line) vary, while discard mortality (orange line) is constant.

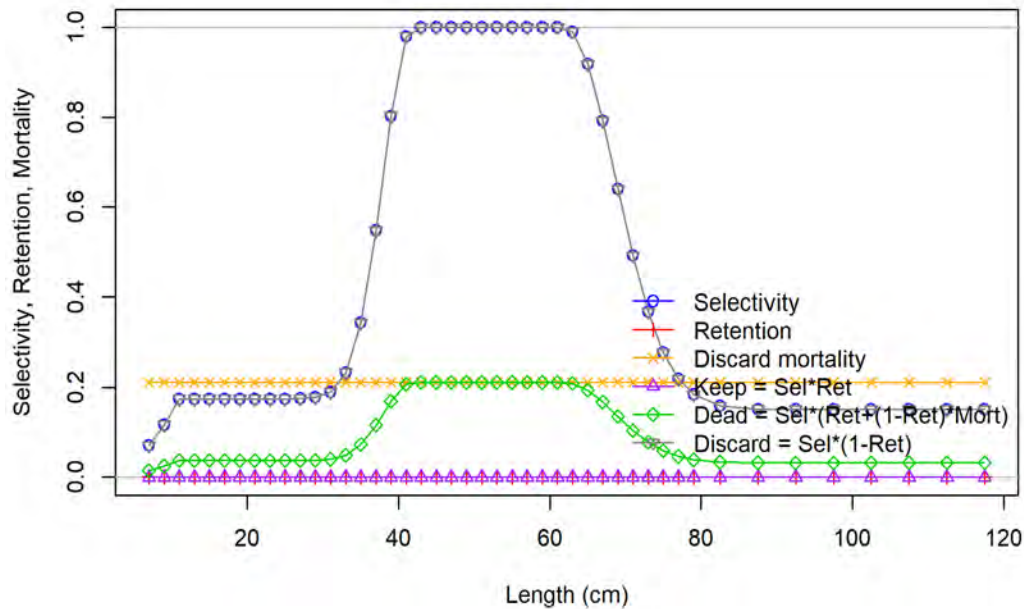


Figure 122. Length-based selectivity and retention for the Recreational Private Closed Season Discards West fleet in the terminal year of the assessment. Selectivity (blue line) and retention (red line) vary, while discard mortality (orange line) is constant.

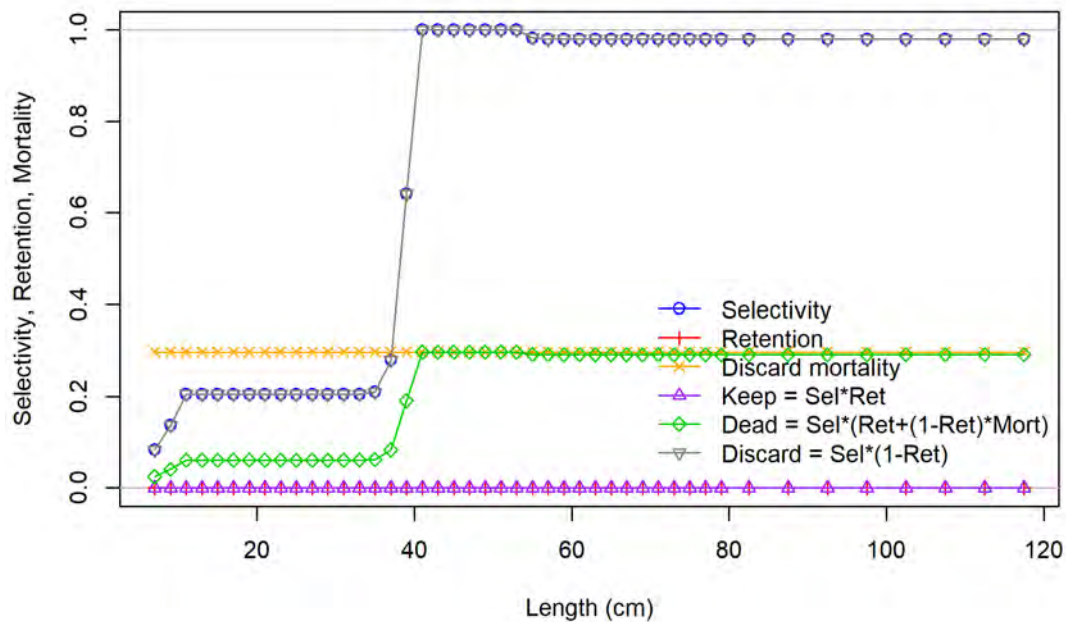


Figure 123. Length-based selectivity and retention for the Recreational Private Closed Season Discards Central fleet in the terminal year of the assessment. Selectivity (blue line) and retention (red line) vary, while discard mortality (orange line) is constant.

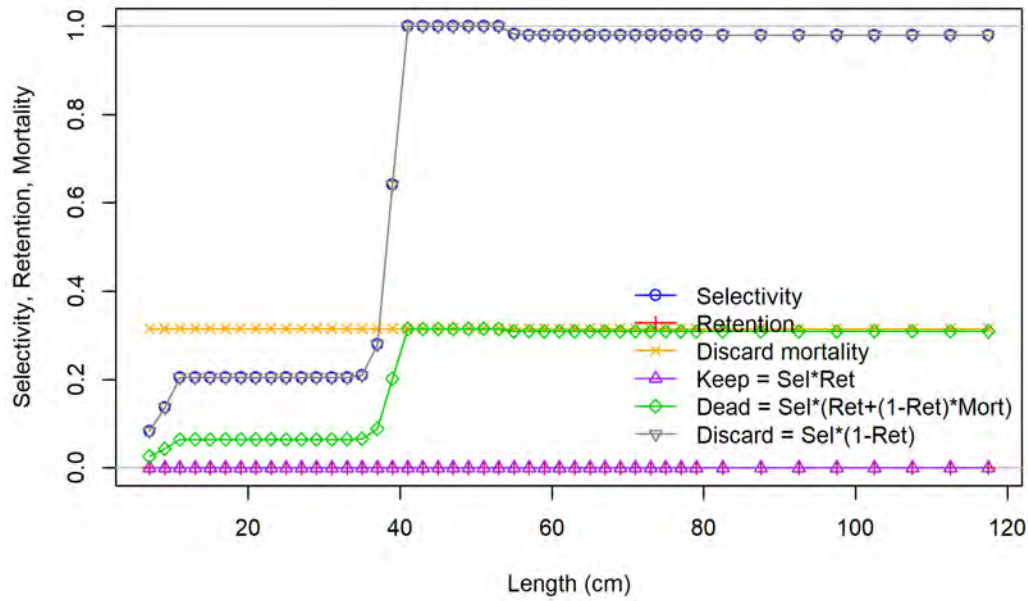


Figure 124. Length-based selectivity and retention for the Recreational Private Closed Season Discards East fleet in the terminal year of the assessment. Selectivity (blue line) and retention (red line) vary, while discard mortality (orange line) is constant.



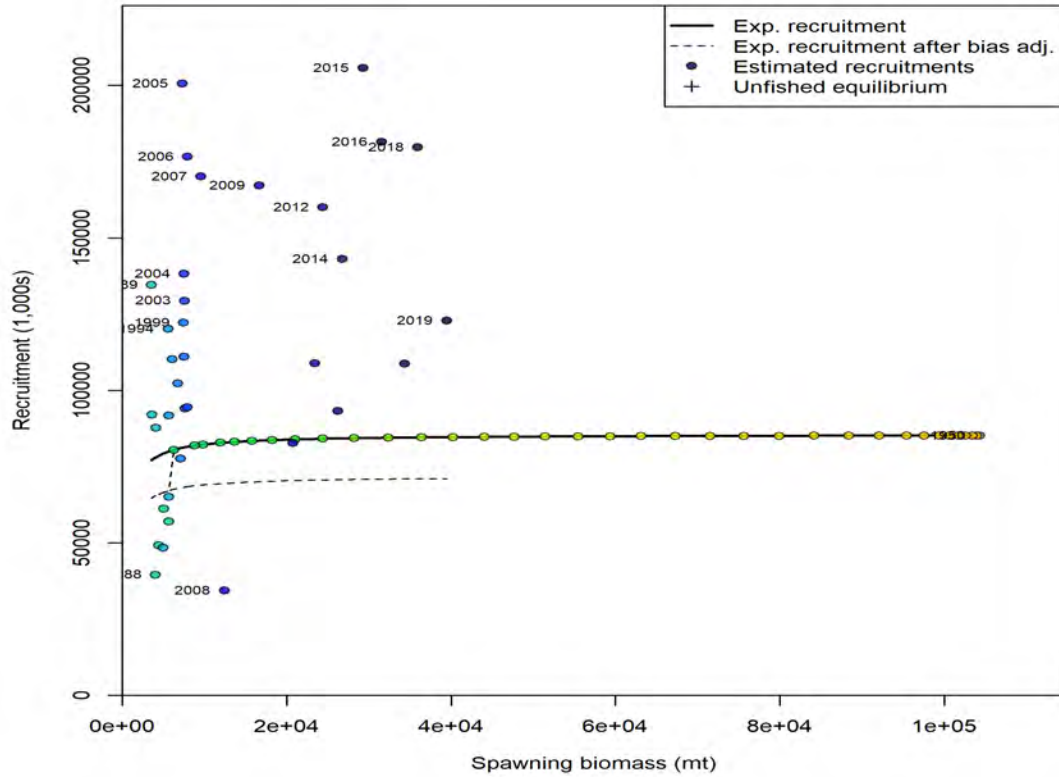


Figure 125. Stock-recruitment relationship for Gulf of Mexico Red Snapper with fixed steepness and  $\sigma_R$  at 0.99 and 0.6, respectively. Plotted are predicted annual recruitments from Stock Synthesis (circles), expected recruitment from the stock-recruit relationship (black line), and bias adjusted recruitment from the stock-recruit relationship (dashed line).

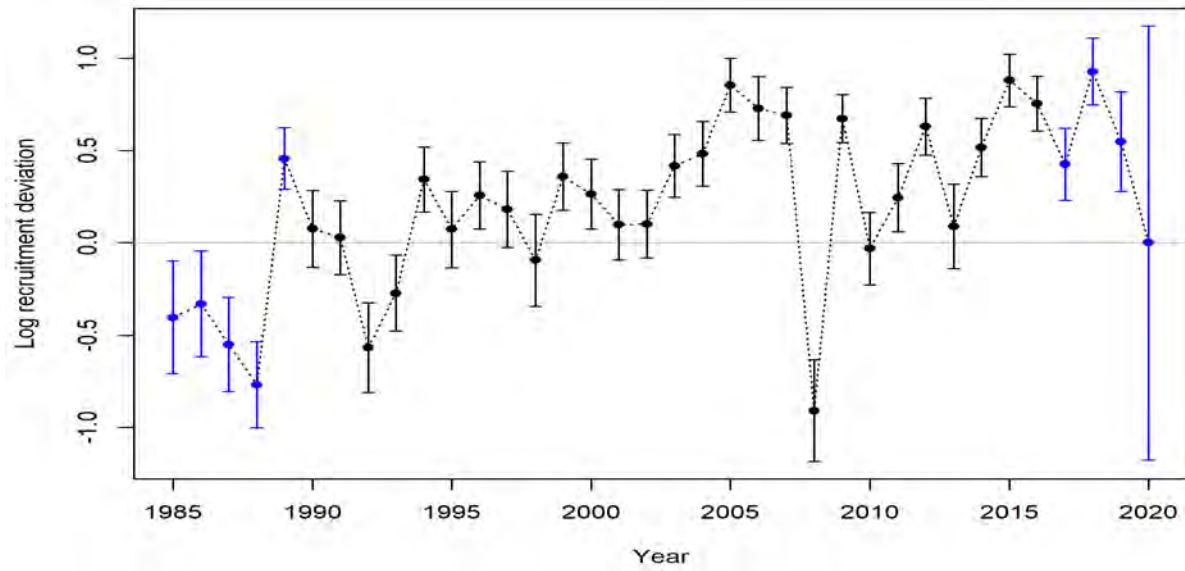


Figure 126. Estimated log recruitment deviations for Gulf of Mexico Red Snapper (steepness and SigmaR were fixed at 0.99 and 0.6, respectively).

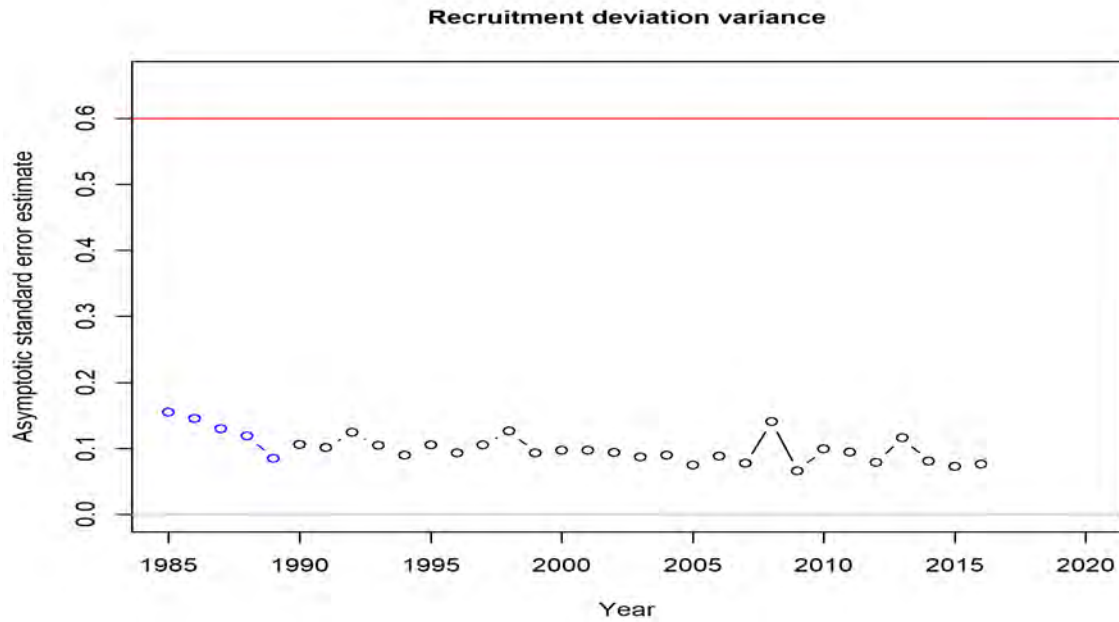


Figure 127. Asymptotic standard errors for recruitment deviations for Gulf of Mexico Red Snapper. The red line represents the fixed value of  $\sigma_R$  of 0.6 used in the SEDAR 74 model.

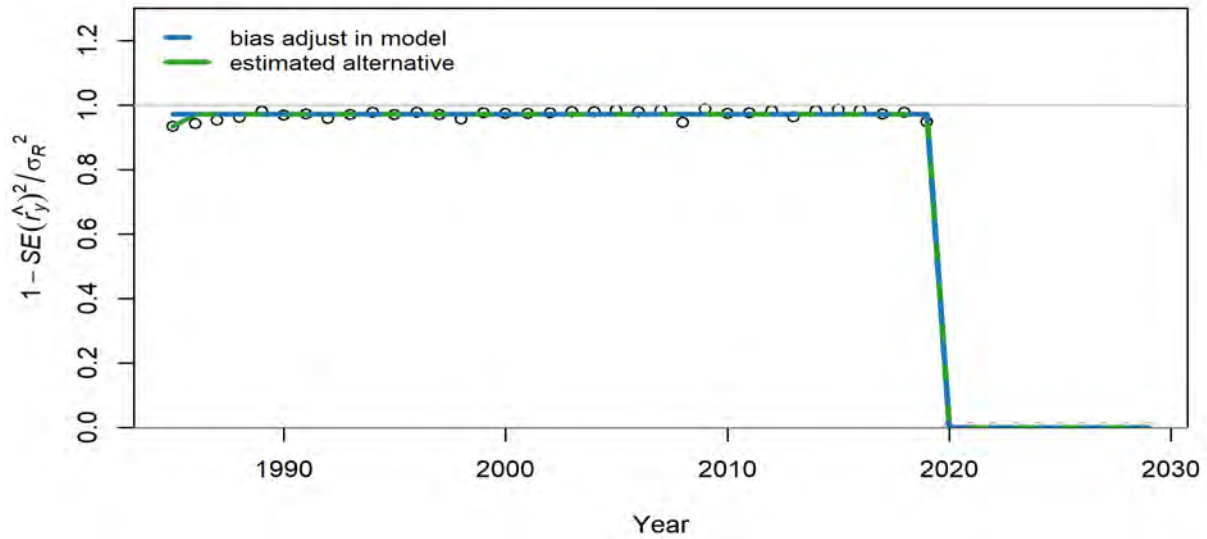


Figure 128. Points are transformed variances. The blue line shows current settings for bias adjustment specified for the Base Run, which coincides with the least squares estimate of alternative bias adjustment relationship for recruitment deviations (green line). For more information, see Methot and Taylor 2011.

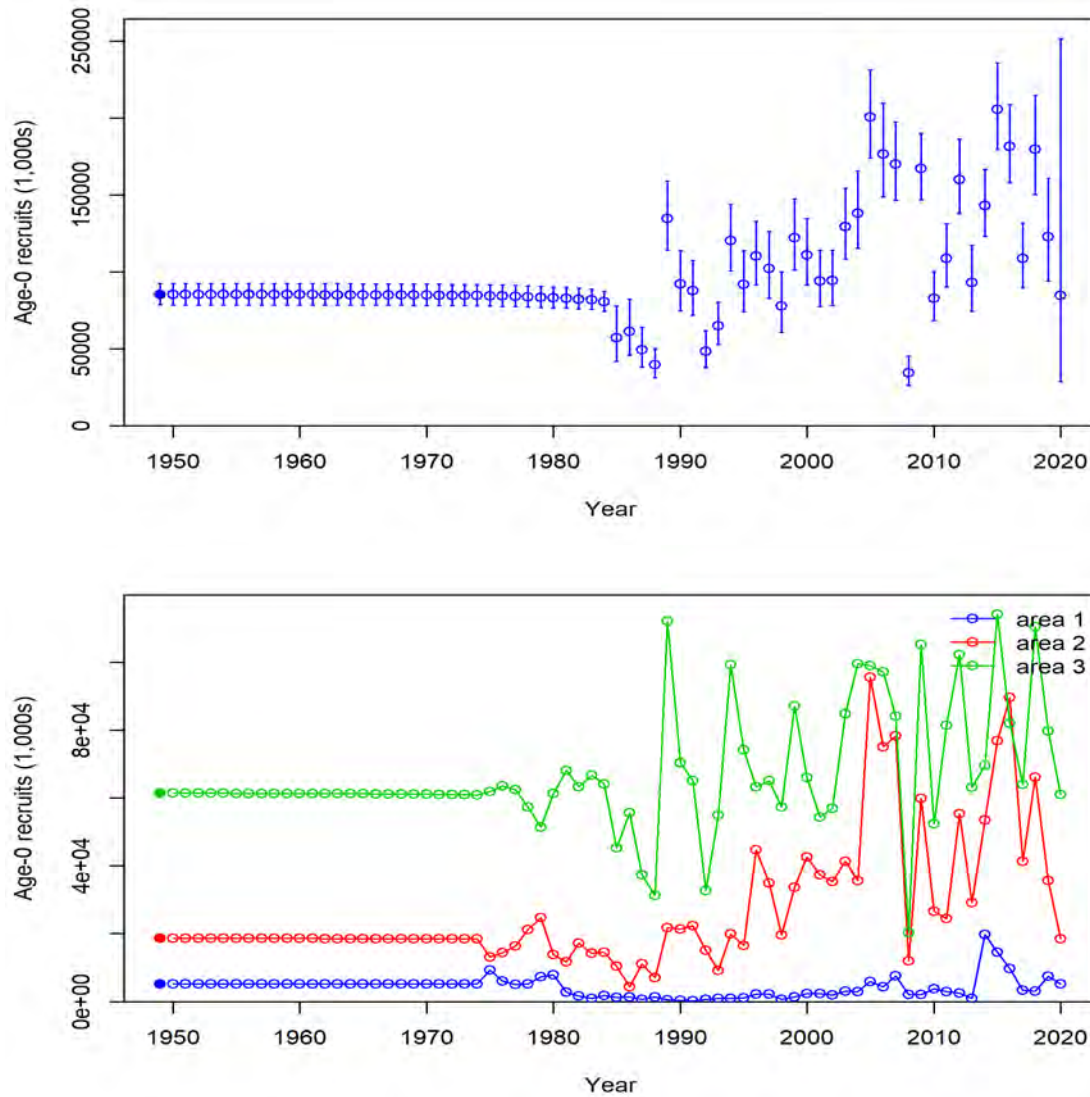


Figure 129. Estimated Age-0 recruitment with 95% confidence intervals for Gulf of Mexico Red Snapper (steepness and  $\Sigma R$  were fixed at 0.99 and 0.6, respectively). Bottom figure represents estimated age-0 recruitment by area with area 1 (blue) indicating trends in the east, area 2 (red) indicating trends in the central area, and area3 (green) indicating trends in the west area.

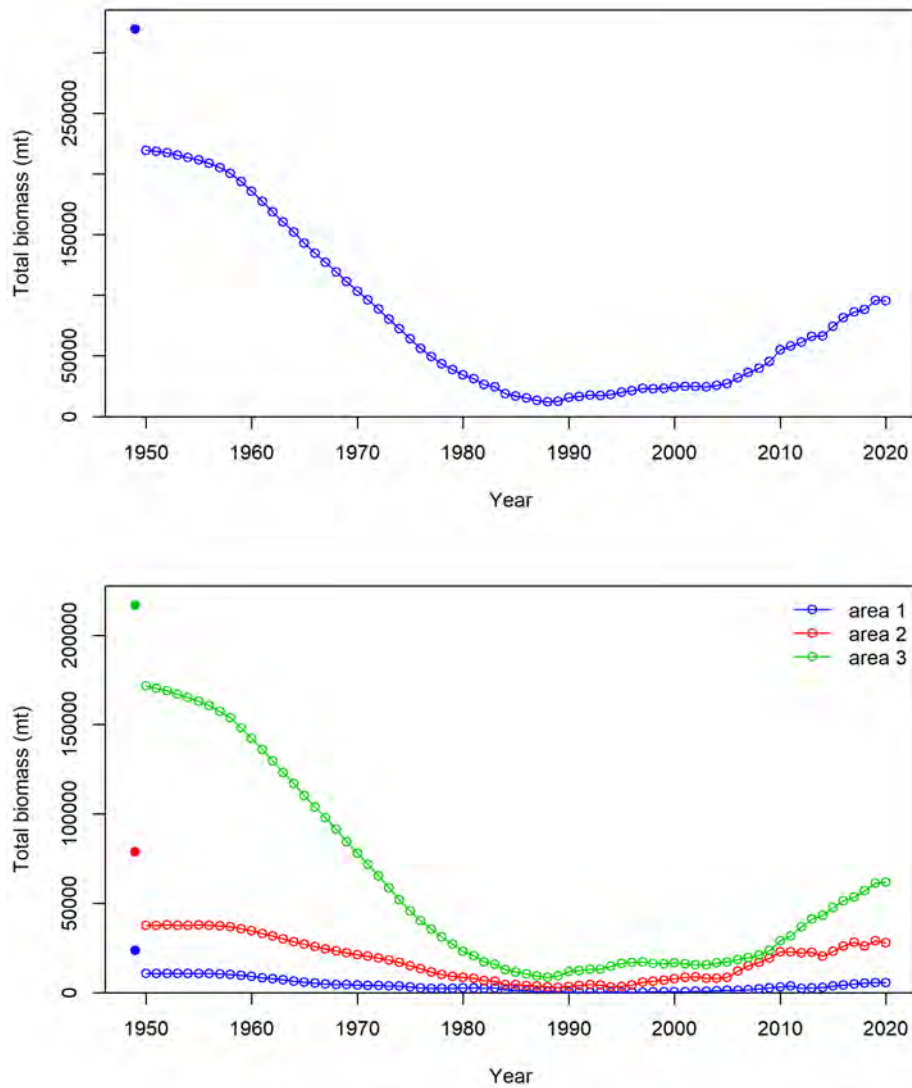


Figure 130. Estimate of total biomass (in metric tons) for Gulf of Mexico Red Snapper and by area with the blue, red and green lines representing the east, central and west areas, respectively.

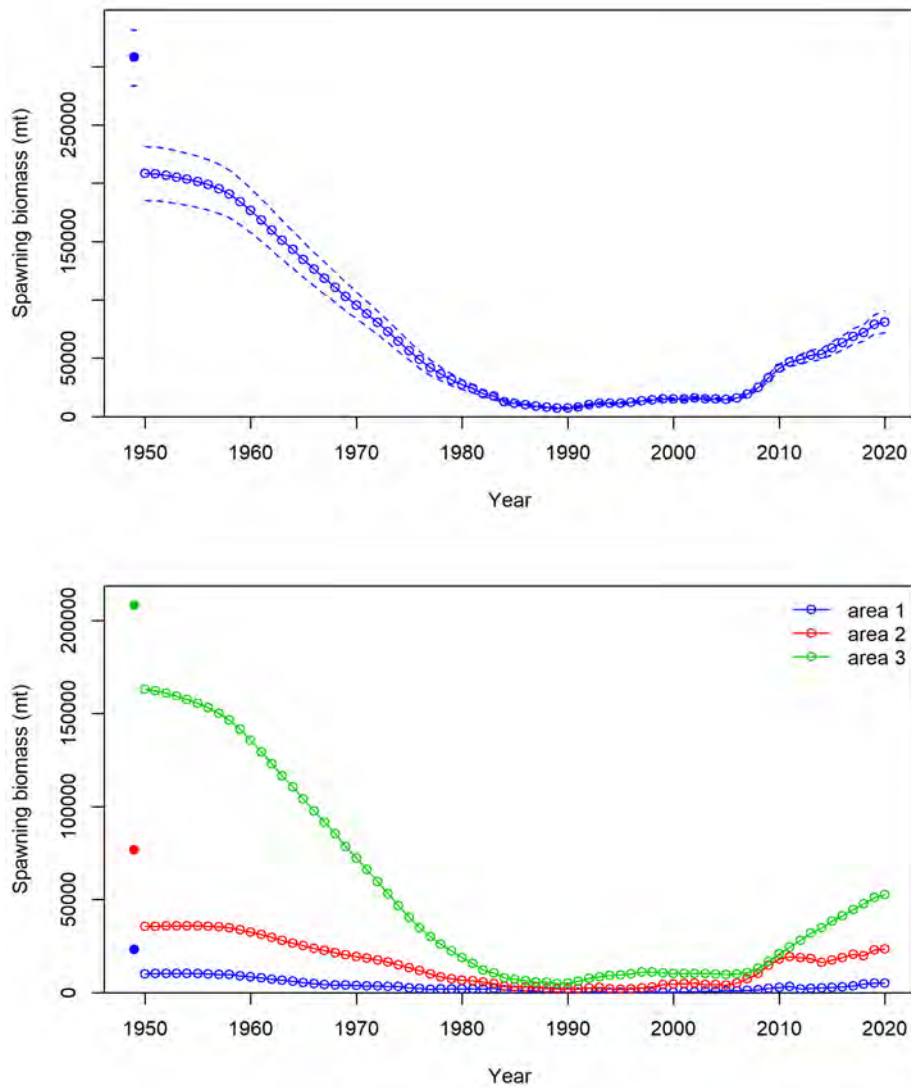


Figure 131. Estimate of spawning stock biomass (in metric tons) and associated 95% confidence intervals for Gulf of Mexico Red Snapper and by area with the blue, red and green lines representing the spawning stock biomass in the east, central and west area respectively.

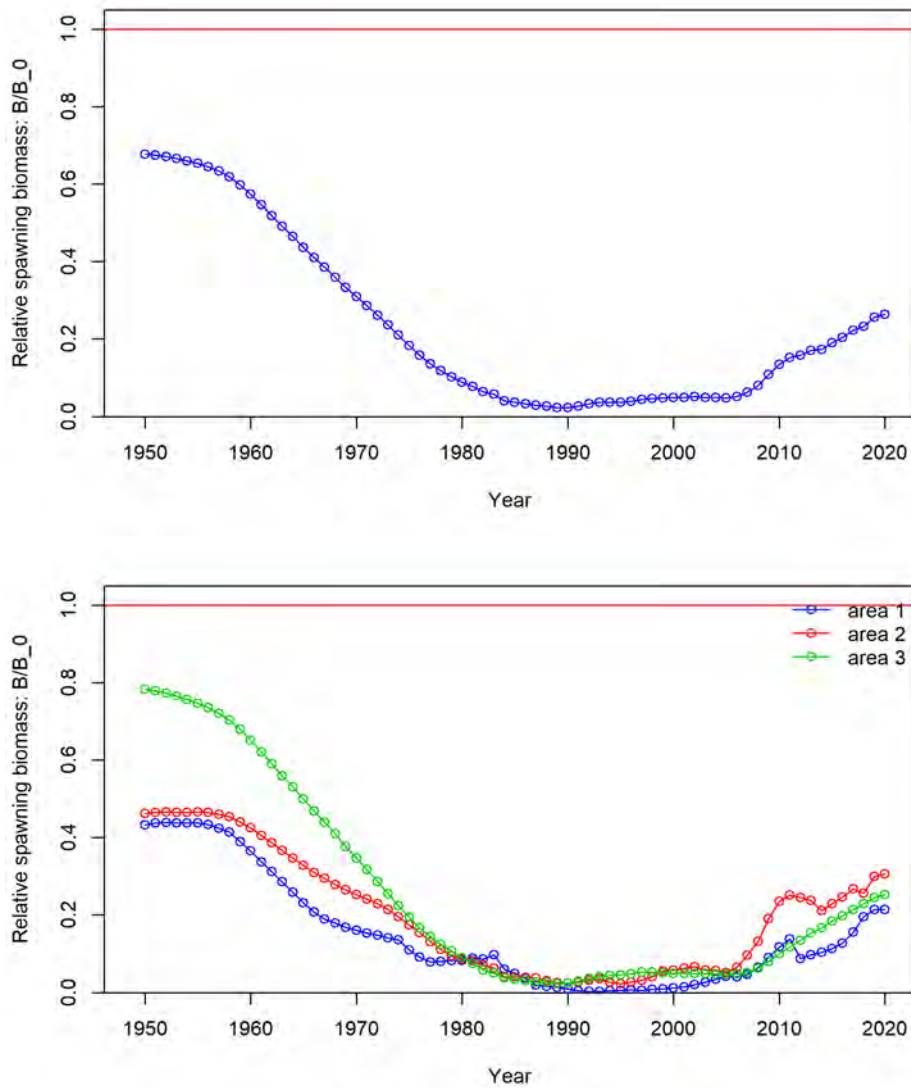


Figure 132. Estimates of fraction of unfished SSB ( $SSB/SSB_0$ ) for Gulf of Mexico Red Snapper and by area with the blue, red and green lines representing the east, central and west area respectively.



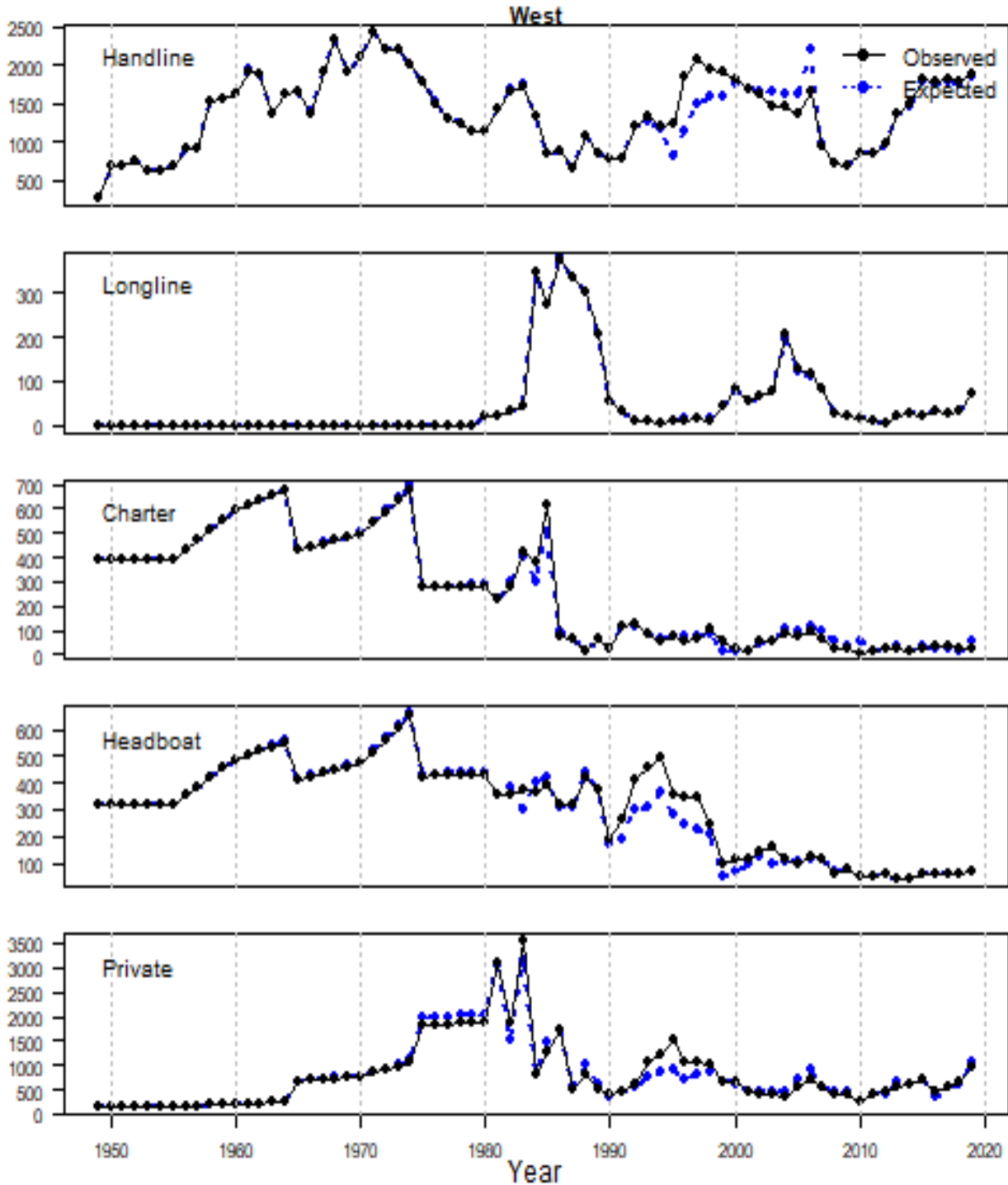


Figure 133. Western Gulf of Mexico Red Snapper observed and expected landings by fleet for SEDAR 74 . Commercial and recreational landings are in metric tons and thousands of fish, respectively. Dashed vertical lines identify ten year intervals.

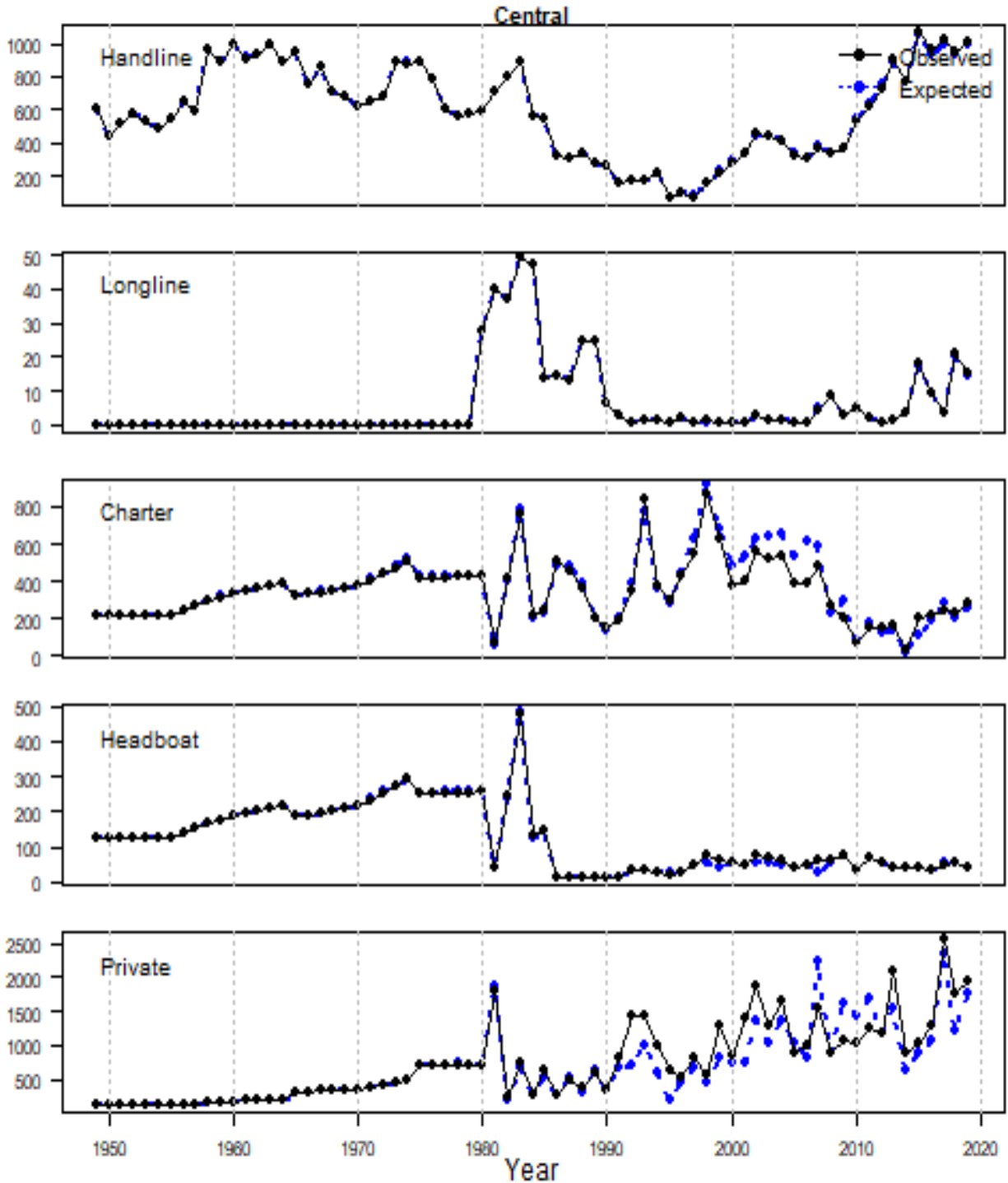


Figure 134. Central Gulf of Mexico Red Snapper observed and expected landings by fleet for SEDAR 74 . Commercial and recreational landings are in metric tons and thousands of fish, respectively. Dashed vertical lines identify ten year intervals.

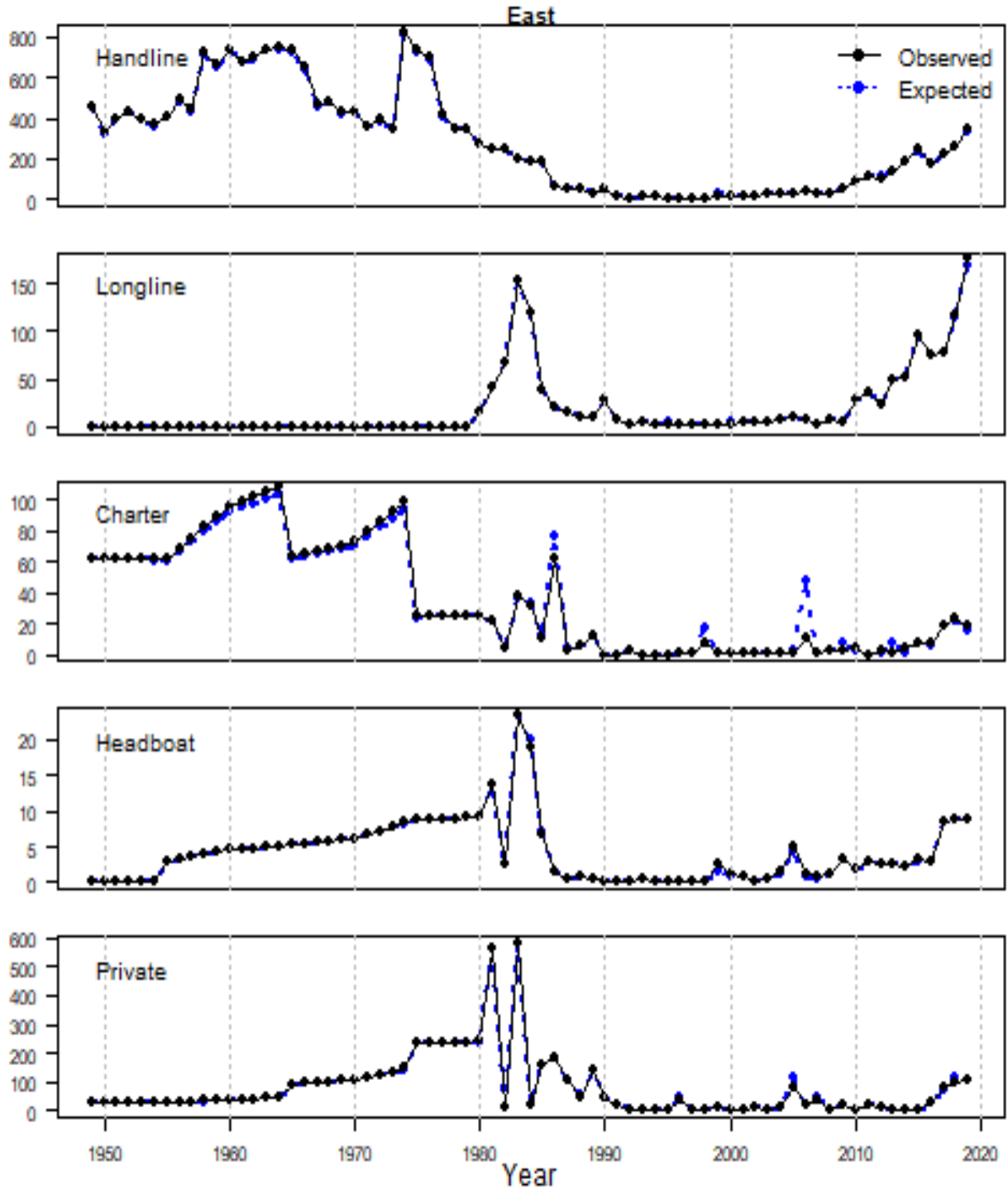


Figure 135. Eastern Gulf of Mexico Red Snapper observed and expected landings by fleet for SEDAR 74 . Commercial and recreational landings are in metric tons and thousands of fish, respectively. Dashed vertical lines identify ten year intervals.

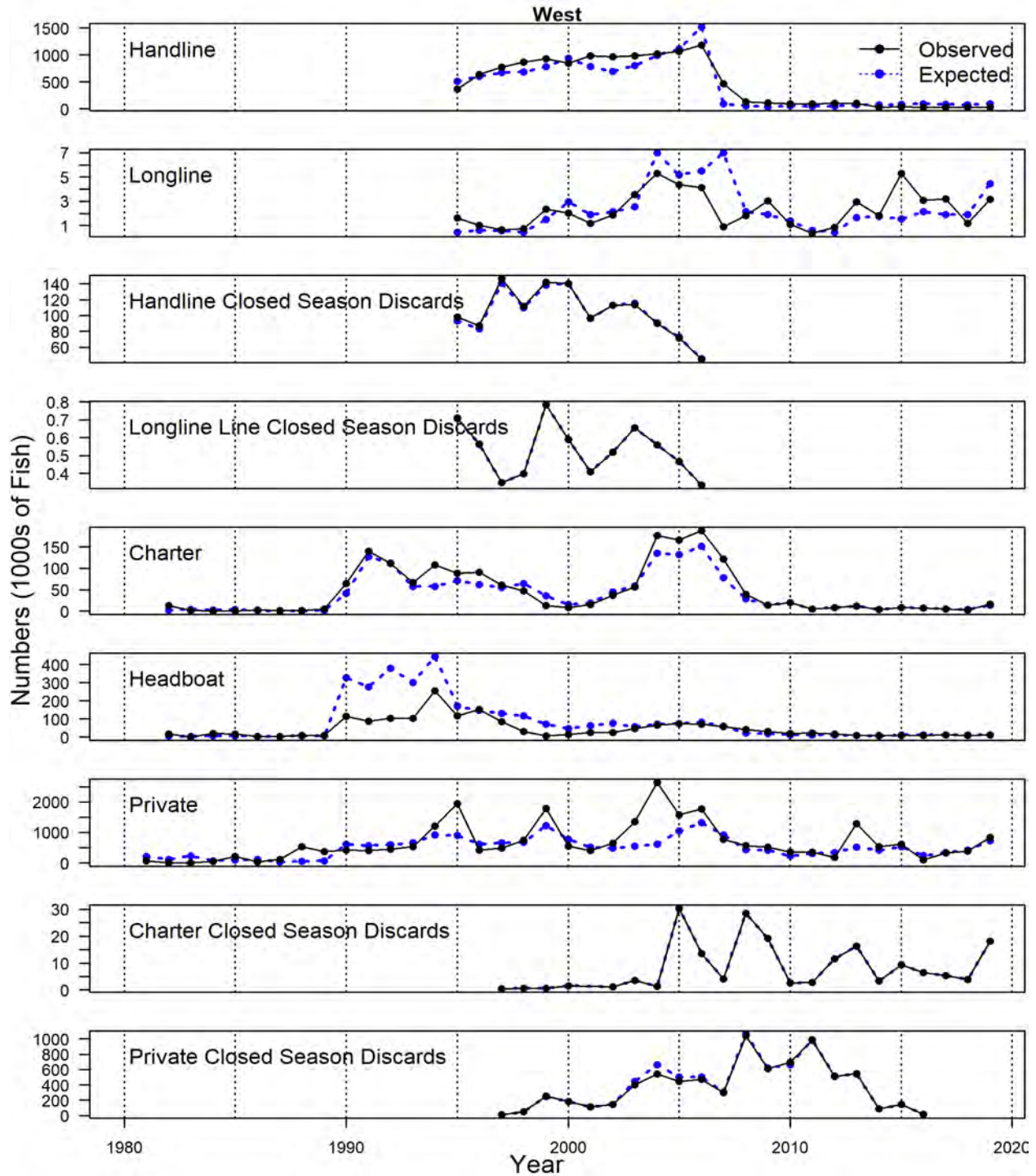


Figure 136. Western Gulf of Mexico Red Snapper observed and expected discards by fleet for SEDAR 74 (left panels). Commercial and recreational discards are in thousands of fish, respectively. Dashed vertical lines identify five year intervals.

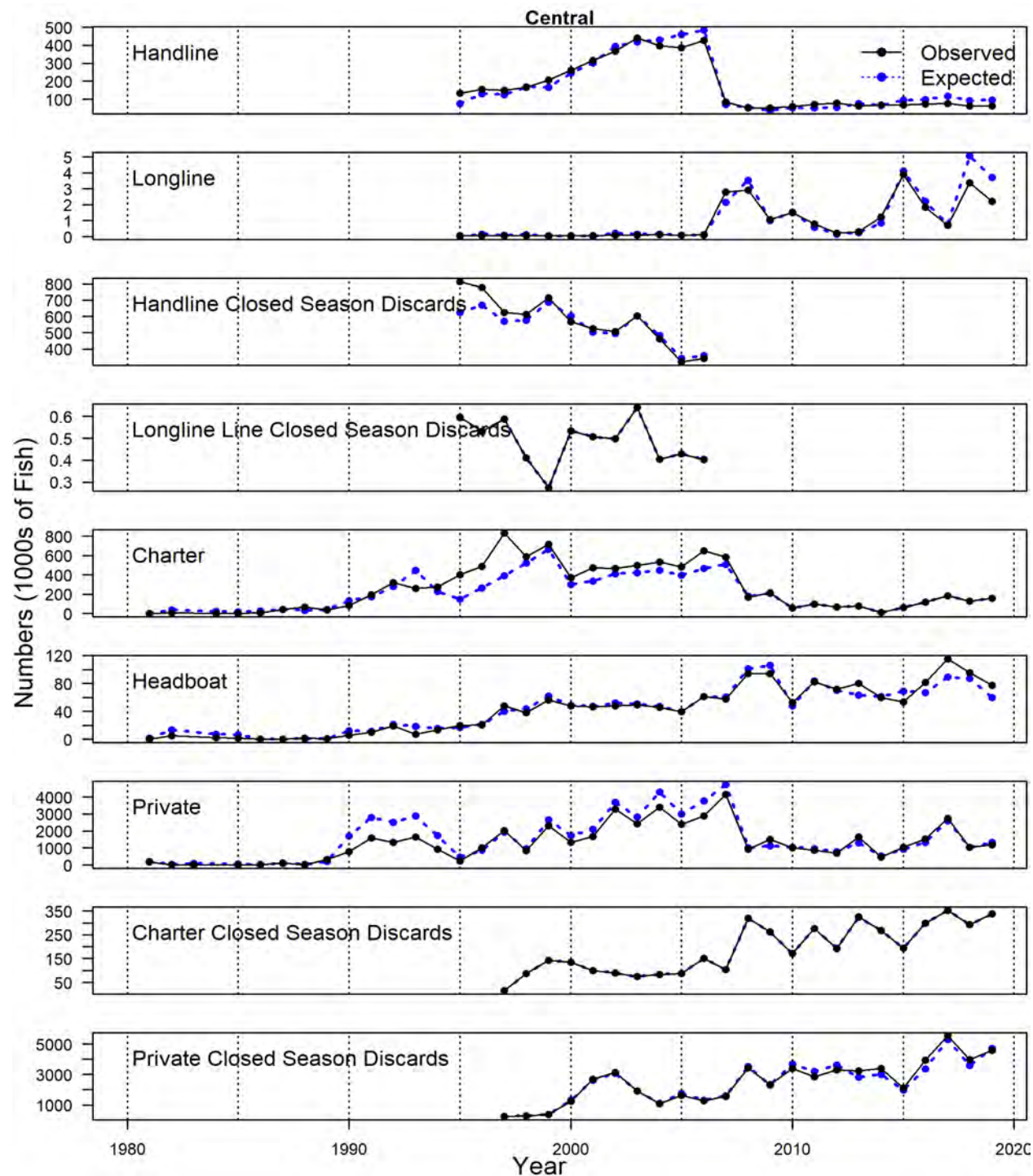


Figure 137. Central Gulf of Mexico Red Snapper observed and expected discards by fleet for SEDAR 74 (left panels). Commercial and recreational discards are in thousands of fish, respectively. Dashed vertical lines identify five year intervals.



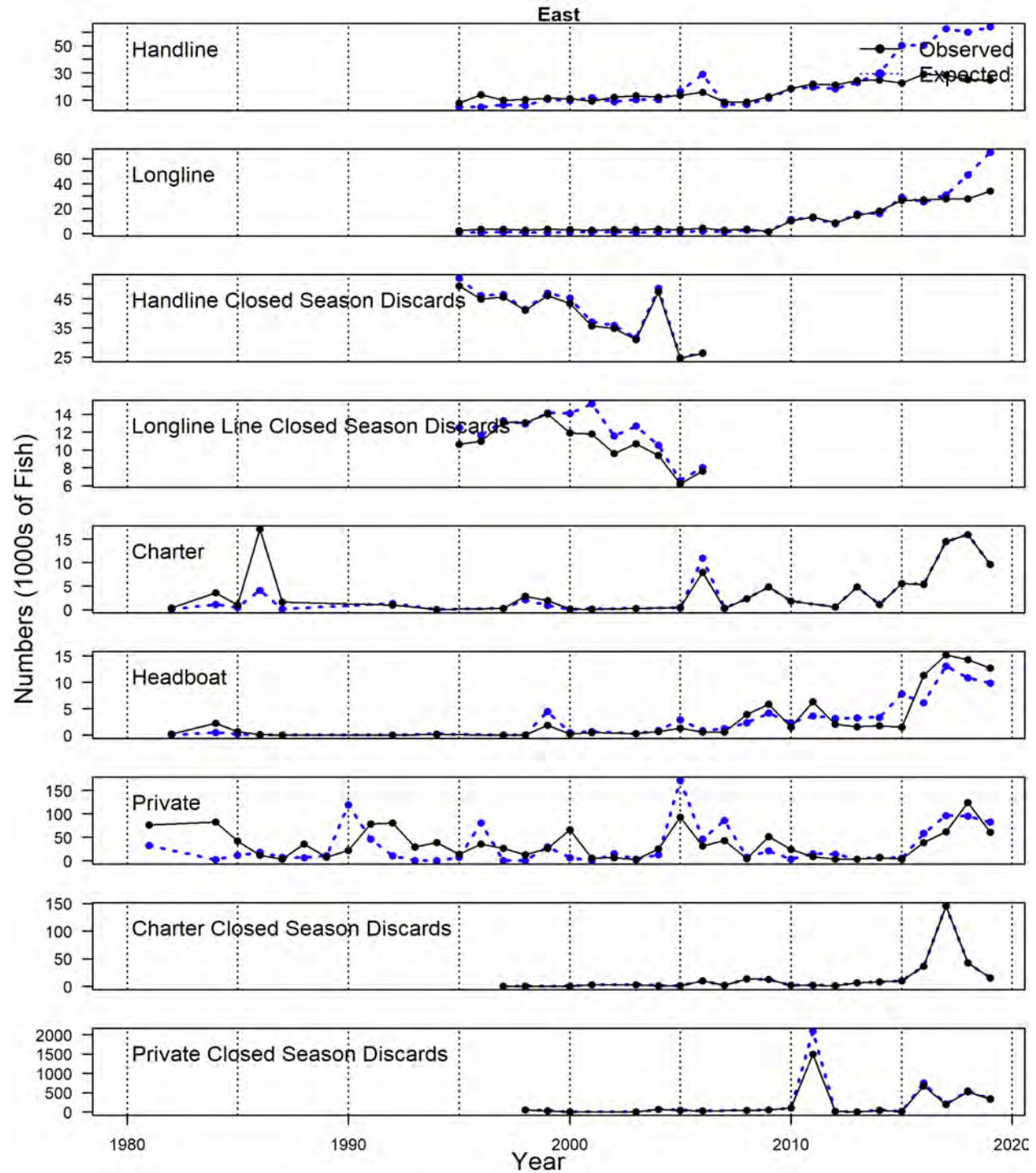


Figure 138. Eastern Gulf of Mexico Red Snapper observed and expected discards by fleet for SEDAR 74 (left panels). Commercial and recreational discards are in of fish, respectively. Dashed vertical lines identify five year intervals.

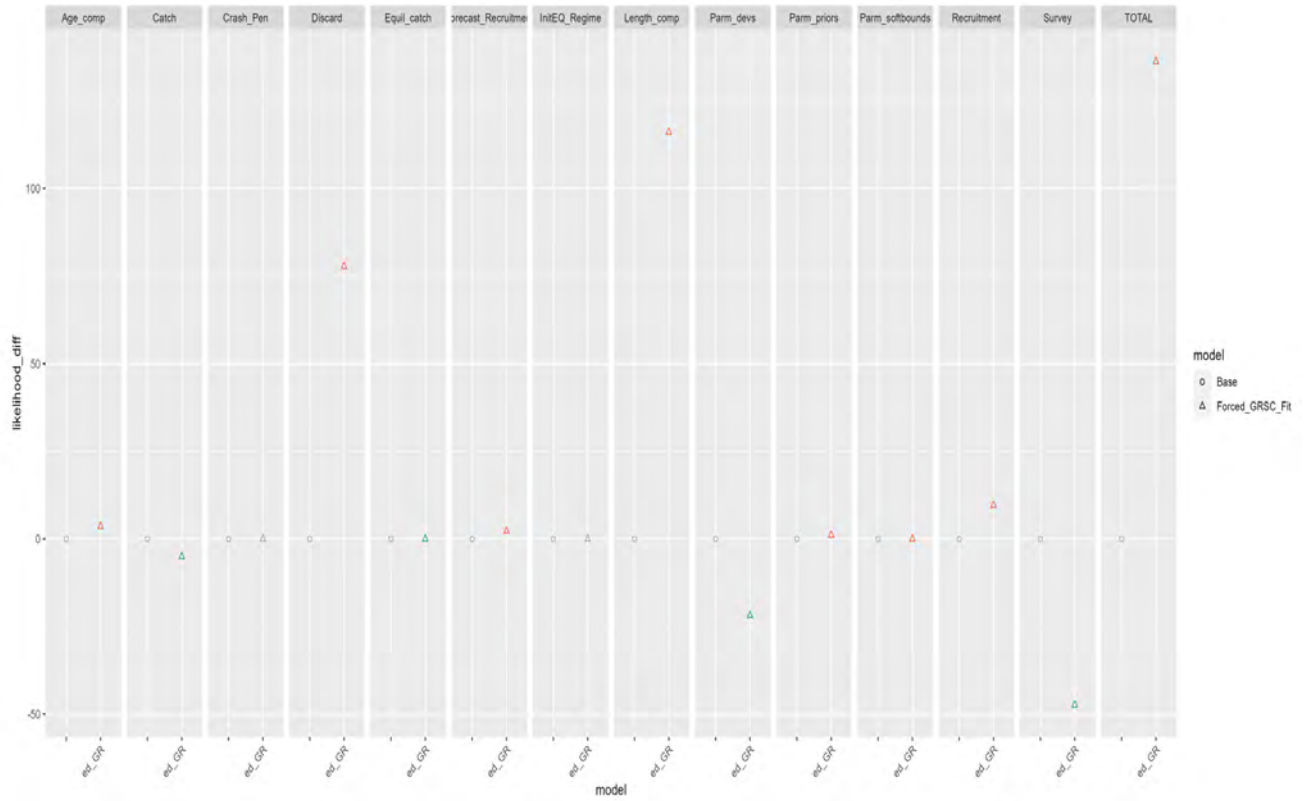


Figure 139. Likelihood component comparison of base model (circles) to a model with the Red Snapper Count data having an increased lambda (i.e., high penalty for model misfitting in the data) (triangles). Red symbols indicate decreased fit to a likelihood component, green symbol indicates and improved fit to a likelihood component.

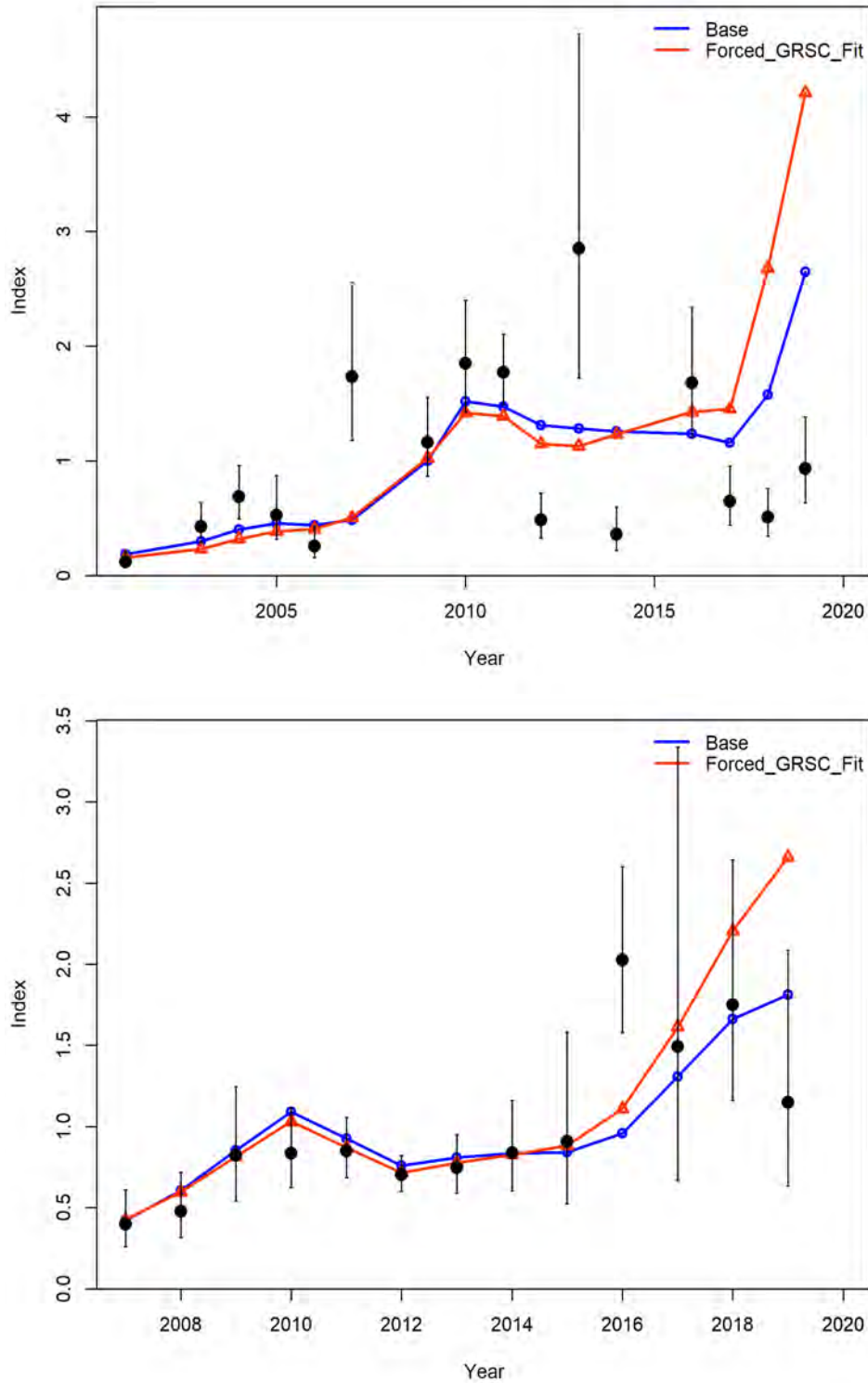


Figure 140. Comparison of fit to specific indices impacted by forced confidence in the GRSC data: Bottom Longline East (top) and Commercial Reed Fish Observer East index (bottom).



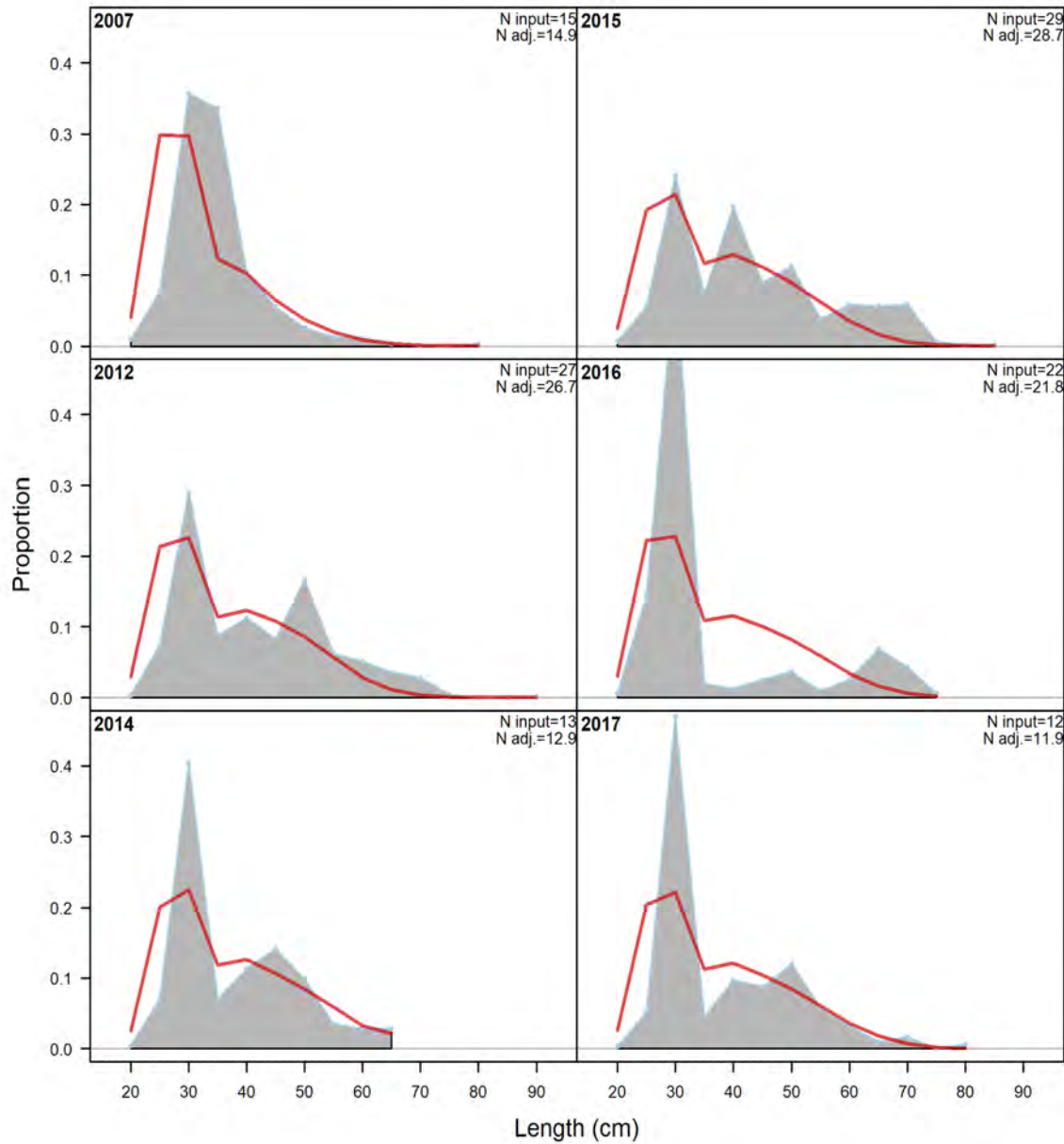


Figure 141. Length compositions, discard, Commercial Handline West. 'N input' is the input sample size. 'N adj.' is the sample size after adjustment by the Dirichlet-Multinomial  $\Theta$  parameter based on the formula  $N\ adj. = 1 / (1+\Theta) + N \Theta / (1+\Theta)$ . For this fleet,  $\Theta = 92.844$  and the sample size multiplier is approximately  $\Theta / (1+\Theta) = 0.989$ .\*

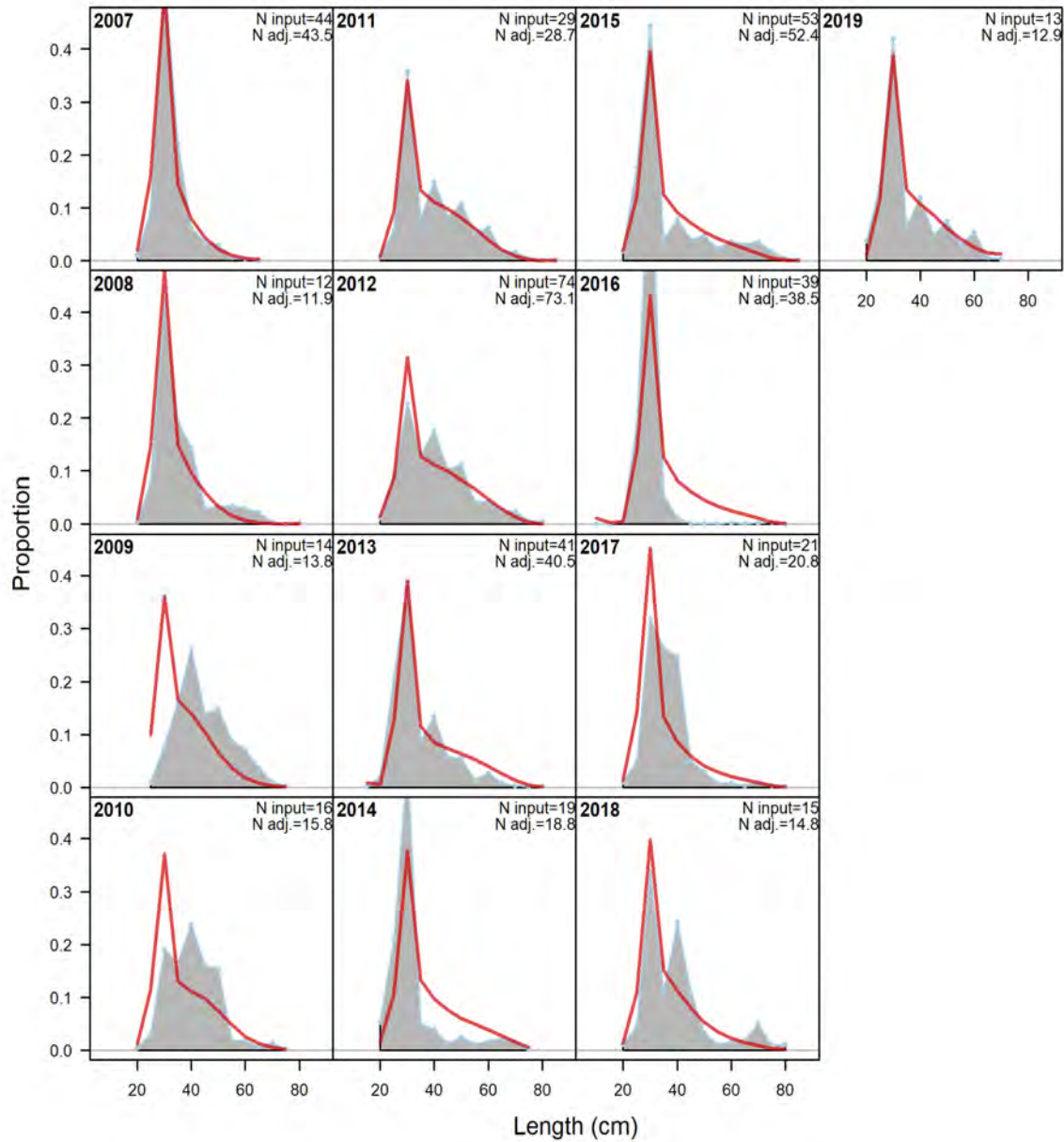


Figure 142. Length compositions, discard, Commercial Handline Central. 'N input' is the input sample size. 'N adj.' is the sample size after adjustment by the Dirichlet-Multinomial  $\Theta$  parameter based on the formula  $N\ adj. = 1 / (1+\Theta) + N \Theta / (1+\Theta)$ . For this fleet,  $\Theta = 70.442$  and the sample size multiplier is approximately  $\Theta / (1+\Theta) = 0.986$ .\*

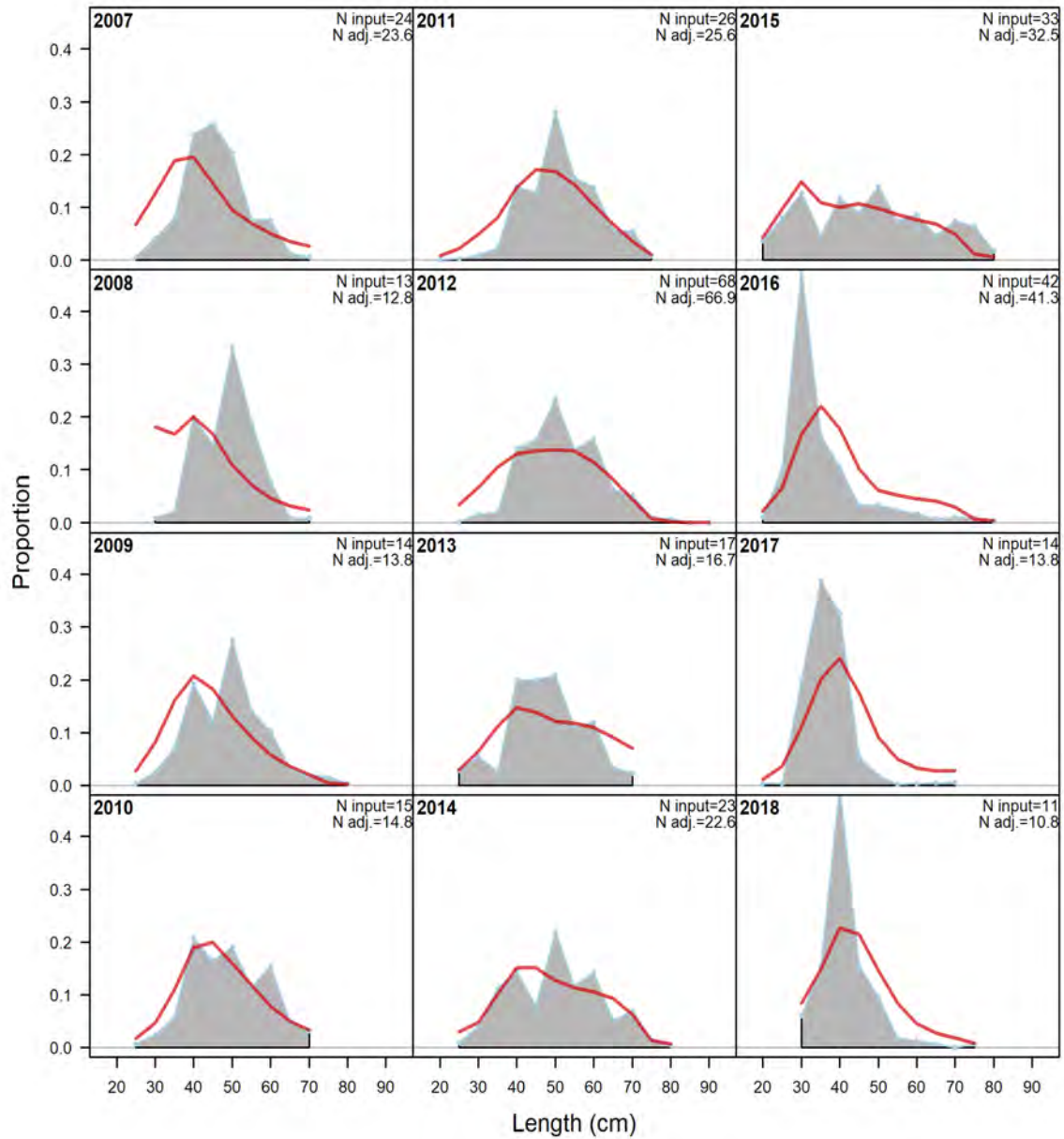


Figure 143. Length compositions, discard, Commercial Handline East. 'N input' is the input sample size. 'N adj.' is the sample size after adjustment by the Dirichlet-Multinomial  $\Theta$  parameter based on the formula  $N \text{ adj.} = 1 / (1+\Theta) + N \Theta / (1+\Theta)$ . For this fleet,  $\Theta = 56.942$  and the sample size multiplier is approximately  $\Theta / (1+\Theta) = 0.983$ .\*

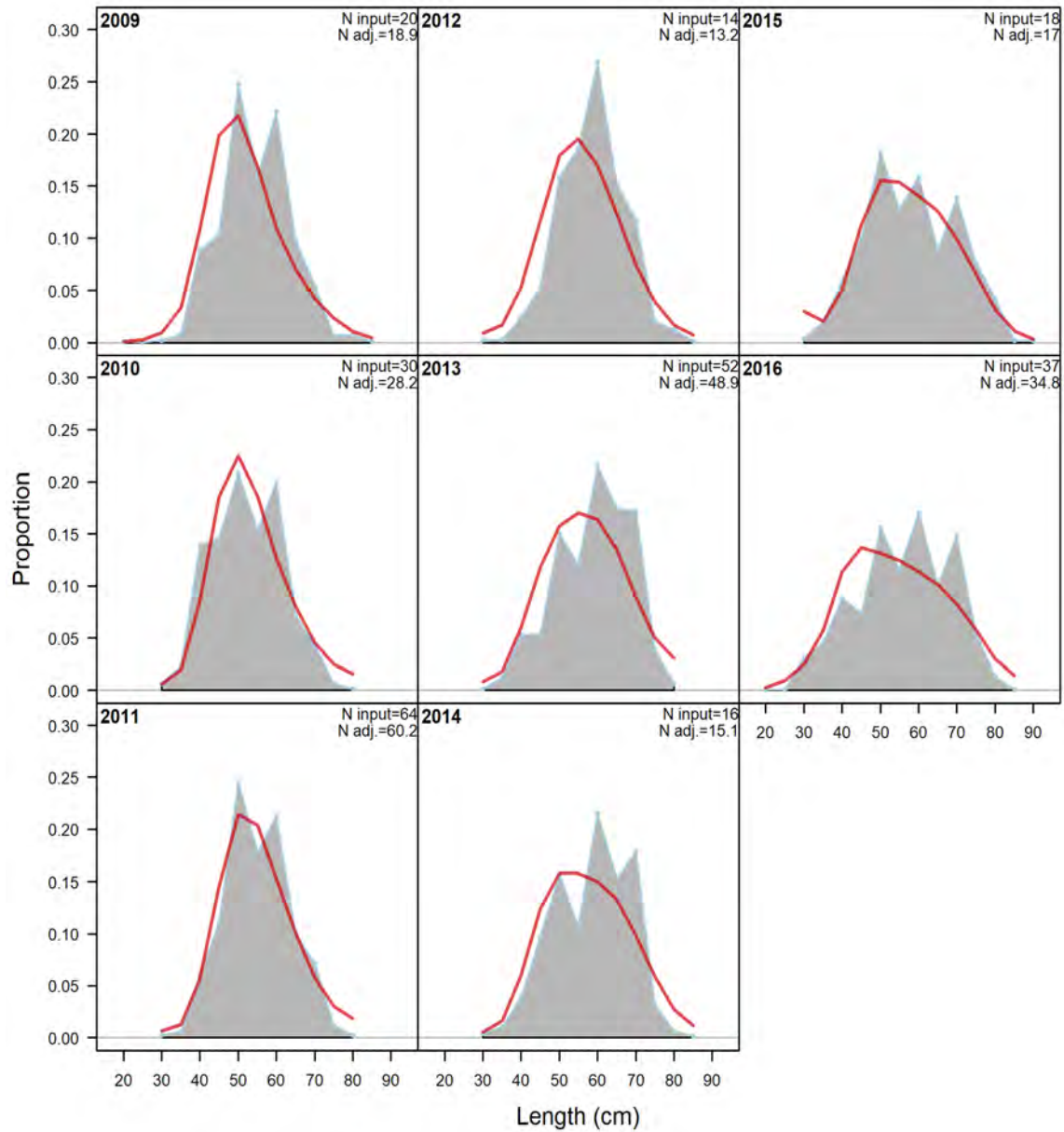


Figure 144. Length compositions, discard, Commercial Longline East. ‘N input’ is the input sample size. ‘N adj.’ is the sample size after adjustment by the Dirichlet-Multinomial  $\Theta$  parameter based on the formula  $N \text{ adj.} = 1 / (1 + \Theta) + N \Theta / (1 + \Theta)$ . For this fleet,  $\Theta = 40.876$  and the sample size multiplier is approximately  $\Theta / (1 + \Theta) = 0.976$ .\*



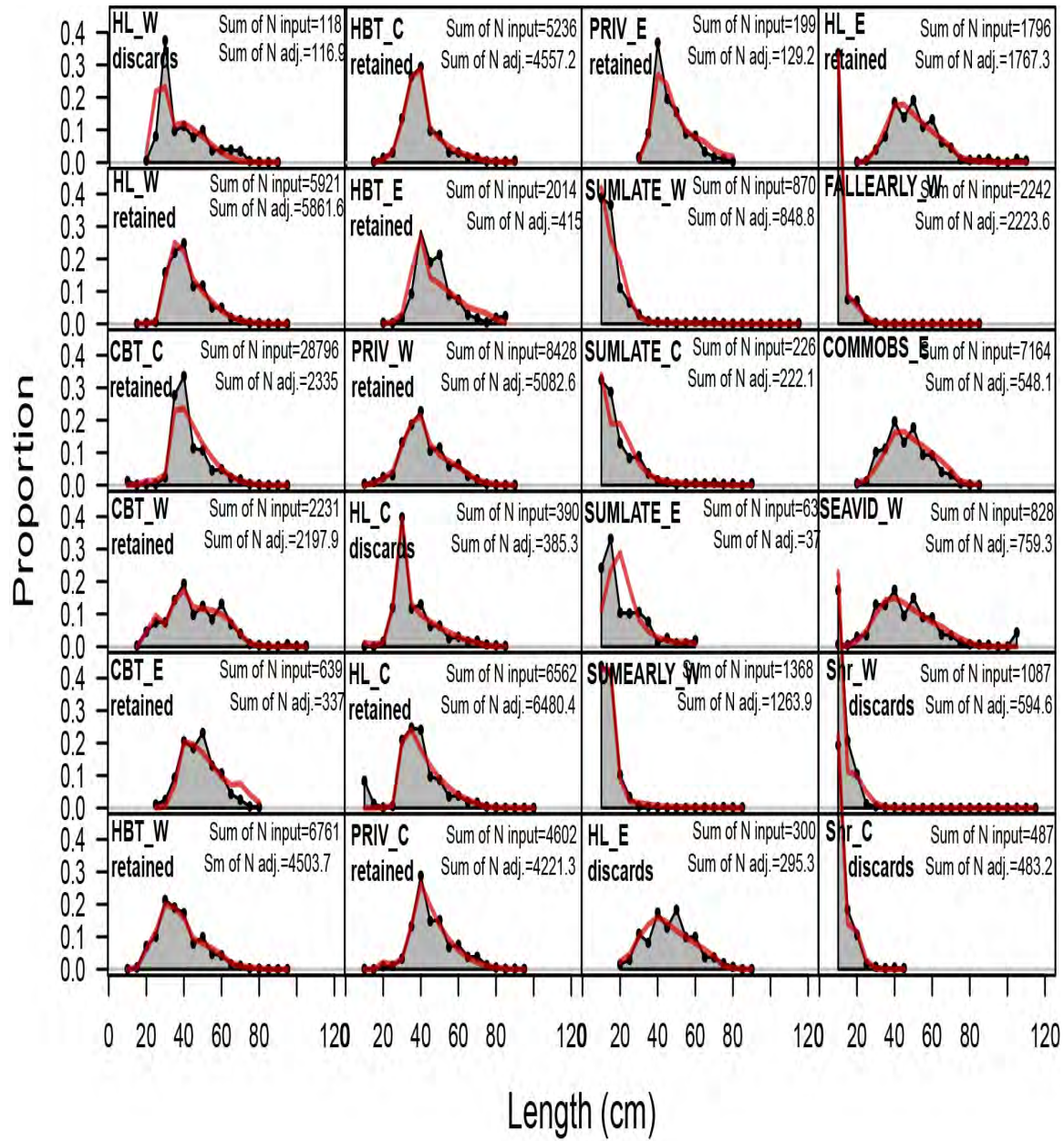


Figure 145. Length compositions, aggregated across time by fleet. Labels 'retained' and 'discard' indicate discarded or retained sampled for each fleet. Panels without this designation represent the whole catch.

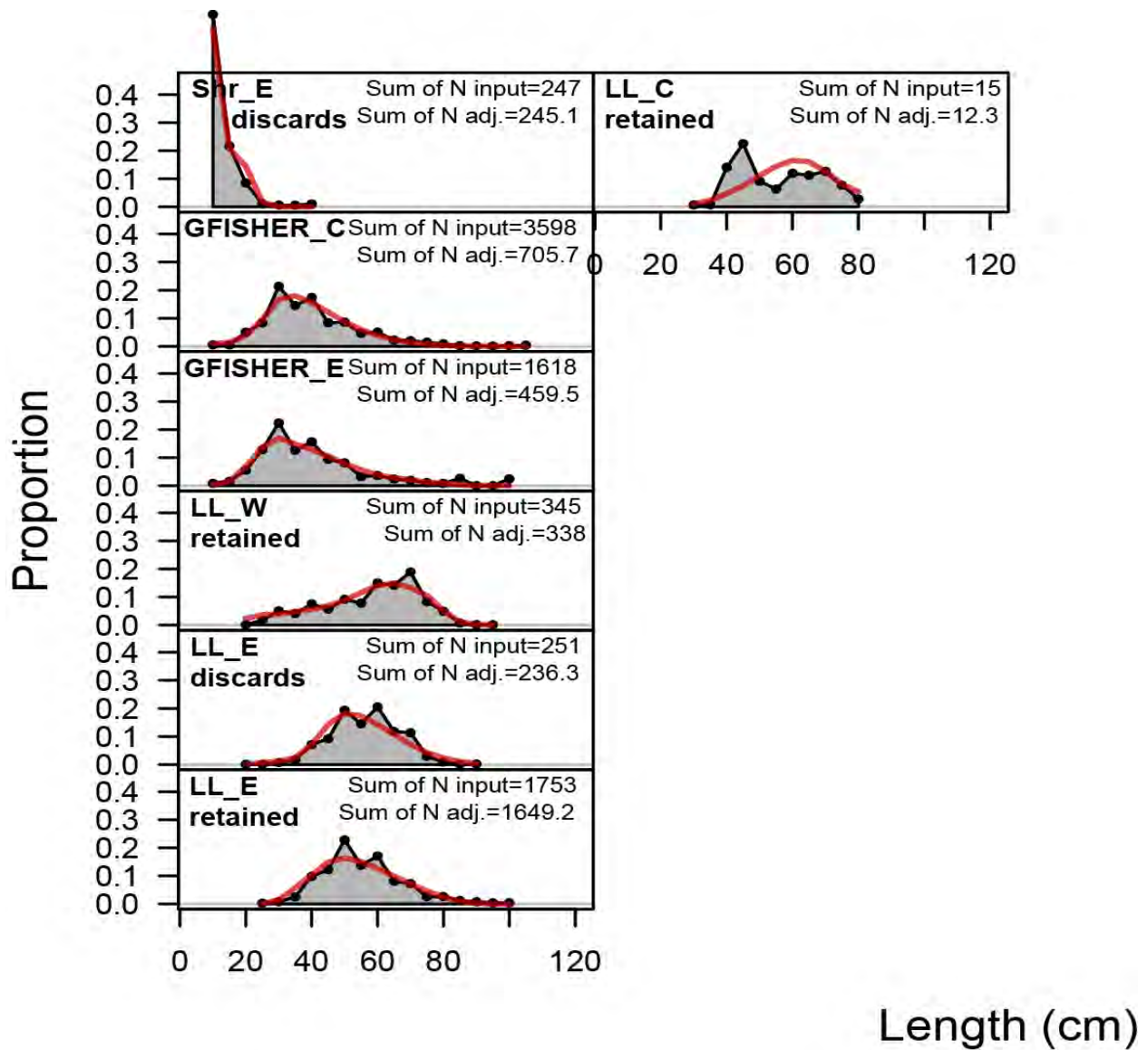


Figure 145 Continued. Length compositions, aggregated across time by fleet (plot 2 of 2).

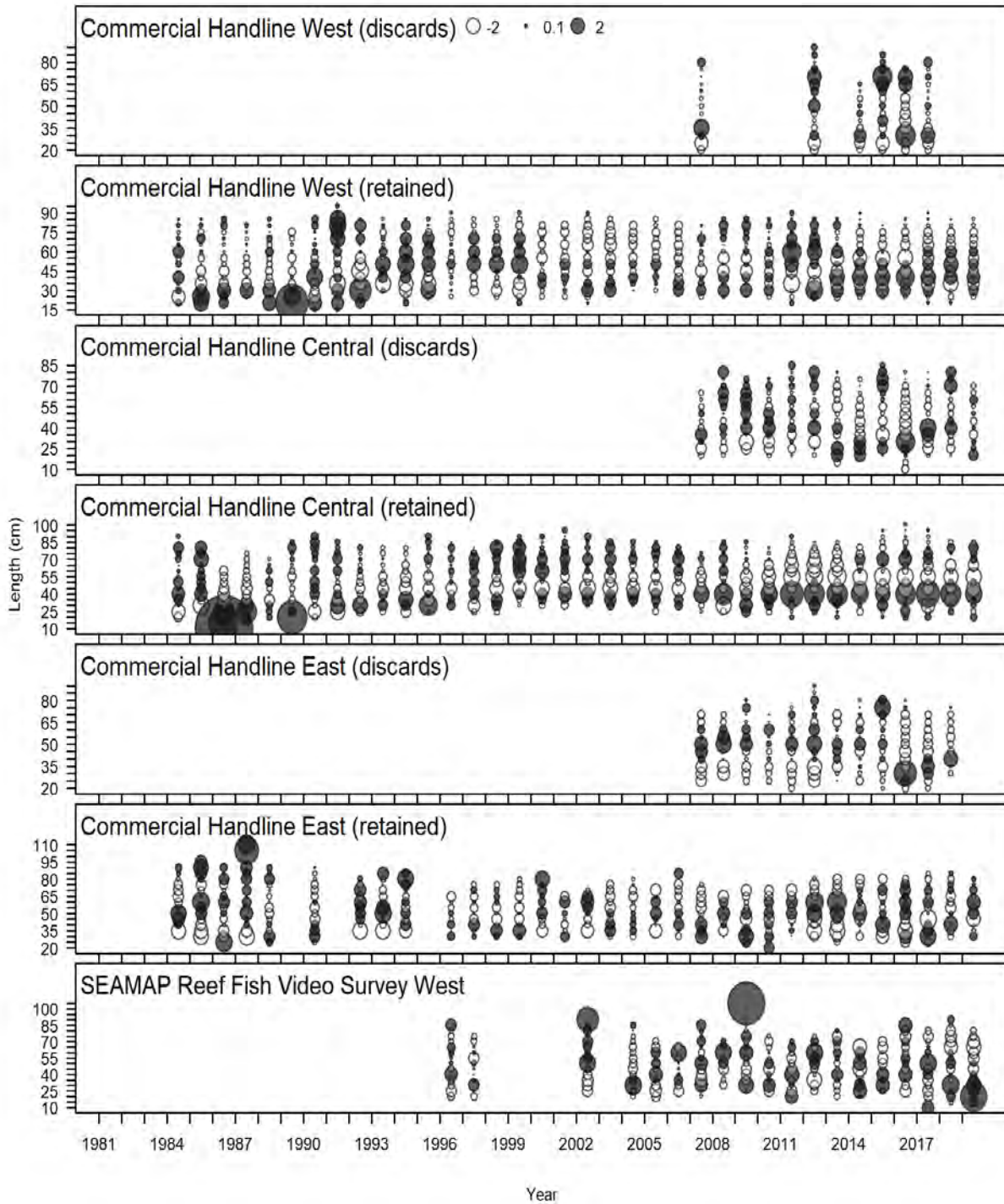


Figure 146. Pearson residuals for discard and retained length composition data by year compared across fleets and surveys for Gulf of Mexico Red Snapper for SEDAR 74. Closed bubbles are positive residuals (observed > expected) and open bubbles are negative residuals (observed < expected).



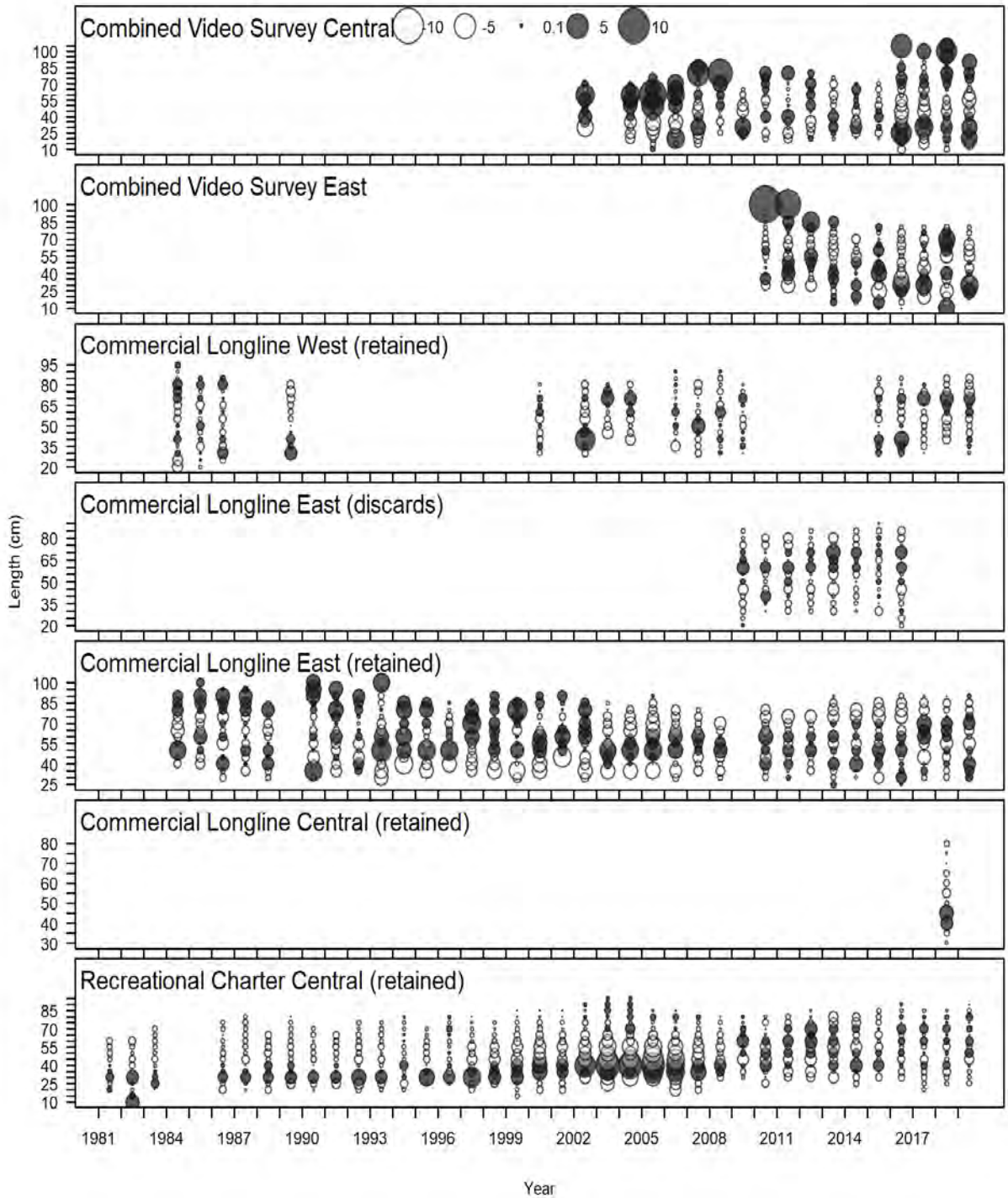


Figure 146 Continued. Pearson residuals for discard and retained length composition data by year compared across fleets and surveys for Gulf of Mexico Red Snapper for SEDAR 74. Closed bubbles are positive residuals (observed > expected) and open bubbles are negative residuals (observed < expected).



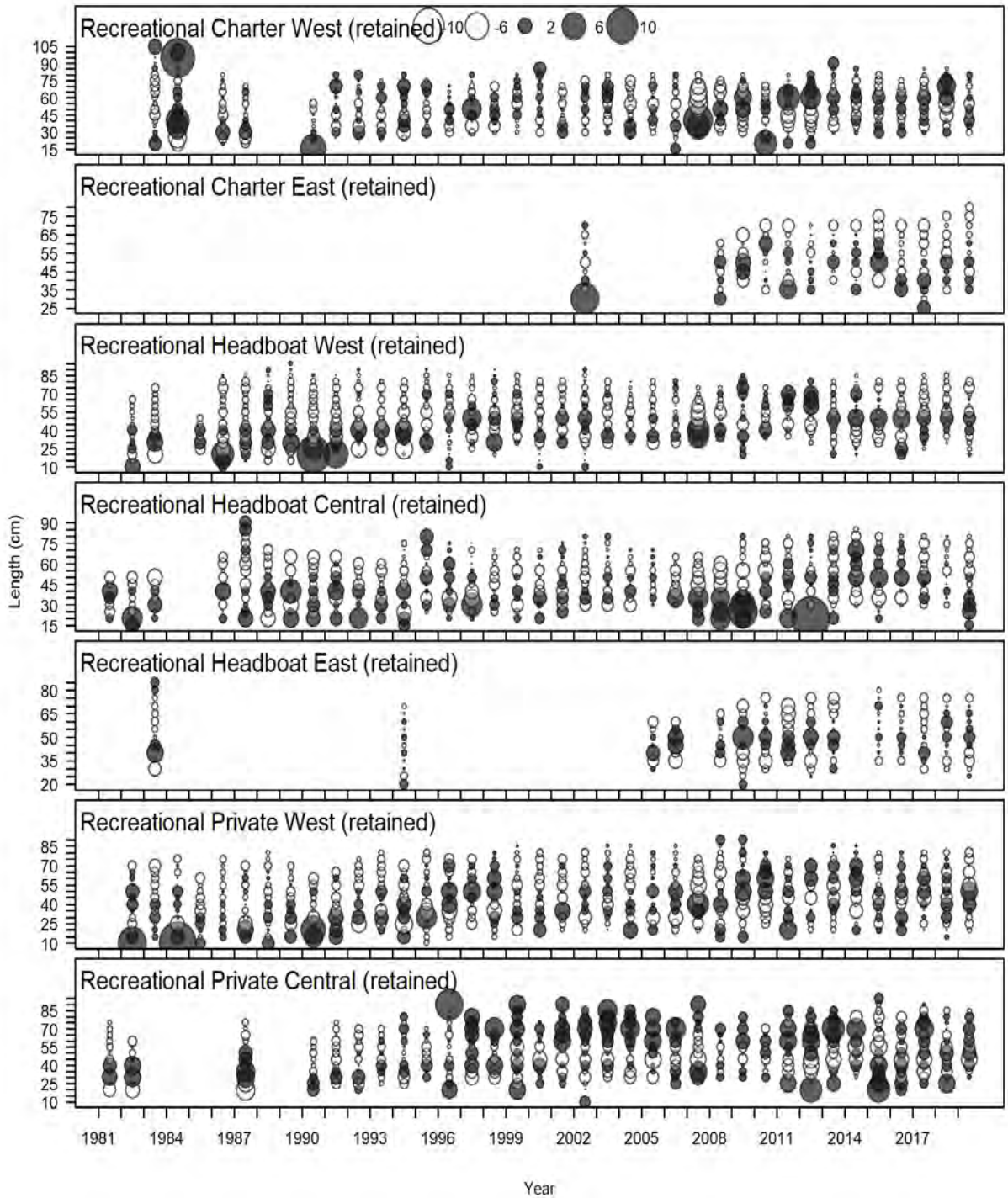


Figure 146 Continued. Pearson residuals for discard and retained length composition data by year compared across fleets and surveys for Gulf of Mexico Red Snapper for SEDAR 74. Closed bubbles are positive residuals (observed > expected) and open bubbles are negative residuals (observed < expected).

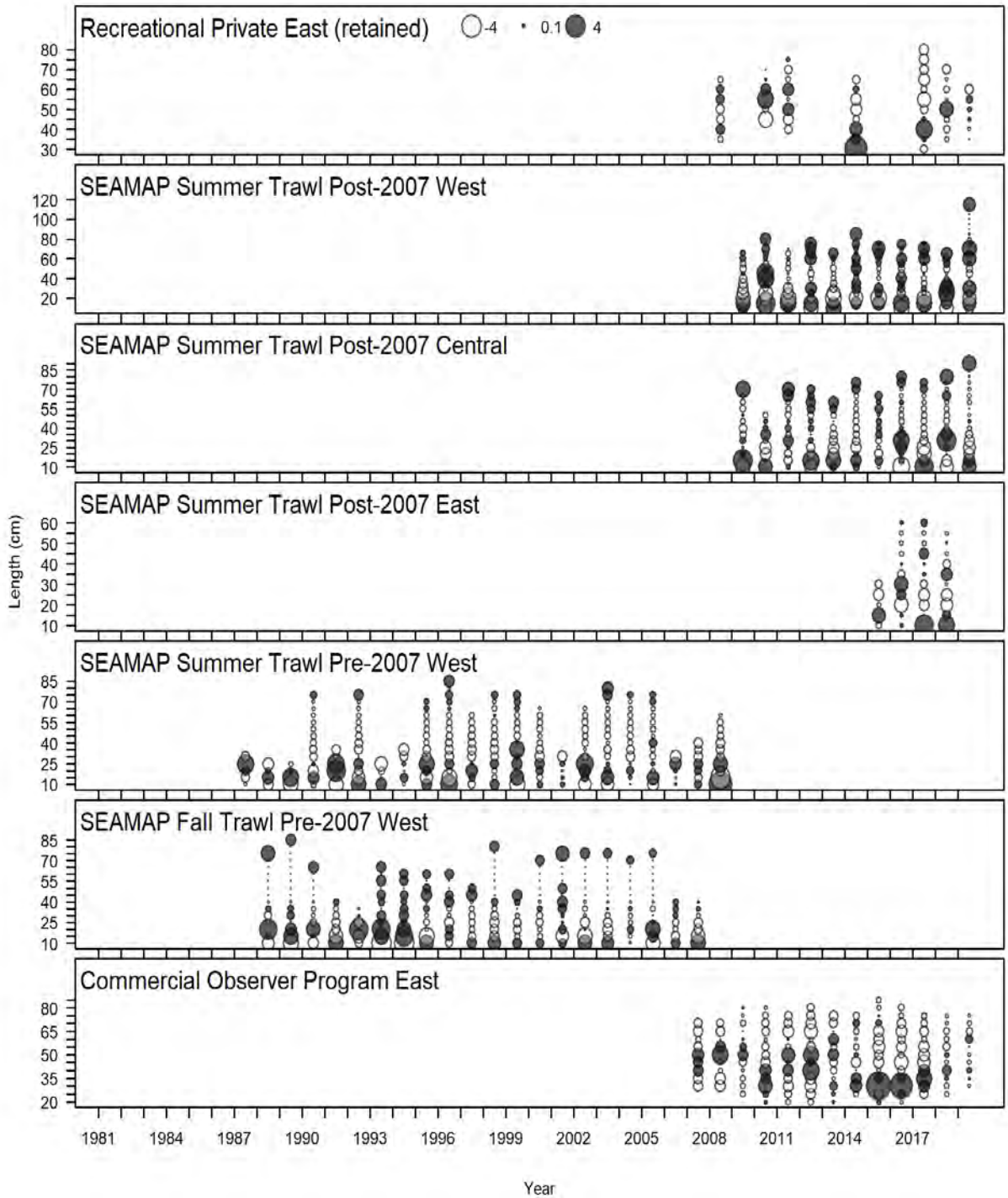


Figure 146 Continued. Pearson residuals for discard and retained length composition data by year compared across fleets and surveys for Gulf of Mexico Red Snapper for SEDAR 74. Closed bubbles are positive residuals (observed > expected) and open bubbles are negative residuals (observed < expected).

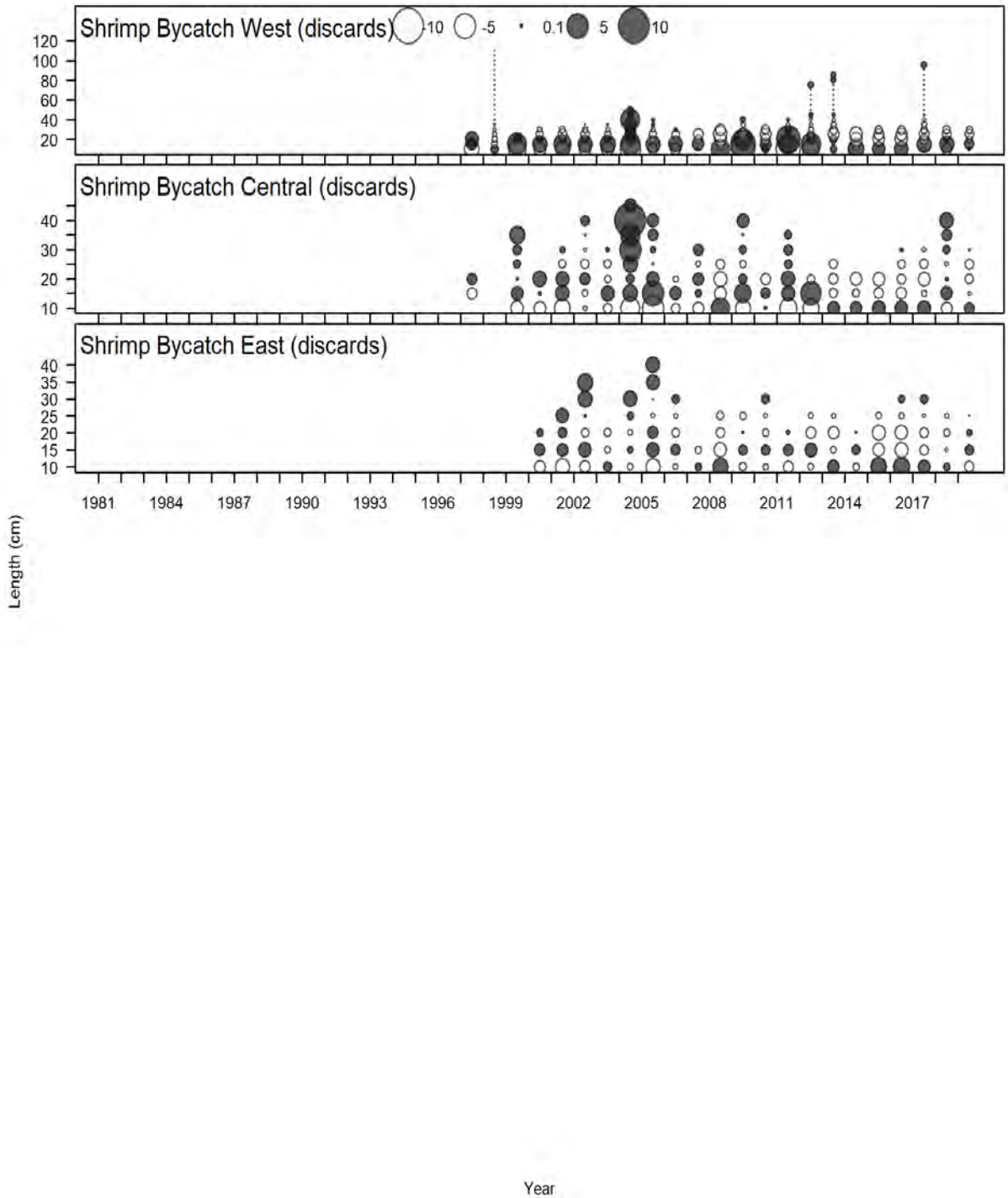


Figure 146 Continued. Pearson residuals for discard and retained length composition data by year compared across fleets and surveys for Gulf of Mexico Red Snapper for SEDAR 74. Closed bubbles are positive residuals (observed > expected) and open bubbles are negative residuals (observed < expected).

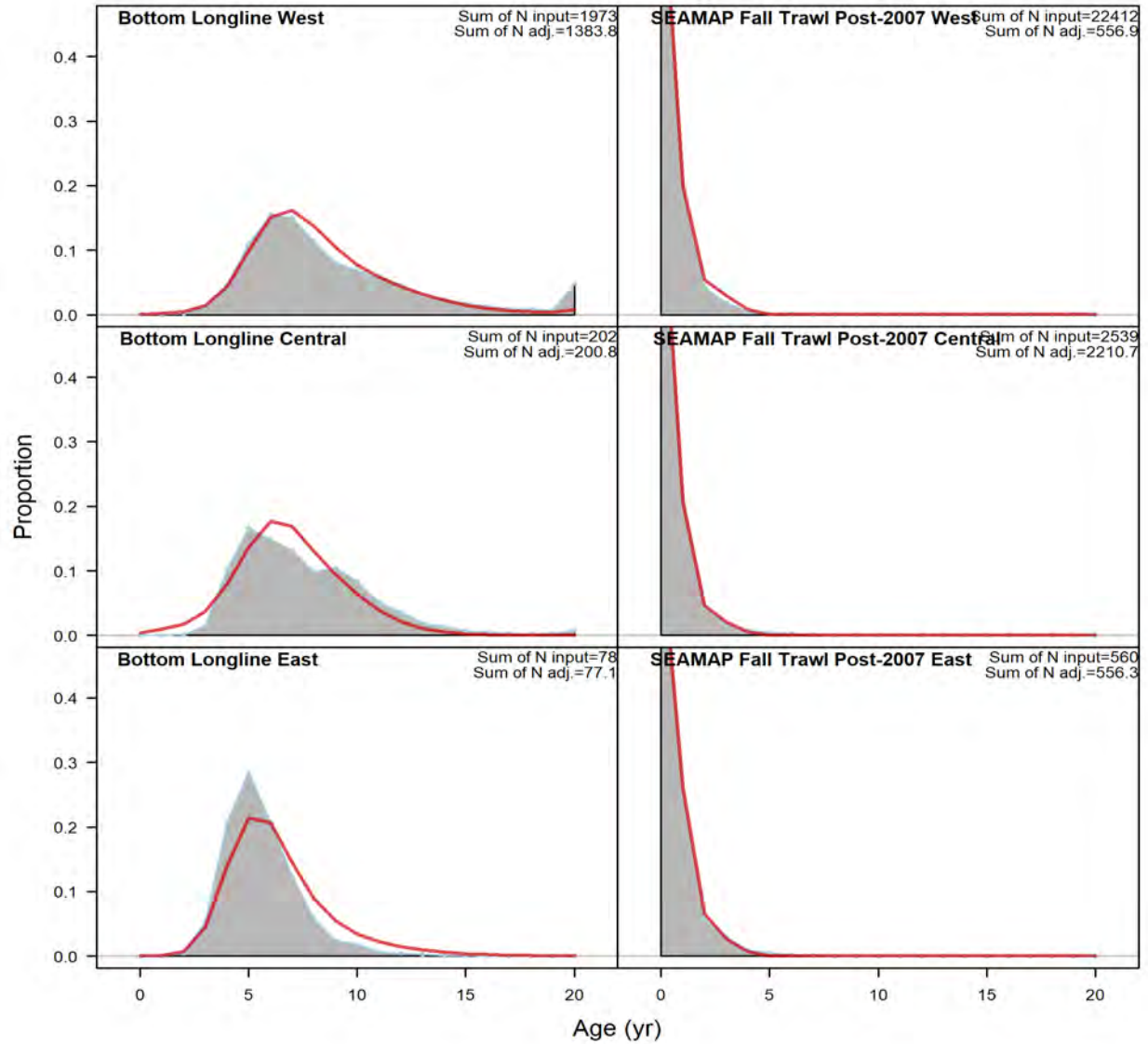


Figure 147. Age compositions, aggregated across time by fleet. Labels 'retained' and 'discard' indicate discarded or retained sampled for each fleet. Panels without this designation represent the whole catch.



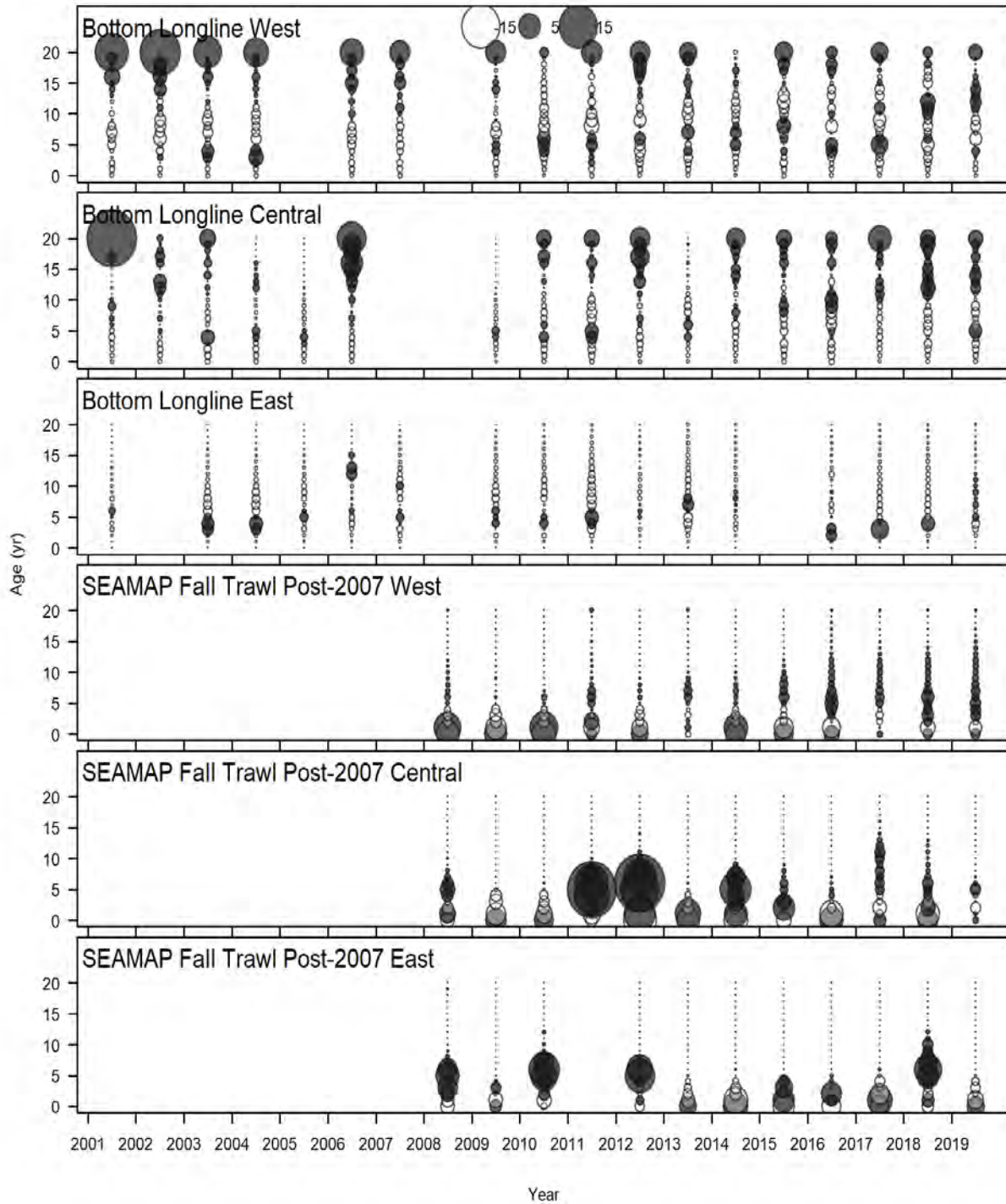


Figure 148. Pearson residuals for discard and retained length composition data by year compared across fleets and surveys for Gulf of Mexico Red Snapper for SEDAR 74. Closed bubbles are positive residuals (observed > expected) and open bubbles are negative residuals (observed < expected).

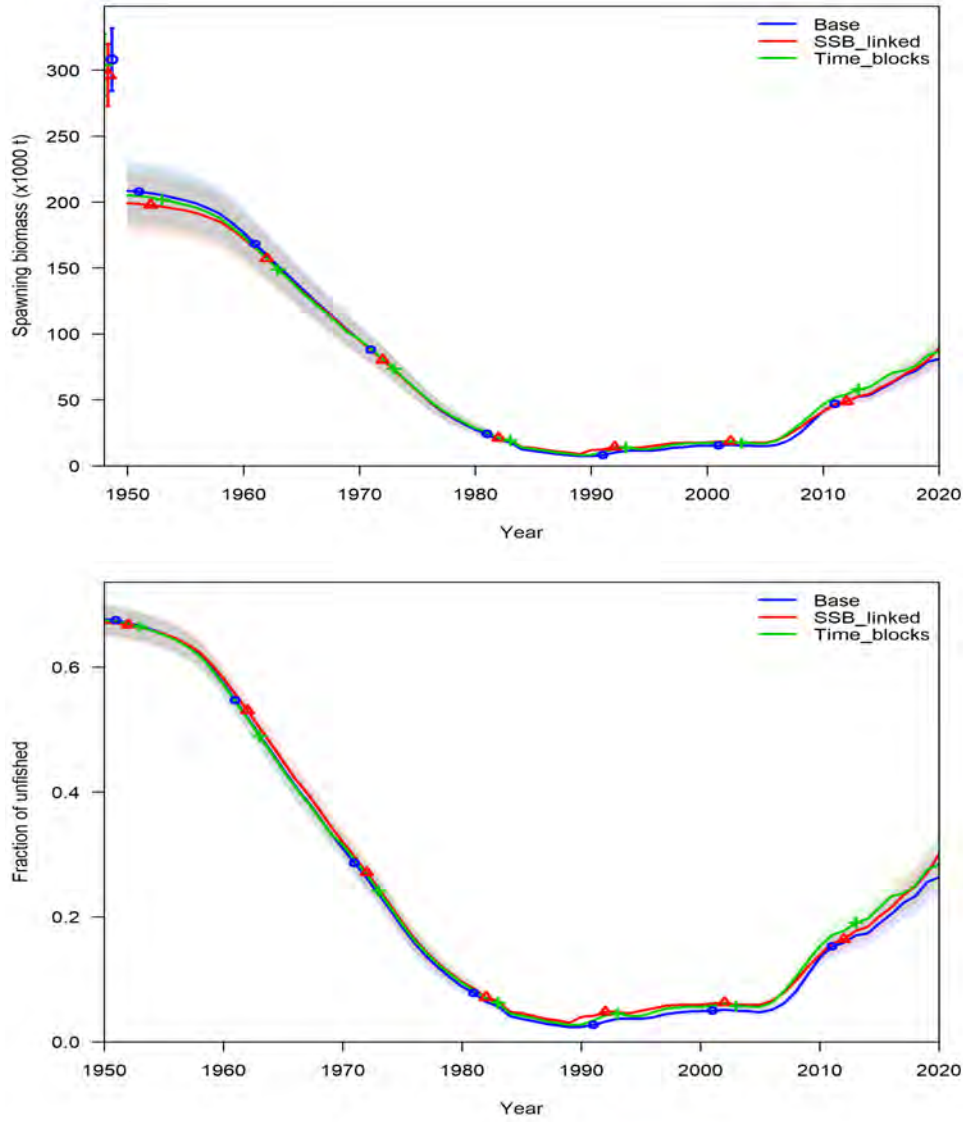


Figure 149. Differences in the time series of SSB and fraction unfished ( $SSB/SSB_0$ ) between the SEDAR 74 base model and the two Maturity sensitivity runs.

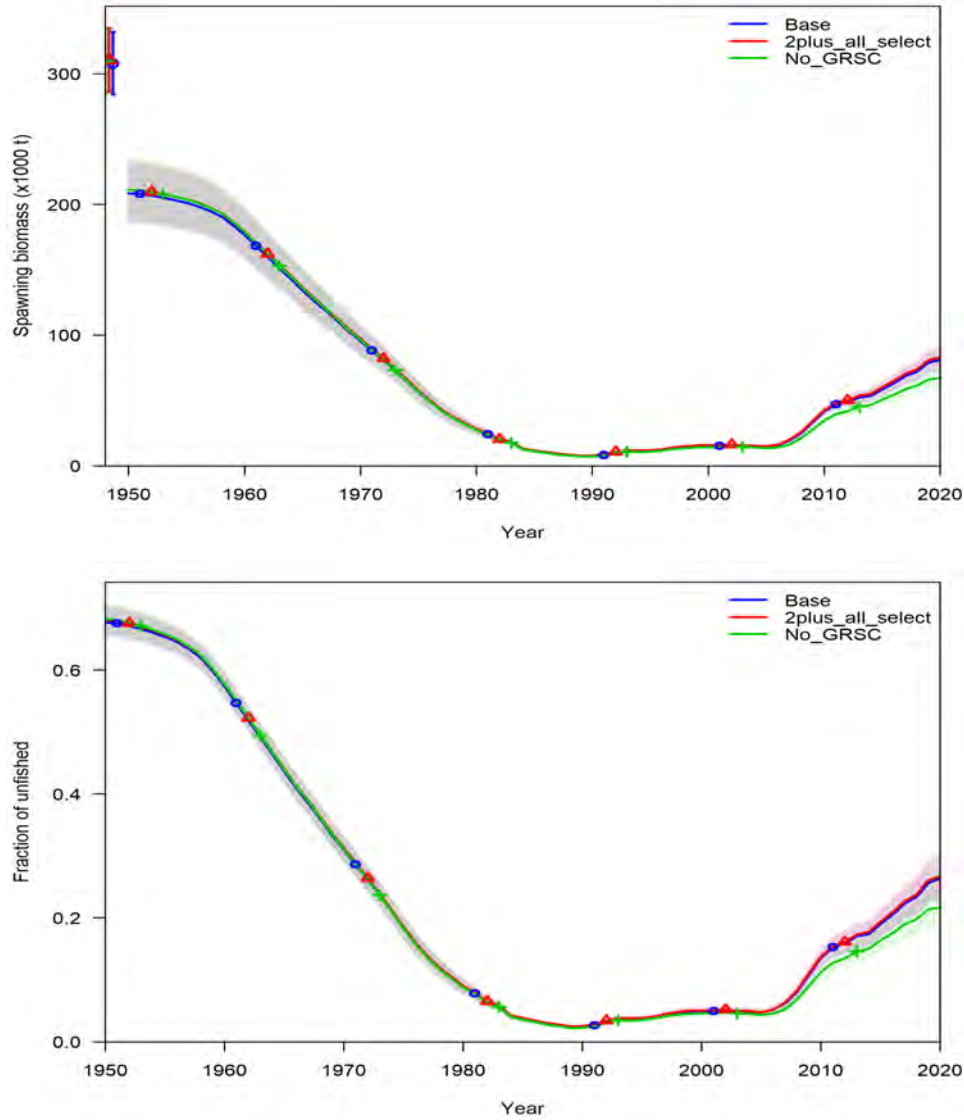


Figure 150. Differences in the time series of SSB and fraction unfished ( $SSB/SSB_0$ ) between the SEDAR 74 base model and the Red Snapper Count sensitivity runs.



SEDAR

Southeast Data, Assessment, and Review

---

SEDAR 74

Gulf of Mexico Red Snapper

SECTION V: Research Recommendations

SEDAR  
4055 Faber Place Drive, Suite 201  
North Charleston, SC 29405



Table of Contents

**1. DATA WORKSHOP RESEARCH RECOMMENDATIONS .....2**  
**1.1 LIFE HISTORY RESEARCH RECOMMENDATIONS .....2**  
**1.2 COMMERCIAL FISHERY STATISTICS RESEARCH RECOMMENDATIONS .....4**  
**1.3 RECREATIONAL FISHERY STATISTICS RESEARCH RECOMMENDATIONS .....4**  
 Evaluation and Progress of Research Recommendations from Previous Assessments .....4  
 Research Recommendations for SEDAR 74 .....6  
**1.4 MEASURES OF POPULTAION ABUNDANCE RESEARCH RECOMMENDATIONS.....7**  
**2. ASSESSMENT PROCESS RESEARCH RECOMMENDATIONS .....7**  
**3. REVIEW PANEL RESEARCH RECOMMENDATIONS .....8**

**1. DATA WORKSHOP RESEARCH RECOMMENDATIONS**

***1.1 LIFE HISTORY RESEARCH RECOMMENDATIONS***

*Age*

- Resources are needed for personnel and database infrastructure to manage large, multi-decade life history datasets that are beginning to exceed the capabilities of standard computers.
- Create a data repository with an upload interface for data providers to submit data directly into the SEDAR template. Build in standardized QA/QC methods for all data providers so that erroneous data points and outliers are identified and corrected prior to data workshops.
- Resume annual ageing workshops with gulf state agencies and other age data contributors to maintain high-quality age data given standard turnover rates among primary agers.
- Expand routine biological sampling, particularly in the eastern GOM subregion, where sample sizes are much lower compared to other subregions.
- The current subsampling protocol for red snapper is based on 5-year average landings by grid and is laborious and time consuming. Evaluate the current otolith subsampling protocol and provide alternatives to streamline the process.
- Evaluate the sampling design for observer programs.
- Investigate new technologies for estimating life history parameters (e.g. FT-NIRS, epigenetics) to increase production ageing efficiency and precision of age estimates.
- Increase sampling of sublegal fish through fishery independent surveys and the shrimp observer program to better estimate maturity and fecundity of smaller individuals, as well as samples through tournament intercepts to better estimate batch fecundity of larger/older females.

### *Growth*

- Use inverse weighted age data for fitting growth curves.
- Estimate growth separately for each subregion with data from all years combined.

### *Reproduction*

- Standardize data fields on the template, as well as limiting them to the data needed. It is especially important that data providers QA/QC their own data prior to submitting to ensure multiple fields are not used for the same parameter.
- Additional histological sampling is needed from the east region (FL west coast to Cape San Blas) to allow analyses by three regions.
- Adopt the slightly modified reproductive phase names and criteria from Lowerre-Barbieri et al. (2022).
- Adopt the standardized methodology from Lowerre-Barbieri et al. (2022) to estimate spawning season and peak spawning months.
- Maturity models should only use immature and spawning females (i.e., those with spawning markers) if sample size allows, rather than filtering data by peak spawning season, as recommended in Lowerre-Barbieri et al. (2022).
- Conduct batch fecundity estimates only on females in late oocyte maturation without POFs (histological analysis of ovaries used for batch fecundity is needed). Preserve ovaries only in formalin rather than Gilson's or freezing them. Use the washing process presented in Lowerre-Barbieri et al. (1993) for separating out the OM oocytes for fecundity estimates, which works equally well for fresh or preserved ovaries.
- Research on Red Snapper spawning marker duration, as well as selectivity of fish with spawning markers is needed to improve estimates of spawning frequency.
- Given the uncertainty in the fecundity-at-age vectors over time, utilize SSB as the measure of reproductive potential (Lowerre-Barbieri and Friess, 2022).

### *Natural Mortality*

- Use the observed maximum age of 57 years when estimating age-specific M.
- Estimate a single M value and age-specific vector for all regions.
- Use the Then et al. (2015) method to estimate M using Lutjanid-specific parameters.
- Scale Then et al. (2015) derived estimate of M to age-specific values using Lorenzen function (1996).
- While important questions remain about density dependent effects on juvenile red snapper mortality, no
- new studies of age-0 and age-1 red snapper natural mortality were identified. All of the identified existing studies were considered in previous assessments, and their results are in line with the natural mortality rates for age-0 and age-1 red snapper used in SEDAR 31

and 52. Therefore, we recommend using  $M = 2.0$  for age-0 and  $M = 1.2$  for age-1 red snapper.

- We recommend additional effort to collect age-0 and age-1 red snapper to better estimate natural mortality rates and density dependent responses.

### *Episodic Events*

- Further research is needed on the effects of episodic events on all life stages of red snapper.

## **1.2 COMMERCIAL FISHERY STATISTICS RESEARCH RECOMMENDATIONS**

- Explore estimating gear selectivity using kept and discarded size data from the reef fish observer program.
- Investigate improving biological sampling of observer program by expanding sampling of otoliths paired with length data. Sampling should be completed without affecting fishing behavior and that may be possible by having sampling occur during breaks in fishing activity.
- Consider issuing research permits to fishers to retain catch below minimum size to collect samples for age length keys.
- Observer sampling may be supplemented by buying a percentage of catch for fish that cannot be extracted without causing damage to fish.
- Investigate trip ticket data for market category compared to length compositions. This analysis may provide some signal of age classes within the data.
- Consideration of the effect that resolutions of market category on trip tickets differ among states.

## **1.3 RECREATIONAL FISHERY STATISTICS RESEARCH RECOMMENDATIONS**

### Evaluation and Progress of Research Recommendations from Previous Assessments

Research recommendations from SEDAR 31 in 2013 were evaluated and progress on each item is outlined below:

1. Evaluate the technique used to apply sample weights to landings. Investigate the SEFSC method by analyzing the order of variables in the hierarchy and the minimum number of fish used. Furthermore, evaluate alternative methods, including a meta-analysis of the existing information from different sources, areas, states, surveys, etc. that could be performed.

### ***Evaluation of Progress***

- Clarity has been requested regarding the first line of this research recommendation. The sample weights here are referring to the weight of the fish sampled in APAIS and how those are used to calculate average weights for landings estimates in pounds whole weight. They do not refer to survey design sample weights used by MRIP to estimate catch.
  - The minimum number of fish used was evaluated in 2019 and an adjusted minimum sample size of 15 fish per strata was recommended and has been used since (SEDAR 67-WP-06).
  - Additional size information from LA BIO has been incorporated into the SEFSC weight estimation method since 2021.
2. Develop methods to identify angler preference and targeted effort. Require a reef fish stamp for anglers targeting reef fish, pelagic stamp for migratory species, and deep-water complex stamp for deep-water species. The program would be similar to the federal duck stamp required of hunters and could help managers identify what anglers were fishing for.

***Evaluation of Progress***

- Florida requires private boat anglers to possess a State Reef Fish designation to legally possess a suite of reef fishes, including Red Snapper. This serves as a directory that is used to directly survey participants and estimate reef fish effort in Florida.
3. Continue and expand fishery-dependent at-sea observer surveys to collect discard information. This would help to validate self-reported headboat discard rates.

***Evaluation of Progress***

- Additional at-sea sampling programs for for-hire vessels have begun in Mississippi and Alabama and are described above in 4.6.2.1.
  - The State of Florida dedicated recurring funds starting in 2020 to support this work long-term and provide stability. Data are available upon request for NOAA Fisheries to validate headboat discard rates.
4. Track Texas commercial and recreational discards.

***Evaluation of Progress***

- No progress noted
5. Estimate variances associated with the headboat program.

***Evaluation of Progress***

- Method developed in SEDAR 68 Research Track assessment for Scamp and described in SEDAR 68-DW-31.
- Alternative method described above in section 4.3.4 and recommended for use in SEDAR 74.

6. Evaluate existing and new methods to estimate historical landings. Hind-casting of Red Snapper landings is complicated by a lack of reliable historical effort data. To get at estimating historical effort, analysts could track consumables (gas, ice, bait) to develop price indices.

***Evaluation of Progress***

- No progress noted

7. Investigate how CPUE changes over time due to technological advances and changes in fishing practices.

***Evaluation of Progress***

- Adjusted ratios to account for technological advances from 1955 to 1980. These are described above in 4.4.5.
- Expanded years used in CPUE calculation to include 1981 to 1989, a period of time when the Red Snapper fishery was generally unregulated.

**Research Recommendations for SEDAR 74**

1. SSC to add TOR to operational assessment to include topical working group to review and evaluate the results of the Gulf of Mexico transition plan to optimize the use of state and federal data.
2. Integrate TPWD into the Gulf Transition Team in order to further evaluate the proposed calibration between TPWD and MRIP units and identify alternative methods that may be implemented, including increased benchmarking (e.g. 3-year benchmark period).
3. Gulf Transition Team should investigate the drivers of high MRIP wave specific effort estimates for recreational modes during traditionally low effort waves (e.g. winter waves, particularly in MS).
4. Develop and implement methods in the western Gulf region to collect vital statistics on the size distribution of recreational discards and directly estimate the magnitude of recreational discards in Texas.
5. Investigate the need for weighting headboat discard length composition data from new data streams. Determine if data need to be weighted due to over or under sampling of any particular trip types. If so, provide total number of trips sampled by state (or headboat region) and year, dock to dock hours for each trip, fleet (charter vs headboat), and catch type (harvest vs discard).
6. Investigate methods for weighting charter discard length composition data (to account for uneven sampling of trip types), or determine if weighting by trip type is necessary for that fleet.
7. Develop methods to properly weight discard length composition data from different states relative to the proportional magnitude of discards.

8. Develop statistically valid methods to identify outlier estimates (e.g. extremely high catches) and adjust sample weights for records that have a disproportionately high influence on total catch estimates, and establish new SEDAR best practice methods.
9. Provide working paper or presentations during the data workshop group meeting documenting collection methods and caveats for new data streams being evaluated / used.
10. Develop a list of qualitative information about the snapper-grouper fishery from stakeholders and methods to evaluate validity.
11. Research of additional reference points for historical landings.
12. Estimate and publish historical landings for major species (or species groups) in a single initiative to ensure a consistent methodology.
13. General evaluation of start year of existing models and value of historical data.
14. Evaluate how changes in fishing outcomes (fish for freezer vs. offshore experience with a few filets for dinner) have impacted fishing behavior over time. Important for determining validity of some historical landings assumptions.

#### ***1.4 MEASURES OF POPULATION ABUNDANCE RESEARCH RECOMMENDATIONS***

- Explore alternative methods for properly weighting the DISL BLL survey in order to incorporate it with the NOAA Fisheries BLL survey
- Explore utility of design based index estimator for Gulfwide video survey
- Calibration of optical and acoustic imaging systems to better sample low visibility environments
- Explore alternative trip selection protocols that can account for changing regulations and angler behavior
- Explore influence of interacting species on gear selectivity and catchability

## **2. ASSESSMENT PROCESS RESEARCH RECOMMENDATIONS**

Recommendations for considerations of future research are provided below in no particular order of priority.

### **Recreational Landings and Discards data**

- Further develop best practices for correcting for prominent peaks and troughs in the earlier part of the time series where uncertainty is high and catch/discard estimates are driven by few but influential intercept records.
- Investigate influence of depredation as a contributor to discard mortality and its significance on observed discard data used in the assessment.

### **Composition Data Alternatives**

- Incorporating age composition and length composition data for the directed fleets and estimating growth internally to the model to facilitate fit of multiple simultaneous sources of composition data.
- Consider the application of conditional age-at-length data for use in red snapper stock assessment.

### **Alternate Start Years**

- SEDAR 74 moved the model start year from 1872 to 1950, but other later years would have been considered if not for modeling limitations. The determining factor in selecting 1950 was the shrimp bycatch data and the lack of an ability to specify an initial  $F$  for a bycatch only fleet. This issue should be further explored and possible modifications to SS should be considered to allow the consideration of later start years.

### **Additional Data Needs**

- Currently the model includes length-converted age composition data for surveys, where possible. It would benefit the model to include real age composition for trawl surveys in the future.
- Incorporating recreational discard composition into the east assessment area.
- Investigate the impact of using state survey derived landing statistics on the assessment model.

## **3. REVIEW PANEL RESEARCH RECOMMENDATIONS**

### **Provide and Comment on Recommendations to Improve the Assessment**

#### ***Consider Data and Assessment Processes Research Recommendations, Improvement to the Assessment, and Additional Longer Term Research Recommendations***

The Review Panel developed a number of conclusions about the assessment, and made recommendations about how some of the issues identified in the conclusions could be addressed. This section of the report shares our recommendations for data and model improvement in light of the conclusions reached about the assessment. The analysts followed the recommendations from the data and assessment meeting as discussed in the assessment report. Some examples of these included stock identification group three stock area model spatial partition, fixing natural mortality for age-0 and age-1 fish at values used during the last assessment, and trialing alternate start years for the model. Please note, however, that some of the recommendations in the stock assessment report are counter to the recommendations made by the Review Panel.

#### ***Recommendations for improvement or addressing inadequacies identified in the data or modeling***

As discussed in the data section above, some of the data for model development were not adequately prepared for inclusion into the assessment model. The age and length composition data included in the model were raw and unscaled to the total landings or the distribution of the fleet or survey from which they were collected. The review panel recommended that composition data be properly scaled, as is often done in other SEDAR assessments in the Gulf of Mexico so that the model could be properly evaluated. For example, in a stratified random design, length samples from a fishery would need to be scaled up to the number of fish landed in each stratum to ensure that the length frequency is representative of the total landings from the fishery.

Both age and length data were included in the SEDAR 74 model. Generally speaking, age frequency data provides more information than an associated length frequency. Given that Stock Synthesis is an age-based assessment model, it is preferable to include age frequency data whenever possible. Given that the analysts reported that they had regional, annual, age-length keys generated using data from otolith analyses, we recommend that length frequency data be scaled, converted to age frequency data, and combined with any available scaled age data by year and fleet for inclusion in the model. When age frequency data cannot be included in the model, then we recommend using length frequency if that is the only composition data available.

The configuration of the SEDAR 74 model that was presented to the reviewers was very different from the configuration used in the prior red snapper assessment. This was to be expected especially given the nature of a research track assessment, which is meant to explore alternative ways of configuring the assessment model and parsing the data. However, regarding the process, we recommend that continuity runs and bridging analyses be incorporated into the process. In this context, we are referring to continuity runs as those where the previous version of the model is updated with new data and run. Bridging is defined as making one change to the old model at a time and rerunning the model after each successive update, as an iterative methodology for arriving at a newly configured model while documenting each change made and its effect on the model. Another important recommendation regarding the research track process is that the calculation and presentation of standard diagnostics should be required to allow analysts, reviewers, and other stakeholders to best evaluate the model.

Age-structured models fitting relative biomass indices rely on the catch to be assumed to be known accurately to estimate population biomass. This assessment specified high coefficients of variation (CVs) on the removals to capture uncertainty in the landings. Although specifying this uncertainty is important, models like Stock Synthesis are designed to assume that the landings are known and with fairly high precision. Specifying high CVs on the removals provides flexibility to the model and causes Stock Synthesis to not fit the landings precisely, which can undermine the basis of these types of models. To handle uncertainty in the removals, we recommend developing several different sensitivity analysis scenarios (potentially a high, medium and low catch scenario) to test how different catch quantities could vary the model results. For each sensitivity analysis, maintain low CVs for the catch time series (see Francis



2017: Revisiting data weighting in fisheries stock assessment models, *Fisheries Research*, 192: 5-15).

All of the abundance indices were provided the same mean CV when they were input into Stock Synthesis. Assigning all indices to have the same CV does not consider the actual uncertainty behind each estimated annual index value and also informs Stock Synthesis that all indices are equally precise, which is not true. We recommend initially applying the CV from each annual estimate of the index, then applying a reweighting procedure to the indices to ensure the input variance assumptions are consistent with the output variance results. In addition, consider removing fishery dependent catch per unit effort indices given the number and quality of fishery independent indices available for this species. Incorporating fishery dependent indices could be a sensitivity analysis. It is important to acknowledge that for many species assessed in the Gulf of Mexico, we do not have enough or adequate fishery independent indices, and thus need to rely on including fishery dependent indices into these stock assessments. However, for red snapper, there are a number of fishery independent indices available that probably represent a more reliable index of abundance than fishery-dependent data sources.

The review panel found the stock assessment model to be overly complex, and discussed recommendations for how the model could be simplified. One of the ways we thought the model could be simplified was by incorporating the discarded catch either directly into the landings or as its own fleet, instead of having the model try to fit to the discards. This would reduce the number of parameters that need to be estimated by eliminating retention functions for each time block associated with each fleet with discards. To accomplish this, external to Stock Synthesis, if needed, we recommend applying the discard mortality rate to determine the total number of dead discards. Given that there is uncertainty and potential bias in discarded catch, several different scenarios developed using the CVs of the discards (perhaps a low, medium and high scenario) could be sensitivity tested. If the dead discards are combined with landings to make up total removals prior to input into SS3, combine the discard length frequency data with the length frequency data from the landed catch; properly scale the discard composition data and the composition data from the landed catch. If incorporating discards as a fleet, then pair properly scaled discard composition data with the discard fleet.

Another way that the review panel thought the complexity of the model could be simplified was to reconsider the spatial structure of the model. The review panel recognizes that Gulf of Mexico red snapper are one stock from a biological, assessment, and management perspective. The stock identification group identified three potential sub-populations and recommended a three-area spatial structure be applied to the stock assessment model. There may be compelling reasons to model the stock in multiple areas, such as when there are differences in biology or population genetics, or differences in fisher behavior or fleet structure. The review panel acknowledges that there are some differences in fishing behavior and species targeting that differentiate the West Florida Shelf from the Panhandle of Florida and waters west of the Mississippi River.

The review panel recognizes that an important part of the SEDAR process is the development of consensus decisions by the stakeholders involved regarding the analysis and incorporation of data streams into the assessment, and the structure of the assessment model. This is a very useful way to ensure that important components of the system are captured in the data analysis and the assessment. However, the assessment scientists are those who are most knowledgeable about the implications of such decisions on the outcome of the Stock Synthesis model. As such, we recommend that the final decision on model spatial structure be made by the assessment analysts, given the information provided by the stakeholders together with their knowledge of available data, their respective sample sizes in each area, and fishing behavior. In this assessment, there were a limited number of data samples in the central region. As such, despite possible differences in fisher behavior between that region and the West Florida Shelf, the review panel recommended that the eastern and central region not be modeled separately.

In addition, the review panel found that the spatial delineation between the central region and the West Florida Shelf incorporated too much of the directed grouper fishing grounds into the central region such that the boundary would need to be reconsidered if a three-area model were to be pursued. Ultimately, the review panel recommended returning to a two-area model configuration. As the red snapper stock continues to rebuild, especially in areas east of the Mississippi River, more data on red snapper catch and composition will be available potentially making it possible to support a three-area model in the future. The review panel also recommended that a three area model could be developed as a sensitivity analysis. However, the review panel also recognizes that requesting multiple spatial partitions places an additional workload on the data preparation team in the SEFSC and may not be feasible given current work assignments, until such processes are more automated.

Data from the GRSC were included in the stock assessment model as a one-year index of absolute abundance, by assigning it a catchability coefficient of 1 in the abundance index section of Stock Synthesis. After reviewing the Great Red Snapper Count documentation, the review panel (with the abstention of Dr. Sean Powers, one of the study PIs) determined that there were potential biases that had not been quantified and needed to be considered prior to including this information into the stock assessment. As discussed in an earlier section of this report, there is potential bias in the estimates of absolute abundance. As described, the average density estimated from the ROV sampling was nine times higher than the density estimated from acoustics at the same sampling stations. Due to differences like these, it is unlikely that the catchability ( $q$ ) is equal to 1.

The review panel recognizes the GRSC data as a valuable source of information, regardless of whether it is used directly in the stock assessment. To consider including this data directly into the stock assessment model, the review panel recommends that the biases for the methods used in the GRSC be quantified and used to develop informed priors for the catchability of each sampling method, and an overall catchability prior for the survey as a whole. The review panel recommends that the calculated catchability prior then be used in the Stock Synthesis model to

inform the estimation of catchability ( $q$ ) for the GRSC estimates. This will allow the GRSC estimates to be most appropriately included in the Stock Synthesis model. In addition, assuming the selectivity for the survey is uniform across ages two and older is not appropriate. The review panel recommends incorporating the associated GRSC length frequency data into the assessment (after properly scaling the data), which could then help inform an associated estimated selectivity function.

The review panel agreed that fixing the steepness ( $h$ ) of the stock-recruitment relationship at 0.99 does not properly reflect the life history characteristics of this species; doing so essentially generates the same average recruitment regardless of almost any stock size. Under this model configuration, the recruitment deviations were the only influence varying recruitment levels from one year to the next. If steepness cannot be estimated, or when allowed to be estimated, produces estimates at or close 0.99, then the review panel recommends developing several sensitivity analyses that test different steepness values (fixing the parameter) within an appropriate range for a species with a life history like that of Gulf of Mexico red snapper. In the configuration of Stock Synthesis we reviewed, the panel concluded that not requiring the recruitment deviations to average to zero was inappropriate because doing so undermines the integrity of the  $R_0$  and  $B_0$  parameters. In the model we reviewed, the recruitment deviations had a positive, upwards trend over time, giving the model the perception that a regime shift was taking place. As a result, the review panel recommends that the option to have the recruitment deviations sum to zero be used.

Several other recommendations from the review panel include smoothing any obvious and known outliers in the input data. The review panel recommends that the age of the population plus group be increased to an older age where there are less than a small percent of fish remaining in the virgin population. We also recommend testing the behavior of the assumed dirichlet distribution for sensitivity of the parameter estimates to sample size starting values. Finally, to develop the sensitivity analysis that the review panel identified, we recommend that a matrix of possible and plausible combinations of parameters and processes that the analysts wish to test be developed to ensure a balance between testing the most important aspects of uncertainty while maintaining an appropriate workload.



# SEDAR

Southeast Data, Assessment, and Review

---

## SEDAR 74

### Gulf of Mexico Red Snapper

#### SECTION VI: Review Workshop Report

**January 2024**

SEDAR  
4055 Faber Place Drive, Suite 201  
North Charleston, SC 29405

**Table of Contents**

Table of Contents ..... 2

1. INTRODUCTION ..... 2

    1.1 WORKSHOP TIME AND PLACE ..... 2

    1.2 TERMS OF REFERENCE ..... 2

    1.3 LIST OF PARTICIPANTS..... 3

    1.4 LIST OF REVIEW WORKSHOP WORKING PAPERS AND DOCUMENTS ..... 6

2. REVIEW PANEL REPORT..... 6

**1. INTRODUCTION**

*1.1 WORKSHOP TIME AND PLACE*

The SEDAR 74 Review Workshop was held in Tampa, Florida December 12-15, 2023.

*1.2 TERMS OF REFERENCE*

1. Evaluate the data used in the assessment, including discussion of the strengths and weaknesses of data sources and decisions. Consider the following:
  - Are data decisions made by the Data and Assessment processes justified?
  - Are data uncertainties acknowledged, reported, and within normal or expected levels?
  - Is the appropriate model applied properly to the available data?
  - Are input data series sufficient to support the assessment approach?
  
2. Evaluate and discuss the strengths and weaknesses of the methods used to assess the stock, taking into account the available data. Consider the following:
  - Are methods scientifically sound and robust?
  - Are priority modeling issues clearly stated and addressed?
  - Are the methods appropriate for the available data?
  - Are assessment models configured properly and used in a manner consistent with standard practices?
  
3. Consider how uncertainties in the assessment, and their potential consequences, are addressed.
  - Comment on the degree to which methods used to evaluate uncertainty reflect and capture the significant sources of uncertainty in the population, data sources, and assessment methods.
  - Comment on the likely relationship of this variability with possible ecosystem or climate factors and possible mechanisms for encompassing this into management reference points.

4. Provide, or comment on, recommendations to improve the assessment
  - Consider the research recommendations provided by the Data and Assessment processes in the context of overall improvement to the assessment, and make any additional research recommendations warranted.
  - If applicable, provide recommendations for improvement or for addressing any inadequacies identified in the data or assessment modeling. These recommendations should be described in sufficient detail for application, and should be practical for short-term implementation (e.g., achievable within ~6 months). Longer-term recommendations should instead be listed as research recommendations above.
5. Provide recommendations on possible ways to improve the Research Track Assessment process.
6. Prepare a Review Workshop Summary Report describing the Panel’s evaluation of the Research Track stock assessment and addressing each Term of Reference.

1.3 LIST OF PARTICIPANTS

**Review Panel**

Jim Nance (Chair) .....	GMFMC SSC
Mike Allen .....	GMFMC SSC
Matt Cieri .....	CIE Reviewer
Patrick Cordue .....	CIE Reviewer
Edvin Fuglebakk .....	CIE Reviewer
Sean Powers .....	GMFMC SSC
Steven Saul.....	GMFMC SSC

**Analytic Team**

LaTreese Denson .....	NMFS SEFSC
Matt Smith .....	NMFS SEFSC
Katie Siegfried .....	NMFS SEFSC

**Appointed Observers**

Pat Neukam.....	Charter/Commercial Fisherman
Dylan Hubbard.....	Fisherman

**Council Representation**

JD Dugas.....	Louisiana
Tom Frazer .....	Florida

**Staff**

Julie A Neer .....	SEDAR
--------------------	-------

Ryan Rindone..... GMFMC Staff  
 Charlotte Schiaffo ..... GMFMC Staff

**Workshop Observers**

Luiz Barbieri ..... FWC  
 Max Birdsong..... GMFMC Staff  
 John Froeschke..... GMFMC Staff  
 Michael Drexler ..... Ocean Conservancy  
 Carissa Gervasi ..... NMFS SEFSC  
 Tiffany Hopper..... TPWD  
 Challen Hyman ..... USF  
 Emily Muehlstein..... GMFMC Staff  
 Bernie Roy ..... GMFMC Staff  
 Beverly Sauls ..... FWC  
 Carrie Simmons ..... GMFMC Staff  
 Carly Somerset..... GMFMC Staff  
 Molly Stevens ..... NMFS SEFSC  
 Andy Strelcheck ..... SERO  
 Nathan Vaughan..... NMFS SEFSC  
 Ed Walker ..... GMFMC  
 Sean Williams ..... FWC

**Workshop Observers via Webinar**

Jason Adriance ..... LADWF  
 Lisa Ailloud ..... NMFS SEFSC  
 Steven Atran.....  
 Kevin Anson ..... GMFMC  
 Hannah Aycock.....  
 Kelsey Banks ..... TAMUCC  
 Scott Bannon..... AL DCNR  
 Jeff Barger..... Ocean Conservancy  
 Beverly Barnett ..... NMFS SEFSC  
 Samantha Binion-Rock ..... NMFS SEEFSC  
 Kristan Blackhart ..... NOAA  
 Harry Blanchet..... LADWF  
 Ken Brennan ..... NMFS SEFSC  
 James Bruce .....  
 Shannon Cass-Calay ..... NMFS SEFSC  
 David Chagaris..... UFL  
 Rob Cheshire..... NMFS SEFSC

Manuel Coffill-Rivera.....	
Chip Collier.....	SAFMC Staff
Juan Cortes.....	
Tiffanie Cross.....	FWC
Judd Curtis .....	SAFMC Staff
David Die .....	University of Miami
Leonardo Eguia.....	
Thomas Flanagan .....	
Francesca Forrestal .....	NMFS SEFSC
Steve Garner.....	NOAA
Dakus Geeslin .....	TPWD
Bob Gill.....	GMFMC
Martha Guyas.....	ASA
David Hanisko .....	NMFS SEFSC
Katie Harrington .....	Mote Marine Lab
Meisha Key .....	SEDAR
Michael Larkin.....	SERO
Max Lee .....	Mote Marine Lab
Mara Levy.....	NOAA
Susan Lowerre-Barbieri .....	FWC
Daniel Luers.....	NOAA
John Mareska .....	ALDCNR
Vivian Matter .....	NMFS SEFSC
Maria McGirl .....	FWC
Jack McGovern .....	SERO
Matthew Nuttall .....	NMFS SEFSC
Adam Pollack.....	NMFS SEFSC
Chloe Ramsay .....	FWC
Ashford Rosenberg .....	Shareholders Alliance
Skyler Sagarese.....	NMFS SEFSC
Chris Schieble .....	LADWF
Mike Schmidtke .....	SAFMC Staff
Camilla Shireman.....	
Matt Streich.....	TAMUCC
Kevin Thompson.....	NMFS SEFSC
James Tolan .....	TPWD
Brendan Turley .....	NMFS SEFSC
Ana Vaz .....	NMFS SEFSC



1.4 LIST OF REVIEW WORKSHOP WORKING PAPERS AND DOCUMENTS

<b>Documents Prepared for the Review Workshop</b>			
SEDAR74-RW-01	Using stakeholder knowledge to better understand uncertainty in the Gulf of Mexico red snapper stock assessment mode	Carissa L. Gervasi, Matthew McPherson, Mandy Karnauskas, J. Marcus Drymon, Evan Prasky, Hannah Aycock	Submitted: 24 November 2023

**2. REVIEW PANEL REPORT**

**Executive Summary**

The Research Track Assessment (RTA) of Gulf of Mexico red snapper (SEDAR 74) was reviewed in Tampa, Florida, in a four-day, in-person meeting from December 12-15, 2023. The Review Panel including three CIE appointed reviewers and three members of the Gulf of Mexico Fishery Management Council’s Scientific and Statistical Committee.

**Data**

SEDAR 74 faced challenges due to inadequate preparation of composition data, leading to flawed model runs. Excluding valuable age-composition data for landings raised concerns. The Data working group provided well-prepared landing and discard streams but faced issues with composition data and the Great Red Snapper Count (GRSC). Premature inclusion of GRSC estimates without quantifying biases and lacking composition data is cautioned. Concerns about the GRSC's single point estimate without length composition and attention to variability sources suggest its current inclusion is unwarranted. Future assessments should emphasize data quality and relative value. Challenges also arose in estimating total removals, especially due to uncertainties in recreational landings and discards. The Data Workshop recommended acknowledging this uncertainty through coefficient of variation (CV) calculations for different time periods. Concerns arise from differences in data input and CVs between MRIP FES and previous assessments, requiring explicit investigation for accurate modeling. SEDAR 74 used Stock Synthesis with over 2,000 parameters, raising concerns about potential over-parameterization. The model's reliance on known catch and relative biomass trends is compromised by high uncertainty in total removals, resulting in model convergence issues, and its tendency to alter input data without clear justification is undesirable. Given crucial uncertainties in discards and recreational landings, exploring sensitivities is recommended to understand model sensitivity and bias. SEDAR 74 used a complex three-area model, absent representative composition data which hindered justification of the model's complexity. The eastern region lacked sufficient data, and composition and GRSC data were inadequate for this structure, emphasizing the importance of using representative data.

**Assessment Methods**

The Gulf of Mexico Red Snapper fishery is unique, with documented fishing not representing most mortality. Recreational and discard fisheries, often underreported, posed challenges. The Assessment Team addressed this with standard tools but acknowledged uncertainties; the chosen methods are considered the best available. Priority modeling issues are clearly stated and most are addressed by the model proposal or discussed in the workshop report; however, their relative importance was not made explicit. The main purpose of a stock assessment model is to produce good estimates of the quantities required for management. Concerns about which data sources to include and how to structure the model should be resolved.

The SEDAR 74 model was seemingly fit for available data; however, concerns arose about weak constraints on some variables without clear explanations. The Review Panel questioned the model's appropriateness for the available data. Insufficient information is provided to determine if the proposed model is suitable, emphasizing the need for robust parameterization with operationally available data. Other notable issues include a fixed steepness in the recruitment function, potentially overlooking stock size impacts, and an unclear distinction between shifts in population productivity and random fluctuations in recruitment. Age-structure modeling and biomass indices faced configuration challenges, with data source weighting and other model parameters lacking sufficient justification. SEDAR 74 struggled to capture uncertainty, particularly in data inputs and model parameters. Data reweighting was inconsistent, sometimes contradicting higher CVs. Parameter uncertainty was estimated with asymptotic standard errors, providing a minimum uncertainty estimate compared to other robust methods. Limited exploration of sensitivities, including crucial factors like natural mortality and index weight, posed challenges in understanding model behavior and guarding against misspecification. SEDAR 74 did not consider ecosystem and climatic factors, which can influence key parameters. Reference points and projections were unavailable.

### **Improving the Assessment**

The analysts followed some Review Panel recommendations for improving SEDAR 74, such as stock area modeling and adjusting natural mortality. However, conflicting recommendations between the assessment report and the Review Panel were noted. Further improvement in data and modeling approaches is suggested to address identified issues, including data preparation, model configuration, and spatial structure. Other recommendations include scaling and converting length data to age data, simplifying the model, and addressing biases in the GRSC data. The Review Panel also suggests sensitivity analyses for catch uncertainties, varied steepness values, and adjustments to recruitment deviations. Concerns about model complexity, spatial delineation, and data biases highlight the need for continuous improvement in the assessment process and careful consideration of model components.

An RTA cannot guarantee an improved stock assessment model in a given timeframe. Thus, an operational stock assessment process independent of such research should be maintained. Improved models or methods can be used in the operational process as they are developed, but their development should not delay management advice. The Research Track/Management Track system employed in the Northeastern U.S. is a good example of this. RTAs should only be conducted if the resources necessary will be available, including properly prepared data, standard diagnostics, and bridging and continuity runs.

Data sources to be included in the model were too rigid, and the Assessment Team had little opportunity to remove or modify data streams that may have been inappropriate, or in some cases, had little ability to change CVs unless the model failed to converge. Moreover, the data process itself did not lend itself well to multiple model configurations explored in tandem with the planned configuration. How the various data streams are best parsed is often unknown until sensitivities are explored and various potential model configurations are retained or discarded. As such, more flexibility is likely required in both the data and assessment process. An additional issue was the transitioning of model diagnostics, sensitivity analysis, reference point construction, and projections from the RTA to the operational assessment. This is not typical; fully formed models complete with diagnostics, sensitivities, reference points, and in some cases, projections are normally included when reviewing an RTA. This allows for complete transparency of how the proposed model is functioning, and for both internal and external reviewers to comment on elements that are important to the management process. The Review Panel recommended determining which aspects of the previous benchmark process are best examined in an RTA, and which are best moved to the operational assessment.

## **Conclusion**

The Review Panel thanks the analysts for their good and substantial work, and their openness to discussion and criticism. SEDAR 74 faced several challenges, and the proposed model is not ready for further development without substantial additional work and review.

## **Panel Summary Report**

### **Introduction**

The Research Track Assessment of Gulf of Mexico (GOM) red snapper was reviewed in Tampa, Florida, in a four-day, in-person meeting from 12-15 December 2023. The Review Panel consisted of a Chair and six reviewers including three CIE appointed reviewers. This report summarizes the findings of the Review Panel in regard to the terms of reference of the review.

The report was agreed to by each of the reviewers and the Chair wrote the Executive Summary. The three CIE reviewers also wrote individual reports.

The Review Panel's comments on each of the terms of reference are given below.

### **Data Used In Assessment**

#### ***Are data decisions made by the Data and Assessment processes justified?***

The purpose of the research track SEDAR was to develop a reasonably complete specification of model structure and data sources for a GOM red snapper stock assessment. Unfortunately, the inadequate preparation of the composition data meant that this objective could not be achieved.

The composition data used in the model runs were “raw” or “nominal” in that they were not stratified and scaled to be representative of the sampled fishery catch/discards or the surveyed population. The decision to proceed with raw composition data and to use model runs with such data to make decisions on ideal model structure and the inclusion or exclusion of data sources was flawed. Decisions based on such model runs are not defensible because it can always be argued that different conclusions would have been reached had the representative composition data been used.

We are particularly concerned about the decision to exclude available age-composition data for commercial and recreational landings, as age compositions are generally expected to be more informative than length compositions. While careful considerations for that decision were presented to the Review Panel, those were mostly informed by analysis on preliminary and non-representative data. The decision was also partly motivated by some indicators of model fit being better for length-composition data than age-composition data. As the model fitted was an age-structured model, those results could also be interpreted as an indication of model-misspecification. Given the well-established value of age data for stock assessments, the decision to not include them in age-structured models should ideally be motivated by data quality issues, such as bias, or difficulties in age-reading.

The Data working group supplied landing and discard streams, composition data, and indices for each of the three areas specified by the Stock Identification working group. The data and indices were adequately prepared except for the composition data, as already noted, and the Great Red Snapper Count (GRSC) which requires further analysis before it can be used in a stock assessment (see below). Careful consideration was given to which indices to include but some of the fishery-dependent time series could perhaps be excluded (further consideration should be given to whether they are likely to be hyper-stable).

It was premature to include the GRSC estimates in the model as potential biases have not been quantified and composition data were not available. It is unlikely that the selectivity for the survey estimates is uniform across ages 2 years and older (as claimed in Stunz et al. 2021). Composition data are needed in each area to estimate the selectivities which are expected to vary across areas, dependent on the different survey methods used. The use of the estimates as absolute abundance (“catchability” or  $q = 1$ ) is not appropriate as there may be bias, especially if  $q$  is greater than 1. The potential for bias in the estimates is obvious in the comparisons of density estimates from acoustics and ROV methods. The average density from the ROV was approximately 9 times higher than the average density from acoustics at the same stations (Stunz et al. 2021, Figure 7). The acoustic method may produce under-estimates of density, but there are reasons why the ROV could be producing over-estimates (e.g. species identification, potential double counting on the four orthogonal transects at each station, and attraction of red snapper to the ROV, including the tether). The biases for the methods used in the GRSC need to be quantified and used to produce informed priors for the associated catchabilities ( $q_s$ ) before the estimates can be used in a model.

During the Review Meeting concern was expressed by members of the Review Team that the GRSC estimates should be included in the model as an alternate hypothesis of adult abundance. However, given the time and resources allocated to this impressive GRSC effort, it is important to note that just because data, either fishery independent or dependent, are not included within an assessment model doesn't mean these data or surveys are not valuable. On the contrary, such data or surveys can be invaluable by providing cross-checking of assumptions, informing priors, and in some cases providing valuable information that can be useful when making parameter assumptions or choosing an appropriate precautionary buffer to account for uncertainty. The reported CV around the point estimate in the GRSC is likely much greater than the  $< 0.3$  that was estimated. Several other sources of uncertainty and variability were not included for all subregions. These include  $q$  for the various gears and uncertainty in the abundance of habitat types. It is also important to note that the original intent of the study was to provide an independent (outside the assessment) estimate of age 2+ year old red snapper and was not designed to be a survey for use in the assessment,

As is, the single point estimate of abundance without length composition or more attention to estimating  $q$  and capturing other sources of variability (e.g., uncertainty in habitat mapping) its inclusion does not seem warranted. It should be noted that many of these data sources were available in the GRSC report, the archived data, or could have been obtained from the PI's, the analysis team felt that they did not have sufficient resources to prepare all of these data. We encourage the analysis team to perform these data inquiries if future assessments wish to incorporate results from the GRSC.

***Are data uncertainties acknowledged, reported, and within normal or expected levels?***

The Data working group recommended CVs for different time periods to acknowledge the uncertain estimates of landings and discards. They also supplied the estimated CVs that were calculated from sampling designs (landings and indices) and CPUE analyses. The key feature of this assessment is that total removals are very uncertain. This is primarily due to the large components of recreational landings and discards within the total removals from the population. The key challenge of the assessment is to properly incorporate the uncertainty of total removals into the modeling framework. Recreational data are based on MRIP FES (FCAL series), in contrast to the previous red snapper assessment which was series (ACAL Series). The difference in the data input and CV's around these catches should be more explicitly investigated, especially in light of recent studies that documented a high degree of telescoping error in the new FCAL series. Again, this is important because the model requires catch to be known with a high degree of certainty.

***Is the appropriate model applied properly to the available data?***

A model developed within the SS3 modeling package is appropriate for the available data, but the model is highly complex with over 2,000 parameters and many of those are uninformed by

data (i.e., likely overparameterization). The SS3 package is specifically designed to deal with these types of data (multiple landing and discard streams across specific areas and area-specific biomass/abundance and composition times series). However, the basis on which these types of models obtain information on levels of virgin and current biomass is undermined by great uncertainty in total removals. Although there are many “bells and whistles” the basic principle of these models is that known catch (landings plus dead discards) and the relative trend in biomass (e.g., a decline of 30% in the last 10 years) allow the starting biomass to be estimated (i.e., taking large catches, relative to the starting biomass, causes biomass to decline; taking small catches leads to little change in biomass).

The Assessment team fitted the landing and discard streams within the model as uncertain quantities (annual CVs applied to the estimated landings and discards). When the recommended (large) CVs were used the model failed to converge to an estimate. As already noted, this is perhaps to be expected. When smaller CVs were used (and thus total removals were assumed to be more accurately known than they are) then the model was able to converge. However, the model changed some of the annual landings and discards to improve fits to other data within the model. This is an undesirable feature of this approach. Without a clear explanation on how removals may be determined by model assumptions and other data sources, we do not find that the model has genuine information to change input landing and discard streams. While discards and recreational landings are commonly modeled as uncertain quantities in other fisheries, they usually represent a minor contribution to total removals. In those cases, these uncertainties are of little consequence, but in the GOM red snapper fishery they are the most important contributors to fishing mortality. We therefore find that it is far better for the analysts to run many alternate plausible scenarios of landing and discard streams that are assumed known when input into the model. In this way the uncertainty, and potential bias, in landings and discards and the sensitivity of model results to those uncertainties can be fully explored and the assumptions used for final inference can be made explicit.

***Are input data series sufficient to support the assessment approach?***

The Assessment team used a three-area model with explicit modeling of landings and discards. The model had over 2,000 parameters and appeared to need more data and better-quality data than was available. A conclusive analysis of whether such model complexity can be justified by the available data would require representative composition data, which was not available to the Assessment team. Still, some modeling choices reveal data gaps that would not be filled even when issues in data preparation are addressed. In particular, the eastern area was quite data poor, and many of the parameters had to be borrowed from the central region. On balance, the Review Panel thought that a return to the two-area model (as a base model) would be more appropriate for now. When more data are available for the eastern area then a three-area model could be developed and considered.

As already noted, the composition data and the GRSC data were not adequately prepared to support the purpose of the research track SEDAR. Decisions on model structure and data sources for a particular stock assessment require that representative composition data are used and biomass indices are unbiased (i.e.,  $q = 1$  for the GRSC estimates was not appropriate).

### **Assessment Methods Strengths and Weaknesses Taking into Account Available Data**

#### ***Are methods scientifically sound and robust?***

The GOM Red Snapper fishery is peculiar in that fishing documented via census reporting does not constitute the majority of fishing mortality. Recreational fisheries and discard from all fisheries are of very high importance, but only documented through sampling and self-reporting. The discard fraction is particularly challenging as discard survival is very uncertain and demographic variables (age or length) are mostly not available for this component. The Assessment Team has attacked this challenge with standard assessment tools for well-documented fisheries but has recognized the fishery-specific uncertainties and taken advantage of the flexibility of a standard assessment framework (SS3) in order to account for them. We have not been able to identify generic modeling approaches that are better suited, and find that the methods chosen are sound, in the sense that they constitute the best available scientific approach. Apart from exceptions explicitly treated in this report, we find that the model is formulated with good justification and in accordance with currently recommended practices. Uncertainties are thoroughly mapped and documented, and either explicitly modeled or identified for sensitivity analysis. We are not convinced that the data contains information about all of the aspects modeled with free parameters, and therefore have some concerns about the robust application of the methods to operational assessments.

#### ***Are priority modeling issues clearly stated and addressed?***

Priority modeling issues are summarized by Terms of Reference 1-4 for the SEDAR 74 Assessment Process Workshop. These are clearly stated and most of them are addressed by the model proposal or discussed in the workshop report.

Specifically:

- Deviations from data workshop recommendations are explicitly justified in workshop report (ToR 1)
- The model proposal incorporates absolute abundance estimates from “The Great Red Snapper Count” and the approach is discussed in the workshop report. (ToR 2a)
- The model has elaborately modeled selectivity and retention curves for all fleets, and their formulation and parameterization are discussed in the workshop report. (ToR 2b)
- The Connectivity Modeling Simulation recruitment index is addressed in the report, it was not incorporated into the model as the quantities it is believed to support was not considered as part of the scope of the research track assessment. (ToR 2c)

- The model explored using length composition data instead of age composition data for some of the fleets where age-length keys have been used in estimating age compositions. (ToR 2d)
- It is not clear if any investigation into estimating growth within the model was attempted. (ToR 2e)
- Estimability and model stability was investigated with respect to recreational fleet selectivity functions. (ToR 2f)
- Apart from sex ratio, the stock population parameters prioritized are all included in the model. However, some selectivities and some parameters of the stock-recruitment relationship are kept fixed to maintain model stability. (ToR 3a)
- Most relevant uncertainties in input data are recognized, many of them are explicitly modeled, others are indicated for sensitivity analysis (ToR 4a).
- Preliminary measures of model performance, reliability and goodness-of-fit has been provided. Final diagnostics was not justified by the preliminary composition data (ToR 4b).

While priority modeling issues are clearly stated and addressed, their relative importance was not made very explicit. The main purpose of a stock assessment model is to produce good estimates of the quantities required for management. These are summarized in ToR 3a of the SEDAR 74 Assessment Process Workshop. Concerns about which data sources to include and how to structure the model should primarily be resolved in support of this goal. Since many of the issues we have identified in this review relate directly to how the Assessment Team has tried to accommodate the other Terms of Reference, it may be worth considering if their mandate has been too prescriptive.

***Are the methods appropriate for the available data?***

The Assessment team has utilized the SS3 modeling package to implement a model that is well suited to the available types of data sources (landing/discard statistics, relative biomass indices and composition data). Some variables related to landings and discards are modeled with weak constraints, without a clear explanation for how available data informs their parameterization. This is a major concern for the Review Panel, and has been discussed in more detail in our treatment of “Data used in Assessment - Are input data series sufficient to support the assessment approach?”. With respect to the modeling of removals, we find that the proposed model is not appropriate for the available data.

The Assessment Team has not provided sufficient diagnostics to demonstrate that the model can be robustly parameterized with operationally available data. This is mainly because the upstream data preparation has not been adequate to enable conclusive diagnostics, as the team has had to work with non-representative composition data. This too has been discussed earlier in this report (“Data used in Assessment - Are input data series sufficient to support the assessment



approach?”). With respect to model parameterization, we are not able to conclude if the proposed model is appropriate for the available data.

***Are assessment models configured properly and used in a manner consistent with standard practices?***

Apart from issues discussed elsewhere, we identified some deviations from standard practices that would warrant more careful justification.

The recruitment function was configured with a steepness fixed at 0.99, which essentially makes average recruitment completely independent of stock size. While the stock-recruitment relationship may be weak, it is clear that very low stock sizes must produce very low recruitment, and that should preferably be reflected in the model. Also, the model was configured without constraints on the average recruitment deviations, in order to account for unknown causes of shifts in population productivity. It is not clear how either the analysts or the model distinguishes shifts in population productivity from random fluctuations in recruitment. If lasting shifts in population productivity is recognized, the temporal changes in stock-recruitment relationship must be explicitly modeled, least projections may be biased by earlier trends. Non-lasting extreme deviations from the expected recruitment are best captured by the recruitment deviations, but the presence of such deviations will lead to bias in projections unless the average recruitment deviations should be constrained to 0.

The age-structure was specified with a model plus-group well below the maximal age of the fish, and the data plus-group was configured such that the plus-group is the largest age-group for some data sources. In order to utilize the full age-resolution, the model plus-group should be set high enough that it only contains a very small fraction of the total population, and data plus-groups should be set high enough that they only contain a very small fraction of the sampled ages.

Biomass indices were configured with the same mean CV, even if they are not of equal precision and should not be weighted equally. The Assessment Team considered that the CVs suggested by the data workshop were not comparable and could not be used directly. Even so, a better approach than equal weighting would be to decide on CVs that reflect the suspected uncertainties in the data. The concept of CVs are commonly also pragmatically expanded in modeling with SS3 to reflect suspected biases in data sources. This provides a mechanism for the appropriate weighting of indices. In particular, it would be of interest to reflect the greater uncertainty in biomass trends reflected in fisheries-dependent CPUE indices. Alternatively, a data reweighting method could be used (e.g., so that for each time series the standard deviation of the normalized residuals is not too different from 1).

In principle, data source weighting can also be achieved in SS3 by emphasis factors / lambda weighting factors. Unfortunately, that compromises the interpretation of some key diagnostic tools. Lambdas should not however be used to force the model to fit unreliable data, as was done

for some discard data and recreational landing data. A better approach would be to remove or adjust outliers in the data.

With respect to model configuration, we find that not all deviations from standard practices have been adequately justified.

## **How Assessment Uncertainties and Potential Consequences are Addressed**

***Comment on the degree to which methods used to evaluate uncertainty reflect and capture the significant sources of uncertainty in the population, data sources, and assessment methods.***

Uncertainty in the assessment and its outputs was not well captured. Uncertainty for the input data was included, but sometimes qualitatively scaled to increase model fit. Additionally, changes in lambdas were used to reweight data sources to promote model fitting and reweight the data sources qualitatively. This resulted in, for example, the use of lambdas to increase data source weight within the model, despite that source having higher CVs which should actually lower its weighting.

Uncertainty in parameters was captured by using asymptotic SEs calculated from the inverted Hessian matrix after model fitting. This contrasts other approaches in the region which use MCMC (Markov chain Monte Carlo) or MCB (Monte Carlo Bootstrapping). As such the error estimates derived using asymptotic SEs are a minimum estimate of uncertainty in the model outputs. Because MCMC or MCB generally are computationally intensive, such approaches should only be attempted once a base model is selected.

Further examination of uncertainty was only lightly examined. While some sensitivities were analyzed, including sensitivities to Time and Spatially Varying Maturity and Great Red Snapper Count (GRSC) Estimate and Selectivity, a full suite of sensitivities was postponed to the operational assessment process. While understandable given the time and effort limitations, this resulted in standard sensitivities not being analyzed, such as sensitivities to natural mortality, steepness, and index weight within the model. Such sensitivities are critically important in understanding model behavior as well as guarding against misspecification.

***Comment on the likely relationship of this variability with possible ecosystem or climate factors and possible mechanisms for encompassing this into management reference points.***

Ecosystem and climatic factors were not addressed in this assessment, given its complicated structure. These factors can be important in estimations of natural mortality, growth, maturity, and recruitment. However, this would be a difficult proposition given that no evidence of correlation was presented during the assessment or that ecosystem and climatic factors affected these key parameters. Rather than investigate these, it would be best to focus effort and resources on building a more robust base model and examine ecosystem and climatic factors via sensitivity analysis. Additionally, reference points and management advice were not a part of this Research Track assessment.

## **Provide and Comment on Recommendations to Improve the Assessment**

***Consider Data and Assessment Processes Research Recommendations, Improvement to the Assessment, and Additional Longer Term Research Recommendations***

The Review Panel developed a number of conclusions about the assessment, and made recommendations about how some of the issues identified in the conclusions could be addressed. This section of the report shares our recommendations for data and model improvement in light of the conclusions reached about the assessment. The analysts followed the recommendations from the data and assessment meeting as discussed in the assessment report. Some examples of these included stock identification group three stock area model spatial partition, fixing natural mortality for age-0 and age-1 fish at values used during the last assessment, and trialing alternate start years for the model. Please note, however, that some of the recommendations in the stock assessment report are counter to the recommendations made by the Review Panel.

### ***Recommendations for improvement or addressing inadequacies identified in the data or modeling***

As discussed in the data section above, some of the data for model development were not adequately prepared for inclusion into the assessment model. The age and length composition data included in the model were raw and unscaled to the total landings or the distribution of the fleet or survey from which they were collected. The review panel recommended that composition data be properly scaled, as is often done in other SEDAR assessments in the Gulf of Mexico so that the model could be properly evaluated. For example, in a stratified random design, length samples from a fishery would need to be scaled up to the number of fish landed in each stratum to ensure that the length frequency is representative of the total landings from the fishery.

Both age and length data were included in the SEDAR 74 model. Generally speaking, age frequency data provides more information than an associated length frequency. Given that Stock Synthesis is an age-based assessment model, it is preferable to include age frequency data whenever possible. Given that the analysts reported that they had regional, annual, age-length keys generated using data from otolith analyses, we recommend that length frequency data be scaled, converted to age frequency data, and combined with any available scaled age data by year and fleet for inclusion in the model. When age frequency data cannot be included in the model, then we recommend using length frequency if that is the only composition data available.

The configuration of the SEDAR 74 model that was presented to the reviewers was very different from the configuration used in the prior red snapper assessment. This was to be expected especially given the nature of a research track assessment, which is meant to explore alternative ways of configuring the assessment model and parsing the data. However, regarding the process, we recommend that continuity runs and bridging analyses be incorporated into the process. In this context, we are referring to continuity runs as those where the previous version of the model is updated with new data and run. Bridging is defined as making one change to the old model at a time and rerunning the model after each successive update, as an iterative methodology for arriving at a newly configured model while documenting each change made and its effect on the model. Another important recommendation regarding the research track

process is that the calculation and presentation of standard diagnostics should be required to allow analysts, reviewers, and other stakeholders to best evaluate the model.

Age-structured models fitting relative biomass indices rely on the catch to be assumed to be known accurately to estimate population biomass. This assessment specified high coefficients of variation (CVs) on the removals to capture uncertainty in the landings. Although specifying this uncertainty is important, models like Stock Synthesis are designed to assume that the landings are known and with fairly high precision. Specifying high CVs on the removals provides flexibility to the model and causes Stock Synthesis to not fit the landings precisely, which can undermine the basis of these types of models. To handle uncertainty in the removals, we recommend developing several different sensitivity analysis scenarios (potentially a high, medium and low catch scenario) to test how different catch quantities could vary the model results. For each sensitivity analysis, maintain low CVs for the catch time series (see Francis 2017: Revisiting data weighting in fisheries stock assessment models, *Fisheries Research*, 192: 5-15).

All of the abundance indices were provided the same mean CV when they were input into Stock Synthesis. Assigning all indices to have the same CV does not consider the actual uncertainty behind each estimated annual index value and also informs Stock Synthesis that all indices are equally precise, which is not true. We recommend initially applying the CV from each annual estimate of the index, then applying a reweighting procedure to the indices to ensure the input variance assumptions are consistent with the output variance results. In addition, consider removing fishery dependent catch per unit effort indices given the number and quality of fishery independent indices available for this species. Incorporating fishery dependent indices could be a sensitivity analysis. It is important to acknowledge that for many species assessed in the Gulf of Mexico, we do not have enough or adequate fishery independent indices, and thus need to rely on including fishery dependent indices into these stock assessments. However, for red snapper, there are a number of fishery independent indices available that probably represent a more reliable index of abundance than fishery-dependent data sources.

The review panel found the stock assessment model to be overly complex, and discussed recommendations for how the model could be simplified. One of the ways we thought the model could be simplified was by incorporating the discarded catch either directly into the landings or as its own fleet, instead of having the model try to fit to the discards. This would reduce the number of parameters that need to be estimated by eliminating retention functions for each time block associated with each fleet with discards. To accomplish this, external to Stock Synthesis, if needed, we recommend applying the discard mortality rate to determine the total number of dead discards. Given that there is uncertainty and potential bias in discarded catch, several different scenarios developed using the CVs of the discards (perhaps a low, medium and high scenario) could be sensitivity tested. If the dead discards are combined with landings to make up total removals prior to input into SS3, combine the discard length frequency data with the length frequency data from the landed catch; properly scale the discard composition data and the

composition data from the landed catch. If incorporating discards as a fleet, then pair properly scaled discard composition data with the discard fleet.

Another way that the review panel thought the complexity of the model could be simplified was to reconsider the spatial structure of the model. The review panel recognizes that Gulf of Mexico red snapper are one stock from a biological, assessment, and management perspective. The stock identification group identified three potential sub-populations and recommended a three-area spatial structure be applied to the stock assessment model. There may be compelling reasons to model the stock in multiple areas, such as when there are differences in biology or population genetics, or differences in fisher behavior or fleet structure. The review panel acknowledges that there are some differences in fishing behavior and species targeting that differentiate the West Florida Shelf from the Panhandle of Florida and waters west of the Mississippi River.

The review panel recognizes that an important part of the SEDAR process is the development of consensus decisions by the stakeholders involved regarding the analysis and incorporation of data streams into the assessment, and the structure of the assessment model. This is a very useful way to ensure that important components of the system are captured in the data analysis and the assessment. However, the assessment scientists are those who are most knowledgeable about the implications of such decisions on the outcome of the Stock Synthesis model. As such, we recommend that the final decision on model spatial structure be made by the assessment analysts, given the information provided by the stakeholders together with their knowledge of available data, their respective sample sizes in each area, and fishing behavior. In this assessment, there were a limited number of data samples in the central region. As such, despite possible differences in fisher behavior between that region and the West Florida Shelf, the review panel recommended that the eastern and central region not be modeled separately.

In addition, the review panel found that the spatial delineation between the central region and the West Florida Shelf incorporated too much of the directed grouper fishing grounds into the central region such that the boundary would need to be reconsidered if a three-area model were to be pursued. Ultimately, the review panel recommended returning to a two-area model configuration. As the red snapper stock continues to rebuild, especially in areas east of the Mississippi River, more data on red snapper catch and composition will be available potentially making it possible to support a three-area model in the future. The review panel also recommended that a three area model could be developed as a sensitivity analysis. However, the review panel also recognizes that requesting multiple spatial partitions places an additional workload on the data preparation team in the SEFSC and may not be feasible given current work assignments, until such processes are more automated.

Data from the GRSC were included in the stock assessment model as a one-year index of absolute abundance, by assigning it a catchability coefficient of 1 in the abundance index section of Stock Synthesis. After reviewing the Great Red Snapper Count documentation, the review panel (with the abstention of Dr. Sean Powers, one of the study PIs) determined that there were

potential biases that had not been quantified and needed to be considered prior to including this information into the stock assessment. As discussed in an earlier section of this report, there is potential bias in the estimates of absolute abundance. As described, the average density estimated from the ROV sampling was nine times higher than the density estimated from acoustics at the same sampling stations. Due to differences like these, it is unlikely that the catchability ( $q$ ) is equal to 1.

The review panel recognizes the GRSC data as a valuable source of information, regardless of whether it is used directly in the stock assessment. To consider including this data directly into the stock assessment model, the review panel recommends that the biases for the methods used in the GRSC be quantified and used to develop informed priors for the catchability of each sampling method, and an overall catchability prior for the survey as a whole. The review panel recommends that the calculated catchability prior then be used in the Stock Synthesis model to inform the estimation of catchability ( $q$ ) for the GRSC estimates. This will allow the GRSC estimates to be most appropriately included in the Stock Synthesis model. In addition, assuming the selectivity for the survey is uniform across ages two and older is not appropriate. The review panel recommends incorporating the associated GRSC length frequency data into the assessment (after properly scaling the data), which could then help inform an associated estimated selectivity function.

The review panel agreed that fixing the steepness ( $h$ ) of the stock-recruitment relationship at 0.99 does not properly reflect the life history characteristics of this species; doing so essentially generates the same average recruitment regardless of almost any stock size. Under this model configuration, the recruitment deviations were the only influence varying recruitment levels from one year to the next. If steepness cannot be estimated, or when allowed to be estimated, produces estimates at or close 0.99, then the review panel recommends developing several sensitivity analyses that test different steepness values (fixing the parameter) within an appropriate range for a species with a life history like that of Gulf of Mexico red snapper. In the configuration of Stock Synthesis we reviewed, the panel concluded that not requiring the recruitment deviations to average to zero was inappropriate because doing so undermines the integrity of the  $R_0$  and  $B_0$  parameters. In the model we reviewed, the recruitment deviations had a positive, upwards trend over time, giving the model the perception that a regime shift was taking place. As a result, the review panel recommends that the option to have the recruitment deviations sum to zero be used.

Several other recommendations from the review panel include smoothing any obvious and known outliers in the input data. The review panel recommends that the age of the population plus group be increased to an older age where there are less than a small percent of fish remaining in the virgin population. We also recommend testing the behavior of the assumed dirichlet distribution for sensitivity of the parameter estimates to sample size starting values. Finally, to develop the sensitivity analysis that the review panel identified, we recommend that a matrix of possible and plausible combinations of parameters and processes that the analysts wish

to test be developed to ensure a balance between testing the most important aspects of uncertainty while maintaining an appropriate workload.

### **Provide recommendations on possible ways to improve the Research Track Assessment process**

A Research Track Assessment (RTA) cannot be guaranteed to deliver an improved stock assessment model in a given timeframe. Therefore, it is important to maintain an operational stock assessment process that is largely independent of research aimed at improving stock assessment methods or particular stock assessment models. Improved models or methods can be used in the operational stock assessment process as they are developed, but the development should not delay the provision of management advice. The Research Track/Management Track system employed in the North East Region is a good example of this sort of approach.

It is crucial for an RTA that appropriate resources be made available so that the RTA uses properly prepared data. In addition to properly prepared biomass/abundance indices, representative composition data are required. The very latest data are not needed, but the data that are used must be properly prepared. This enables decisions on model structure and the inclusion or exclusion of data sources to be made based on model runs and the evaluation of standard diagnostics. Bridging and continuity runs from the previously accepted stock assessment are also desirable.

A clear theme during the Review Workshop was that the data phase and data sources to be included in the model were too rigid, and it appeared that the Assessment Team had little opportunity to remove or modify data streams that may have not been appropriate for inclusion, or in some cases, had little ability to change CVs unless the model failed to converge. Moreover, the data process itself did not lend itself well to multiple model configurations explored in tandem with the planned configuration. Often during the modeling process, one doesn't know how the various data streams are best parsed until sensitivities are explored and various potential model configurations are retained or discarded. As such, more flexibility is likely required in both the data and assessment process to account for these eventualities.

An additional issue uncovered during the Review Workshop was the transitioning of model diagnostics, sensitivity analysis, reference point construction, and projections from the Research track to the Operational assessment. This is not typical when comparing the Gulf of Mexico region to other regions in the US, such as the North Pacific, Northeast, and West Coast. In those regions, fully formed models complete with diagnostics, sensitivities, reference points, and in some cases, projections are normally included in the Research Track process. This is an important step because it not only allows for complete transparency of how the proposed model is functioning but also allows for both internal and external reviewers to comment on elements that are important to the management process. For example, by moving projections to the Operational assessment phase, valuable insights on potential time frames over which average



recruitment for projections was not gathered. The Review Panel felt it would be worthwhile to examine the process of other regions to determine what aspects of the previous benchmark process are best examined in the Research Track process, and which are best moved to the Operational/Management Track assessment.

### **Acknowledgements**

The Review Meeting was conducted in a friendly and collegial atmosphere. The Review Panel thanks the Assessment Team for their good work prior to and during the meeting. The Assessment Team clearly spent considerable time and effort on this RTA, and they were open to discussion and criticism on all aspects of the RTA. Thanks also to all of those who organized the review meeting and the provision of documents and data.

### **Conclusion**

The Review Panel acknowledges that the Assessment Team and all contributors to the Data Workshop process invested much time and energy into this Gulf of Mexico Red Snapper assessment. Unfortunately, the current model configuration proposed by the Team is not ready for further development via the Operational Assessment process without considerable additional work, and likely re-review by outside reviewers.

The main drivers for this conclusion included:

- the use of unscaled length and age frequencies that prevented meaningful conclusions from the proposed base model,
- the removal of age composition data given the proposed assessment was an age-structured model,
- the lack of important diagnostics and sensitivity analysis which prevented a full review of the proposed model behavior.
- The data did not support a three-area model.

Because these deficiencies were an integral part of the proposed assessment, it simply was not possible to address the issues during the Review Workshop. Instead, the Review Panel focused its efforts on providing clear recommendations throughout this report on how to address these issues; for this and other stocks in the SEDAR process.