

SEDAR

Southeast Data, Assessment, and Review

SEDAR 70

Stock Assessment Report

Gulf of Mexico Greater Amberjack

October 2020

SEDAR

4055 Faber Place Drive, Suite 201
North Charleston, SC 29405

Table of Contents

Section I. Introduction

PDF page 3

Section II. Assessment Report

PDF page 37

SEDAR

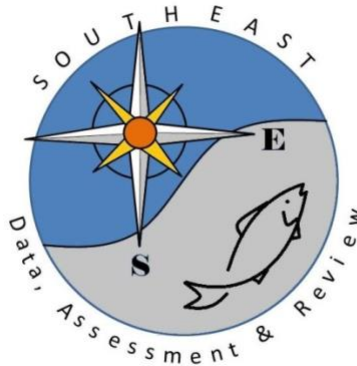

Southeast Data, Assessment, and Review

SEDAR 70

Gulf of Mexico Greater Amberjack

SECTION I: Introduction

SEDAR
4055 Faber Place Drive, Suite 201
North Charleston, SC 29405

Introduction

SEDAR 70 addressed the stock assessment for Gulf of Mexico greater amberjack. The assessment process consisted of a series of webinars. Data and Assessment webinars were held between June and September 2020.

The Stock Assessment Report is organized into 2 sections. Section I – Introduction contains a brief description of the SEDAR Process, Assessment and Management Histories for the species of interest, and the management specifications requested by the Cooperator. Section II is the Assessment Process report. This section details the assessment model, as well as documents any data recommendations that arise for new data sets presented during this assessment process, or changes to data sets used previously.

The final Stock Assessment Reports (SAR) for Gulf of Mexico greater amberjack was disseminated to the public in November 2020. The Council’s Scientific and Statistical Committee (SSC) will review the SAR for its stock. The SSCs are tasked with recommending whether the assessments represent Best Available Science, whether the results presented in the SARs are useful for providing management advice and developing fishing level recommendations for the Council. An SSC may request additional analyses be conducted or may use the information provided in the SAR as the basis for their Fishing Level Recommendations (e.g., Overfishing Limit and Acceptable Biological Catch). The Gulf of Mexico Fishery Management Council’s SSC will review the assessment at its January 2021 meeting, followed by the Council receiving that information at its January 2021 meeting. Documentation on SSC recommendations are not part of the SEDAR process and are handled through each Council.

1 SEDAR PROCESS DESCRIPTION

SouthEast Data, Assessment, and Review (**SEDAR**) is a cooperative Fishery Management Council process initiated in 2002 to improve the quality and reliability of fishery stock assessments in the South Atlantic, Gulf of Mexico, and US Caribbean. SEDAR seeks improvements in the scientific quality of stock assessments and the relevance of information available to address fishery management issues. SEDAR emphasizes constituent and stakeholder

participation in assessment development, transparency in the assessment process, and a rigorous and independent scientific review of completed stock assessments.

SEDAR is managed by the Caribbean, Gulf of Mexico, and South Atlantic Regional Fishery Management Councils in coordination with NOAA Fisheries and the Atlantic and Gulf States Marine Fisheries Commissions. Oversight is provided by a Steering Committee composed of NOAA Fisheries representatives: Southeast Fisheries Science Center Director and the Southeast Regional Administrator; Regional Council representatives: Executive Directors and Chairs of the South Atlantic, Gulf of Mexico, and Caribbean Fishery Management Councils; a representative from the Highly Migratory Species Division of NOAA Fisheries, and Interstate Commission representatives: Executive Directors of the Atlantic States and Gulf States Marine Fisheries Commissions.

SEDAR is normally organized around two workshops and a series of webinars. First is the Data Workshop, during which fisheries, monitoring, and life history data are reviewed and compiled. The second stage is the Assessment Process, which is conducted via a workshop and/or a series of webinars, during which assessment models are developed and population parameters are estimated using the information provided from the Data Workshop. The final step is the Review Workshop, during which independent experts review the input data, assessment methods, and assessment products. The completed assessment, including the reports of all 3 stages and all supporting documentation, is then forwarded to the Council SSC for certification as ‘appropriate for management’ and development of specific management recommendations.

SEDAR workshops are public meetings organized by SEDAR staff and the lead Cooperator. Workshop participants are drawn from state and federal agencies, non-government organizations, Council members, Council advisors, and the fishing industry with a goal of including a broad range of disciplines and perspectives. All participants are expected to contribute to the process by preparing working papers, contributing, providing assessment analyses, and completing the workshop report.

2 MANAGEMENT OVERVIEW

2.1 Fishery Management Plan and Amendments

Original GMFMC FMP:

The Reef Fish Fishery Management Plan was implemented in November 1984. The regulations, designed to rebuild declining reef fish stocks, included: (1) prohibitions on the use of fish traps, roller trawls, and powerhead-equipped spear guns within an inshore stressed area; (2) a minimum size limit of 13 inches total length (TL) for red snapper with the exceptions that for-hire boats were exempted until 1987 and each angler could keep 5 undersize fish; and, (3) data reporting requirements.

GMFMC FMP Amendments affecting Greater Amberjack:

Description of Action	FMP/Amendment	Effective Date
Set a 28-inch fork length minimum size limit and 3 fish per person per day bag limit for recreational harvest of greater amberjack, with a 2-day possession limit allowed for qualified charter vessels and head boats on trips that extend beyond 24 hours, and a 36-inch fork length minimum size limit of greater amberjack for commercial harvest. Established a longline and buoy gear boundary and expanded the stressed area to the entire Gulf coast. Established a commercial reef fish permit.	Amendment 1	1990
Established a moratorium on the issuance of new reef fish permits for a maximum period of three years; established an allowance for permit transfers. Added Almaco jack and banded rudderfish to the fishery management unit.	Amendment 4	1992
Created an Alabama special management zone (SMZ) and a framework procedure for future specification of SMZs. Established restrictions on the use of fish traps in the Gulf of Mexico EEZ, and implemented a three-year moratorium on the use of fish traps by creating a fish trap endorsement. Required that finfish be landed head and tails intact	Amendment 5	1994
Established reef fish dealer permitting and record keeping.	Amendment 7	1994

Extended the reef fish permit moratorium through December 31, 1995 and allowed collections of commercial landings data for initial allocation of individual transferable quota (ITQ) shares. Established historical captain status for purposes of ITQ allocation.	Amendment 9	1994
Implemented a new commercial reef fish permit moratorium for no more than five years or until December 31, 2000, permitted dealers can only buy reef fish from permitted vessels and permitted vessels can only sell to permitted dealers, established a charter and headboat reef fish permit.	Amendment 11	1996
Reduced the greater amberjack bag limit from three fish to one fish per person, and created an aggregate bag limit of 20 reef fish for all reef fish species not having a bag limit.	Amendment 12	1997
Initiated a 10-year phase-out on the use of fish traps in the EEZ from February 7, 1997 to February 7, 2007, after which fish traps would be prohibited, and prohibited the use of fish traps west of Cape San Blas, Florida.	Amendment 14	1997
Commercial harvest of greater amberjack closed March, April and May of each year. Prohibited harvest of reef fish from traps other than permitted reef fish traps, stone crab traps, or spiny lobster traps.	Amendment 15	1998
(1) The possession of reef fish exhibiting the condition of trap rash on board any vessel with a reef fish permit that is fishing spiny lobster or stone crab traps is prima facie evidence of illegal trap use and is prohibited except for vessels possessing a valid fish trap endorsement; (2) that NOAA Fisheries establish a system design, implementation schedule, and protocol to require implementation of a vessel monitoring system (VMS) for vessels engaged in the fish trap fishery, with the cost of the vessel equipment, installation, and maintenance to be paid or arranged by the owners as appropriate; and, (3) that fish trap vessels	Amendment 16A	1998

<p>submit trip initiation and trip termination reports. Prior to implementing this additional reporting requirement, there will be a one-month fish trap inspection/compliance/education period, at a time determined by the NOAA Fisheries Regional Administrator and published in the <i>Federal Register</i>. During this window of opportunity, fish trap fishermen will be required to have an appointment with NMFS enforcement for the purpose of having their trap gear, permits, and vessels available for inspection. The disapproved measure was a proposal to prohibit fish traps south of 25.05 degrees north latitude beginning February 7, 2001. The status quo 10-year phase-out of fish traps in areas in the Gulf EEZ is therefore maintained.</p>		
<p>Set a slot limit for banded rudderfish and lesser amberjack of 14 inches to 22 inches FFL, and set an aggregate recreational bag limit of 5 fish for those species in aggregate. The purpose of these actions was to reduce harvest of juvenile greater amberjack that were misidentified as banded rudderfish or lesser amberjack.</p>	<p>Amendment 16B</p>	<p>1999</p>
<p>Extended the commercial reef fish permit moratorium for another five years, from its previous expiration date of December 31, 2000 to December 31, 2005</p>	<p>Amendment 17</p>	<p>2000</p>
<p>Prohibited vessels with commercial harvests of reef fish aboard from also retaining fish caught under recreational bag and possession limits. Vessels with both for-hire and commercial permits were limited to the minimum crew size outlined in its Certificate of Inspection when fishing commercially. Prohibited the use of reef fish other than sand perches for bait. Required commercially permitted reef fish vessels to be equipped with VMS.</p>	<p>Amendment 18A</p>	<p>2006</p>

Established two marine reserve areas off the Tortugas area and prohibits fishing for any species and anchoring by fishing vessels inside the two marine reserves.		
Established a 3-year moratorium on the issuance of new charter and headboat vessel permits in the recreational for hire fisheries in the Gulf EEZ. Allowed transfer of permits. Required vessel captains/owners to participate in data collection efforts.	Amendment 20	2002
Continues the Madison-Swanson and Steamboat Lumps marine reserves for an additional 6 years, until July 2010. Modified the fishing restrictions within the reserves to allow surface trolling during May – October.	Amendment 21	2004
Established bycatch reporting methodologies for the reef fish fishery.	Amendment 22	2005
Extended the commercial reef fish permit moratorium indefinitely. Established a permanent limited access system for the commercial fishery for Gulf reef fish. Permits issued under the limited access system are renewable and transferable.	Amendment 24	2005
Extended the recreational for-hire reef fish permit moratorium indefinitely. Established a limited access system on for-hire reef fish and CMP permits. Permits are renewable and transferable in the same manner as currently prescribed for such permits.	Amendment 25	2006
Require the use of non-stainless steel circle hooks when using natural baits to fish for Gulf reef fish, require the use of venting tools and de-hooking devices when participating in the commercial or recreational reef fish fisheries.	Amendment 27	2008

Maintain the three-year stepped rebuilding plan based on a constant F _{OY} projection as specified in Secretarial Amendment 2, and establish TAC at 1.9 mp for 2008 through 2010 and 3.5 mp from 2011 through 2012. Establish accountability measures that allow the Regional Administrator to close a sector when that sector's allocation of TAC has been	Amendment 30A	2008
--	---------------	------

<p>reached or projected to be reached. If recreational landings exceed the sector’s share of TAC, the RA will file a notice reducing the length of the recreational fishing season for the time necessary to recover the overage in the following fishing year. If commercial landings exceed the commercial quota, the Regional Administrator shall issue a notice reducing the commercial quota in the following year by the amount the quota was exceeded in the previous year. Increase the recreational minimum size limit for greater amberjack to 30-inches FL, and eliminate the bag limit for captain and crew. Establish commercial quotas for 2008 through 2010 of 503,000 pounds and for 2011 and 2012 of 938,000 pounds.</p>		
<p>Longline endorsement requirement - Vessels must have average annual reef fish landings of 40,000 pounds gutted weight or more from 1999 through 2007 The longline boundary in the eastern Gulf is extended from the 20-fathom depth contour to the 35-fathom depth contour from June - August. Vessels are limited to 1000 hooks of which no more than 750 of which can be rigged for fishing or fished.</p>	<p>Amendment 31</p>	<p>2010</p>
<p>Establishes a commercial trip limit of 2,000 pounds. Establishes an annual catch limit equal to the acceptable biological catch at 1,780,000 pounds. Establishes allocations and annual catch targets, which act as quotas for the commercial and recreational sectors. The commercial allocation is 27% and the recreational allocation is 73% of the allowable catch. Until a future stock assessment is completed, or the annual catch limit is exceeded, the commercial quota will be 409,000 pounds, and the recreational quota will be 1,130,000 pounds. The 2013 commercial quota will be reduced by the 2012 landing overage after those numbers have been finalized.</p>	<p>Amendment 35</p>	<p>2012</p>

<p>This amendment standardized the minimum stock size threshold (MSST) for certain reef fish species. MSST is used to determine whether or not a stock is considered to be overfished; if the biomass of the stock falls below MSST, then the stock is considered overfished. The MSST for greater amberjack, among other species, is equal to 50% of the biomass at maximum sustainable yield. As long as overfishing is prevented, the stock biomass should never drop below MSST.</p>	<p>Amendment 44</p>	<p>2017</p>
--	---------------------	-------------

Management and quota overage information from Amendment 30A to Amendment 35 for greater amberjack

Prior to Amendment 30A, there was not a specified allocation of the stock ACL for the recreational and commercial sectors. In Amendment 30A, the Council selected an interim allocation (73% recreational: 27% commercial) that would remain in effect until the Council, through the recommendations of an Ad Hoc Allocation Committee, could implement an amendment that fairly and equitably addressed the allocation of Greater Amberjack between the recreational and commercial sectors.

GMFMC Regulatory Amendments:

September 2010:

Provides a more specific definition of buoy gear by limiting the number of hooks, limiting the terminal end weight, restricting materials used for the line, restricting the length of the drop line, and where the hooks may be attached. In addition, the Council requested that each buoy must display the official number of the vessel (USCG documentation number or state registration number) to assist law enforcement in monitoring the use of the gear, which requires rulemaking.

January 2011:

Intended to avoid in-season quota closures during peak economic fishing months, maximize social and economic benefits, and potentially provide biological benefits by protecting the Greater Amberjack stock during the peak spawning period. This regulatory framework action modifies the existing Greater Amberjack recreational fishing season, creating a June 1 - July 31 closed

season. This closure coincides with the open recreational seasons for other managed reef fish species such as red snapper.

July 2015:

Decreased the total ACL from 1,780,000 pounds whole weight to 1,720,000 pounds whole weight; set the commercial ACL at 464,400 pounds whole weight and the commercial ACT at 394,740 pounds whole weight; set the recreational ACL at 1,255,600 pounds whole weight and the recreational ACT at 1,092,372 pounds whole weight; reduced the commercial trip limit from 2,000 pounds whole weight to 1,500 pounds gutted weight; and, increased the minimum recreational size limit from 30 inches fork length to 34 inches fork length. This final rule was effective January 4, 2016.

September 2017:

This amendment used the ACL/ACT Control Rule to establish a 13% buffer for the commercial sector and a 17% buffer to the recreational sector between the respective sector ACLs and ACTs. The greater amberjack ACLs and ACTs are as follows:

Year	ABC	Recreational		Commercial	
		ACL	ACT	ACL	ACT
2018	1,182,000	862,860	716,173	319,140	277,651
2019	1,489,000	1,086,970	902,185	402,030	349,766
2020	1,794,000	1,309,620	1,086,985	484,380	421,411

The amendment also created a recreational closed season from January 1 – June 30. This final rule was effective January 27, 2018.

November 2017:

Modified the recreational fishing year to begin on August 1 and run through July 31 of the following year. Also modified the recreational season so that it is closed from January 1 – April 30, June 1 -July 31, and November 1 – December 31. This final rule was effective April 30, 2018.

July 2019:

Reduced the commercial greater amberjack trip limit to 1000 pounds gutted weight. When 75% of the commercial ACT is harvested, the trip limit will be reduced to 250 pounds gutted weight. This final rule was effective May 14, 2020.

2.2 Emergency and Interim Rules**January 1, 2009:**

NOAA's National Marine Fisheries Service (NOAA Fisheries Service) has published a final rule implementing interim measures in the Gulf of Mexico reef fish fishery. The rule published in the Federal Register on December 2, 2008, and the measures are effective January 1, 2009. The Gulf of Mexico Fishery Management Council (Council) requested a temporary rule be effective at the beginning of 2009 to address overfishing of Gag, as well as Red Snapper, Greater Amberjack, and Gray Triggerfish until more permanent measures can be implemented through Amendment 30B to the Fishery Management Plan for the Reef Fish Resources of the Gulf of Mexico. The interim rule will, with respect to Greater Amberjack, require operators of federally permitted Gulf of Mexico commercial and for-hire reef fish vessels to comply with the more restrictive of federal or state reef fish regulations when fishing in state waters for Red Snapper, Greater Amberjack, Gray Triggerfish, and Gag.

2.3 Secretarial Amendments**Secretarial Amendment 2 (2003):**

Sets MSY, OY, MFMT, and MSST levels for Greater Amberjack that follow the Sustainable Fisheries Act, and it establishes a ten-year rebuilding plan for Greater Amberjack based on three-year intervals. No specific management measures were proposed in this amendment, since the Greater Amberjack harvest is currently within the TAC specified for the first three-year interval.

2.4 Control Date Notices

Control date notices are used to inform fishermen that a license limitation system or other method of limiting access to a particular fishery or fishing method is under consideration. If a

program to limit access is established, anyone not participating in the fishery or using the fishing method by the published control date may be ineligible for initial access to participate in the fishery or to use that fishing method. However, a person who does not receive an initial eligibility may be able to enter the fishery or fishing method after the limited access system is established by transfer of the eligibility from a current participant, provided the limited access system allows such transfer. Publication of a control date does not obligate the Council to use that date as an initial eligibility criteria. A different date could be used, and additional qualification criteria could be established. The announcement of a control date is primarily intended to discourage entry into the fishery or use of a particular gear based on economic speculation during the Council's deliberation on the issues. The following summarizes control dates that have been established for the Reef Fish FMP. A reference to the full *Federal Register* notice is included with each summary.

November 1, 1989:

Anyone entering the commercial reef fish fishery in the Gulf and South Atlantic after November 1, 1989, may not be assured of future access to the reef fish resource if a management regime is developed and implemented that limits the number of participants in the fishery [54 FR 46755].

November 18, 1998:

The Council is considering whether there is a need to impose additional management measures limiting entry into the recreational-for-hire (i.e., charter vessel and headboat) fisheries for reef fish and coastal migratory pelagic fish in the EEZ of the Gulf and, if there is a need, what management measures should be imposed. Possible measures include the establishment of a limited entry program to control participation or effort in the recreational-for-hire fisheries for reef fish and coastal migratory pelagic [63 FR 64031] (In Amendment 20 to the Reef Fish FMP, a qualifying date of March 29, 2001, was adopted).

July 12, 2000:

The Council is considering whether there is a need to limit participation by gear type in the commercial reef fish fisheries in the exclusive economic zone of the Gulf and, if there is a need, what management measures should be imposed to accomplish this. Possible measures include modifications to the existing limited entry program to control fishery participation, or effort,

based on gear type, such as a requirement for a gear endorsement on the commercial reef fish vessel permit for the appropriate gear.

Gear types which may be included are longlines, buoy gear, handlines, rod-and-reel, bandit gear, spear fishing gear, and powerheads used with spears [65 FR 42978].

October 15, 2004:

The Council is considering the establishment of an individual fishing quota program to control participation or effort in the commercial grouper fisheries of the Gulf. If an individual fishing quota program is established, the Council is considering October 15, 2004, as a possible control date regarding the eligibility of catch histories in the commercial grouper fishery [69 FR 67106].

December 31, 2008:

The Council voted to establish a control date for all Gulf commercial reef fish vessel permits. The control date will allow the Council to evaluate fishery participation and address any level of overcapacity. The establishment of this control date does not commit the Council or NOAA Fisheries Service to any particular management regime or criteria for entry into this fishery. Fishermen would not be guaranteed future participation in the fishery regardless of their entry date or intensity of participation in the fishery before or after the control date under consideration. Comments were requested by close of business April 17, 2009 [74 FR 11517].

2.5 General Management Specifications

Table 2.5.1. General Information

Species	Greater Amberjack
Management Unit Definition	Gulf of Mexico EEZ
Management Entity	Gulf of Mexico Fishery Management Council
Management Contacts SERO / Council	Ryan Rindone – GMFMC Peter Hood – SERO
Current stock exploitation status	Overfished, undergoing overfishing (2016)
Current stock biomass status	3.616 million pounds, whole weight (2016 SEDAR 33 Update, using data through 2014)

Table 2.5.2. Specific Management Criteria

Criteria	Gulf of Mexico - Current (2016)		Gulf of Mexico - Proposed	
	Definition	Value	Definition	Value
MSST	$(1-M)^*B_{MSY}$	9.026 mp ww	$0.5*B_{MSY}$	SEDAR 70
MFMT	$F_{30\%SPR}$	0.2	F_{MSY}	SEDAR 70
MSY	$F_{30\%SPR}$	0.2	F_{MSY}	SEDAR 70
F_{MSY}	$F_{30\%SPR}$	0.2	SEDAR 70	SEDAR 70
OY	Equilibrium Yield @ F_{OY}	2020: 2.167 mp ww	Equilibrium Yield @ F_{OY}	SEDAR 70
F_{OY}	75% of F_{MSY}	0.15	$F_{OY} = 65\%, 75\%, 85\% F_{MSY}$	SEDAR 70
M	n/a	0.28	M	SEDAR 70

NOTE: “Proposed” columns are for indicating any definitions that may exist in FMPs or amendments that are currently under development and should therefore be evaluated in the current assessment. “Current” is those definitions in place now. Please clarify whether landings parameters are ‘landings’ or ‘catch’ (Landings + Discard). If ‘landings’, please indicate how discards are addressed.

Note: mp = million pounds; ww = whole weight.

Criteria	Current: SEDAR 33 Update (2016)		Proposed: SEDAR 70 (2020)	
	Definition	Value	Definition	Value
MSST	$(1-M)*SSB_{30\%SPR}$ M=0.28	9.026 mp ww	$0.5*B_{MSY}$	SEDAR 70
MFMT	F_{MSY}	0.2	F_{MSY} or proxy from the most recent stock assessment (median from probabilistic analysis)	SEDAR 70
MSY	F_{MSY}	0.2	Yield at F_{MSY} , landings and discards, pounds and numbers (median from probabilistic analysis)	SEDAR 70
F_{MSY}	$F_{30\%SPR}$	0.2	F_{MSY} or proxy	SEDAR 70
SSB_{MSY}^1	Equilibrium SSB @ F_{MSY}	12.535 mp ww	Spawning stock biomass (median from probabilistic analysis)	SEDAR 70
F Targets (i.e., F_{OY})	75% of F_{MSY}	0.15	75% F_{MSY}	SEDAR 70
Yield at F_{Target} (Equilibrium: 2020)	Equilibrium Yield @ F_{OY}	1.794 mp ww (2020)	landings and discards, pounds and numbers	SEDAR 70
M	Natural mortality, average across ages	0.28	Natural mortality, average across ages	SEDAR 70
Terminal F	Geometric mean of most recent three years of F	0.33	Geometric mean of most recent three years of F	SEDAR 70
Terminal Biomass ¹	SSB_{2016}	3.616 mp ww	$SSB_{Current}$	SEDAR 70
Exploitation Status	$F_{Current}/MFMT$	1.69	$F_{Current}/MFMT$	SEDAR 70
Biomass Status ¹	$SSB_{Current}/MSST$	0.40	$SSB_{Current}/MSST$ $SSB_{Current}/SSB_{MSY}$	SEDAR 70

Stock Rebuilding Information

The Greater Amberjack update assessment was completed and reviewed by the Scientific and Statistical Committee (SSC) at their March 2011 meeting. At that meeting, the SSC moved that the Southeast Data, Assessment, and Review (SEDAR) update assessment for Greater Amberjack (SEDAR 9 Update 2010) was the best scientific information available; however, they did not accept it as adequate for management. In addition, the yield projections were considered unreliable because they showed large sensitivity to small changes in initial conditions, fishing mortality rates, and catch. The SSC next focused on whether the assessment results were sufficient for setting

acceptable biological catch (ABC) under the control rule. Both Tier 1 and Tier 2 of the ABC control rule, which was developed by the SSC, require stable yield projections. Therefore, the SSC decided to use Tier 3b from the ABC control rule, in which the ABC is based on the most recent year’s landings, for setting the Greater Amberjack overfishing limit (OFL) and ABC (GMFMC 2012).

Gulf of Mexico Greater Amberjack are managed under the Fishery Management Plan for the Reef Fish Resources of the Gulf of Mexico (FMP). On November 13, 2012, NMFS issued a final rule to implement Amendment 35 to the FMP. Amendment 35 established a Greater Amberjack commercial annual catch limit (ACL) of 481,000 pounds (lb), an annual catch target (ACT) (equal to the commercial quota) of 409,000 lb, and a 2,000-lb commercial trip limit for Greater Amberjack. Accountability measures for Greater Amberjack allow for in-season closures of the commercial sector when the applicable ACT is reached or projected to be reached. If despite such closure, landings exceed the ACT, NMFS will reduce the ACT and ACL the following year by the amount of the overage from the prior fishing year. Reducing the stock ACL by 18% from no action is expected to end overfishing; whether overfishing has ended will remain unknown until completion of the next benchmark assessment, scheduled in 2013.

Table 2.5.3. General projection information

First Year of Management	2022 Fishing Year
Interim basis	- ACL, if ACL is met - Average exploitation, if ACL is not met
Projection Outputs	By fishing year
Landings	pounds and numbers
Discards	pounds and numbers
Exploitation	F & Probability $F > MFMT$
Biomass (total or SSB, as appropriate)	SSB & Probability $SSB > MSST$ (and Prob. $SSB > SSB_{MSY}$ if under rebuilding plan)
Recruits	Number

Table 2.5.4. Base Run Projections Specifications. Long Term and Equilibrium conditions.

Criteria	Definition	If overfished	If overfishing	Not overfished, no overfishing
Projection Span	Years	$T_{Rebuild}$	10	10
Projection Values	$F_{Current}$	X	X	X
	F_{MSY} (proxy)	X	X	X
	75% F_{MSY}	X	X	X
	$F_{Rebuild}$	X		
	$F=0$	X		

NOTE: Exploitation rates for projections may be based on point estimates from the base run (current process) or the median of such values from the MCBS evaluation of uncertainty. The objective is for projections to be based on the same criteria as the management specifications.

Table 2.5.5. P-Star Projections. Short term specifications for OFL and ABC recommendations. Additional P-star projections may be requested by the SSC once the ABC control rule is applied.

Criteria		Overfished	Not overfished
Projection Span	Years	10	10
Probability Values	50%	Probability of stock rebuild	Probability of overfishing

The following should be provided regardless of whether the stock is healthy or overfished:

- OFL: yield at F_{MSY} (or $F_{30\% SPR}$ proxy)
- OY: yield at 75% for $F_{30\% SPR}$
- Equilibrium MSY and equilibrium OY

If the stock is overfished, the following should also be provided:

- $F_{REBUILD}$ and the yield at $F_{REBUILD}$ (where the rebuilding time frame is 10 years)
- A probability distribution function (PDF) that can be used along with the P^* selected by the SSC to determine ABC. If multiple model runs are provided, this may need to wait until the SSC selects which model run to use for management.

The SSC typically recommends OFL and ABC yield streams for 3-5 years out. Yield streams provided by assessment scientists should:

- Go beyond five years
- Include constant catch scenarios for three and five years
- If a 10-year rebuilding plan is needed, yield streams should be provided for 10 years

Table 2.5.6. Quota Calculation Details

Note: mp = million pounds; ww = whole weight. ACT = annual catch target.

Current Stock ACL (2020)	1.794 mp ww
Next Scheduled Quota Change	-
Annual or averaged quota?	Annual
Does the quota include bycatch/discard?	No- Landed only

Quotas are conditioned upon exploitation. Bycatch/discard estimates are considered in setting the quota; however, quota values are for landed fish only.

2.6. Management and Regulatory Timeline

Table 2.6.1. Pertinent Federal Management Regulations

Harvest Restrictions – Trip Limits

*Trip limits do not apply during closures (if season is closed, then trip limit is zero.)

First Yr In Effect	Effective Date	End Date	Fishery	Bag Limit Per Person/Day	Bag Limit Per Boat/Day	Region Affected	FR Reference	FB	Amendment Number or Rule Type
1990	2/21/90	1/14/97	Rec	3	NA	Gulf of Mexico EEZ	55 FR 2078		Reef Fish Amendment 1
1997	1/15/97	Ongoing	Rec	1	NA	Gulf of Mexico EEZ	61 FR 65983		Reef Fish Amendment 12
2012	12/13/12	1/3/16	Com	NA	2000 lbs ww	Gulf of Mexico EEZ	77 FR 67574	FB12-091	Reef Fish Amendment 35
2016	1/4/16	Ongoing	Com	NA	1560 lbs ww; 1500 gw	Gulf of Mexico EEZ	80 FR 75433	FB15-089	RF 2015 Regulatory Amendment

Harvest Restrictions - Size Limits*

*Size limits do not apply during closures

First Yr In Effect	Effective Date	End Date	Fishery	Size Limit	Length Type	Region Affected	FR Reference	FB	Amendment Number or Rule Type
1990	2/21/90	8/3/08	Rec	28"	FL	Gulf of Mexico EEZ	55 FR 2078		Reef Fish Amendment 1
1990	2/21/90	Ongoing	Com	36"	FL	Gulf of Mexico EEZ	55 FR 2078		Reef Fish Amendment 1
2008	8/4/08	1/3/16	Rec	30"	FL	Gulf of Mexico EEZ	73 FR 38139	FB08-040	Reef Fish Amendment 30A
2016	1/4/16	Ongoing	Rec	34"	FL	Gulf of Mexico EEZ	80 FR 75433	FB15-089	RF 2015 Regulatory Amendment

Harvest Restrictions – Fishery Closures*

*Area specific regulations are documented under spatial restrictions

First Yr In Effect	Effective Date	End Date	Fishery	Closure Type	First Day Closed	Last Day Closed	Region Affected	FR Reference	Amendment Number or Rule Type
1998	1/29/98	Ongoing	Com	Seasonal	1-Mar	31-May	Gulf of Mexico EEZ	62 FR 67714	Reef Fish Amendment 15
2009	10/24/09	12/31/09	Rec	Quota	10/24/09	12/31/09	Gulf of Mexico EEZ	74 FR 54489	FB09-055
2009	11/7/09	12/31/09	Com	Quota	11/7/09	12/31/09	Gulf of Mexico EEZ	74 FR 57261	FB09-060
2010	10/28/10	12/31/10	Com	Quota	10/28/10	12/31/10	Gulf of Mexico EEZ	75 FR 64171; 75 FR 35335	FB10-092; FB10-058
2011	5/31/11	4/30/18	Rec	Seasonal	1-Jun	31-Jul	Gulf of Mexico EEZ	76 FR 23904	RF 2011 Regulatory Amendment
2011	6/18/11	8/30/11	Com	Quota	18-Jun	30-Aug	Gulf of Mexico EEZ	76 FR23909; 76 FR 51905	FB12-021; FB11-041; FB11-062
2011	10/20/11	12/31/11	Com	Quota	10/20/11	12/31/11	Gulf of Mexico EEZ	76 FR 64248; 76 FR23909; 76 FR 51905	FB11-082; FB12-021; FB11-041; FB11-062
2012	4/2/12	12/31/12	Com	Quota	4/2/12	12/31/12	Gulf of Mexico EEZ	77 FR 19563	FB12-021
2013	7/1/13	12/31/13	Com	Quota	7/1/13	12/31/13	Gulf of Mexico EEZ	78 FR 37148	FB13-055
2014	8/25/14	12/31/14	Both	Quota	8/24/04	12/31/14	Gulf of Mexico EEZ	79 FR 48095	FB14-059
2015	7/19/15	12/31/15	Com	Quota	7/19/15	12/31/15	Gulf of Mexico EEZ	80 FR 39715	FB15-048
2015	9/28/15	12/31/15	Rec	Quota	9/28/15	12/31/15	Gulf of Mexico EEZ	80 FR 56930	FB15-069
2016	7/17/16	12/31/16	Com	Quota	7/17/16	12/31/16	Gulf of Mexico EEZ	81 FR 45068	FB16-045
2016	6/1/16	12/31/16	Rec	Quota	6/1/16	12/31/16	Gulf of Mexico EEZ	81 FR 48719	FB16-032
2017	6/20/17	12/31/17	Com	Quota	6/20/17	12/31/17	Gulf of Mexico EEZ	82 FR 28013	FB17-033
2017	3/24/17	12/31/17	Rec	Quota	3/24/17	12/31/17	Gulf of Mexico EEZ	82 FR 14477	FB17-016
2018	4/3/18	12/31/19	Com	Quota	4/3/18	12/31/19	Gulf of Mexico EEZ	83 FR 14202	FB18-022
2018	1/27/18	4/29/18	Rec	Seasonal	1/27/18	4/30/18	Gulf of Mexico EEZ	82 FR 61485	GAJ #1; FB17-080; FB17-082
2017/2018	4/30/18	Ongoing	Rec	Seasonal	Nov. 1 - Apr. 30 and Jun. 1 - Jul. 31		Gulf of Mexico EEZ	83 FR 13426	GAJ #2; FB18-008
2018/2019	5/1/19	7/31/19	Rec	Quota	5/1/19	7/31/19	Gulf of Mexico EEZ	84 FR 10995	FB19-016
2019	6/9/19	12/31/19	Com	Quota	6/9/19	12/31/19	Gulf of Mexico EEZ	84 FR 22073	FB19-025

Harvest Restrictions - Seasons

First Yr In Effect	Effective Date	End Date	Fishery	Closed	Region Affected	FR Reference	FB	Amendment Number or Rule Type
1998	1/29/98	Ongoing	Com	March 1 - May 31	Gulf of Mexico EEZ	62 FR 67714		Reef Fish Amendment 15
2011	5/31/11	1/26/18	Rec	June 1 - July 31	Gulf of Mexico EEZ	76 FR 23904	FB11-040	RF 2011 Regulatory Amendment
2018	1/27/18	4/29/18	Rec	January 1 - June 30	Gulf of Mexico EEZ	82 FR 61485	FB17-080	GAJ #1 Framework
2018	4/30/18	Ongoing	Rec	November 1 - April 30 and June 1 - July 31	Gulf of Mexico EEZ	83 FR 13426	FB18-021	GAJ #2 Framework

Harvest Restrictions – Fishing Year

First Yr In Effect	Effective Date	End Date	Fishery	Fishing Year	Region Affected	FR Reference	FB	Amendment Number or Rule Type
1984	11/8/84	Ongoing	Com	January 1 - December 31	Gulf of Mexico EEZ	49 FR 39548		Original FMP
1984	11/8/84	4/29/18	Rec	January 1 - December 31	Gulf of Mexico EEZ	49 FR 39548		Original FMP
2018	4/30/18	Ongoing	Rec	August 1 - July 31	Gulf of Mexico EEZ	83 FR 13426	FB18-021	GAJ #2 Framework

Harvest Restrictions – Spatial Restrictions

Area	First Yr In Effect	Effective Date	End Date	Fishery	First Day Closed	Last Day Closed	Restriction in Area	FR Reference	Amendment Number or Rule Type
Gulf of Mexico Stressed Areas	1984	11/8/84	Ongoing	Both	Year round		Prohibited powerheads for Reef FMP	49 FR 39548	Original Reef Fish FMP
	1984	11/8/84	Ongoing	Both	Year round		Prohibited pots and traps for Reef FMP	49 FR 39548	Original Reef Fish FMP
Alabama Special Management Zones	1994	2/7/94	Ongoing	Both	Year round		Allow only hook-and line gear with 3 or less hooks per line) and spearfishing for Reef FMP	59 FR 966	Reef Fish Amendment 5
EEZ, inside 50 fathoms west of Cape San Blas, FL	1990	2/21/90	Ongoing	Both	Year round		Prohibited longline and buoy gear for Reef FMP	55 FR 2078	Reef Fish Amendment 1
EEZ, inside 20 fathoms east of Cape San Blas, FL	1990	2/21/90	4/17/09	Both	Year round		Prohibited longline and buoy gear for Reef FMP	55 FR 2078	Reef Fish Amendment 1
EEZ, inside 50 fathoms east of Cape San Blas, FL	2009	4/18/09	10/15/09	Both	18-Apr	28-Oct	Prohibited bottom longline for Reef FMP	74 FR 20229	Emergency Rule
EEZ, inside 35 fathoms east of Cape San Blas, FL	2009	10/16/09	4/25/10	Both	Year round		Prohibited bottom longline for Reef FMP	74 FR 53889	Sea Turtle ESA Rule
	2010	4/26/10	Ongoing	Rec	Year round		Prohibited bottom longline for Reef FMP	75 FR 21512	Reef Fish Amendment 31
	2010	4/26/10	Ongoing	Com	1-Jun	31-Aug	Prohibited bottom longline for Reef FMP	75 FR 21512	Reef Fish Amendment 31
Madison-Swanson	2000	4/19/00	6/2/04	Both	Year round		Fishing prohibited except HMS ¹	65 FR 31827	Reef Fish Regulatory Amendment
	2004	6/3/04	Ongoing	Both	1-May	31-Oct	Fishing prohibited except surface trolling	70 FR 24532 74 FR 17603	Reef Fish Amendment 21 Reef Fish Amendment 30B
	2004	6/3/04	Ongoing	Both	1-Nov	30-Apr	Fishing prohibited	70 FR 24532 74 FR 17603	Reef Fish Amendment 21 Reef Fish Amendment 30B
Steamboat Lumps	2000	4/19/00	6/2/04	Both	Year round		Fishing prohibited except HMS ¹	65 FR 31827	Reef Fish Regulatory Amendment
	2004	6/3/04	Ongoing	Both	1-May	31-Oct	Fishing prohibited except surface trolling	70 FR 24532 74 FR 17603	Reef Fish Amendment 21 Reef Fish Amendment 30B
	2004	6/3/04	Ongoing	Both	1-Nov	30-Apr	Fishing prohibited	70 FR 24532 74 FR 17603	Reef Fish Amendment 21 Reef Fish Amendment 30B
The Edges	2010	7/24/09	Ongoing	Both	1-Jan	30-Apr	Fishing prohibited	74 FR 30001	Reef Fish Amendment 30B Supplement
20 Fathom Break	2014	7/5/13	Ongoing	Rec	1-Feb	31-Mar	Fishing for SWG prohibited ²	78 FR 33259	Reef Fish Framework Action
Flower Garden	1992	1/17/92	Ongoing	Both	Year round		Fishing with bottom gears prohibited ³	56 FR 63634	Sanctuary Designation
Riley's Hump	1994	2/7/94	8/18/02	Both	1-May	30-Jun	Fishing prohibited	59 FR 966	Reef Fish Amendment 5
Tortugas Reserves	2002	8/19/02	Ongoing	Both	Year round		Fishing prohibited	67 FR 47467	Tortugas Amendment
Pulley Ridge	2006	1/23/06	Ongoing	Both	Year round		Fishing with bottom gears prohibited ³	70 FR 76216	Essential Fish Habitat (EFH) Amendment

¹HMS: highly migratory species (tuna species, marlin, oceanic sharks, sailfishes, and swordfish)

²SWG: shallow-water grouper (black, gag, red, red hind, rock hind, scamp, yellowfin, and yellowmouth)

³Bottom gears: Bottom longline, bottom trawl, buoy gear, pot, or trap

Harvest Restrictions – Gears*

*Area specific gear regulations are documented under spatial restrictions

Gear Type	First Year In Effect	Effective Date	End Date	Gear/Harvesting Restriction	Region Affected	FR Reference	Amendment Number or Rule Type
Poison	1984	11/8/84	Ongoing	Prohibited for Reef FMP	Gulf of Mexico EEZ	49 FR 39548	Original Reef Fish FMP
Explosives	1984	11/8/84	Ongoing	Prohibited for Reef FMP	Gulf of Mexico EEZ	49 FR 39548	Original Reef Fish FMP
Pots and Traps	1984	11/23/84	2/3/94	Established fish trap permit	Gulf of Mexico EEZ	50 FR 39548	Original Reef Fish FMP
	1984	11/23/84	2/20/90	Set max number of traps fish by a vessel at 200	Gulf of Mexico EEZ	50 FR 39548	Original Reef Fish FMP
	1990	2/21/90	2/3/94	Set max number of traps fish by a vessel at 100	Gulf of Mexico EEZ	55 FR 2078	Reef Fish Amendment 1
	1994	2/4/94	2/7/97	Moratorium on additional commercial trap permits	Gulf of Mexico EEZ	59 FR 966	Reef Fish Amendment 5
	1997	3/25/97	2/6/07	Phase out of fish traps begins	Gulf of Mexico EEZ	62 FR 13983	Reef Fish Amendment 14
	1997	12/30/97	2/6/07	Prohibited harvest of reef fish from traps other than permitted reef fish, stone crab, or spiny lobster traps.	Gulf of Mexico EEZ	62 FR 67714	Reef Fish Amendment 15
All	2007	2/7/07	Ongoing	Traps prohibited	Gulf of Mexico EEZ	62 FR 13983	Reef Fish Amendment 14
	1992	4/8/92	12/31/95	Moratorium on commercial permits for Reef FMP	Gulf of Mexico EEZ	68 FR 11914 59 FR 39301	Reef Fish Amendment 4 Reef Fish Amendment 9
	1994	2/7/94	Ongoing	Finfish must have head and fins intact through landing, can be eviscerated, gilled, and scaled but must otherwise be whole (HMS and bait exceptions)	Gulf of Mexico EEZ	59 FR 39301	Reef Fish Amendment 9
	1996	6/1/96	12/31/05	Moratorium on commercial permits for Gulf reef fish.	Gulf of Mexico EEZ	61 FR 34930 65 FR 41016	Interim Rule Reef Fish Amendment 17
	2006	9/8/06	Ongoing	Use of Gulf reef fish as bait prohibited. ¹	Gulf of Mexico EEZ	71 FR 45428	Reef Fish Amendment 18A
Vertical Line	2008	6/1/08	Ongoing	Requires non-stainless steel circle hooks and dehooking devices	Gulf of Mexico EEZ	74 FR 5117	Reef Fish Amendment 27
	2008	6/1/08	9/3/13	Requires venting tools	Gulf of Mexico EEZ	74 FR 5117 78 FR 46820	Reef Fish Amendment 27 Framework Action

Quota Information - Recreational

First Yr In Effect	Last YR In Effect	Effective Date	End Date	Payback ACT	Actual ACT	Payback ACL	Actual ACL	Units	Region Affected	FR Reference	FB	Amendment Number or Rule Type
2010	2010	1/1/10	6/21/10			None	1,368,000	ww	Gulf of Mexico EEZ	73 FR 38139	FB08-040	RF 30A; effective 8.4.08
2010	2010	6/22/10	12/31/10			1,243,184	1,368,000	ww	Gulf of Mexico EEZ	75 FR 35335	FB10-058; FB10-085	
2011	2011	1/1/11	4/28/11		None	None	1,368,000	ww	Gulf of Mexico EEZ			
2011	2011	4/29/11	12/31/11	None		1,315,224	1,368,000	ww	Gulf of Mexico EEZ	76 FR 23910	FB11-041	
2012	2012	1/1/12	12/12/12			None	1,368,000	ww	Gulf of Mexico EEZ			
2012	2012	12/13/12	12/31/12		1,130,000	None	1,299,000	ww	Gulf of Mexico EEZ	77 FR 67574	FB12-091	RF 35; effective 12.13.12
2013	2013	1/1/13	12/31/13		1,130,000	None	1,299,000	ww	Gulf of Mexico EEZ			
2014	2014	1/1/14	4/22/14		1,130,000	None	1,299,000	ww	Gulf of Mexico EEZ			
2014	2014	4/23/14	8/24/14	862,512	1,130,000	1,031,512	1,299,000	ww	Gulf of Mexico EEZ	79 FR 22594		
2014	2014	8/25/14	12/31/14	888,829	1,130,000	1,057,829	1,299,000	ww	Gulf of Mexico EEZ	79 FR 48095	FB14-059	
2015	2015	1/1/15	12/31/15	None	1,130,000	None	1,299,000	ww	Gulf of Mexico EEZ			
2016	2016	1/4/16	12/31/16	1,034,442	1,092,372	1,197,670	1,255,600	ww	Gulf of Mexico EEZ	80 FR 75433; 81 FR 48719	FB15-089	2015 Framework; effective 1.4.16
2017	2017	1/1/17	3/23/17	None	1,092,372	None	1,255,600	ww	Gulf of Mexico EEZ			
2017	2017	3/24/17	12/31/17	335,741	1,092,372	498,969	1,255,600	ww	Gulf of Mexico EEZ	82 FR 14477	FB17-016	
2018	2018	1/1/18	1/26/18	None	1,092,372	None	1,255,600	ww	Gulf of Mexico EEZ			
2018	2018	1/1/2018 (date landings were attributed to new ACL)	7/31/18	None	716,173	None	862,860	ww	Gulf of Mexico EEZ	82 FR 61485	FB17-080; FB17-082	GAJ #1 Framework; effective 1.27.18
2018	2019	8/1/18	7/31/19	None	902,185	None	1,086,970	ww	Gulf of Mexico EEZ			
2019	2020	8/1/19	7/31/20	None	1,086,985	None	1,309,620	ww	Gulf of Mexico EEZ			

Quota Information – Commercial

First Yr In Effect	Last YR In Effect	Effective Date	End Date	Payback ACT	Actual ACT	Payback ACL	Actual ACL	Units	Region Affected	FR Reference	FB	Amendment Number or Rule Type
2008	2008	1/1/08	8/3/08				TAC	ww	Gulf of Mexico EEZ			
2008	2008	8/4/08	12/31/08			None	503,000	ww	Gulf of Mexico EEZ	73 FR 38139	FB08-040	RF 30A; effective 8.4.08
2009	2009	1/1/09	12/31/09				503,000	ww	Gulf of Mexico EEZ			
2010	2010	1/1/10	6/21/10				503,000	ww	Gulf of Mexico EEZ			
2010	2010	6/22/10	12/31/10			373,072	503,000	ww	Gulf of Mexico EEZ	75 FR 35335	FB10-058	
2011	2011	1/1/11	4/28/11	None	None	None	503,000	ww	Gulf of Mexico EEZ			
2011	2011	4/29/11	8/18/11			313,900	503,000	ww	Gulf of Mexico EEZ	76 FR 23909	FB11-041	
2011	2011	8/19/11	12/31/11			342,091	503,000	ww	Gulf of Mexico EEZ	76 FR 51905	FB11-062	
2012	2012	1/1/12	4/1/12				503,000	ww	Gulf of Mexico EEZ			
2012	2012	4/2/12	12/12/12			237,438	503,000	ww	Gulf of Mexico EEZ	77 FR 19563	FB12-021	
2012	2012	12/13/12	12/31/12		409,000	237,438	481,000	ww	Gulf of Mexico EEZ	77 FR 67574	FB12-091	RF 35; effective 12.13.12
2013	2013	1/1/13	2/26/13		409,000	None	481,000	ww	Gulf of Mexico EEZ			
2013	2013	2/27/13	12/31/13	338,157	409,000	410,157	481,000	ww	Gulf of Mexico EEZ	78 FR 13284	FB13-055	
2014	2014	1/1/14	12/31/14	None	409,000	None	481,000	ww	Gulf of Mexico EEZ			
2015	2015	1/1/15	12/31/15	None	409,000	None	481,000	ww	Gulf of Mexico EEZ			
2016	2016	1/4/16	12/31/16	None	394,740	None	464,400	ww	Gulf of Mexico EEZ	80 FR 75433	FB15-089	2015 Framework; effective 1.4.16
2017	2017	1/1/17	12/31/17	None	394,740	None	464,400	ww	Gulf of Mexico EEZ			
2018	2018	1/1/18	12/31/18	None	277,651	None	319,140	ww	Gulf of Mexico EEZ	82 FR 61485	FB17-080; FB17-082	GAJ #1 Framework; effective 1.27.18
2019	2019	1/1/19	6/8/19	None	349,766	None	402,030	ww	Gulf of Mexico EEZ			
2019	2019	6/9/19	12/31/19	337,503	349,766	389,767	402,030	ww	Gulf of Mexico EEZ	84 FR 22073	FB19-025	

3 ASSESSMENT HISTORY AND REVIEW

Greater Amberjack, Lesser Amberjack, Banded Rudderfish, and Almaco Jack were added to the Gulf of Mexico Reef Fish Fishery Management Plan (FMP) [55 FR 2079] in 1989, following an explosive rise in the reported landings of amberjack species in the mid-1980s.

In 1993, a weight based population model was applied (Simple Likelihood Method –SLM, Parrack 1990, 1992, 1996) to investigate the exploitation status of Greater Amberjack through 1991 (Cumming-Parrack 1993). In 1996, an age based virtual population analysis (VPA) was applied by McClellan and Cummings (1996) using the ADAPT method (Gavaris 1988, Powers and Restrepo 1991) to assess the status of the resource through 1995. Turner et al. (2000) applied a VPA using the VPA-2box procedure (Porch 1999) in 2000 to assess the status through 1998.

Following Turner et al. assessment of 2000, a rebuilding plan was established in 2003 under Secretarial Amendment 2 to the Gulf of Mexico Reef Fish FMP [68 FR 39898]. The biological reference points and status criteria at equilibrium were defined as Maximum Sustainable Yield (MSY) = $F_{30\%SPR}$ and an Optimum Yield (OY) = $F_{40\%SPR}$. The Maximum Fishing Mortality Threshold (MFMT) was defined as $F_{30\%SPR}$ and the Minimum Spawning Stock Threshold (MSST) was defined as $(1-M)*BMSY$ with natural mortality (M) equal to 0.24. A proxy for FMSY was defined as $F_{30\%SPR}$ for Greater Amberjack because biomass-based estimates were considered less accurate than SPR-based estimates in the 2000 assessment.

In 2006 under SEDAR 9, a benchmark stock assessment for Gulf of Mexico Greater Amberjack was conducted under the Southeast Data Assessment and Review Process (SEDAR, <http://safmc.net/science-and-statistics/sedar-stock-assessment-program>). For the 2006 stock evaluation, three assessment models were considered (SEDAR, 2006) including: (1) a VPA using the same procedure as in the 2000 evaluation (VPA 2-box (Porch 1999)), (2) a non-equilibrium surplus production model (ASPIC), and (3) a State-Space Age-Structured Production Model (SSASPM, Porch 2002). The VPA was presented for continuity with the 2000 stock assessment (Turner et al. 2000). ASPIC and SSASPM were presented because these models have less rigid assumptions on life history inputs including knowing the age structure of the catch explicitly; the latter assumption had been raised as a concern in using the VPA. The SEDAR 9

AW recommended the ASPIC production model as the final preferred model selected for the assessment of the stock status using data through 2004 (SEDAR, 2006). In 2010, an update assessment was conducted using the ASPIC model (SEDAR 2011) using data through 2009.

Following the SEDAR 9 benchmark assessment and the SEDAR 9 Update assessment, changes were made to the rebuilding plan for Greater Amberjack. In 2008, Amendment 30A to the Reef Fish FMP readjusted the Annual Catch Limits (ACL), established accountability measures and established separate quota allocations for the commercial and recreational sectors (73% recreational and 27% commercial) [73 FR 38139]. Amendment 30A also increased the recreational size limit from 28 to 30 inches fork length and implemented a zero bag limit for captain and crew of for-hire vessels. In 2011, Amendment 35 modified the ACL based on the landings in recent years and established a commercial trip limit [77 FR 67574].

In 2013, a benchmark stock assessment was conducted for the Gulf of Mexico Greater Amberjack (SEDAR 33). Two population models were presented in the SEDAR 33 assessment. They were the statistical catch at age model, Stock Synthesis (SS) version SS3.24_S_07/24/2013, and the ASPIC production model. SS was the primary assessment model selected for the current stock evaluation using data through 2012. ASPIC models were presented under continuity conditions as well as under additional exploratory conditions.

In 2015, the SEDAR 33 Update stock assessment was conducted for the Gulf of Mexico Greater Amberjack (SEDAR 33). The recommended model from the SEDAR 33 benchmark assessment, Stock Synthesis (SS3.24_S) was the model applied for the Update assessment. The Update evaluation considered all removals, size compositions, CPUE indices from dependent and independent sources through the 2015 terminal year. As in the SEDAR 9 benchmark, assessment stock status was calculated. The biological reference points and status criteria at equilibrium were defined as Maximum Sustainable Yield (MSY) = $F_{30\%SPR}$ and an Optimum Yield (OY) = $F_{40\%SPR}$. The Maximum Fishing Mortality Threshold (MFMT) was defined as $F_{30\%SPR}$ and the Minimum Spawning Stock Threshold (MSST) was defined as $(1-M)*BMSY$ with natural mortality (M) equal to 0.28. A proxy for FMSY was defined as $F_{30\%SPR}$ for Greater

Amberjack because biomass-based estimates were considered less accurate than SPR-based estimates in the 2000 assessment.

References:

- Gavaris, S. 1988. An adaptive framework for the estimation of population size. Can. J. Fish. Sci. Adv. Comm. (CAFSAC) Res. Doc. 88/29, 12p.
- McClellan, D.B, and N.J. Cummings. 1996. Stock assessment of Gulf of Mexico Greater Amberjack through 1995. U.S. Dept. of Comm., NOAA, NMFS, SEFSC, Miami Lab. Contr. No. MIA-96/97-03.70p.
- Parrack (1990). A study of shark exploitation in U.S. Atlantic coastal waters during 1986-1989. DOC, NOAA, NMFS, SEFSC Miami Laboratory Contribution No. MIA-90/91-03. 14p.
- Parrack, M. 1992. Report of the Atlantic coastal shark fishery analysis review, September 30, 1992. Final report to NOAA NMFS, Miami Laboratory (also occurs as Appendix II in NMFS 1993).
- Parrack, M. 1996. A simple likelihood method of estimating fish abundance. 1996 NMFS Stock Evaluation Workshop document SB-II-14:22 pp. NMFS Southeast Fish. Sci. Ctr, Miami, FL.
- Parrack, N.C. 1993. The exploitation status of Atlantic amberjack fisheries through 1991. U.S. Dept. of Com., NOAA, NMFS, SEFSC, Miami Laboratory Cont. No. MIA-92.93-30. 98p.
- Porch, C.E. 2002. Preliminary assessment of Atlantic white marlin (*Tetrapturus albidus*) using a state-space implementation of an age structured production model. Cited as SEDAR 2006 S9RD17 State-Space implementation of ASPM documentation, 23p. March 2014 Gulf of Mexico Greater Amberjack
- Porch, C.E. 1999. A Bayesian VPA with randomly walking parameters. Int. Comm. Conserv. Atl. Tunas. Col. Vol. Sci. Pap. 49(2):314-326.
- Powers, J. E. and Restrepo. 1991. Additional options for age-sequenced analysis. ICCAT Coll. Vol. Sci. Pap. 39:540-553.
- SEDAR. 2006. Southeast Data, Assessment, and Review (SEDAR) 9 Stock Assessment Report 2: Gulf of Mexico Greater Amberjack. SEDAR, North Charleston, SC.
- SEDAR. 2011. Southeast Data, Assessment, and Review (SEDAR) 9 Stock Assessment Update Report: Gulf of Mexico Greater Amberjack. SEDAR, North Charleston, SC.
- SEDAR. 2014. Southeast Data, Assessment, and Review (SEDAR) 33 Stock Assessment Report 2: Gulf of Mexico Greater Amberjack. SEDAR, North Charleston, SC.
- SEDAR. 2014. Addendum Report to SEDAR 33 Gulf of Mexico Greater Amberjack

Stock Assessment Report (SAR): Summary Results for Additional Greater Amberjack Stock Synthesis Analyses Recommended by the SEDAR 33 Review Workshop Panel. SEDAR, North Charleston, SC.

SEDAR. 2016. Southeast Data, Assessment, and Review (SEDAR) 33 Stock Assessment Report Update Report: Gulf of Mexico Greater Amberjack. SEDAR, North Charleston, SC.

Turner, S.C., N.J. Cummings, and C.E. Porch. 2000. Stock assessment of Gulf of Mexico Greater Amberjack using data through 1998. NMFS/SEFSC, Miami Laboratory. Document SFD 99/00-100. 28p.

4 REGIONAL MAPS

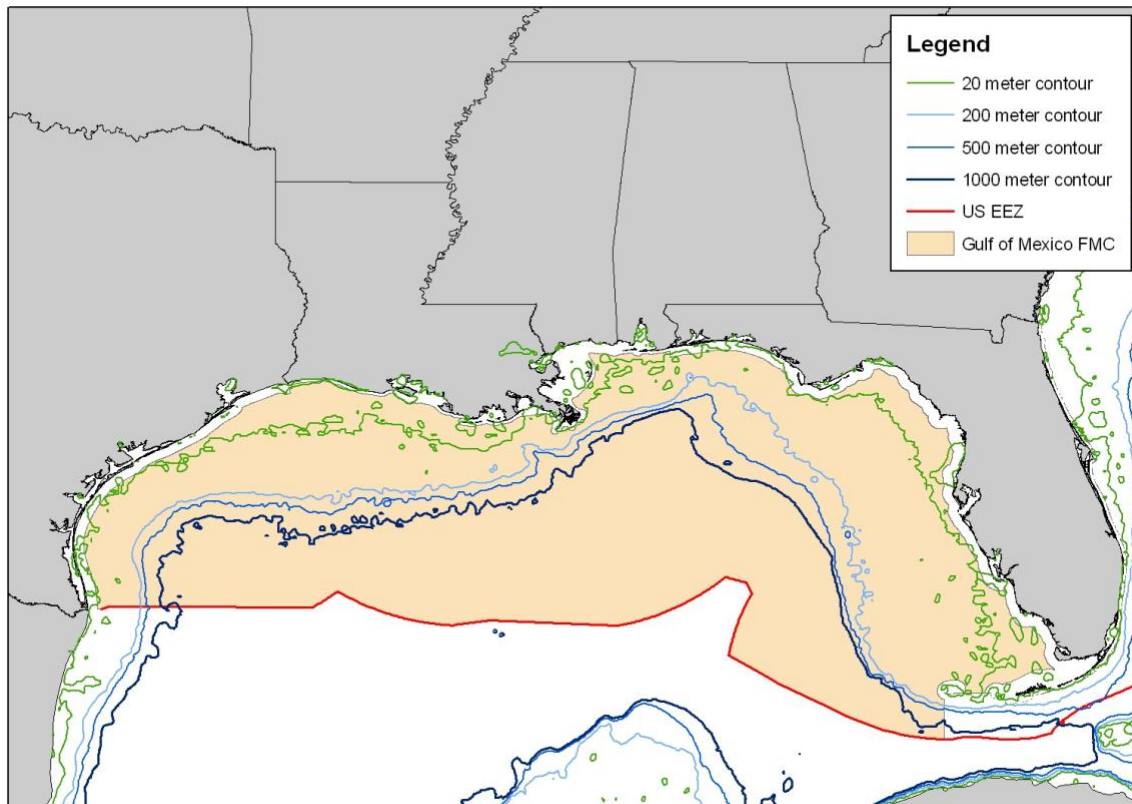

Figure 4.1 Southeast Region including Council and EEZ Boundaries.

5 SEDAR ABBREVIATIONS

ABC	Acceptable Biological Catch
ACCSP	Atlantic Coastal Cooperative Statistics Program
ADMB	AD Model Builder software program
ALS	Accumulated Landings System; SEFSC fisheries data collection program
AMRD	Alabama Marine Resources Division
ASMFC	Atlantic States Marine Fisheries Commission
B	stock biomass level
BAM	Beaufort Assessment Model
BMSY	value of B capable of producing MSY on a continuing basis
CFMC	Caribbean Fishery Management Council

CIE	Center for Independent Experts
CPUE	catch per unit of effort
EEZ	exclusive economic zone
F	fishing mortality (instantaneous)
FMSY	fishing mortality to produce MSY under equilibrium conditions
FOY	fishing mortality rate to produce Optimum Yield under equilibrium
FXX% SPR	fishing mortality rate that will result in retaining XX% of the maximum spawning production under equilibrium conditions
FMAX	fishing mortality that maximizes the average weight yield per fish recruited to the fishery
F0	a fishing mortality close to, but slightly less than, Fmax
FL FWCC	Florida Fish and Wildlife Conservation Commission
FWRI	(State of) Florida Fish and Wildlife Research Institute
GA DNR	Georgia Department of Natural Resources
GLM	general linear model
GMFMC	Gulf of Mexico Fishery Management Council
GSMFC	Gulf States Marine Fisheries Commission
GULF FIN	GSMFC Fisheries Information Network
HMS	Highly Migratory Species
LDWF	Louisiana Department of Wildlife and Fisheries
M	natural mortality (instantaneous)
MARMAP	Marine Resources Monitoring, Assessment, and Prediction
MDMR	Mississippi Department of Marine Resources
MFMT	maximum fishing mortality threshold, a value of F above which overfishing is deemed to be occurring
MRFSS	Marine Recreational Fisheries Statistics Survey
MRIP	Marine Recreational Information Program
MSST	minimum stock size threshold, a value of B below which the stock is deemed to be overfished
MSY	maximum sustainable yield
NC DMF	North Carolina Division of Marine Fisheries
NMFS	National Marine Fisheries Service
NOAA	National Oceanographic and Atmospheric Administration
OY	optimum yield

SAFMC	South Atlantic Fishery Management Council
SAS	Statistical Analysis Software, SAS Corporation
SC DNR	South Carolina Department of Natural Resources
SEAMAP	Southeast Area Monitoring and Assessment Program
SEDAR	Southeast Data, Assessment and Review
SEFIS	Southeast Fishery-Independent Survey
SEFSC	Fisheries Southeast Fisheries Science Center, National Marine Fisheries Service
SERO	Fisheries Southeast Regional Office, National Marine Fisheries Service
SPR	spawning potential ratio, stock biomass relative to an unfished state of the stock
SSB	Spawning Stock Biomass
SS	Stock Synthesis
SSC	Science and Statistics Committee
TIP	Trip Incident Program; biological data collection program of the SEFSC and Southeast States.
TPWD	Texas Parks and Wildlife Department
Z	total mortality, the sum of M and F

SEDAR



Southeast Data, Assessment, and Review

SEDAR 70

Gulf of Mexico Greater Amberjack

SECTION II: Assessment Report

SEDAR
4055 Faber Place Drive, Suite 201
North Charleston, SC 29405

- 1. Workshop Proceedings 3
 - 1.1. Introduction 3
 - 1.2. Workshop time and Place..... 3
 - 1.3. Terms of Reference 3
 - 1.4. List of Participants 4
 - 1.5. List of Working Documents and Reference Papers 5
- 2. Data Review and Update 7
 - 2.1. Stock Structure and Management Unit 8
 - 2.2. Life History Parameters 8
 - 2.2.1. Morphometric and Conversion Factors 9
 - 2.2.2. Natural Mortality Rate 9
 - 2.2.3. Reproduction..... 9
 - 2.2.4. Growth 9
 - 2.2.5. Release Mortality..... 9
 - 2.3. Fishery Dependent Data 9
 - 2.3.1. Landings..... 10
 - 2.3.2. Discards..... 10
 - 2.3.3. Fishery-Dependent Size and Age Composition..... 11
 - 2.3.4. Fishery-Dependent Indices 12
 - 2.4. Fishery-Independent Data 12
 - 2.4.1. Survey Length Composition 12
 - 2.4.2. Combined Video Survey Index..... 13
- 3. Stock Assessment Model and Results 13
 - 3.1. Stock Synthesis Model Configuration..... 13
 - 3.1.1. Initial Conditions 14
 - 3.1.2. Temporal Structure 15
 - 3.1.3. Spatial Structure..... 15
 - 3.1.4. Life History 15
 - 3.1.5. Stock-Recruit 16
 - 3.1.6. Fleet Structure and Surveys 17
 - 3.1.7. Selectivity and Retention 17
 - 3.1.8. Landings and Age Composition..... 18
 - 3.1.9. Discards and Bycatch..... 19
 - 3.1.10. Indices 20
 - 3.1.11. Goodness of Fit and Assumed Error Structure 20
 - 3.1.12. Estimated Parameters..... 20
 - 3.1.13. Model Diagnostics 21
 - 3.1.13.1. Residual Analysis..... 21
 - 3.1.13.2. Correlation Analysis 21
 - 3.1.13.3. Profile Likelihoods..... 21
 - 3.1.13.4. Jitter Analysis..... 22
 - 3.1.13.5. Retrospective Analysis..... 22
 - 3.1.13.6. Sensitivity Runs 22
 - 3.2. Model Results..... 23
 - 3.2.1. Estimated Parameters and Derived Quantities..... 23

- 3.2.1.1. Fishing Mortality 23
- 3.2.1.2. Selectivity 24
- 3.2.1.3. Recruitment..... 25
- 3.2.1.4. Biomass and Abundance Trajectories..... 25
- 3.2.2. Model Fit and Residual Analysis..... 26
 - 3.2.2.1. Landings and Discards..... 26
 - 3.2.2.2. Indices 26
 - 3.2.2.3. Length and Age Compositions..... 26
 - 3.2.2.4. Correlation Analysis 27
 - 3.2.2.5. Profile Likelihoods..... 27
 - 3.2.2.6. Retrospective Analysis..... 27
 - 3.2.2.7. Jitter Analysis..... 28
 - 3.2.2.8. Continuity Model and Model Building Runs 28
 - 3.2.2.9. Sensitivity Model Runs..... 28
- 3.3. Discussion 29
- 4. Projections 31
 - 4.1. Introduction 31
 - 4.2. Projection methods..... 31
 - 4.3. Projection Results..... 32
 - 4.3.1. Biological Reference Points..... 32
 - 4.3.2. Stock Status..... 32
 - 4.3.3. Overfishing Limits 33
 - 4.3.4. FES-only Projections 33
 - 4.4. Discussion 34
- 5. Acknowledgements 34
- 6. Research Recommendations..... 35
- 7. References 36
- 8. Tables..... 37
- 9. Figures 86

1. Workshop Proceedings

1.1. Introduction

SEDAR 70 addressed the stock assessment for Gulf of Mexico Greater Amberjack in the U.S. Gulf of Mexico (GOM) using data inputs through 2018 as implemented in the Stock Synthesis 3 modeling framework (Methot and Wetzel 2013). The assessment process consisted of a series of webinars including one Data webinar and four Assessment webinars held between June and September 2020.

1.2. Workshop time and Place

SEDAR 70 Gulf of Mexico Greater Amberjack assessment process consisted of a series of webinars. Data and Assessment webinars were held between June and September 2020.

1.3. Terms of Reference

The terms of reference approved by the Gulf of Mexico Fishery Management Council (GMFMC) are listed below.

1. Update the approved base model from the 2016 Update of SEDAR 33 Gulf of Mexico greater amberjack with data through 2018.
2. Document any changes or corrections made to model and input datasets and provide updated input data tables. Document changes in MRIP data, both pre- and post-recalibration, in terms of the magnitude of changes to catch and effort.
 - Evaluate spawning condition and abundance data from Gallaway et al. (2018) for greater amberjack on artificial structures in the western Gulf of Mexico.
3. Update model parameter estimates and their variances, model uncertainties, estimates of stock status and management benchmarks, and provide the probability of overfishing occurring at specified future harvest and exploitation levels. Provide commercial and recreational landings and discards in pounds and numbers.
 - Use the following status determination criteria (SDC):
 - $MSY \text{ proxy} = \text{yield at } F_{SPR 30\%} \text{ or } F_{Rebuild} \text{ (if overfished)}$
 - $MSST = 0.5 * B_{SPR 30\%}$
 - $MFMT = F_{SPR 30\%} \text{ and } F_{Rebuild} \text{ (if overfished)}$
 - If different SDC are recommended, provide outputs for both the current and recommended SDC.
 - Unless otherwise recommended, use the geometric mean of the previous three years' fishing mortality to determine $F_{Current}$. If an alternative approach is recommended, provide justification and outputs for the current and alternative approach.
 - Provide yield streams for the overfishing limit and acceptable biological catch in pounds:
 - Annually for five years
 - Under a “constant catch” scenario for both three and five years
 - For the equilibrium yield at F_{MSY} , when estimable

4. Develop a sensitivity run using a secondary model, such as a surplus production model (e.g., Just Another Bayesian Biomass Assessment model (Winker et al. 2018), ASPIC (Prager, 2014) to compare with the proposed base model from Stock Synthesis.
5. Develop a stock assessment report to address these TORS and fully document the input data and results of the stock assessment and the comparison model.

1.4. List of Participants

Panelists

Nancie Cummings (Lead analyst).....	NMFS Miami
Adyan Rios (ASPIC analyst)	NMFS Miami
Robert Allman.....	NMFS Panama City
Matt Campbell	NMFS Pascagoula
Shannon Cass-Calay	NMFS Miami
Kai Lorenzen.....	SSC/UF, Gainesville
Vivian Matter	NMFS Miami
Kevin McCarthy.....	NMFS Miami
Debra Murie	UFL
Carole Neidig.....	Mote Marine Lab
Ashley Pacicco.....	NMFS Panama City
Beverly Sauls	FWC
Jim Tolan	SSC/TXPWD
David Walker	Industry Rep
Beth Wrege	NMFS Miami

Attendees

Sarina Atkinson.....	UM-CIMAS, Miami
Larry Beerkircher.....	NMFS Miami
Tiffanie Cross.....	FWC
LaTreese Denson	NMFS Miami
Michael Drexler	Ocean Conservancy
Eric Fitzpatrick.....	NMFS Beaufort
Kelly Fitzpatrick	NMFS Beaufort
Chris Gardner.....	NMFS Panama City
Jeff Isely.....	NMFA Miami
Michael Larkin.....	NMFS SERO
Dominique Lazarre	FWC, St. Pete
Max Lee	Mote Marine Lab
Rich Malinowski.....	NMFS
Stephanie Martinez	NMFS Miami
Matt Nuttall.....	NMFS Miami
Refik Orhun	NMFS Miami

Kate Overly NMFS Panama City
 Skyler Sagarese NMFS, Miami
 Katie Siegfried NMFS Beaufort
 Alex Smith NMFS Miami
 Steve Smith NMFS Miami
 Molly Stevens NMFS Miami
 Ted Switzer FWC
 Kevin Thompson FWC, St. Petersburg

Council Representation

JD Dugas

Staff

Julie Neer SEDAR
 Chip Collier SAFMC Staff
 Lisa Hollensead GMFMC Staff
 Ryan Rindone GMFMC Staff

1.5. List of Working Documents and Reference Papers

Document #	Title	Authors	Date Submitted
Documents Prepared for the Assessment Process			
SEDAR70-WP-01	SEAMAP Reef Fish Video Survey: Relative Indices of Abundance of Greater Amberjack	Matthew D. Campbell, Kevin R. Rademacher, Paul Felts, Brandi Noble, Joseph Salisbury, and John Moser	5 May 2020
SEDAR70-WP-02	Recreational Survey Data for Greater Amberjack in the Gulf of Mexico	Matter and Nuttall	15 May 2020
SEDAR70-WP-03	Texas Parks and Wildlife Department’s Marine Sport-Harvest Monitoring Program Metadata	Matthew A. Nuttall and Vivian M. Matter	15 May 2020
SEDAR70-WP-04	Commercial Discard Length Composition for Gulf of Mexico Greater Amberjack	Sarina F. Atkinson	29 May 2020

SEDAR70-WP-05	CPUE Expansion Estimation for Total Commercial Discards of Gulf of Mexico Greater Amberjack	Steven G. Smith and Stephanie Martinez	2 June 2020 Updated: 26 June 2020
SEDAR70-WP-06	Something's Fishy with Greater Amberjack Response Summary	GMFMC Staff	2 June 2020
SEDAR70-WP-07	Indices of abundance for Greater Amberjack (<i>Seriola dumerili</i>) using combined data from three independent video surveys	Kevin A. Thompson, Theodore S. Switzer, Mary C. Christman, Sean F. Keenan, Christopher Gardner, Katherine E. Overly, Matt Campbell	8 June 2020 Updated: 4 August 2020
SEDAR70-WP-08	Bottom Longline Discard Summary for Greater Amberjack, <i>Seriola dumerili</i> , with Focus on the West Florida Shelf: Application of Electronic Monitoring	Carole Neidig, Max Lee, Ryan Schloesser, Daniel Roberts	4 June 2020
SEDAR70-WP-09	Discards of greater amberjack (<i>Seriola dumerili</i>) for the headboat fishery in the US Gulf of Mexico	Fisheries Ecosystems Branch, National Marine Fisheries Service, Southeast Fisheries Science Center, Beaufort, NC	26 June 2020
SEDAR70-WP-10	Gulf of Mexico Greater Amberjack (<i>Seriola dumerili</i>) Growth Model for SEDAR 70 Operational Assessment	Debra Murie, Daryl Parkyn, Geoffrey Smith, Robert Allman, Ashley Pacicco, Jessica Carroll, and Nicole Smith	29 June 2020 Updated: 21 September 2020
SEDAR70-WP-11	Standardized Catch Rate Indices for Greater Amberjack (<i>Seriola dumerili</i>) during 1990-2018 by the U.S. Gulf of Mexico Vertical Line and Longline Fisheries	Gulf and Caribbean Branch, Sustainable Fisheries Division	2 July 2020
SEDAR70-WP-12	Greater Amberjack <i>Seriola dumerili</i> Findings from the NMFS Panama City	K.E. Overly, C.L. Gardner and A.G. Pollack	2 July 2020

	Laboratory Camera & Trap Fishery-Independent Survey 2006-2018	
Final Stock Assessment Reports		
SEDAR70-SAR	Gulf of Mexico Greater Amberjack	SEDAR 70 Panel
Reference Documents		
SEDAR70- RD01	Mixing rates in weakly differentiated stocks of greater amberjack (<i>Seriola dumerili</i>) in the Gulf of Mexico	John S. Hargrove, Debra J. Murie, Daryl C. Parkyn, Emily V. Saarinen, James D. Austin
SEDAR70- RD02	Is the BOFFF (Big Old Fat Fecund Females) hypothesis applicable to Gulf of Mexico greater amberjack?	Debra J. Murie, Daryl C. Parkyn, Andrew Fischer
SEDAR70- RD03	Recommended Use of the Current Gulf of Mexico Surveys of Marine Recreational Fishing in Stock Assessments	Office of Science & Technology, Southeast Fisheries Science Center, Southeast Regional Office

2. Data Review and Update

A variety of data sources were used in the SEDAR 70 Operational Assessment. Where practicable, the SEDAR 70 base model used the same data sets as the SEDAR 33 Benchmark and SEDAR 33 Update model with an updated time series. However, there were a few new or revised data sets provided for consideration in the SEDAR 70 stock evaluation. These included the National Marine Fisheries Service's (NMFS) Marine Recreational Information Program (MRIP) Fishing Effort Survey (FES) catch and discard time series, a fishery-independent combined video survey and revised commercial fishery discards. These new data series were considered because they had not previously been available for the SEDAR 33 Benchmark or Update assessments. The data utilized in the SEDAR 70 base model are summarized below and illustrated in Figure 1. Comprehensive descriptions of individual data components are provided within each subsection below:

Biological Data

- Weight- Length Conversions
- Growth
- Reproduction

Natural Mortality
Release Mortality

Fishery-Dependent Data

Commercial Landings: 1963-2018
Recreational Landings: 1950-2018
Commercial Discards: 1993-2018
Recreational Discards: 1981-2018
Commercial Retained Length Compositions: VL 1983-2018; LL 1984-2017
Commercial Age Compositions: VL 2001-2017; LL 2009, 2011, 2013-14
Recreational Retained Length Compositions: Charter+Private 1981-2018; HB 1982-2018
Recreational Age Compositions: Charter+Private 2002-2018; HB 1994-2016
Commercial Discard length compositions: VL 2006-2018; LL 2007-2018
Recreational Discard length compositions: Charter+Private: 2009-2018; HB 2005-2018

Fishery Dependent Indices

Commercial Longline: 1990-2018
Recreational Headboat: 1986-2018
Recreational Charter+Private: 1986-2018

Fishery-Independent Surveys

Combined (SEAMAP MS Labs, PC Lab, FWRI) Video Survey and length composition: 1995-1997, 2002, 2004-2018)

2.1. *Stock Structure and Management Unit*

Two regions (Atlantic and GOM) are currently used by the South Atlantic Fishery Management Council (SAFMC) and GMFMC for Greater Amberjack management. The geographic boundary of these management units occurs from approximately the Dry Tortugas through the Florida Keys and to the mainland of Florida. The SEDAR 33 Benchmark assessment Life History Working Group (LHWG) noted that, “while there was evidence for sub-regional structure in the Gulf, there was not enough compelling evidence to change stock structure” (SEDAR 33 SAR). Therefore, the SEDAR 33 LHWG recommended keeping the two stocks (Atlantic and Gulf) as two separate management units without further subdivision within the Gulf stock. Literature on stock structure reviewed during the SEDAR 70 Data Webinar (SEDAR70-RD-01) supported maintaining the SEDAR 33 stock definition, therefore this stock definition was used to define stock boundaries for SEDAR 70.

2.2. *Life History Parameters*

Life history data used in the assessment included natural mortality, growth, and maturity. Some of the life history data were input to the population model (Stock Synthesis) as fixed values, while other life history parameters were estimated (Figure 2, and see Table 9).

2.2.1. *Morphometric and Conversion Factors*

The relationship between weight and length ($W = aFL^b$) for sexes combined was developed at the SEDAR 33 Benchmark DW, and it was used as a fixed model input (Table 1).

2.2.2. *Natural Mortality*

The Lorenzen age-specific natural mortality vector applied in SEDAR 33 Update was updated using the revised growth inputs and the Hoenig maximum age natural mortality estimator. The cumulative survival of ages 3+ based on a point estimate of natural mortality ($M=0.28$ y⁻¹) was used to scale the age-based estimates of natural mortality (Figure 2 and Table 2). The revised growth parameters were from Murie et al. (SEDAR 70-WP-10) and were based on the size-modified von Bertalanffy growth model as applied in SEDAR 33. The size-based von Bertalanffy model was described by Diaz et al. (2004).

2.2.3. *Reproduction*

The parameters for Greater Amberjack sex ratio and maturity are consistent with those used in the SEDAR 33 Benchmark. For the assessment, reproductive potential (i.e., spawning stock biomass (SSB) was in terms of mature female biomass. The age-specific maturity vector was a fixed input to the model. The SEDAR 70 base model assumed the first fully mature fish, defined as having cortical alveolar (CA) oocytes, was assumed to be age 2 and 50% of fish were assumed to be mature at 82.7 cm. The relationship between female weight and length was updated for this assessment using the information provided in SEDAR70-RD-02.

2.2.4. *Growth*

Additional pairs of length and age were available since the SEDAR 33 Update, and those were used to update the von Bertalanffy growth equation (Figure 2 and Table 3, SEDAR 70-WP-10).

2.2.5. *Release Mortality*

The same discard mortality values recommended by the SEDAR 33 LHWG and used in the SEDAR 33 Benchmark and Update were applied in SEDAR 70. Discard mortality rates of 20% and 10% were used for the commercial and recreational fisheries respectively. These values also reflect that commercial catches are taken in deeper waters on average and commercial discards therefore are likely to suffer greater barotrauma-related mortality.

2.3. *Fishery Dependent Data*

2.3.1. *Landings*

Commercial Landings

Commercial landings data (1963-2018) used in the assessment are presented in Table 4 and Figure 3. The commercial landings are partitioned by fleet (vertical line or handline and longline) and represent the two main commercial harvesting gears capturing Greater Amberjack. Vertical line landings represented approximately 87% of total commercial landings since 1979. Commercial landings were reported in pounds whole weight and converted to metric tons for input to the assessment model.

Recreational Landings

Recreational landings data (1950-2018) used in the assessment are presented in Table 5 and Figure 3. Historical estimates for all recreational modes were estimated using the National Survey of Fishing, Hunting, & Wildlife-Associated Recreation (FHWAR) method following the SEDAR 33 DW recommendations. Fractional effort data were developed from the FHWAR effort estimates for the GOM (excluding shore fishing). It was assumed that the CPUE increased by 2% annually due to improvements in gear and other factors during the historic period. The landings in 1980 were scaled to the mean MRIP landings between 1981 and 1985. Final recreational landings were computed using fully calibrated estimates from the MRIP using FES, the Southeast Region Headboat Survey (SRHS), and the Texas Parks and Wildlife Department (TPWD) data (SEDAR70-WP-02). Recreational landings are reported by mode and include charterboat, headboat, private/rental boat, and shore modes. For the assessment, recreational landings from the private and charter modes were aggregated. As recommended by the SEDAR 33 DW, recreational shore landings were excluded. Private and charter landings represented the dominant mode in the total recreational landings by numbers since 1981. Recreational landings were reported in numbers of fish and input into the assessment model as 1000s of fish.

2.3.2. *Discards*

Commercial Discards

Commercial discards (1993-2018) used in the stock assessment are presented in Table 6 and Figure 4. The commercial discards for Greater Amberjack were estimated using methods revised since the SEDAR 33 Update, and those methods have been recently used for other SEDAR assessments including for GOM red grouper, gray triggerfish, and vermilion snapper (see SEDAR 67 and SEDAR 28 Update). A full description of the commercial Greater Amberjack discards, and estimation procedures is given in SEDAR70-WP-05.

The discard estimates reported in numbers were input into the assessment as 1000s of fish. A discard mortality rate of 20%, as recommended by the SEDAR 33 DW, was applied for the commercial discards.

Recreational Discards

Recreational discards from the Charter+Private and Headboat fleets (1981-2018) used in the assessment are presented in Table 7 and Figure 4. Final recreational discards were computed using fully calibrated estimates from MRIP using FES (SEDAR70-WP-02). Recreational discards were reported as numbers of fish and input into the assessment as 1000s of fish. A discard mortality rate of 10%, as recommended by the SEDAR33 DW, was applied to the recreational discards.

2.3.3. *Fishery-dependent Size and Age Composition*

Commercial Landings Length Composition

Commercial vertical line length compositions of landed (retained) (1983-2018) and discarded fish (2006-2018) are presented in Figures 5 and 6, respectively. Likewise, commercial longline length compositions of landed (retained) fish (1984-2017) and discarded fish (2007-2018) are presented in Figures 7 and 8. The annual length compositions were combined into 5-cm fork length interval bins. These compositions were constructed using the same data sources approved in SEDAR 33 but were processed using revised practices for calculating final compositions. Length samples from the commercial trip intercept program (TIP) were weighted by the commercial landings (Table 4). A description of the revised methods used to develop the length composition data was provided in SEDAR70-WP-13.

Recreational Landings Length Composition

Recreational charter-private length compositions of landed (1981-2018) and discarded fish are presented in Figures 9 and 10, respectively. Recreational headboat length compositions of landed fish (1981-2018) is presented in Figure 11. Length composition samples provided by Florida Fish and Wildlife Commission (FWC) At-Sea Observer Program (2006-2018) were used for characterizing on the recreational headboat discards (Figure 12). The annual length compositions were combined into 5-cm fork length interval bins. These compositions were constructed using the same data sources approved in SEDAR 33 but were processed using revised practices for calculating final compositions. A description of the revised methods used to develop the length composition data was provided in SEDAR70-WP-13.

Commercial Landings Age Composition

Commercial age compositions of landed fish used in the assessment are presented in Figures 13 and 14. The commercial age compositions were weighted using the commercial length compositions of their respective fleet, and a minimum sample size cutoff of 10 fish was used. Weighting the age compositions by the length compositions redistributes the ages to more accurately represent the age composition of the catch taken by the fleet. The methods applied for weighting the age compositions are presented in SEDAR70-WP-13.

Recreational Landings Age Composition

Recreational age compositions of landed fish used in the assessment are presented in Figures 15 and 16. The recreational age compositions were weighted using the recreational length compositions of their respective fleet, and a minimum sample size cutoff of 10 fish was used. Weighting the age compositions by the length compositions redistributes the ages to more accurately represent the age composition of the catch taken by the fleet. The methods applied for weighting the age composition data are presented in SEDAR70-WP-13.

2.3.4. Fishery-Dependent Indices

Commercial Catch per unit of Effort (CPUE)

The standardized CPUE index for the commercial longline fishery used in the assessment is summarized in Table 8 and Figure 17. SEDAR 33 and the SEDAR 33 Update also used a relative index of abundance developed for the commercial vertical line fleet, however the SEDAR 70 Assessment Panel recommended to drop the index. The Panel concluded that the fleet was affected by regulations that substantially changed the fishing behavior (e.g. targeting), and therefore the index did not represent the relative abundance of the stock as it was provided.

Recreational Catch-per-Unit Effort (CPUE)

Two recreational indices were used in the SEDAR 70 assessment: the MRIP Charter+Private index (Figure 18) and the Southeast Region Headboat Survey (SRHS) Headboat Index (Figure 19). The MRIP Charter+Private index tracks total catches of Greater Amberjack (landed plus discards), whereas the Headboat index tracks only landed fish.

The MRIP Charter+Private index used is identical to the SEDAR 33 Update and included the years 1981- 2015 (Table 8, Figure 18). The SEDAR 70 Assessment Panel agreed with recommendations not to extend this index beyond 2015 due to recent regulations in the fishery that changed fishing behavior.

The SRHS headboat index is also identical to the SEDAR 33 Update and included the years 1981- 2015 (Table 8, Figure 19). This index was truncated for the same reasons as those described for the MRIP index.

2.4. Fishery-Independent Data

2.4.1. Survey Length Composition

The length composition data from the combined video sampling for Greater Amberjack from the three separate surveys (SEAMAP, SEFSC Panama City Laboratory, and FWRI) is shown in Figure 20. Previously in SEDAR 33, the survey length composition was input into the assessment as separate time series. For SEDAR 70, the Panel recommended combining the indices across all three surveys, therefore combined length compositions were developed. The length composition data show that the survey reflects abundance of both juvenile and adult Greater Amberjack and are presented in SEDAR 70-WP-07.

2.4.2. *Combined Video Survey Index*

There are three different stationary video surveys for reef fish conducted in the GOM. The NMFS SEAMAP reef fish video survey, carried out by NMFS Mississippi Laboratory (MS Labs; SEDAR70-WP-01), has the longest running time series (1992-1997, 2002, and 2004-2018), followed by the NMFS Panama City lab survey (2005-2018), with the most recent survey being the Florida Fish and Wildlife Research Institute survey (FWRI, 2008-2018). While the surveys use standardized deployment, camera field of view, and fish abundance methods to assess fish abundances on reef or structured habitat, there are variations in survey design and habitat characteristics collected in addition to the time period and area sampled. Updates to the two video survey indices (the MS SEAMAP and the SEFSC PC Lab surveys) considered in SEDAR 33 Update were available. An update of the FWRI index initially presented in SEDAR 33 Benchmark was also presented for use in SEDAR 70. A new index combining the three individual surveys was standardized and presented for review (SEDAR70-WP-07). The SEDAR 70 Assessment Panel recommended the use of the combined video survey in the SEDAR 70 stock assessment (Table 8 and Figure 21). Except in the early years of the index, the combined video index shows moderate annual variability with little to no trend in abundance. However, in the most recent years, a decline in abundance was observed.

The coefficients of variation (CV) associated with each of the standardized indices were converted to log-scale standard errors using:

$$\log(SE) = \sqrt{\log_e(1 + CV^2)}$$

The standard errors as well as all index values by source are presented in Table 8.

3. **Stock Assessment Model and Results**

3.1. *Stock Synthesis Model Configuration*

The primary model used for the GOM Greater Amberjack stock assessment was Stock Synthesis ((SS) (Methot 2010) 3.30.15.09-opt; 2020_07_06). Stock Synthesis has been widely used and tested for assessments, particularly in the US west coast and southeast NMFS centers (Methot 2010). Descriptions of SS algorithms and options are available in the SS user's manual (Methot 2010) and at the NOAA Fisheries Toolbox website (<http://nft.nefsc.noaa.gov/>).

SS is an integrated statistical catch-at-age model (SCAA) that is widely used for stock assessments in the United States and throughout the world. SCAA models consist of three modules: the population dynamics module, an observation module, and a likelihood function. Each of the modules is closely linked. SS uses input biological parameters (e.g., growth, maturity, and natural mortality) to propagate abundance and biomass forward from initial conditions (population dynamics model) and develops predicted data sets based on estimates of fishing mortality, selectivity, and catchability (the observation model). Finally, the observed and predicted data are compared (the likelihood module) to determine best-fit parameter estimates using a statistical maximum likelihood framework (see Methot and Wetzel, 2013 for a

description of equations and complete modeling framework). SS takes relatively unprocessed input data and incorporates many of the important processes (mortality, selectivity, growth, etc.) that operate in conjunction to produce observed catch, size and age composition and CPUE indices. In addition, SS can incorporate time series of environmental data. Because many of these inputs are correlated, the concept behind SS is that these processes should be modeled together, which helps to ensure that uncertainties in the input data are properly accounted for in the assessment. SS has the ability to incorporate an early, data-poor time period for which only catch data are available and a more recent, data-rich time period for which indices of abundance and length and age-length or age compositions are available.

Uncertainty in parameter estimates was quantified by computing asymptotic standard errors for each parameter. Asymptotic standard errors are calculated by inverting the Hessian matrix (i.e., the matrix of second derivatives) after the model fitting process. Asymptotic standard errors provide a minimum estimate of uncertainty in parameter values.

The r4ss software (www.cran.r-project.org/web/packages/r4ss/index.html) was utilized extensively to develop various graphics for the SS outputs and was used to summarize various SS output files and to initially conduct the parametric bootstrap.

The Greater Amberjack (GAJ) SS model assumed a similar configuration structure as developed for the previous SEDAR 33 GAJ Benchmark. The fully configured GAJ SS model included observations of catch and discards for four fishery fleets (commercial vertical line, commercial longline, an aggregated recreational private and charter boat fleet, and headboat). The model included three fishery dependent CPUE indices of abundance (commercial longline, MRIP Charter+Private, and headboat), and a single fishery independent time series (Combined Video Survey). Model estimated parameters include fishing mortality by fleet for each year, selectivity and retention parameters for each directed fleet, parameters describing the stock-recruit function, and stock-recruit deviation parameters. The SS modeling framework provides estimates for key derived quantities including: time series of recruitment, abundance, biomass, spawning stock biomass, and harvest rate. Projections are implemented within SS starting from the year succeeding the terminal year of the assessment model utilizing the same population dynamics equations and modeling assumptions (with some minor alterations in assumptions to account for forecasting recruitment).

3.1.1. Initial Conditions

The SEDAR 70 assessment began in 1950 and the terminal year was 2018. Some landings are believed to have occurred prior to 1950, mainly for the recreational Charter+Private and headboat fleets, thus the population was not assumed to be in equilibrium.

Recreational fishery removals were available since 1981 and were hindcast from 1950 to 1980 as recommended by the SEDAR 33 DW (see Table 14). As noted in the data section, the history of reported commercial landings exists since 1963; although the general belief is that some small amount of commercial removals occurred prior to 1963.

3.1.2. *Temporal Structure*

In the SS GAJ model, the population was modeled from age 0 through age 10+, with the last age representing a plus group. Data collection and fishing activities were assumed relatively continuous throughout the year; therefore, inclusion of a seasonal component to the removals was not deemed necessary. Fishing and spawning seasons were assumed to be continuous and homogeneously distributed throughout the year.

3.1.3. *Spatial Structure*

Two management groups (Atlantic and GOM) are currently used by the SAFMC and GMFMC for Greater Amberjack management. The geographic boundary of these management units occurs from approximately the Dry Tortugas through the Florida Keys and to the mainland of Florida. Literature on stock structure reviewed during the SEDAR 70 Data Webinar (SEDAR70-RD01) supported maintaining the SEDAR 33 stock definition, therefore this stock definition was maintained for the SEDAR 70 Operational assessment.

3.1.4. *Life History*

Growth was modeled internally in SS as both sexes combined with a three parameter von Bertalanffy equation (L_{\min} , L_{\max} , and K). As in the previous SEDAR 33 Benchmark and SEDAR 33 Update, the L_{∞} parameter was fixed in the final base model. Early SS model runs indicated that estimation of the L_{∞} parameter was not stable as in SEDAR 33. For SEDAR 70, the von Bertalanffy growth model parameters were re-estimated using updated observations of length and age pairs obtained since SEDAR 33 update. The updated parameters are provided in Table 3 as taken from SEDAR70-WP-10, and the L_{∞} parameter is used as an input in the SS model. Murie et al. (2020) applied a size-modified von Bertalanffy model to estimate growth parameters for SEDAR 70.

In addition, the length-weight relationship was used to convert from size to biomass, and the maturity parameters are used to assign a spawning output to each modeled fish. A fixed power function weight-length relationship was used to convert body length (cm) to body weight (kg; Table 1). Maturity was modeled as a logistic function where length at 50% maturity was estimated to be 82.7 cm (SEDAR70-RD-02). However, the assessment model is parameterized so that all age-0 fish, regardless of size, are not mature (i.e., do not add to the spawning stock biomass). Table 2 provides the age-specific Lorenzen natural mortality inputs used for Greater Amberjack in the SEDAR 70 assessment.

3.1.5. *Stock-Recruit*

A Beverton-Holt stock-recruit function was used to parametrize the relationship between spawning output and resulting recruitment of age-0 fish. The stock-recruit function (representing the arithmetic mean spawner-recruit levels) requires three parameters: steepness (h) characterizes the initial slope of the ascending limb (i.e., the fraction of virgin recruits produced at 20% of the equilibrium spawning biomass); the virgin recruitment ($R0$; estimated in log space) represents the asymptote or unfished recruitment levels; and the variance term ('sigma_R', σR) is the standard deviation of the log of recruitment (it both penalizes deviations from the spawner-

recruit curve and defines the offset between the arithmetic mean spawner-recruit curve and the expected geometric mean from which the deviations are calculated).

Although the S/R parameters are often highly correlated, they can be simultaneously estimated in SS. During SEDAR 33 and in initial model runs SEDAR 70, the three stock-recruit parameters were directly estimated. This resulted in estimates of the recruitment variance term (σR) of 0.52 and steepness (h) of 0.78. These values were also the minima of the likelihood profiles, though the likelihood profiles were somewhat flat in the regions where the minima occurred. However, further exploratory runs with the updated data in SEDAR 70 indicated that freely estimating these two S/R parameters sometimes led to model instability. Therefore, the SEDAR 70 Panel recommended fixing the recruitment variance term and steepness at the estimated values, i.e., (σR) at 0.52 and steepness (h) at 0.78. Fixing these parameters resulted in increased model stability for sensitivities and improved retrospectives (see Section 4.3.4). For forecasts, it was assumed that average recent recruitment would derive from the stock-recruit relationship directly.

Annual deviations from the stock-recruit function were estimated in SS as a vector of deviations forced to sum to zero and assuming a lognormal error structure. A lognormal bias adjustment factor was applied to recruitment estimates as recommended by Methot et al. (2019), but only to the data-rich years in the assessment. This was done so that SS will apply the full bias-correction only to those recruitment deviations that have enough data to inform the model about the full range of recruitment variability (Methot et al., 2019). For the SEDAR 70 model, prior to 1984, no length or age composition data were available, therefore no recruitment deviations were estimated. Instead the recruitment was fixed at the expected value obtained from the spawner-recruit relationship. Full bias adjustment was used from 1985 to 2018 when length and age composition data are available. Bias adjustment was phased in linearly, from no bias adjustment prior to 1979 to full bias adjustment in 1984. Bias adjustment was phased out over the last four years (2015-2018), decreasing from full bias adjustment to no bias adjustment, because the age composition data contains little information on recruitments for those years. Prior to 1985, recruitment is estimated as a function of spawning stock biomass based on the stock-recruit parameters (i.e., there is no deviation in recruitment estimates from the stock-recruit curve). The years selected for full bias adjustment were estimated following the methods of Methot and Taylor (2011).

It is also important to note that as in SEDAR 33, the stock was not thought to be at the unexploited equilibrium level in the beginning year of the assessment (i.e., start year = 1950). In the SEDAR 33 Benchmark and update (which used SS3.24_S) this was handled through implementing an offset parameter (R1). In SS 3.30 (used in the SEDAR 70 Operational assessment) this was handled through the implementation of an SR regime parameter (SR_regime). In SEDAR 70 (using version SS3.30_15) the R1 approach was implemented by replacing R0 by

$$R0 * \exp(SR_regime[y]).$$

And adding a block on SR_regime for $y = \text{startyr} - 1$.

A penalty on deviations from the stock-recruit curve was also included (essentially a Bayesian prior) in order to limit recruitment deviations from differing too greatly from the assumed relationship. The variance term was controlled by the fixed σR parameter.

3.1.6. *Fleet Structure and Surveys*

For SEDAR 70, four fishing fleets were modeled and each had associated length and age compositions. The fleets were: commercial vertical line (Com_VL), commercial longline (Com_LL), an aggregated recreational charter and private mode fleet (Charter+Private), and the headboat fleet (HB). Fleet structure was characterized by the availability of length and age composition data and resulting sample sizes. Recreational Charter+Private mode landings and age compositions were summed across modes and regions and a single selectivity curve and time series of fishing mortality were estimated. Fishing was assumed to be continuous and homogenous across the entire year. Four fishery-dependent CPUE indices were modeled and considered in the initial model runs. Com_VL, Com_LL, Charter+Private, and HB. Subsequently the Panel recommended to exclude the Com_VL index from the base model configuration as this index was not considered to reflect abundance due to the regulatory effects on fishing behavior.

A single fishery-independent survey from the reef fish combined video survey was also fit by the SS model. The video survey also included length composition information, which was fit directly in the model and was believed to reflect abundance of juveniles and adults.

Because SS includes the growth equations directly and models individual fish from birth, it actually grows fish by length bins before eventually converting to age (based on the growth curve). As such, it is possible to fit both age and length composition. In SS fish recruit at age-0, grow linearly from the size of the lower edge of the first population size bin (5cm fork length for GAJ) until the value for SS parameter L_{min} and then grow according to the von Bertalanffy growth curve. Because no age information was available for the surveys, the length composition was fit directly based on estimated length-based selectivity functions.

3.1.7. *Selectivity and Retention*

Selectivity represents the probability of capture by age or length for a given fishery and represents the net result of multiple interrelated factors (e.g., gear type, targeting, and availability of fish due to spatial and temporal structure). Size-based selectivity patterns were specified for each fishery and survey in the SS model and were characterized as one of three functional forms: a two-parameter logistic function, the 6-parameter double normal, or a spline function (see Methot et al., 2019). The double normal has the feature that it allows for domed or logistic selectivity and is a combination of two normal distributions; the first describes the ascending limb, while the second describes the descending limb. A line segment joins the maximum selectivity of the two functions. The logistic function fits an asymptotic selectivity function, which is frequently used to model longline length compositions. The spline function also allows domed selectivity and was selected for modeling the selectivity of the Com_VL fleet as it performed better than the double normal in fitting the length compositions. The Com_VL length compositions exhibited several peaks (in the small and some large size intervals) particularly in

the early years and the spline function was able to better fit these years than the double normal. The number of knots and initial locations were specified on initial exploration runs to allow a smooth curve in the final fit.

In the base model, separate selectivity patterns were defined in SS for each fleet/survey as: 1) COM_VL (spline function with 5 nodes), 2) Com_LL (two parameter logistic), 3) Charter+Private (six parameter double normal, 4) HB (six parameter double normal), and 5) combined video index (logistic). The length-based selectivity patterns of the Com_LL, Charter+Private and HB index were assumed to mirror the selectivity pattern of their respective fleets. Selectivity patterns were assumed to be constant over time for each fishery and survey as assumed in the previous SEDAR 33 Benchmark and SEDAR 33 update evaluations.

Both the Com_LL and the combined video survey assumed logistic selectivity. The length compositions provided reasonable support that both younger and older fish were available to the longline fishery and the video survey camera gear. Additionally, the use of the double normal to allow dome-shaped selectivity for the Charter+Private and HB fisheries was considered appropriate. In particular, dome-shaped selectivity was considered highly likely due to the targeting behavior and areas fished by the Charter+Private and HB fleets.

Each of the directed fisheries was also assumed to have regulatory discards based on selection (catch) of fish below the minimum size limit. As was used for the SEDAR 33 assessments, time-varying retention functions were used to allow for varying discards at size due to the impacts of fishery minimum size limits and bag limits. These regulations were first implemented in 1990 (36 inch fork length- COM_VL, COM_LL and 28 inch fork length- Charter+Private, HB). Adjustments to the recreational fleets minimum sizes were enacted for in 2008 (30 inches fork length- Charter+Private, HB) and revised in 2016 (34 inches fork length). Additional retention time blocks were defined for both the recreational and commercial fisheries relating to fishery closures and management quotas (2008- COM_VL, and 2009- Charter+Private, Headboat).

To summarize, the time varying retention blocks were defined as:

- 1) COM_VL: 1950-1989, 1990-2007, 2008-2010 and 2011-2018
- 2) COM_LL: 1950-1989 and 1990-2018.
- 3) Charter+Private and HB: 1950-1989, 1990- 1997, 1998-2007, 2008-2015 and 2016-2018.

3.1.8. *Landings and Compositions*

Landings by fleet and associated length and age compositions were estimated using fleet-specific continuous fishing mortality rates and age-specific selectivity curves following Baranov's catch equation. The commercial landings were assumed the most representative and reliable data source in the model, especially over the most recent time period, because this information was collected in the form of a census as opposed to being collected as part of a survey. The recreational landings were assumed to be less precise than the commercial fisheries, because the Charter+Private component was collected using the MRIP-FES, albeit with a relatively large sample size. Similarly, the headboat fishery was considered less reliable than the commercial but generally is thought to be more precise than the MRIP charter and private fleets. The landings data were assumed to have a lognormal error structure with a constant variance. The input

standard error for the landings was set to 0.05 for both the commercial vertical line and longline fleets. The input standard error for the MRIP Charter+Private landings was set to 0.25, and it was set to 0.21 for the HB fishery.

The age and length composition data for each fleet/survey was assumed to follow a Dirichlet multinomial error structure where sample size represented the number of fish, adjusted by an estimated variance inflation factor. The multinomial was used for previous GAJ stock assessments. Using the multinomial, a smaller sample size represents higher variance and vice versa, because the number is meant to represent the number of fish sampled each year to determine the composition. Observed sample sizes are often overestimated for fisheries data, because samples are rarely truly random or independent (Hulson *et al.*, 2012). In addition, using higher effective sample sizes can lead to the composition data dominating the likelihood and reduce fit to other data sources. Iterative reweighting is often undertaken in order to adjust the effective sample size to better represent the residual variance between observed and predicted values (Methot and Wetzel, 2013).

A new feature available for fitting composition data in SS is the Dirichlet multinomial which differs from the standard multinomial in that it included an estimable parameter (θ) which scales the input sample size (DM, Methot and Wetzel, 2013). The DM is self-weighting, which avoids the potential for subjectivity as when the Francis re-weighting procedure is applied. The DM approach also allows for observed zeros in the data, and the effective sample sizes calculated are directly interpretable. The DM uses the input sample sizes directly, adjusted by an estimated variance inflation factor. The more positive the inflation factor, the more weight the data carry in the likelihood. For SEDAR 70, the DM was used, and the final effective sample sizes for each year are provided on the figures illustrating the age composition and length composition (given by N in each panel). In the previous SEDAR 33 Benchmark and Update assessments, the Francis approach was used for final composition weightings. The DM is considered an improved practice and recommended for use by the SS model developers and the SEDAR 70 application is the first SEFSC SS assessment to apply the DM weightings.

3.1.9. *Discards and Bycatch*

Directed fleets discard data were directly fit in the SS model using size-based retention functions, and a normal error structure was assumed. The discard mortality rates (0.2 commercial, 0.10 recreational) were then applied to the discarded fish to determine the level of dead discards from each fleet.

3.1.10. *Indices*

The indices are assumed to have a lognormal error structure.

The interannual variation in the CPUE and survey indices was estimated through the index standardization techniques and was used to inform the error around the final observed index values. For the indices, the coefficient of variation (CV ; standard error divided by mean) was converted to a standard error (SE) in log space (required for input to SS3 for lognormal error structures) as:

$$\log(SE) = \sqrt{\log_e(1 + CV^2)}$$

3.1.11. *Goodness of Fit and Assumed Error Structure*

A maximum likelihood approach was used to assess goodness of model fit to each of the data sources (e.g., catch, indices, compositions, etc.). For each separate data set, an assumed error distribution and an associated likelihood component was specified, the value of which was determined by the difference in observed and predicted values along with the assumed variance of the error distribution. The total likelihood was the sum of each individual component. A nonlinear iterative search algorithm was used to minimize the total negative log-likelihood across the multidimensional parameter space to determine the parameter values that provide the best fit to the data. With this type of integrated modeling approach, data weighting (i.e., the variance associated with each data set) can impact model results, particularly if the various data sets indicate differing population trends.

In the SS model fitting, iterative reweighting of index variances was applied by adding the SS estimated variance adjustment to the survey input error (i.e., the standard deviation) for each index and then re-running the model and repeated until the estimated new variance adjustment did not change. This commonly requires from one to two iterations.

Weak penalty functions were implemented to keep parameter estimates from hitting their bounds, which includes a symmetric-beta penalty on selectivity parameters (Methot et al., 2019). Parameter bounds were set to be relatively wide and were unlikely to truncate the search algorithm.

Uncertainty estimates for estimated and derived quantities were calculated based on the asymptotic standard error determined from the inversion of the Hessian matrix (i.e., the matrix of second derivatives) is used to determine the level of curvature in the parameter phase space and calculate parameter correlation; (Methot and Wetzel, 2013)).

3.1.12. *Estimated Parameters*

In all, 426 parameters were estimated for the SEDAR 70 GAJ base model, of which 349 were active parameters (Table 9). These parameters include: year specific fishing mortality for the four directed fleets 1950-2018, six parameters informing the commercial vertical line selectivity, logistic selectivity parameters for the commercial longline fleet and video survey, six dome-shaped selectivity parameters for the recreational fleets and the survey, logistic retention parameters for each directed fleet, 4 fleet-specific coefficients; one stock-recruit relationship parameter (R0), the stock-recruit deviations for the data-rich time period, the growth rate parameter (k), two initial fishing mortality rates for the Charter+Private and HB fleets in 1950 corresponding to the year when the stock was not in equilibrium, and 9 parameters informing the Dirichlet multinomial length and age composition weightings.

3.1.13. *Model Diagnostics*

3.1.13.1. Residual Analysis

The main approach used to address model fit and performance was residual analysis of model fit to each of the data sets (e.g., catch, indices, length/age compositions, discards). Any temporal trends in model residuals (or trends with age or length for compositional data) can be indicative of model misspecification and poor performance. It is not expected that any model will perfectly fit any of the observed data sets, but ideally, residuals will be randomly distributed and conform to the assumed error structure for that data source. Any extreme patterns of positive or negative residuals are indicative of poor model performance and potential unaccounted for process or observation error.

3.1.13.2. Correlation Analysis

High correlation among parameters can lead to flat likelihood response surfaces and poor model stability. By performing a correlation analysis, modeling assumptions that lead to inadequate model parameterizations can be highlighted. Because of the highly parameterized nature of stock assessment models, it is expected that some parameters will always be correlated (e.g., stock recruit parameters). However, a large number of extremely correlated parameters warrant reconsideration of modeling assumptions and parametrization. A correlation analysis was carried out for the SEDAR 70 GAJ assessment and no correlations with an absolute value greater than 0.7 were reported.

3.1.13.3. Profile Likelihood

Profile likelihoods are used to examine the change in log-likelihood for each data source in order to address the stability of a given parameter estimate, and to see how each individual data source influences the estimate. The analysis is performed by holding the given parameter at a constant value and rerunning the model. This is repeated for a range of reasonable parameter values. Ideally, the graph of likelihood values against parameter values will give a well-defined minimum, indicating that data sources are in agreement. When a given parameter is not well estimated, the profile plot may show conflicting signals across the data sources. The resulting total likelihood surface will often be flat, indicating that multiple parameter values are equally likely given the data. In such instances, the model assumptions need to be reconsidered.

Typically, profiling is carried out for a few key parameters, particularly those defining the stock-recruit relationship. For the SEDAR 70 base model, profiles were carried out for steepness, virgin recruitment, stock-recruit variance, and a combination of steepness and stock-recruit variance. These runs were utilized to aid in determining the appropriateness of the fixed value for the recruit variance term in the final base model.

3.1.13.4. Jitter Analysis

Jitter analysis is a relatively simple method that can be used to assess model stability and to determine whether a global as opposed to local minima has been found by the search algorithm. The premise is that all of the starting values are randomly altered (or ‘jittered’) by an input

constant value and the model is rerun from the new starting values. If the resulting population trajectories across a number of runs converge to the same final solution, it can be reasonably assumed that a global minimum has been obtained. This process is not fault-proof and no guarantee can ever be made that the ‘true’ solution has been found or that the model does not contain misspecification. However, if the jitter analysis results are consistent, it provides additional support that the model is performing well and has come to a stable solution. For this assessment, a jitter value of 0.1 was applied to the starting values and 100 runs were completed.

3.1.13.5. Retrospective Analysis

A retrospective analysis is a useful approach for addressing the consistency of terminal year model estimates. The analysis sequentially removes a year of data at a time and reruns the model. If the resulting estimates of derived quantities such as SSB or recruitment differ significantly, particularly if there is serial over- or underestimation of any important quantities, it can indicate that the model has some unidentified process error, and requires reassessing model assumptions. It is expected that removing data will lead to slight differences between the new terminal year estimates and the updated estimates for that year in the model with the full data. Oftentimes additional data, especially compositional data, will improve estimates in years prior to the new terminal year, because the information on cohort strength becomes more reliable. Therefore, slight differences are expected between model runs as more years of data are peeled away. Ideally, the difference in estimates will be slight and more or less randomly distributed above and below the estimates from the model with the complete data sets. A four-year retrospective analysis was carried out for SEDAR 70 base model.

3.1.13.6. Sensitivity Runs

Sensitivity runs were conducted in order to investigate critical uncertainty in data and reactivity to modeling assumptions. The sensitivity analyses focused on impact of removal of CPUE indices and a sensitivity using the ASPIC model (Prager 2014, 2016) requested in the SEDAR 70 TORs.

The ASPIC sensitivity model was a near continuity run of the ASPIC model from the SEDAR 33 Benchmark stock assessment. The departure from the SEDAR 33 continuity method was related to two changes that reflect SEDAR 70 data decisions: using the MRIP-FES recreational data and removing of the commercial vertical line index of abundance. The data inputs for the ASPIC sensitivity run are annual removals in pounds and an index of abundance for each fleet. The model had two recreational fleets (headboat, and combined Charter+Private) and one combined commercial fleet (combined longline and vertical line; using longline index). SEDAR 70 recreational removals in numbers were converted to pounds using the methods described in SEDAR 33 SAR and using the same 3-year running averages by mode that were reported in the SEDAR 33 SAR. The average weights for the conversion for 2012-2018 were set as the average of the last three years (2009-2011) of the SEDAR 33 values. The B1/K parameter represented the stock beginning in year 1986.

3.2. Model Results

3.2.1. *Estimated Parameters and Derived Quantities*

Table 9 contains a summary of model results for the SEDAR 70 base model. Results included are predicted parameter values and their associated standard errors from SS, initial parameter values, minimum and maximum bounds on parameters, and the prior densities assigned to each parameter (if a prior was used). Most parameter estimates and variances were reasonably well-estimated as indicated by acceptable standard errors. The estimation of several of the parameters, in particular the selectivity and retention parameters, were improved from the SEDAR 33 Update as evidenced by lower asymptotic standard errors. There were no bounded parameters in the SS base run. This was an improvement since the SEDAR 33 update assessment model contained several bounded parameters.

3.2.1.1. *Fishing Mortality*

Total harvest rate (total biomass killed divided by total exploitable biomass, age-1+) for the entire stock and fishing mortality by fleet (continuous rates) are provided in Tables 10 and 11 and Figure 22. As the stock became exploited in the early 1950s and moved away from near virgin conditions, the harvest rate remained at relatively low levels (less than ~ 0.1) through the early 1970s. Exploitation then climbed at a moderate rate through the mid-1970s (around ~ 0.15) when the commercial vertical line and recreational Charter+Private directed fisheries became very active. After the late 1970s exploitation rates continued to increase until the mid-1990s when harvest rate peaked around 64% (1987). Since that time, across all fleets together, exploitation rate has fluctuated with several periods of declining (1990-2000) and then increasing exploitation (2001-2005). Since about 2009 exploitation rates have generally shown a declining trend except from 2010-2013 when increasing harvest rates were estimated.

Table 11 and Figure 23 provide estimates of apical fishing mortality by fleet and year. The results show that over the time series, 1950-2018, that the commercial vertical line and recreational Charter+Private fleets dominated the removals of Greater Amberjack. Both of these fleets showed increasing and intense exploitation trends during the late 1970's through the mid-1990s, with the commercial vertical line indicating a general declining trend in exploitation since then. In contrast, the Charter+Private fleet, while showing some decline in exploitation from the mid- to the late 1990's, has shown a general increasing pattern of fishing mortality through time.

Generally, both the commercial longline and the headboat fleets indicated very low exploitation levels in all years, generally less than 0.03 and 0.02 for commercial longline and headboat respectively (Figure 23).

The terminal year (2018) fishing mortality rates for the commercial vertical line, commercial longline, Charter+Private fleet, and headboat fleets were 0.1, 0.01, 0.67, and 0.02 respectively (Table 11). The terminal year (2018) fishing mortality rate across all fleets was 0.28.

3.2.1.2. *Selectivity*

A comparison of the SS estimated length-based selectivity functions for each directed fleet for GOM GAJ from the SEDAR 70 and SEDAR 33 Update models is shown in Figure 24. The top panel shows the results from using the spline function to model selectivity of the commercial vertical line length compositions in the SEDAR70 assessment instead of the double normal function applied in SEDAR 33. The spline function allowed the length composition observation data to be fit better than the double normal. Figures 25-28 provide fleet specific terminal year (2018) selectivity, retention, discard mortality and fraction of fish kept, dead and discarded for the four directed fisheries for both the SEDAR 70 and SEDAR 33 assessments. Figure 29 presents SS derived age-based selectivity for each fleet in 2018. Generally, the commercial vertical line fleet reached maximum selectivity around age 6 and 50% selectivity at age 4. The commercial longline age of 50% selection occurred at age 6.5. The Charter+Private and headboat fleets both attain maximum selection at age 4. Both recreational fleets indicate higher selection for younger fish with both fleets showing 50% selectivity around age 2.5. In addition, selectivity falls substantially for ages >7 for both the Charter+Private and headboat fleets. These results are in agreement with the observed age compositions from the four directed fisheries given the increased proportion of younger fish in the recreational fishery. Time-varying retention functions, by time block, are provided for each directed fleet and are shown in Figures 30-33. As expected, retention shifted to larger fish as the minimum size limit increased.

The estimated length-based selectivity functions for the recreational Charter+Private survey, the combined video survey for the SEDAR 70 assessment and also the two fishery independent surveys from SEDAR 33 are shown in Figure 34a. The derived age-based selectivity functions for the fleets and surveys are shown in Figure 34b. As noted earlier the Assessment Panel recommended to only use the combined video survey and to drop the SEAMAP and PC Lab fishery independent surveys. The SEDAR 70 base model assumed a dome-shaped selectivity function and the combined video survey represented indices and length compositions developed from three independent surveys (SEAMAP, NMFS/SEFSC Panama City Laboratory, and FWRI time series). In combination, the three surveys reflect fish of a broad size range covering juveniles and adults. Maximum (full) selectivity occurred at around 50cm for the combined video survey, which is close to what was estimated for the SEAMAP survey in SEDAR 33.

3.2.1.3. *Recruitment*

Estimated annual recruitment of age-0 fish (1000s) from 1950-2018 including recruitment deviations and variance are shown in Table 12 and Figures 35-38. As noted in the description of the SS model configuration, two of three of the S/R parameters were fixed at values resulting from the best model configuration, as determined by the Panel, steepness (0.78) and sigmaR the recruit variance parameter (0.52) to improve model stability. The SEDAR 70 base model estimated value for R0 was 8.215 in log space, estimating a virgin recruitment of 3.7 million fish.

There were no indications of strong autocorrelation patterns in recruitment deviations (Figures 36-37). In the base model, recruitment was forced to follow the stock-recruit curve for the historical time period (prior to 1984) and slowly decreased from near-virgin conditions as the stock became more intensively exploited (Figure 36, Table 12). Since the mid-1980s (when recruitment deviations were estimated), recruitment has fluctuated between 0.87 (1995) and 6.11 million fish (1985) and averaged 2.16 million fish across the time period.

The time series indicates three years (1983, 1985, 1988) with recruitment higher than 5 million fish, followed by declining recruitment through 1998, and then indicates two years with recruitment at 3.67 (1999) and 4.27 million fish (2000), these years (1999 and 2000) representing the second highest recruitment for GOM Greater Amberjack since the mid 1980's (Table 12). The terminal year recruitment (2018) was estimated to be slightly below the average (at approximately 1.81 million fish).

3.2.1.4. *Biomass and Abundance Trajectories*

The estimated annual total biomass (metric tons), spawning stock biomass, and abundance (numbers of fish) from 1950-2018 including 95% confidence intervals are contained in Table 12 and Figures 39-41.

Steady declines in Greater Amberjack biomass (spawning and total) occurred as the stock moved away from near virgin conditions in 1950 and was increasingly exploited by the commercial vertical line fleet (until the early 1990s) and by the recreational Charter+Private fleet until 2012 except for a very brief decline in exploitation between 1995 and 2000 (Table 12, Figures 39-40). The trend in stock biomass reached the lowest levels in 1997 only showing modest increases in total biomass since then between 2000 and 2010, which was followed by further declines. Estimated spawning stock biomass in the most recent year (2018) is predicted to be 10% of the corresponding unfished spawning stock biomass (Table 12).

Total abundance shows similar trends as biomass and SSB (Table 12, Figures 39-40). Estimated spawning biomass ratios (SSB/SSB_0) reached very low levels, below 10%, between 1989 and 2001. After 2001 estimated SSB increased above 10% in some years. However, estimates still indicated several years of very low abundance, particularly from 2006-2009. Average age in the stock at virgin conditions was age 2, and the average age in 2019 was age 1.1 (Figure 41).

3.2.2. *Model Fit and Residual Analysis*

3.2.2.1. *Landings and Discards*

Due to the comparatively small standard error assumed for the landings data (0.05 for commercial, 0.21 for headboat, and 0.25 for recreational Charter+Private), the landings were fit quite well in the SS base model (Tables 13-14, Figure 42). The commercial landings were fit almost exactly. However, according to the model, the recreational Charter+Private fleet landings were slightly overestimated for a few years in late 1980s and early 1990s, and again for a few years in the mid-2000s. Overall, no strong residual patterns were noticeable and fits to the landings data were very good.

The time series of commercial discards begins in 1992, two years after the implementation of the 36 inch (fork length) minimum size limit. Observed and expected values are summarized in Table 15. Generally, the discards were relatively low for both the commercial vertical line

and commercial longline fleets, though the commercial longline fleet had fewer discards than the commercial vertical line. Discards were estimated with a large assumed uncertainty, and therefore were characterized by large confidence intervals for both commercial vertical line and commercial longline fleets (Figure 43).

The time series of discards for the recreational Charter+Private and headboat fleets begins in 1981 (Table 16, Figure 43). The Charter+Private fleet discards showed a steady increase through the early 1990s, including a peak following the 28-inch minimum size limit implementation in 1990 and reached a time series high in 2001. Since 2001, Charter+Private discards mostly fluctuated without any strong trend. Discards from the headboat fleet were generally low in all years (<10,000 fish) except in 1990, the year of the 28-inch minimum size limit. Since about 2010, headboat discards have averaged less than 5,000 fish annually.

3.2.2.2. *Indices*

Observed and predicted CPUE are provided in Tables 17-18 and Figure 44. The model fits both the combined video survey and the headboat indices well. The model fits the MRIP index, though not as well as the other indices. The fit to the commercial longline index predicted a slight increase in CPUE in recent years while the MRIP, headboat and combined video survey predicted either slight declining or flat CPUE for recent years.

3.2.2.3. *Length and Age Compositions*

Model fits to the retained and discarded length composition data are provided in Figures 45-52. The aggregate fit to the length composition data were improved over the SEDAR 33 Update assessment (Figure 53), and unlike the SEDAR 33 Update, no strong residual patterning was evident (Figure 54). Generally, the SEDAR 70 length composition fits are much improved from the SEDAR 33 model fits.

The age compositions were reasonably fit by the model given the small sample sizes and the two fixed growth parameter estimates (Figures 55-59). There were no strong indications of patterns in residual distributions. Generally, the fits were similar to the age composition fits of the SEDAR33 Update except for the commercial vertical line and commercial longline which were both fit better in the SEDAR 70 assessment. (Figure 60).

3.2.2.4. *Correlation Analysis*

A summary of correlations for the base model parameters considered as outliers is contained in Table 19. There were no parameters in the SEDAR 70 base model that indicated correlation coefficients of +/- 0.9. The results did indicate several of the retention and selectivity parameters were correlated at levels of +/- 0.7 to +/- 0.85. For example, Table 19 shows that the inflection parameter for the retention function for the recreational Charter+Private fleet was correlated with the ascending parameter of the double normal selectivity function. Correlation among these

parameters is also not unusual, especially for the selectivity parameters, because the parameters of selectivity functions are inherently correlated.

3.2.2.5 *Profile Likelihoods*

Profile likelihoods were calculated for each of the stock-recruit parameters: steepness, σ_R , and virgin recruitment (R_0). Resulting profiles are presented in Figures 61-63. R_0 was well-estimated with most data sources agreeing on a value between 7.5 and 8.5 (in log space; Figure 61), with the final model estimated value being 8.215.

The steepness profiles indicated that the model favored values above 0.7, but there was not a trough at a strong minima, which indicated that steepness was not well estimated and values between 0.7 and 0.8 were more or less equally likely (Figure 62). The lowest likelihood was at a steepness value 0.777.

Similar to the profile on steepness, the response surface for σ_R did not strongly support a single value but tended to indicate values from 0.5-0.55; the minimum was at 0.52 (Figure 63).

3.2.2.6 *Retrospective Analysis*

The impact on model results from sequentially removing entire years of data was evaluated using retrospective analysis for the last four years of data, 2015-2018. The results (Figure 64) do not suggest any strong retrospective pattern. As years are removed, the model estimates of spawning stock biomass and/or fishing mortality in each successive terminal year do not change substantially, and also do not exhibit any pathological trend of over- or underestimation.

3.2.2.7 *Jitter Analysis*

A jitter analysis was conducted using a jitter value of 0.1. With this procedure, the starting model parameter values are randomly adjusted by 10% from the base model best fit. The model was able to converge to same likelihood of the base model in 94% of runs and no runs demonstrated a lower negative log-likelihood solution (Figure 65). In the few instances that the base solution was not reached (4), the catch data were often disproportionately dominating the total negative log-likelihood. Most likely this was due to difficulties estimating selectivity. Given that the total negative log-likelihood values were much higher for these runs, it is probable that non-optimal solutions were found (i.e., the model search was stuck in local minima). If priors had been placed on a few of the parameters as is often done with double normal selectivity curves and perhaps the retention inflection/width parameter for the Charter+Private fleet, it is probable that a higher percentage of jitter runs would have converged back to the base solution. However, given the consistency in parameter estimates (e.g., R_0) and the relatively few runs that performed poorly, the jitter analysis indicates that the model is relatively stable.

3.2.2.8 *Continuity Model and Model Building Runs*

The general flow of model building runs that led to the final SEDAR 70 base model is shown in Table 20. The SEDAR 33 models that used the SS3.24_S version were successfully converted to the new SS3.30 version without any issues (Step1). Key derived quantities and important parameters (e.g., S/R parameters, growth) were estimated similarly in SS3.30. Additionally, when the new revised MRIP-FES landings and discard data were substituted for the Charter+Private inputs in the 3.30 model, the estimates of initial stock size (R0) increased (Step 2). The Greater Amberjack initial stock size increased by 54% and a similar increase in recruits was predicted. Once the SEDAR 33 SS 3.24 model was successfully converted to SS 3.30 version and the new FES Charter+Private data were added (Step 2) then the work focused on adding the new data and/or revised data for the entire time series since the SEDAR 33 Update. These runs ultimately led to the final SEDAR 70 base mode (Steps 3-6) and focused on a few data changes and also additional model work including: improving the fits to the length and age compositions, exploring the spline function to model commercial vertical line length selectivity, using the Dirichlet multinomial to weight the length and age compositions, incorporating the combined video index into the assessment, and finally dropping the commercial vertical line index.

3.2.2.9 Sensitivity Model Runs

The results of three jackknife sensitivity runs are presented in Figure 66. These explorations considered the influence of individual indices. The results did not indicate that removal of any particular index had a major influence on estimates of key derived quantities. This is likely due in part to the large influence of the length and age composition data on the overall base model fit. When the commercial longline index was removed the resulting estimates of absolute F were reduced slightly and SSB in the final year was slightly increased.

The estimated parameters from the sensitivity run using the ASPIC model are shown in Table 21. Biomass and fishing mortality trajectories resulting from the ASPIC sensitivity model run are presented in Figure 67. The model results estimated stock condition since 1986. The figure shows pronounced declines of relative stock biomass in 1985-1988, 1991-1995, and 2002-2006. The periods of decline in stock biomass are associated with periods of high relative F. Further interpretations derived from this sensitivity run would require additional explorations of the model assumptions beyond the scope of this sensitivity, however, the trajectories of the ASPIC sensitivity run are consistent with the results from the SEDAR 33 base model, as well as those from the current SEDAR 70 stock assessment.

3.3. Discussion

The SEDAR 70 Greater Amberjack assessment included several important changes to data inputs and model parameterization that affected the assessment results including the following:

- 1) incorporating the MRIP-FES in estimation of recreational landings and discards
- 2) incorporation of a combined video survey index of abundance
- 3) exclusion of the commercial vertical line (Com_VL) index
- 4) weighting of commercial length data
- 5) revised commercial discard estimates

- 6) incorporation of spline function to model commercial vertical line selectivity
- 7) incorporation of an internal self-weighting distribution for fitting for length and age compositions.

The most significant of the SEDAR 33 to SEDAR 70 model changes (data or model configuration) was the revision in recreational catch and discards estimates, which ultimately led to increased estimates of productivity resulting from much higher estimated Charter+Private landings. The remaining changes did not have as large an impact on the overall assessment results and estimates of parameters (growth rate, R_0 , etc.) or key derived quantities. However, the remaining changes did lead to significant improvements in model fits and a more stable model. This was demonstrated through better gradients (and lower standard errors) in the parameter fitting process for many parameters, the elimination of bounded parameters from the previous SEDAR 33 model, and only a few parameters with correlations > 0.7 . Additionally, converting the previous SEDAR 33 SS 3.24s model to the upgraded SS 3.30 version had virtually no impact on model results but was seen as an overall improvement in the assessment as the updated SS version (3.30_15) allows even greater flexibility in handling a number of processes including projections.

The SEDAR 70 model fit most of the data sources well with no major residual patterns and the fits were much improved from SEDAR 33 Benchmark and SEDAR 33 Update. As with SEDAR 33, the dominant data inputs were the length and age compositions as these produced the greatest impact on the model fit (as measured in the total likelihood); the exclusion of single index series were generally un-informative in the evaluation. There were only a few parameters with correlations and these were of a moderate level (plus/minus 0.7 – 0.85). These correlated parameters were mainly the retention functions for the Charter+Private fleet but they did not appear to be the source of any major model stability issues. Bootstrap and jitter analyses did not indicate instability as most runs converged to the same solution space. No substantial retrospective patterns are present in the model fits, indicating internal consistency within the model. Likelihood profiles from the base model showed that steepness and σR were not well estimated though there was minimum observed likelihood for the base model estimates.

It is important to note that uncertainties remain in some components of the Greater Amberjack data series used in the assessment. The landings data are dominated by the recreational fishery, and recreational landings are more uncertain than commercial data. Additionally, before 1981, recreational data are estimated using a hindcasting procedure, and discards prior to 1981 are not quantified. Some data on the size of discarded fish are available for the Charter+Private and headboat fleets, however the sample sizes are low in many years. The SEFSC Coastal Logbook Reef fish Program (CLP) observer project provided some information on the size composition of released fish for the commercial fishery in recent years (2006-2018), however as with the recreational discard size composition the sample sizes are very low.

The SEDAR 70 Greater Amberjack assessment predicts a steady and significant decline in total biomass and spawning stock biomass and associated increasing and intense exploitation (as

measured by total exploitation rate) over the entire time series (Figure 39 and 40) with only a few brief intersessions of increasing biomass. This decline in stock condition continues through the terminal year. In the context of continuity of management advice from the SEDAR 33 Update, the SEDAR 70 model is generally consistent as indicated in Figures 39 and 40. There are some notable differences in the early part of the time series (1950-1960s) during the years of high uncertainty in catches. These differences are quite likely mostly due to lack of FES-calibrated catch data in the SEDAR 33 Update assessment. After the mid-1980s the models line up very closely, around the time when size/age information becomes available. However, the SEDAR 70 model is overall slightly more optimistic than the SEDAR 33 Update model. This could be due in part to the better and improved model fits to the length and age compositions, which are main drivers in the model. Other important factors include the combined video index, which is providing some information on both recruitment and adult stock. The SEDAR 70 combined video index predictions show a declining abundance from 2010-2015, while the fit to the two video indices in SEDAR 33 predicted a slightly increasing trend over the same period (Figure 44). The SEDAR 70 Assessment Panel thought the combined video index for the three separate surveys (SEAMAP, PC Lab, and FWRI) was a more representative index for Greater Amberjack than any of the surveys alone and that the index standardization approach was improved since the SEDAR 33 Update.

In 2016, the Bureau of Safety and Environmental Enforcement (BSEE) issued a contract to LGL Ecological Research Associates, Inc. to estimate the potential impacts to GOM Fisheries (including Greater Amberjack) due to explosive decommissioning of offshore oil and gas platforms. The study's focus was the federal waters of the Central and Western GOM, from the limit of state waters to a water depth of 300 m. A primary objective of this study was to compare study results with mortality estimates currently used in fisheries management plans or recent stock assessments, to quantify resulting differences in abundance or population estimates and determine if, and at what rate of explosive severance operations impact populations.

Preliminary results received from LGL suggest that a significant fraction (30-40%) of the total abundance of Greater Amberjack occur on oil and gas platforms in the Central and Western GOM, far larger than the fraction of other managed species (e.g., Vermilion Snapper, Red Snapper and Cobia). The results of this study could have important implications for the stock assessment and the resulting management advice, but the changes needed to restructure the model and adequate time and resources to acquire the necessary data to inform a model with the required temporal and spatial stratification were outside the scope of an Operational Assessment. The SEFSC strongly recommends further consideration of this study during the next Research Track assessment of GOM Greater Amberjack. Given the potential implications of this study, we also recommend a Research Track assessment be scheduled as soon as is feasible.

The GOM Greater Amberjack stock is undergoing overfishing and remains in an overfished state based on the definition of MSST ($0.5 * SSB_{SPR30\%}$) and MFMT for the final SEDAR 70 base model (Tables 22 and 23). Overall, the SEDAR 70 base model is improved since the SEDAR 33 Benchmark and Update assessments, and it incorporates the best available data and addressed modeling issues evident in the prior assessments.

4. Projections

4.1. Introduction

The SEDAR 70 projections were run for two key fishing mortality scenarios: $F_{SPR30\%}$ and $F_{OY} = F_{Rebuild}$. Transitioning from recreational landings estimated using the coastal household telephone survey (CHTS) to landings estimated using the fishing effort survey (FES) was expected to increase the catch recommendations relative to past assessments. Understanding the magnitude of the increase due to the landings data transition could inform a baseline from which to evaluate changes in catch limits due to changes in biomass, recruitment or productivity. Analyses aimed at quantifying the magnitude of the catch limit increase are included to aid in interpreting the catch advice and are provided herein.

4.2. Projection methods

The simulated dynamics used for projections assumed nearly identical parameter values and population dynamics as the SS base model. Table 22 provides a summary of projection settings. Projections were run assuming that relative F , selectivity, discarding, and retention associated with the most recent time period (2016-2018) would remain the same into the future. Projections also assumed that future recruitment would be derived using the mean recruitment from the last ten years of estimated recruitment (2009-2018).

Due to the lag in reporting and verification of fishery statistics, finalized landings statistics were only available through 2018. For the purpose of the projections, the average of the last 3 years of landings, by fleet, were used as interim catch for the years between the terminal assessment year (2018) and the first year of management advice (2021).

$F_{SPR 30\%}$ was determined using a long-term 100-year projection assuming that equilibrium was obtained over the last 10 years (2109-2119). For the OFL projection, the $F_{SPR 30\%}$ was applied to the stock starting in 2021 while maintaining the fleet allocations currently in place.

The minimum stock size threshold (MSST) was determined by multiplying the reference spawning stock biomass, $SSB_{SPR 30\%}$, by 0.5 (per the SEDAR 70 TORS) and was used to determine stock status. The maximum fishing mortality threshold (MFMT) was equivalent to the harvest rate ($F_{SPR 30\%}$; biomass removed / total biomass) that achieved $SSB_{SPR 30\%}$, and was used to assess whether overfishing was occurring in a given year.

Once the proxy values were calculated, 2018 stock status was used to determine whether a rebuilding plan was required (i.e., if $SSB < MSST$ then GOM Greater Amberjack would be considered overfished and a rebuilding plan would be required). Then, $F_{Rebuild}$ was calculated as the F that would rebuild the stock to the level that supports MSY, $SSB_{SPR 30\%}$ in 2027.

In addition, projections undertaken to quantify the effect of transitioning the recreational landings data were conducted using the SEDAR 33 Update model (terminal year 2015) with the recreational data updated to the new FES values for all years. Assumed 2015 removals were used during SEDAR 33 projections as landings for 2016 to provide management advice beginning in

2017. To conduct the FES projection, 2016 recreational landings set equal to observed 2015 FES data.

4.3. *Projection Results*

4.3.1. *Biological Reference Points*

The current status determination criteria (SDCs) for GOM Greater Amberjack were confirmed by GMFMC staff and SERO. Note that they differ somewhat from what appears in the SEDAR 70 TORs. The current SDCs are:

- MSY proxy = yield at $F_{SPR\ 30\%}$
- $MSST = 0.5 * SSB_{SPR\ 30\%}$
- $MFMT = F_{SPR\ 30\%}$
- $OY = 75\% F_{SPR\ 30\%}$

The harvest rate that results in SPR 30% over the long-term (100 years) was 0.175 (Table 23). The resulting SSB at SPR 30% was 7,119 metric tons and the minimum stock size threshold (MSST) was 3,559 metric tons. The MSST was calculated as $0.5 * SSB_{SPR30\%}$.

4.3.2. *Stock Status*

According to GMFMC Amendment 44, the minimum stock size threshold (MSST) for GOM Greater Amberjack is $0.5 * SSB_{SPR30\%}$. A stock is considered overfished when $SSB_{Current} < MSST$. Under this definition, GOM Greater Amberjack remains overfished ($SSB_{2018}/MSST = 0.68$; Tables 23-24). The terminal year SSB is also well below the recovery target, SSB_{SPR30} . In 2018, SSB was only 34% of the biomass level needed to support MSY ($SSB_{2018}/SSB_{SPR30} = 0.34$).

Likewise, under Amendment 44 the maximum fishing mortality threshold is $F_{SPR30\%}$. A stock is determined to be undergoing overfishing if $F_{Current} > MFMT$. $F_{Current}$ is defined as the geometric mean of the fishing mortality over the most recent three years. From 2016 to 2018 the estimated stock harvest rate, using the geometric mean, was 0.30, which was equivalent to 171% of $F_{SPR\ 30\%}$ (0.175, Tables 23 and 24).

The Kobe plot (Figure 68) indicates that over the time horizon of the assessment (i.e., 1950 - 2018), the stock has experienced overfishing since 1977 and continues to experience overfishing through the terminal (2018) year of the SEDAR 70 assessment.

As expected, prolonged overfishing reduced stock biomass below $SSB_{SPR30\%}$ from 1980 - 2018. Using the MSST definition for Greater Amberjack, the stock has been in a consistent overfished state since 1988 dipping to 37% level in 1996. Since reaching a very low level of SSB around the mid 1990's, there have been brief periods of what appeared moderate improvements in SSB followed by declines in SSB. Since around 2010, SSB has averaged 66% of MSST (Table 24).

4.3.3. *Overfishing Limits*

Projection results are provided in Tables 25-27. Forecasts begin in 2021 because management based on this stock assessment cannot begin until 2021.

Since the stock remains in an overfished state (Tables 22 and 23), a rebuilding projection was also conducted (Table 26). The current requirement under the present rebuilding schedule is to identify the F that leads to stock recovery by 2027.

Since the stock is currently below the SPR 30% target, forecasts indicate that a reduction in yield is required in the near-term in order to allow the stock to build towards the target SPR (Tables 26 and 27 and Figure 69).

4.3.4. *FES-only Projections*

Updating the SEDAR 33 Update base model with the FES recreational landings resulted in as expected increased estimate of virgin spawning stock biomass, recruitment, and projected yields (Table 28). With the introduction of FES data, the SEDAR33 virgin spawning stock biomass estimate increased by 54% and the average recent (2010 – 2015) SSB and recruitment estimates increased by 53% and 65%, respectively (Table 28). Estimates of stock productivity were also affected, with the original SEDAR 33 Update model estimating $\ln(R0) = 6.94$ and the FES adjusted model estimating $\ln(R0) = 8.4$. The models fit using FES data estimated a population that was both more abundant and more productive than previously estimated in SEDAR 33 which when carried forward into the projections resulted in predictable increases to the sustainable yield estimates.

4.4. *Discussion*

Overall the main stock assessment results of the SEDAR 70 update model were similar to the SEDAR 33 Benchmark and SEDAR 33 Update assessments. The SS model from the SEDAR 33 Update was successfully converted to the new SS 3.30 model.

The SEDAR 70 model fits to the length and age compositions were much improved from the SEDAR 33 assessment as measured by much lower Pearson residuals, reduced banding across many of the individual fleet/year/ strata, very few parameters correlated and low correlations in general, and no bounded parameters. Some of the improvement was due to exploring the spline selectivity function for the commercial vertical line fleet and also not implementing tail compression for the length compositions fits.

The results of the jitter analysis for the update model were improved from those of the Benchmark assessment with the update model appearing more stable than the previous Benchmark assessment. Further, estimation of several parameters, notably some of the selectivity and retention parameters, was improved in the SEDAR 70 assessment as supported through generally lower standard errors and fewer parameters with correlations $> .9$. Retrospective model results for the update model suggested no strong retrospective patterns were evident.

In addition, the retrospective results for the update model indicate that the management advice with respect to SSB and stock status is quite consistent with the SEDAR 33 Benchmark assessment. The Update model predicts the Greater Amberjack stock is still overfished and undergoing overfishing as predicted by the SEDAR 33 Benchmark assessment.

The SEDAR 70 assessment was somewhat more optimistic with regard to stock status, as it produced higher estimates of SSB/SSB_{SPR 30%} and lower estimates of F/F_{SPR 30%} in the most recent years.

The updated commercial CPUE indices suggested a change in catchability around 2009 however practically speaking no definitive explanation is available. The opposite trend in CPUE was predicted for the longline fleet.

5. Acknowledgements

The SEDAR 70 Greater Amberjack Operational stock assessment was conducted through the collaborative efforts of numerous fisheries experts across multiple agencies. The following agencies contributed to the assessment and deserve notable attention and thanks for efforts extended to update data and clarify a variety of questions relating to updating the data inputs: NOAA, SEFSC, Fisheries Statistics Division (FSD); SEFSC, Panama City Laboratory, SEFSC Galveston Laboratory; SEFSC, Beaufort Laboratory; Florida Fish and Wildlife Commission, University of Florida, Gulf States Marine Fisheries Commission. The document was improved through the internal SEFSC, Sustainable Fisheries editorial review process. Special thanks are extended to Drs. Richard Methot and Ian Taylor for continued discussions on application of the Stock Synthesis model and in particular on changes from the SS3.24_S to SS3.30_15 version. Thanks are extended to Skyler Sagarese for developing R code to implement the Markdown versions of the majority of the tables and figures.

6. Research Recommendations

Recommendations for considerations of future research are provided below and do not indicate any particular order of priority.

Life History

Develop improved estimates of maturity ogives and develop fecundity estimates for use model work

Landings and Discards

- Expand commercial fishery observer coverage and in particular focus on better quantifying retained fish out of season
- Increase sampling of length and age composition data from both commercial and recreational landings in particular for discarded fish
- Quantify and evaluate appropriate weighting procedures of length and age compositions at finer spatial and temporal scales (e.g., quarterly/state/sub-region strata)

- Characterize imputations in MRIP statistics at finer level (e.g., identify round of imputation)

Fishery Independent Indices

- SEAMAP Ichthyoplankton Surveys:

At this time, no larval abundance index for Greater Amberjack is available. *Seriola* spp. larvae are taken in both bongo and neuston nets during SEAMAP surveys. At the time of the SEDAR 33 assessment, there are at least 3,500 specimens initially identified as *Seriola* spp., however these specimens will have to be re-examined to verify identification. This task should be accomplished prior to next Benchmark/research track.

Fishery Dependent Indices

- Investigate options for developing fishery-dependent surveys that better reflecting abundance of Greater Amberjack from dependent fisheries with particular focus on impact on index development from other fishery regulatory measures
- Investigate appropriateness of use of design-based estimator for Coastal Logbook Program given that a survey design is not in use for the fisher reported logbook data

7. References

- Diaz, G. A., C. E. Porch, and M. Ortiz. 2004. Growth models for red snapper in U.S. Gulf of Mexico waters estimated from landings with minimum size limits restrictions. Southeast Fisheries Science Center, Sustainable Fisheries Division Contribution: SFD-2004-038. Miami, Florida.
- Foster, J. and F.J. Breidt. 2018. APAIS data calibration methodology report. 10 p. Available at: <https://www.fisheries.noaa.gov/event/access-point-angler-intercept-survey-calibration-workshop>
- Francis, R.I.C.C. 2011. Data weighting in statistical fisheries stock assessment models. *Canadian Journal of Fisheries and Aquatic Sciences* 68: 1124-1138.
- Gallaway, F. B., R.T. Beyea, K. McCain, and W. Heyman. 2019. Explosive removal of structures: Fisheries impact Assessment: Field Season 2 assemblage characterization report. Technical Report. 75pp.
- GMFMC 2008. Final Reef Fish Amendment 30A: Greater Amberjack - Revise rebuilding plan, accountability measures. Gray Triggerfish - Establish rebuilding plan, end overfishing, accountability measures, regional management, management thresholds and benchmarks. Including Supplemental Environmental Impact Statement, Regulatory Impact Review, and Regulatory Flexibility Act Analysis. February 2008. 346 p. Available online at: <http://gulfcouncil.org/docs/amendments/Amend-30A-Final%202008.pdf>.
- Lorenzen, K. 1996. The relationship between body weight and natural mortality in juvenile and adult fish: a comparison of natural ecosystems and aquaculture. *Journal of Fish Biology*, 49: 627-647.
- MacAllister, M., and Ianelli, J. 1997. Bayesian stock assessment using catch-age data and the sampling-importance resampling algorithm. *Canadian Journal of Fisheries and Aquatic Sciences*, 54: 284-300.
- Maunder, M., and Punt, A. 2013. A review of integrated analysis in fisheries stock assessment. *Fisheries Research*, 142: 61-74.
- Methot, R., Wetzel, C., Taylor, I., and Doering, K. 2019. Stock Synthesis User Manual Version 3.30.14. NOAA Fisheries. Seattle, WA.
- Methot, R., and Wetzel, C. 2013. Stock Synthesis: a biological and statistical framework for fish stock assessment and fishery management. *Fisheries Research*, 142: 86-99.
- NOAA Fisheries. 2018. Marine Recreational Information Program Transition Plan for the Fishing Effort Survey. 34 p. Available at: <https://www.fisheries.noaa.gov/event/fishing-effort-survey-calibration-model-peer-review>.
- Prager, M.H. 2016. User's Guide for ASPIC Suite, version 7: A Stock-Production Model Incorporating Covariates and auxiliary programs. Prager Consulting. Portland, OR.
- Prager, M. H. 1994. A suite of extensions to a nonequilibrium surplus-production model. *Fishery Bulletin* 92: 374-389.
- Rago, P.J., A. Arab, R.L. Hicks, C.M. Jones, J. McNamee, F.M. Serchuk, and P.J. Sullivan. 2017.
- Summary Report Marine Recreational Information Program (MRIP) Fishing Effort Survey (FES) Calibration Review. 34 p. Available at: <https://www.fisheries.noaa.gov/event/fishing-effort-survey-calibration-model-peer-review>.
- Stephens, A., and MacCall, A. 2004. A multispecies approach to subsetting logbook data for purposes of estimating CPUE. *Fisheries Research*, 70: 299-310.

8. Tables

Table 1. Length-weight function used to convert fork length in centimeters of Gulf of Mexico Greater Amberjack to weight in kilograms. Units are whole weight (kg) and FL (cm).

Sex	Model	N	FL range	RSE
Combined Males and Females	$WW = 7.046 \times 10^{-05}(FL^{2.633})$	1,865	7.4 – 182.9	1.019

Table 2. Age-specific natural mortality (per year) for the base model for Gulf of Mexico Greater Amberjack based on the Lorenzen method for all data combined.

Age	Scaled Lorenzen base (/year)
0	0.740
1	0.516
2	0.417
3	0.362
4	0.328
5	0.305
6	0.289
7	0.278
8	0.269
9	0.263
10	0.258

Table 3. Growth parameters recommended for Gulf of Mexico Greater Amberjack.

Parameter	All
L_{∞} (mm)	1307.066
K	0.230
t_0	-0.757

Table 4. Gulf of Mexico Greater Amberjack commercial landings in pounds whole weight.
[* denotes confidential data.]

Year	Vertical line	Longline	Other
1963	8,430	-	-
1964	6,114	-	185
1965	5,187	-	-
1966	7,318	-	-
1967	28,901	-	-
1968	11,394	-	-
1969	72,161	-	-
1970	13,061	-	463
1971	38,072	-	-
1972	*	-	*
1973	*	-	*
1974	*	-	*
1975	*	-	*
1976	*	-	*
1977	110,303	-	8,355
1978	147,684	-	1,464
1979	144,853	2,687	2,391
1980	167,785	4,706	4,092
1981	209,705	22,223	811
1982	182,206	38,829	648
1983	230,871	45,110	93
1984	462,522	61,062	61
1985	640,835	113,246	7,565
1986	919,241	209,489	749
1987	1,279,706	259,532	22,143
1988	1,699,691	339,898	37,767
1989	1,613,597	312,113	43,041
1990	980,834	115,465	168,365
1991	1,548,985	6,329	227,620
1992	959,935	52,837	49,997
1993	1,428,980	84,254	110,709
1994	1,128,590	69,634	89,178

Table 4 Continued. Gulf of Mexico Greater Amberjack commercial landings in pounds whole weight.

Year	Vertical line	Longline	Other
1995	1,127,102	81,832	34,316
1996	1,123,341	55,927	67,172
1997	991,828	55,876	21,758
1998	587,757	50,060	17,988
1999	619,254	57,620	51,567
2000	728,555	63,344	58,638
2001	620,802	43,315	42,288
2002	655,955	74,602	38,384
2003	818,695	114,082	27,775
2004	835,605	77,762	37,681
2005	619,435	68,991	28,744
2006	492,274	72,282	27,391
2007	514,346	57,581	15,938
2008	361,525	86,606	20,728
2009	531,941	48,156	14,736
2010	503,286	21,519	29,705
2011	489,886	10,698	18,980
2012	287,914	9,341	17,910
2013	439,228	15,862	16,211
2014	472,371	20,597	39,064
2015	441,733	27,068	31,812
2016	437,123	22,378	19,044
2017	415,833	20,145	48,046
2018	249,942	12,053	63,550

Table 5. Gulf of Mexico Greater Amberjack recreational landings in numbers.

Year	Charter	Private	Headboat
1981	11,050	316,830	7,773
1982	501,872	394,232	7,773
1983	331,811	150,933	7,773
1984	86,330	68,719	7,773
1985	161,389	409,128	7,773
1986	331,775	157,931	86,024
1987	395,462	911,135	52,892
1988	196,553	132,835	29,660
1989	149,024	324,943	52,521
1990	24,322	64,810	24,260
1991	296,258	37,117	9,852
1992	308,211	71,016	19,747
1993	96,495	99,953	14,053
1994	83,921	50,272	13,116
1995	10,515	44,787	8,670
1996	62,719	74,917	10,511
1997	32,250	37,876	7,538
1998	22,880	45,230	5,110
1999	38,485	84,761	5,286
2000	32,322	66,739	6,000
2001	24,498	89,246	6,009
2002	69,857	164,909	10,689
2003	71,242	244,466	11,976
2004	55,322	191,113	6,242
2005	21,837	195,411	3,993
2006	42,860	91,204	4,726
2007	30,563	38,114	4,462
2008	26,033	116,107	4,823
2009	32,296	79,875	5,239
2010	21,496	128,270	2,571
2011	34,545	78,018	2,992
2012	25,984	123,117	3,836
2013	25,287	106,452	3,130

Table 5 Continued. Gulf of Mexico Greater Amberjack recreational landings in numbers.

Year	Charter	Private	Headboat
2014	19,702	118,655	1,994
2015	40,268	80,926	2,866
2016	24,528	85,079	1,102
2017	4,560	35,270	918
2018	23,108	63,370	2,456

Table 6. Gulf of Mexico Greater Amberjack commercial discards in numbers.

Year	Vertical Line	Longline
1993	30,176	621
1994	30,626	799
1995	37,452	885
1996	38,850	873
1997	38,214	963
1998	32,712	1,937
1999	42,349	2,254
2000	33,294	2,885
2001	36,398	1,404
2002	31,648	1,822
2003	35,689	2,619
2004	36,325	2,745
2005	27,016	2,777
2006	22,090	2,073
2007	21,744	1,260
2008	19,542	1,632
2009	23,102	1,206
2010	11,229	614
2011	15,288	784
2012	11,353	349
2013	13,325	646
2014	16,361	940
2015	12,920	1,074
2016	17,088	1,099
2017	14,797	991
2018	8,563	597

Table 7. Gulf of Mexico Greater Amberjack recreational discards in numbers.

Year	Charter	Private	Headboat
1981	11	38,119	5
1982	14,616	73,341	155
1983	26,354	135,732	421
1984	0	33,864	-
1985	22	43,565	1
1986	80,303	30,616	14,212
1987	3,295	69,484	301
1988	722	119,166	74
1989	7,690	165,006	1,850
1990	39,086	146,518	26,612
1991	301,272	47,291	6,839
1992	174,641	147,669	7,638
1993	132,512	189,161	13,173
1994	66,897	115,718	7,137
1995	6,652	112,832	3,744
1996	37,407	42,155	4,279
1997	18,843	111,222	3,006
1998	47,860	148,362	7,296
1999	62,975	160,105	5,904
2000	29,358	310,989	3,720
2001	53,698	1,439,225	8,991
2002	78,743	669,897	8,224
2003	60,221	604,539	6,910
2004	25,708	360,666	1,980
2005	20,450	522,785	2,552
2006	23,781	484,217	1,790
2007	33,803	294,674	3,369
2008	58,018	311,353	4,637
2009	57,881	209,893	5,619
2010	33,583	1,029,681	2,981
2011	46,164	643,868	3,107
2012	27,996	342,880	3,834
2013	48,927	654,413	4,665

Table 7 Continued. Gulf of Mexico Greater Amberjack recreational discards in numbers.

Year	Charter	Private	Headboat
2014	82,209	340,530	5,750
2015	69,716	446,255	8,235
2016	80,406	592,754	7,500
2017	74,958	467,838	4,484
2018	39,454	265,951	3,499

Table 8. Standardized indices of relative abundance and associated log-scale standard errors for Gulf of Mexico Greater Amberjack.

Year	CommLL CPUE	CommLL SE	Headboat CPUE	Headboat SE	CH-PR CPUE	CH-PR SE	Joint Video CPUE	Joint Video SE
1986			3.768	0.322	3.297	0.286		
1987			1.899	0.351	2.393	0.309		
1988			2.019	0.341	0.773	0.363		
1989			1.528	0.354	1.815	0.349		
1990	0.531	0.394	0.631	0.415	0.197	0.485		
1991	0.791	0.299	0.742	0.396	1.952	0.333		
1992	1.438	0.315	1.265	0.356	1.834	0.286		
1993	0.564	0.270	0.762	0.368	0.656	0.355	0.621	0.277
1994	0.373	0.265	0.605	0.386	0.564	0.366	1.200	0.549
1995	0.582	0.269	0.713	0.380	0.498	0.409	0.738	0.286
1996	0.524	0.292	0.819	0.372	0.355	0.398	0.642	0.237
1997	0.587	0.261	0.630	0.406	0.390	0.382	1.011	0.654
1998	0.586	0.268	0.431	0.425	0.237	0.357		
1999	0.574	0.263	0.566	0.448	0.237	0.337		
2000	0.601	0.268	0.564	0.438	0.541	0.333		
2001	0.731	0.257	0.952	0.391	1.244	0.297		
2002	1.003	0.254	1.091	0.403	1.291	0.279	2.295	0.218
2003	1.060	0.242	1.476	0.382	1.216	0.279		
2004	1.342	0.254	1.134	0.379	0.787	0.291	0.788	0.239
2005	1.817	0.248	0.521	0.429	0.798	0.309	1.097	0.224
2006	1.319	0.250	0.716	0.434	0.631	0.332	0.744	0.190
2007	0.974	0.265	0.430	0.442	0.812	0.321	0.972	0.218
2008	1.470	0.253	1.464	0.451	0.688	0.316	0.922	0.248
2009	2.044	0.265	0.770	0.402	0.918	0.314	1.336	0.167
2010	1.825	0.347					0.756	0.213
2011	0.830	0.363	0.896	0.485	1.315	0.319	0.919	0.189
2012	1.426	0.531	0.788	0.483	0.916	0.323	1.150	0.154
2013	1.912	0.471	0.716	0.480	0.926	0.323	1.103	0.199
2014	0.455	0.346	0.491	0.550	0.555	0.358	1.183	0.226
2015	1.192	0.331	0.611	0.441	1.163	0.301	0.974	0.151
2016	1.100	0.311					1.037	0.368
2017	0.750	0.358					0.765	0.159
2018	0.603	0.448					0.745	0.315

Table 9. List of Stock Synthesis parameters for Gulf of Mexico Greater Amberjack. The list includes predicted parameter values, lower and upper bounds of the parameters, associated standard deviations and coefficients of variation, the prior type and densities (value, SD) assigned to the parameters as applicable, and phases (negative identifies parameters that were fixed). Parameters designated as fixed were held at their initial values and have no associated range or SD.

Label	Value	Range	SD	CV	Prior	Phase
L_at_Amin_Fem_GP_1	13.906	(10,50)			Normal (32,20)	-6
L_at_Amax_Fem_GP_1	130.706	(100,160)			Normal (130.706,20)	-5
VonBert_K_Fem_GP_1	0.226	(0.1,0.4)	0.003	0.013		6
CV_young_Fem_GP_1	0.200	(0.05,0.3)				-8
CV_old_Fem_GP_1	0.200	(0.05,0.3)				-8
Wtlen_1_Fem_GP_1	0.000	(0.1,0.5)				-2
Wtlen_2_Fem_GP_1	2.633	(2,4)				-2
Mat50%_Fem_GP_1	82.700	(70,100)				-3
Mat_slope_Fem_GP_1	-0.100	(-1,0)				-3
Eggs/kg_inter_Fem_GP_1	1.000	(-3,3)				-3
Eggs/kg_slope_wt_Fem_GP_1	0.000	(-3,3)				-3
RecrDist_GP_1	0.000	(0,0)				-4
RecrDist_Area_1	0.000	(0,0)				-4
RecrDist_month_1	0.000	(0,0)				-4
CohortGrowDev	1.000	(0.1,10)			Normal (1,1)	-1
FracFemale_GP_1	0.500	(1e-06,0.999999)				-99
SR_LN(R0)	8.215	(4,20)	0.067	0.008		1
SR_BH_steep	0.777	(0.2,0.99)				-2
SR_sigmaR	0.524	(0,2)				-4
SR_regime	0.000	(-5,5)				-1
SR_autocorr	0.000	(0,0.5)				-4
SR_regime_BLK4add_1949	0.000	(-5,5)	0.188	1076.772	Normal (0,2.5)	4
Early_RecrDev_1970	0.009	(-5,5)	0.522	55.734		6
Early_RecrDev_1971	0.012	(-5,5)	0.522	43.745		6
Early_RecrDev_1972	0.014	(-5,5)	0.52	37.855		6
Early_RecrDev_1973	0.013	(-5,5)	0.517	38.831		6
Early_RecrDev_1974	0.004	(-5,5)	0.512	120.808		6
Early_RecrDev_1975	-0.015	(-5,5)	0.504	-33.546		6

Table 9 Continued. List of Stock Synthesis parameters for Gulf of Mexico Greater Amberjack.

Label	Value	Range	SD	CV	Prior	Phase
Early_RecrDev_1976	-0.043	(-5,5)	0.495	-11.63		6
Early_RecrDev_1977	-0.092	(-5,5)	0.483	-5.252		6
Early_RecrDev_1978	-0.129	(-5,5)	0.47	-3.656		6
Early_RecrDev_1979	-0.059	(-5,5)	0.452	-7.71		6
Early_RecrDev_1980	0.178	(-5,5)	0.358	2.006		6
Early_RecrDev_1981	-0.077	(-5,5)	0.396	-5.147		6
Early_RecrDev_1982	0.291	(-5,5)	0.358	1.229		6
Early_RecrDev_1983	0.700	(-5,5)	0.306	0.437		6
Main_RecrDev_1984	-0.070	(-5,5)	0.391	-5.598		3
Main_RecrDev_1985	0.924	(-5,5)	0.239	0.259		3
Main_RecrDev_1986	0.251	(-5,5)	0.27	1.078		3
Main_RecrDev_1987	-0.439	(-5,5)	0.327	-0.745		3
Main_RecrDev_1988	1.039	(-5,5)	0.192	0.185		3
Main_RecrDev_1989	0.428	(-5,5)	0.271	0.633		3
Main_RecrDev_1990	-0.520	(-5,5)	0.346	-0.665		3
Main_RecrDev_1991	-0.206	(-5,5)	0.204	-0.989		3
Main_RecrDev_1992	-0.547	(-5,5)	0.213	-0.389		3
Main_RecrDev_1993	-0.235	(-5,5)	0.185	-0.789		3
Main_RecrDev_1994	-0.327	(-5,5)	0.222	-0.679		3
Main_RecrDev_1995	-0.529	(-5,5)	0.248	-0.468		3
Main_RecrDev_1996	0.001	(-5,5)	0.194	204.384		3
Main_RecrDev_1997	0.255	(-5,5)	0.172	0.673		3
Main_RecrDev_1998	-0.200	(-5,5)	0.204	-1.022		3
Main_RecrDev_1999	0.844	(-5,5)	0.127	0.15		3
Main_RecrDev_2000	0.936	(-5,5)	0.115	0.123		3
Main_RecrDev_2001	0.249	(-5,5)	0.144	0.579		3
Main_RecrDev_2002	-0.151	(-5,5)	0.147	-0.976		3
Main_RecrDev_2003	0.043	(-5,5)	0.115	2.658		3
Main_RecrDev_2004	-0.504	(-5,5)	0.125	-0.248		3
Main_RecrDev_2005	-0.205	(-5,5)	0.107	-0.522		3
Main_RecrDev_2006	0.420	(-5,5)	0.097	0.231		3
Main_RecrDev_2007	0.384	(-5,5)	0.097	0.252		3
Main_RecrDev_2008	0.451	(-5,5)	0.086	0.191		3

Table 9 Continued. List of Stock Synthesis parameters for Gulf of Mexico Greater Amberjack.

Label	Value	Range	SD	CV	Prior	Phase
Main_RecrDev_2009	0.009	(-5,5)	0.09	10.114		3
Main_RecrDev_2010	-0.467	(-5,5)	0.102	-0.218		3
Main_RecrDev_2011	0.053	(-5,5)	0.09	1.713		3
Main_RecrDev_2012	0.057	(-5,5)	0.093	1.625		3
Main_RecrDev_2013	-0.194	(-5,5)	0.114	-0.589		3
Main_RecrDev_2014	0.188	(-5,5)	0.125	0.666		3
Main_RecrDev_2015	-0.599	(-5,5)	0.225	-0.376		3
Main_RecrDev_2016	-0.660	(-5,5)	0.266	-0.403		3
Main_RecrDev_2017	-0.488	(-5,5)	0.318	-0.651		3
Main_RecrDev_2018	-0.191	(-5,5)	0.448	-2.344		3
InitF_seas_1_flt_3Charter_Private_3	0.020	(0,0.1)	0.007	0.35		1
InitF_seas_1_flt_4Headboat_4	0.009	(0,0.1)	0.003	0.325		1
F_fleet_1_YR_1963_s_1	0.000	(0,3)	0	0		1
F_fleet_1_YR_1964_s_1	0.000	(0,3)	0	0		1
F_fleet_1_YR_1965_s_1	0.000	(0,3)	0	0		1
F_fleet_1_YR_1966_s_1	0.000	(0,3)	0	0		1
F_fleet_1_YR_1967_s_1	0.002	(0,3)	0	0		1
F_fleet_1_YR_1968_s_1	0.001	(0,3)	0	0		1
F_fleet_1_YR_1969_s_1	0.004	(0,3)	0.001	0.225		1
F_fleet_1_YR_1970_s_1	0.001	(0,3)	0	0		1
F_fleet_1_YR_1971_s_1	0.002	(0,3)	0	0		1
F_fleet_1_YR_1972_s_1	0.003	(0,3)	0.001	0.38		1
F_fleet_1_YR_1973_s_1	0.002	(0,3)	0	0		1
F_fleet_1_YR_1974_s_1	0.003	(0,3)	0.001	0.339		1
F_fleet_1_YR_1975_s_1	0.006	(0,3)	0.002	0.35		1
F_fleet_1_YR_1976_s_1	0.007	(0,3)	0.002	0.303		1
F_fleet_1_YR_1977_s_1	0.010	(0,3)	0.003	0.311		1
F_fleet_1_YR_1978_s_1	0.013	(0,3)	0.005	0.381		1
F_fleet_1_YR_1979_s_1	0.014	(0,3)	0.005	0.348		1
F_fleet_1_YR_1980_s_1	0.019	(0,3)	0.007	0.363		1
F_fleet_1_YR_1981_s_1	0.026	(0,3)	0.009	0.342		1
F_fleet_1_YR_1982_s_1	0.027	(0,3)	0.008	0.291		1
F_fleet_1_YR_1983_s_1	0.047	(0,3)	0.014	0.295		1

Table 9 Continued. List of Stock Synthesis parameters for Gulf of Mexico Greater Amberjack.

Label	Value	Range	SD	CV	Prior	Phase
F_fleet_1_YR_1984_s_1	0.100	(0,3)	0.03	0.301		1
F_fleet_1_YR_1985_s_1	0.115	(0,3)	0.03	0.261		1
F_fleet_1_YR_1986_s_1	0.150	(0,3)	0.033	0.219		1
F_fleet_1_YR_1987_s_1	0.268	(0,3)	0.055	0.206		1
F_fleet_1_YR_1988_s_1	0.482	(0,3)	0.101	0.209		1
F_fleet_1_YR_1989_s_1	0.563	(0,3)	0.119	0.212		1
F_fleet_1_YR_1990_s_1	0.639	(0,3)	0.159	0.249		1
F_fleet_1_YR_1991_s_1	0.675	(0,3)	0.126	0.187		1
F_fleet_1_YR_1992_s_1	0.298	(0,3)	0.047	0.158		1
F_fleet_1_YR_1993_s_1	0.569	(0,3)	0.083	0.146		1
F_fleet_1_YR_1994_s_1	0.673	(0,3)	0.102	0.152		1
F_fleet_1_YR_1995_s_1	0.744	(0,3)	0.115	0.155		1
F_fleet_1_YR_1996_s_1	0.720	(0,3)	0.115	0.16		1
F_fleet_1_YR_1997_s_1	0.589	(0,3)	0.095	0.161		1
F_fleet_1_YR_1998_s_1	0.358	(0,3)	0.059	0.165		1
F_fleet_1_YR_1999_s_1	0.385	(0,3)	0.064	0.166		1
F_fleet_1_YR_2000_s_1	0.382	(0,3)	0.061	0.16		1
F_fleet_1_YR_2001_s_1	0.284	(0,3)	0.045	0.158		1
F_fleet_1_YR_2002_s_1	0.245	(0,3)	0.039	0.159		1
F_fleet_1_YR_2003_s_1	0.249	(0,3)	0.039	0.157		1
F_fleet_1_YR_2004_s_1	0.266	(0,3)	0.042	0.158		1
F_fleet_1_YR_2005_s_1	0.252	(0,3)	0.04	0.159		1
F_fleet_1_YR_2006_s_1	0.260	(0,3)	0.041	0.158		1
F_fleet_1_YR_2007_s_1	0.282	(0,3)	0.043	0.153		1
F_fleet_1_YR_2008_s_1	0.176	(0,3)	0.027	0.153		1
F_fleet_1_YR_2009_s_1	0.194	(0,3)	0.029	0.15		1
F_fleet_1_YR_2010_s_1	0.162	(0,3)	0.023	0.142		1
F_fleet_1_YR_2011_s_1	0.180	(0,3)	0.025	0.139		1
F_fleet_1_YR_2012_s_1	0.102	(0,3)	0.014	0.137		1
F_fleet_1_YR_2013_s_1	0.166	(0,3)	0.023	0.138		1
F_fleet_1_YR_2014_s_1	0.210	(0,3)	0.03	0.143		1
F_fleet_1_YR_2015_s_1	0.183	(0,3)	0.026	0.142		1
F_fleet_1_YR_2016_s_1	0.180	(0,3)	0.028	0.156		1

Table 9 Continued. List of Stock Synthesis parameters for Gulf of Mexico Greater Amberjack.

Label	Value	Range	SD	CV	Prior	Phase
F_fleet_1_YR_2017_s_1	0.167	(0,3)	0.028	0.168		1
F_fleet_1_YR_2018_s_1	0.098	(0,3)	0.018	0.184		1
F_fleet_2_YR_1964_s_1	0.000	(0,3)	0	0		1
F_fleet_2_YR_1970_s_1	0.000	(0,3)	0	0		1
F_fleet_2_YR_1972_s_1	0.000	(0,3)	0	0		1
F_fleet_2_YR_1973_s_1	0.000	(0,3)	0	0		1
F_fleet_2_YR_1974_s_1	0.000	(0,3)	0	0		1
F_fleet_2_YR_1975_s_1	0.000	(0,3)	0	0		1
F_fleet_2_YR_1976_s_1	0.000	(0,3)	0	0		1
F_fleet_2_YR_1977_s_1	0.000	(0,3)	0	0		1
F_fleet_2_YR_1978_s_1	0.000	(0,3)	0	0		1
F_fleet_2_YR_1979_s_1	0.000	(0,3)	0	0		1
F_fleet_2_YR_1980_s_1	0.001	(0,3)	0	0		1
F_fleet_2_YR_1981_s_1	0.003	(0,3)	0.001	0.325		1
F_fleet_2_YR_1982_s_1	0.007	(0,3)	0.002	0.303		1
F_fleet_2_YR_1983_s_1	0.011	(0,3)	0.004	0.367		1
F_fleet_2_YR_1984_s_1	0.017	(0,3)	0.006	0.355		1
F_fleet_2_YR_1985_s_1	0.029	(0,3)	0.009	0.308		1
F_fleet_2_YR_1986_s_1	0.052	(0,3)	0.015	0.286		1
F_fleet_2_YR_1987_s_1	0.083	(0,3)	0.022	0.266		1
F_fleet_2_YR_1988_s_1	0.155	(0,3)	0.043	0.277		1
F_fleet_2_YR_1989_s_1	0.186	(0,3)	0.052	0.279		1
F_fleet_2_YR_1990_s_1	0.151	(0,3)	0.045	0.298		1
F_fleet_2_YR_1991_s_1	0.029	(0,3)	0.007	0.245		1
F_fleet_2_YR_1992_s_1	0.035	(0,3)	0.007	0.197		1
F_fleet_2_YR_1993_s_1	0.058	(0,3)	0.011	0.189		1
F_fleet_2_YR_1994_s_1	0.071	(0,3)	0.014	0.196		1
F_fleet_2_YR_1995_s_1	0.088	(0,3)	0.018	0.204		1
F_fleet_2_YR_1996_s_1	0.066	(0,3)	0.014	0.212		1
F_fleet_2_YR_1997_s_1	0.059	(0,3)	0.013	0.22		1
F_fleet_2_YR_1998_s_1	0.052	(0,3)	0.011	0.213		1
F_fleet_2_YR_1999_s_1	0.063	(0,3)	0.014	0.222		1
F_fleet_2_YR_2000_s_1	0.064	(0,3)	0.014	0.219		1

Table 9 Continued. List of Stock Synthesis parameters for Gulf of Mexico Greater Amberjack.

Label	Value	Range	SD	CV	Prior	Phase
F_fleet_2_YR_2001_s_1	0.037	(0,3)	0.008	0.215		1
F_fleet_2_YR_2002_s_1	0.052	(0,3)	0.011	0.21		1
F_fleet_2_YR_2003_s_1	0.068	(0,3)	0.014	0.207		1
F_fleet_2_YR_2004_s_1	0.047	(0,3)	0.009	0.192		1
F_fleet_2_YR_2005_s_1	0.048	(0,3)	0.009	0.187		1
F_fleet_2_YR_2006_s_1	0.065	(0,3)	0.013	0.2		1
F_fleet_2_YR_2007_s_1	0.054	(0,3)	0.011	0.203		1
F_fleet_2_YR_2008_s_1	0.076	(0,3)	0.015	0.197		1
F_fleet_2_YR_2009_s_1	0.034	(0,3)	0.007	0.206		1
F_fleet_2_YR_2010_s_1	0.015	(0,3)	0.003	0.206		1
F_fleet_2_YR_2011_s_1	0.007	(0,3)	0.001	0.138		1
F_fleet_2_YR_2012_s_1	0.006	(0,3)	0.001	0.165		1
F_fleet_2_YR_2013_s_1	0.010	(0,3)	0.002	0.206		1
F_fleet_2_YR_2014_s_1	0.016	(0,3)	0.003	0.186		1
F_fleet_2_YR_2015_s_1	0.020	(0,3)	0.004	0.202		1
F_fleet_2_YR_2016_s_1	0.015	(0,3)	0.003	0.194		1
F_fleet_2_YR_2017_s_1	0.016	(0,3)	0.003	0.186		1
F_fleet_2_YR_2018_s_1	0.014	(0,3)	0.003	0.217		1
F_fleet_3_YR_1950_s_1	0.042	(0,3)	0.015	0.358		1
F_fleet_3_YR_1951_s_1	0.051	(0,3)	0.017	0.333		1
F_fleet_3_YR_1952_s_1	0.061	(0,3)	0.019	0.314		1
F_fleet_3_YR_1953_s_1	0.070	(0,3)	0.022	0.312		1
F_fleet_3_YR_1954_s_1	0.081	(0,3)	0.025	0.309		1
F_fleet_3_YR_1955_s_1	0.092	(0,3)	0.028	0.305		1
F_fleet_3_YR_1956_s_1	0.100	(0,3)	0.03	0.301		1
F_fleet_3_YR_1957_s_1	0.108	(0,3)	0.032	0.297		1
F_fleet_3_YR_1958_s_1	0.116	(0,3)	0.035	0.301		1
F_fleet_3_YR_1959_s_1	0.125	(0,3)	0.037	0.296		1
F_fleet_3_YR_1960_s_1	0.134	(0,3)	0.04	0.299		1
F_fleet_3_YR_1961_s_1	0.137	(0,3)	0.041	0.3		1
F_fleet_3_YR_1962_s_1	0.139	(0,3)	0.042	0.301		1
F_fleet_3_YR_1963_s_1	0.142	(0,3)	0.043	0.304		1
F_fleet_3_YR_1964_s_1	0.144	(0,3)	0.044	0.306		1

Table 9 Continued. List of Stock Synthesis parameters for Gulf of Mexico Greater Amberjack.

Label	Value	Range	SD	CV	Prior	Phase
F_fleet_3_YR_1965_s_1	0.146	(0,3)	0.044	0.302		1
F_fleet_3_YR_1966_s_1	0.151	(0,3)	0.046	0.305		1
F_fleet_3_YR_1967_s_1	0.156	(0,3)	0.048	0.307		1
F_fleet_3_YR_1968_s_1	0.162	(0,3)	0.05	0.309		1
F_fleet_3_YR_1969_s_1	0.168	(0,3)	0.051	0.304		1
F_fleet_3_YR_1970_s_1	0.174	(0,3)	0.053	0.305		1
F_fleet_3_YR_1971_s_1	0.182	(0,3)	0.058	0.319		1
F_fleet_3_YR_1972_s_1	0.191	(0,3)	0.068	0.357		1
F_fleet_3_YR_1973_s_1	0.200	(0,3)	0.076	0.381		1
F_fleet_3_YR_1974_s_1	0.209	(0,3)	0.082	0.392		1
F_fleet_3_YR_1975_s_1	0.220	(0,3)	0.086	0.391		1
F_fleet_3_YR_1976_s_1	0.240	(0,3)	0.093	0.388		1
F_fleet_3_YR_1977_s_1	0.265	(0,3)	0.101	0.381		1
F_fleet_3_YR_1978_s_1	0.299	(0,3)	0.111	0.372		1
F_fleet_3_YR_1979_s_1	0.344	(0,3)	0.125	0.363		1
F_fleet_3_YR_1980_s_1	0.398	(0,3)	0.138	0.346		1
F_fleet_3_YR_1981_s_1	0.276	(0,3)	0.073	0.265		1
F_fleet_3_YR_1982_s_1	0.757	(0,3)	0.182	0.24		1
F_fleet_3_YR_1983_s_1	0.660	(0,3)	0.183	0.277		1
F_fleet_3_YR_1984_s_1	0.152	(0,3)	0.039	0.257		1
F_fleet_3_YR_1985_s_1	0.331	(0,3)	0.073	0.221		1
F_fleet_3_YR_1986_s_1	0.462	(0,3)	0.106	0.23		1
F_fleet_3_YR_1987_s_1	0.842	(0,3)	0.153	0.182		1
F_fleet_3_YR_1988_s_1	0.548	(0,3)	0.138	0.252		1
F_fleet_3_YR_1989_s_1	0.665	(0,3)	0.142	0.214		1
F_fleet_3_YR_1990_s_1	0.202	(0,3)	0.042	0.207		1
F_fleet_3_YR_1991_s_1	0.495	(0,3)	0.096	0.194		1
F_fleet_3_YR_1992_s_1	0.683	(0,3)	0.121	0.177		1
F_fleet_3_YR_1993_s_1	0.734	(0,3)	0.134	0.183		1
F_fleet_3_YR_1994_s_1	0.526	(0,3)	0.094	0.179		1
F_fleet_3_YR_1995_s_1	0.276	(0,3)	0.061	0.221		1
F_fleet_3_YR_1996_s_1	0.351	(0,3)	0.059	0.168		1
F_fleet_3_YR_1997_s_1	0.373	(0,3)	0.078	0.209		1

Table 9 Continued. List of Stock Synthesis parameters for Gulf of Mexico Greater Amberjack.

Label	Value	Range	SD	CV	Prior	Phase
F_fleet_3_YR_1998_s_1	0.393	(0,3)	0.079	0.201		1
F_fleet_3_YR_1999_s_1	0.461	(0,3)	0.084	0.182		1
F_fleet_3_YR_2000_s_1	0.421	(0,3)	0.087	0.207		1
F_fleet_3_YR_2001_s_1	0.426	(0,3)	0.115	0.27		1
F_fleet_3_YR_2002_s_1	0.581	(0,3)	0.121	0.208		1
F_fleet_3_YR_2003_s_1	0.819	(0,3)	0.148	0.181		1
F_fleet_3_YR_2004_s_1	0.725	(0,3)	0.126	0.174		1
F_fleet_3_YR_2005_s_1	0.941	(0,3)	0.165	0.175		1
F_fleet_3_YR_2006_s_1	0.838	(0,3)	0.16	0.191		1
F_fleet_3_YR_2007_s_1	0.452	(0,3)	0.098	0.217		1
F_fleet_3_YR_2008_s_1	0.619	(0,3)	0.099	0.16		1
F_fleet_3_YR_2009_s_1	0.397	(0,3)	0.066	0.166		1
F_fleet_3_YR_2010_s_1	1.238	(0,3)	0.21	0.17		1
F_fleet_3_YR_2011_s_1	0.748	(0,3)	0.158	0.211		1
F_fleet_3_YR_2012_s_1	0.656	(0,3)	0.112	0.171		1
F_fleet_3_YR_2013_s_1	0.973	(0,3)	0.17	0.175		1
F_fleet_3_YR_2014_s_1	0.705	(0,3)	0.118	0.167		1
F_fleet_3_YR_2015_s_1	0.756	(0,3)	0.14	0.185		1
F_fleet_3_YR_2016_s_1	1.086	(0,3)	0.197	0.181		1
F_fleet_3_YR_2017_s_1	0.588	(0,3)	0.172	0.293		1
F_fleet_3_YR_2018_s_1	0.672	(0,3)	0.148	0.22		1
F_fleet_4_YR_1950_s_1	0.000	(0,3)	0	0		1
F_fleet_4_YR_1951_s_1	0.000	(0,3)	0	0		1
F_fleet_4_YR_1952_s_1	0.000	(0,3)	0	0		1
F_fleet_4_YR_1953_s_1	0.000	(0,3)	0	0		1
F_fleet_4_YR_1954_s_1	0.001	(0,3)	0	0		1
F_fleet_4_YR_1955_s_1	0.001	(0,3)	0	0		1
F_fleet_4_YR_1956_s_1	0.001	(0,3)	0	0		1
F_fleet_4_YR_1957_s_1	0.001	(0,3)	0	0		1
F_fleet_4_YR_1958_s_1	0.001	(0,3)	0	0		1
F_fleet_4_YR_1959_s_1	0.002	(0,3)	0	0		1
F_fleet_4_YR_1960_s_1	0.002	(0,3)	0	0		1
F_fleet_4_YR_1961_s_1	0.002	(0,3)	0.001	0.471		1

Table 9 Continued. List of Stock Synthesis parameters for Gulf of Mexico Greater Amberjack.

Label	Value	Range	SD	CV	Prior	Phase
F_fleet_4_YR_1962_s_1	0.002	(0,3)	0.001	0.416		1
F_fleet_4_YR_1963_s_1	0.003	(0,3)	0.001	0.372		1
F_fleet_4_YR_1964_s_1	0.003	(0,3)	0.001	0.336		1
F_fleet_4_YR_1965_s_1	0.003	(0,3)	0.001	0.307		1
F_fleet_4_YR_1966_s_1	0.004	(0,3)	0.001	0.277		1
F_fleet_4_YR_1967_s_1	0.004	(0,3)	0.001	0.253		1
F_fleet_4_YR_1968_s_1	0.004	(0,3)	0.001	0.231		1
F_fleet_4_YR_1969_s_1	0.005	(0,3)	0.001	0.212		1
F_fleet_4_YR_1970_s_1	0.005	(0,3)	0.001	0.196		1
F_fleet_4_YR_1971_s_1	0.005	(0,3)	0.001	0.193		1
F_fleet_4_YR_1972_s_1	0.006	(0,3)	0.002	0.36		1
F_fleet_4_YR_1973_s_1	0.006	(0,3)	0.002	0.337		1
F_fleet_4_YR_1974_s_1	0.006	(0,3)	0.002	0.331		1
F_fleet_4_YR_1975_s_1	0.009	(0,3)	0.003	0.352		1
F_fleet_4_YR_1976_s_1	0.009	(0,3)	0.003	0.353		1
F_fleet_4_YR_1977_s_1	0.008	(0,3)	0.003	0.362		1
F_fleet_4_YR_1978_s_1	0.009	(0,3)	0.003	0.352		1
F_fleet_4_YR_1979_s_1	0.010	(0,3)	0.004	0.382		1
F_fleet_4_YR_1980_s_1	0.012	(0,3)	0.004	0.347		1
F_fleet_4_YR_1981_s_1	0.011	(0,3)	0.004	0.357		1
F_fleet_4_YR_1982_s_1	0.012	(0,3)	0.004	0.33		1
F_fleet_4_YR_1983_s_1	0.014	(0,3)	0.004	0.282		1
F_fleet_4_YR_1984_s_1	0.012	(0,3)	0.003	0.258		1
F_fleet_4_YR_1985_s_1	0.010	(0,3)	0.003	0.315		1
F_fleet_4_YR_1986_s_1	0.110	(0,3)	0.029	0.264		1
F_fleet_4_YR_1987_s_1	0.079	(0,3)	0.021	0.266		1
F_fleet_4_YR_1988_s_1	0.058	(0,3)	0.015	0.26		1
F_fleet_4_YR_1989_s_1	0.108	(0,3)	0.028	0.259		1
F_fleet_4_YR_1990_s_1	0.079	(0,3)	0.02	0.255		1
F_fleet_4_YR_1991_s_1	0.023	(0,3)	0.006	0.257		1
F_fleet_4_YR_1992_s_1	0.054	(0,3)	0.012	0.223		1
F_fleet_4_YR_1993_s_1	0.063	(0,3)	0.015	0.239		1
F_fleet_4_YR_1994_s_1	0.070	(0,3)	0.016	0.228		1

Table 9 Continued. List of Stock Synthesis parameters for Gulf of Mexico Greater Amberjack.

Label	Value	Range	SD	CV	Prior	Phase
F_fleet_4_YR_1995_s_1	0.043	(0,3)	0.009	0.21		1
F_fleet_4_YR_1996_s_1	0.051	(0,3)	0.011	0.216		1
F_fleet_4_YR_1997_s_1	0.038	(0,3)	0.008	0.212		1
F_fleet_4_YR_1998_s_1	0.033	(0,3)	0.008	0.243		1
F_fleet_4_YR_1999_s_1	0.028	(0,3)	0.007	0.248		1
F_fleet_4_YR_2000_s_1	0.024	(0,3)	0.005	0.211		1
F_fleet_4_YR_2001_s_1	0.023	(0,3)	0.006	0.265		1
F_fleet_4_YR_2002_s_1	0.028	(0,3)	0.006	0.218		1
F_fleet_4_YR_2003_s_1	0.030	(0,3)	0.007	0.23		1
F_fleet_4_YR_2004_s_1	0.016	(0,3)	0.003	0.187		1
F_fleet_4_YR_2005_s_1	0.016	(0,3)	0.004	0.246		1
F_fleet_4_YR_2006_s_1	0.019	(0,3)	0.004	0.211		1
F_fleet_4_YR_2007_s_1	0.022	(0,3)	0.005	0.223		1
F_fleet_4_YR_2008_s_1	0.024	(0,3)	0.005	0.208		1
F_fleet_4_YR_2009_s_1	0.022	(0,3)	0.005	0.23		1
F_fleet_4_YR_2010_s_1	0.011	(0,3)	0.002	0.188		1
F_fleet_4_YR_2011_s_1	0.013	(0,3)	0.003	0.224		1
F_fleet_4_YR_2012_s_1	0.018	(0,3)	0.004	0.223		1
F_fleet_4_YR_2013_s_1	0.017	(0,3)	0.004	0.23		1
F_fleet_4_YR_2014_s_1	0.012	(0,3)	0.003	0.259		1
F_fleet_4_YR_2015_s_1	0.016	(0,3)	0.004	0.252		1
F_fleet_4_YR_2016_s_1	0.012	(0,3)	0.004	0.322		1
F_fleet_4_YR_2017_s_1	0.010	(0,3)	0.003	0.307		1
F_fleet_4_YR_2018_s_1	0.020	(0,3)	0.005	0.245		1
LnQ_base_Com_LL_2(2)	-6.526	(-20,0)				-1
LnQ_base_Headboat_4(4)	-5.694	(-25,25)				-1
LnQ_base_MRFSS_5(5)	-6.959	(-25,25)				-1
LnQ_base_JOINT_Video_Survey_6(6)	-7.050	(-25,25)				-1
SizeSpline_Code_Com_VL_1(1)	0.000	(0,2)				-99
SizeSpline_GradLo_Com_VL_1(1)	0.129	(-0.001,1)	0.031	0.241		3
SizeSpline_GradHi_Com_VL_1(1)	-0.047	(-1,0.001)	0.039	-0.832		3
SizeSpline_Knot_1_Com_VL_1(1)	31.064	(10,200)				-99
SizeSpline_Knot_2_Com_VL_1(1)	72.172	(10,200)				-99

Table 9 Continued. List of Stock Synthesis parameters for Gulf of Mexico Greater Amberjack.

Label	Value	Range	SD	CV	Prior	Phase
SizeSpline_Knot_3_Com_VL_1(1)	88.558	(10,200)				-99
SizeSpline_Knot_4_Com_VL_1(1)	98.014	(10,200)				-99
SizeSpline_Knot_5_Com_VL_1(1)	126.024	(10,200)				-99
SizeSpline_Val_1_Com_VL_1(1)	-4.238	(-9,7)	0.294	-0.069		2
SizeSpline_Val_2_Com_VL_1(1)	-2.546	(-9,7)	0.203	-0.08		2
SizeSpline_Val_3_Com_VL_1(1)	-1.000	(-9,7)				-99
SizeSpline_Val_4_Com_VL_1(1)	-0.267	(-9,7)	0.134	-0.501		2
SizeSpline_Val_5_Com_VL_1(1)	-1.051	(-9,7)	0.213	-0.203		2
Retain_L_infl_Com_VL_1(1)	40.212	(10,110)	7.186	0.179		3
Retain_L_width_Com_VL_1(1)	5.251	(1,25)	5.204	0.991		4
Retain_L_asymptote_logit_Com_VL_1(1)	10.000	(-10,10)				-7
Retain_L_maleoffset_Com_VL_1(1)	0.000	(-1,2)				-4
DiscMort_L_infl_Com_VL_1(1)	-10.000	(-10,10)				-3
DiscMort_L_width_Com_VL_1(1)	1.000	(-1,2)				-4
DiscMort_L_level_old_Com_VL_1(1)	0.100	(-1,2)				-2
DiscMort_L_male_offset_Com_VL_1(1)	0.000	(-1,2)				-4
Size_inflection_Com_LL_2(2)	105.291	(50,150)	2.626	0.025		2
Size_95%width_Com_LL_2(2)	26.475	(0.01,50)	1.911	0.072		2
Retain_L_infl_Com_LL_2(2)	11.928	(10,120)				-3
Retain_L_width_Com_LL_2(2)	1.301	(1,25)				-3
Retain_L_asymptote_logit_Com_LL_2(2)	10.000	(-10,10)				-4
Retain_L_maleoffset_Com_LL_2(2)	0.000	(-1,2)				-4
DiscMort_L_infl_Com_LL_2(2)	-10.000	(-10,10)				-2
DiscMort_L_width_Com_LL_2(2)	1.000	(-1,2)				-4
DiscMort_L_level_old_Com_LL_2(2)	0.100	(-1,2)				-2
DiscMort_L_male_offset_Com_LL_2(2)	0.000	(-1,2)				-4
Size_DblN_peak_Charter_Private_3(3)	71.000	(50,125)				-2
Size_DblN_top_logit_Charter_Private_3(3)	-5.000	(-5,15)				-3
Size_DblN_ascend_se_Charter_Private_3(3)	6.689	(-5,10)	0.095	0.014		2
Size_DblN_descend_se_Charter_Private_3(3)	8.000	(-5,10)				-3
Size_DblN_start_logit_Charter_Private_3(3)	-999.000	(-1500,15)				-2
Size_DblN_end_logit_Charter_Private_3(3)	-8.954	(-15,15)	80.674	-9.01		2
Retain_L_infl_Charter_Private_3(3)	37.202	(8,110)	1.242	0.033		3

Table 9 Continued. List of Stock Synthesis parameters for Gulf of Mexico Greater Amberjack.

Label	Value	Range	SD	CV	Prior	Phase
Retain_L_width_Charter_Private_3(3)	1.000	(1,25)				-3
Retain_L_asymptote_logit_Charter_Private_3(3)	10.000	(-10,10)				-7
Retain_L_maleoffset_Charter_Private_3(3)	0.000	(-1,2)				-4
DiscMort_L_infl_Charter_Private_3(3)	-10.000	(-10,10)				-2
DiscMort_L_width_Charter_Private_3(3)	1.000	(-1,2)				-4
DiscMort_L_level_old_Charter_Private_3(3)	0.200	(-1,2)				-2
DiscMort_L_male_offset_Charter_Private_3(3)	0.000	(-1,2)				-4
Size_DblN_peak_Headboat_4(4)	99.216	(50,125)	3.079	0.031		2
Size_DblN_top_logit_Headboat_4(4)	-5.000	(-5,15)				-3
Size_DblN_ascend_se_Headboat_4(4)	7.268	(-5,10)	0.106	0.015		3
Size_DblN_descend_se_Headboat_4(4)	5.000	(-5,10)				-3
Size_DblN_start_logit_Headboat_4(4)	-999.000	(-1500,15)				-2
Size_DblN_end_logit_Headboat_4(4)	-15.000	(-15,15)				-2
Retain_L_infl_Headboat_4(4)	7.290	(6,110)	1.348	0.185		3
Retain_L_width_Headboat_4(4)	1.000	(1,25)				-3
Retain_L_asymptote_logit_Headboat_4(4)	10.000	(-10,10)				-6
Retain_L_maleoffset_Headboat_4(4)	0.000	(-1,2)				-4
DiscMort_L_infl_Headboat_4(4)	-10.000	(-10,10)				-2
DiscMort_L_width_Headboat_4(4)	1.000	(-1,2)				-4
DiscMort_L_level_old_Headboat_4(4)	0.200	(-1,2)				-2
DiscMort_L_male_offset_Headboat_4(4)	0.000	(-1,2)				-4
Size_inflection_JOINT_Video_Survey_6(6)	35.517	(15,100)	2.164	0.061		2
Size_95%width_JOINT_Video_Survey_6(6)	13.523	(0.01,60)	2.121	0.157		2
minage@sel=1_Com_VL_1(1)	0.000	(0.1,10)				-3
maxage@sel=1_Com_VL_1(1)	10.000	(10,10)				-3
minage@sel=1_Com_LL_2(2)	0.000	(0.1,10)				-3
maxage@sel=1_Com_LL_2(2)	10.000	(10,10)				-3
minage@sel=1_Charter_Private_3(3)	0.000	(0.1,10)				-3
maxage@sel=1_Charter_Private_3(3)	10.000	(10,10)				-3
minage@sel=1_Headboat_4(4)	0.000	(0.1,10)				-3
maxage@sel=1_Headboat_4(4)	10.000	(10,10)				-3
minage@sel=1_JOINT_Video_Survey_6(6)	0.000	(0.1,10)				-3
maxage@sel=1_JOINT_Video_Survey_6(6)	10.000	(10,10)				-3

Table 9 Continued. List of Stock Synthesis parameters for Gulf of Mexico Greater Amberjack.

Label	Value	Range	SD	CV	Prior	Phase
ln(DM_theta)_1	0.095	(-5,5)	0.19	2.002		6
ln(DM_theta)_2	2.168	(-5,5)	0.684	0.316		6
ln(DM_theta)_3	-0.873	(-5,5)	0.143	-0.164		6
ln(DM_theta)_4	-0.690	(-5,5)	0.141	-0.204		6
ln(DM_theta)_5	-1.394	(-5,5)	0.183	-0.131		6
ln(DM_theta)_6	-0.086	(-5,5)	0.235	-2.722		6
ln(DM_theta)_7	1.609	(-5,5)	1.606	0.998		6
ln(DM_theta)_8	-1.379	(-5,5)	0.162	-0.117		6
ln(DM_theta)_9	-0.632	(-5,5)	0.251	-0.397		6
Retain_L_infl_Com_VL_1(1)_BLK1repl_1990	88.195	(40,120)	1.167	0.013		2
Retain_L_infl_Com_VL_1(1)_BLK1repl_2008	81.081	(40,120)	3.048	0.038		2
Retain_L_infl_Com_VL_1(1)_BLK1repl_2011	89.956	(40,120)	1.022	0.011		2
Retain_L_width_Com_VL_1(1)_BLK1repl_1990	4.772	(1,25)	1.937	0.406		4
Retain_L_width_Com_VL_1(1)_BLK1repl_2008	9.511	(1,25)	2.298	0.242		4
Retain_L_width_Com_VL_1(1)_BLK1repl_2011	4.457	(1,25)	0.934	0.21		4
Retain_L_infl_Com_LL_2(2)_BLK2repl_1990	92.243	(40,120)	2.88	0.031		2
Retain_L_width_Com_LL_2(2)_BLK2repl_1990	18.498	(1,25)	3.528	0.191		4
Retain_L_infl_Charter_Private_3(3)_BLK3repl_1990	65.816	(40,120)	1.648	0.025		2
Retain_L_infl_Charter_Private_3(3)_BLK3repl_1998	70.336	(40,120)	1.101	0.016		2
Retain_L_infl_Charter_Private_3(3)_BLK3repl_2008	83.211	(40,120)	1.668	0.02		2
Retain_L_infl_Charter_Private_3(3)_BLK3repl_2016	92.781	(40,120)	2.947	0.032		2
Retain_L_width_Charter_Private_3(3)_BLK3repl_1990	4.503	(1,25)	2.734	0.607		4
Retain_L_width_Charter_Private_3(3)_BLK3repl_1998	2.968	(1,25)	1.391	0.469		4
Retain_L_width_Charter_Private_3(3)_BLK3repl_2008	6.567	(1,25)	0.685	0.104		4
Retain_L_width_Charter_Private_3(3)_BLK3repl_2016	4.743	(1,25)	1.482	0.312		4
Retain_L_infl_Headboat_4(4)_BLK3repl_1990	63.153	(40,120)	2.507	0.04		2
Retain_L_infl_Headboat_4(4)_BLK3repl_1998	67.980	(40,120)	1.767	0.026		2
Retain_L_infl_Headboat_4(4)_BLK3repl_2008	77.150	(40,120)	1.881	0.024		2
Retain_L_infl_Headboat_4(4)_BLK3repl_2016	93.938	(40,120)	4.966	0.053		2
Retain_L_width_Headboat_4(4)_BLK3repl_1990	8.549	(1,40)	4.527	0.53		4
Retain_L_width_Headboat_4(4)_BLK3repl_1998	8.861	(1,25)	2.193	0.247		4
Retain_L_width_Headboat_4(4)_BLK3repl_2008	9.056	(1,25)	1.535	0.17		4
Retain_L_width_Headboat_4(4)_BLK3repl_2016	9.961	(1,25)	2.844	0.286		4

Table 10. Estimates of annual exploitation rate (total biomass killed age 1+ / total biomass age 1+) combined across all fleets for Gulf of Mexico Greater Amberjack, which was used as the proxy for annual fishing mortality rate. Estimates are provided for the SEDAR70 Operational Assessment and the SEDAR33 Update. Values are not directly comparable between SEDAR 70 and SEDAR 33 Update due to multiple factors including data updates, new data, and differences in SS model configurations.

Year	SEDAR70	SEDAR33 Update
1950	0.027	0.016
1951	0.032	0.019
1952	0.038	0.022
1953	0.044	0.025
1954	0.051	0.028
1955	0.057	0.031
1956	0.062	0.034
1957	0.068	0.036
1958	0.074	0.039
1959	0.079	0.041
1960	0.086	0.044
1961	0.088	0.045
1962	0.091	0.045
1963	0.093	0.046
1964	0.095	0.047
1965	0.097	0.048
1966	0.101	0.049
1967	0.105	0.051
1968	0.109	0.053
1969	0.115	0.056
1970	0.118	0.056
1971	0.124	0.060
1972	0.130	0.065
1973	0.136	0.070
1974	0.143	0.076
1975	0.153	0.085
1976	0.166	0.095
1977	0.183	0.108
1978	0.205	0.125
1979	0.233	0.144
1980	0.267	0.163
1981	0.201	0.105
1982	0.466	0.253
1983	0.432	0.166
1984	0.154	0.150
1985	0.298	0.229

Table 10 Continued. Estimates of annual exploitation rate (total biomass killed age 1+ / total biomass age 1+) combined across all fleets for Gulf of Mexico Greater Amberjack, which was used as the proxy for annual fishing mortality rate. Estimates are provided for SEDAR70 Operational Assessment and SEDAR33 Update.

Year	SEDAR70	SEDAR33 Update
1986	0.423	0.383
1987	0.639	0.537
1988	0.550	0.480
1989	0.611	0.669
1990	0.248	0.322
1991	0.438	0.737
1992	0.507	0.598
1993	0.558	0.710
1994	0.467	0.674
1995	0.349	0.508
1996	0.402	0.624
1997	0.384	0.518
1998	0.305	0.421
1999	0.343	0.407
2000	0.316	0.418
2001	0.274	0.373
2002	0.367	0.419
2003	0.512	0.534
2004	0.460	0.544
2005	0.526	0.521
2006	0.493	0.428
2007	0.310	0.339
2008	0.291	0.390
2009	0.223	0.463
2010	0.507	0.417
2011	0.363	0.307
2012	0.317	0.287
2013	0.419	0.330
2014	0.335	0.313
2015	0.354	0.345
2016	0.384	
2017	0.256	
2018	0.279	

Table 11. Annual apical estimates of fishing mortality by fleet for Gulf of Mexico Greater Amberjack.

Year	Commercial Vertical Line	Commercial Longline	Charter Private	Headboat
1950	0.000	0.000	0.042	0.000
1951	0.000	0.000	0.051	0.000
1952	0.000	0.000	0.061	0.000
1953	0.000	0.000	0.070	0.000
1954	0.000	0.000	0.081	0.001
1955	0.000	0.000	0.092	0.001
1956	0.000	0.000	0.100	0.001
1957	0.000	0.000	0.108	0.001
1958	0.000	0.000	0.116	0.001
1959	0.000	0.000	0.125	0.002
1960	0.000	0.000	0.134	0.002
1961	0.000	0.000	0.137	0.002
1962	0.000	0.000	0.139	0.002
1963	0.000	0.000	0.142	0.003
1964	0.000	0.000	0.144	0.003
1965	0.000	0.000	0.146	0.003
1966	0.000	0.000	0.151	0.004
1967	0.002	0.000	0.156	0.004
1968	0.001	0.000	0.162	0.004
1969	0.004	0.000	0.168	0.005
1970	0.001	0.000	0.174	0.005
1971	0.002	0.000	0.182	0.005
1972	0.003	0.000	0.191	0.006
1973	0.002	0.000	0.200	0.006
1974	0.003	0.000	0.209	0.006
1975	0.006	0.000	0.220	0.009
1976	0.007	0.000	0.240	0.009
1977	0.010	0.000	0.265	0.008
1978	0.013	0.000	0.299	0.009
1979	0.014	0.000	0.344	0.010
1980	0.019	0.001	0.398	0.012
1981	0.026	0.003	0.276	0.011
1982	0.027	0.007	0.757	0.012
1983	0.047	0.011	0.660	0.014
1984	0.100	0.017	0.152	0.012
1985	0.115	0.029	0.331	0.010
1986	0.150	0.052	0.462	0.110

Table 11 Continued. Annual apical estimates of fishing mortality by fleet for Gulf of Mexico Greater Amberjack.

Year	Commercial Vertical Line	Commercial Longline	Charter Private	Headboat
1987	0.268	0.083	0.842	0.079
1988	0.482	0.155	0.548	0.058
1989	0.563	0.186	0.665	0.108
1990	0.639	0.151	0.202	0.079
1991	0.675	0.029	0.495	0.023
1992	0.298	0.035	0.683	0.054
1993	0.569	0.058	0.734	0.063
1994	0.673	0.071	0.526	0.070
1995	0.744	0.088	0.276	0.043
1996	0.720	0.066	0.351	0.051
1997	0.589	0.059	0.373	0.038
1998	0.358	0.052	0.393	0.033
1999	0.385	0.063	0.461	0.028
2000	0.382	0.064	0.421	0.024
2001	0.284	0.037	0.426	0.023
2002	0.245	0.052	0.581	0.028
2003	0.249	0.068	0.819	0.030
2004	0.266	0.047	0.725	0.016
2005	0.252	0.048	0.941	0.016
2006	0.260	0.065	0.838	0.019
2007	0.282	0.054	0.452	0.022
2008	0.176	0.076	0.619	0.024
2009	0.194	0.034	0.397	0.022
2010	0.162	0.015	1.238	0.011
2011	0.180	0.007	0.748	0.013
2012	0.102	0.006	0.656	0.018
2013	0.166	0.010	0.973	0.017
2014	0.210	0.016	0.705	0.012
2015	0.183	0.020	0.756	0.016
2016	0.180	0.015	1.086	0.012
2017	0.167	0.016	0.588	0.010
2018	0.098	0.014	0.672	0.020

Table 12. Predicted biomass (metric tons), spawning stock biomass (SSB, metric tons), abundance (1000s of fish), age-0 recruits (1000s of fish), and SSB ratio (SSB/SSB₀) where SSB₀ = 23,733 metric tons for Gulf of Mexico Greater Amberjack.

Year	Biomass	SSB	Abundance	Recruits	SSB/SSB ₀
1950	29,642	20,718	5,203	3,659	0.873
1951	29,336	20,504	5,152	3,656	0.864
1952	28,869	20,160	5,098	3,651	0.849
1953	28,266	19,694	5,041	3,644	0.830
1954	27,555	19,123	4,978	3,635	0.806
1955	26,762	18,471	4,911	3,623	0.778
1956	25,906	17,760	4,839	3,610	0.748
1957	25,058	17,047	4,770	3,596	0.718
1958	24,226	16,345	4,702	3,581	0.689
1959	23,412	15,659	4,635	3,566	0.660
1960	22,615	14,990	4,567	3,549	0.632
1961	21,836	14,340	4,500	3,532	0.604
1962	21,162	13,770	4,442	3,515	0.580
1963	20,582	13,277	4,392	3,500	0.559
1964	20,080	12,851	4,348	3,486	0.542
1965	19,648	12,486	4,309	3,473	0.526
1966	19,274	12,172	4,275	3,462	0.513
1967	18,906	11,871	4,239	3,450	0.500
1968	18,531	11,568	4,202	3,438	0.487
1969	18,163	11,274	4,165	3,426	0.475
1970	17,773	10,960	4,125	3,444	0.462
1971	17,412	10,667	4,102	3,440	0.449
1972	17,028	10,352	4,072	3,431	0.436
1973	16,632	10,027	4,036	3,413	0.423
1974	16,224	9,701	3,994	3,358	0.409
1975	15,783	9,365	3,928	3,254	0.395
1976	15,256	8,991	3,823	3,123	0.379
1977	14,575	8,545	3,674	2,927	0.360
1978	13,699	7,993	3,466	2,770	0.337
1979	12,619	7,306	3,236	2,900	0.308
1980	11,416	6,470	3,124	3,560	0.273
1981	10,256	5,535	3,332	2,641	0.233
1982	10,365	5,297	3,116	3,750	0.223
1983	7,938	3,687	3,126	5,044	0.155
1984	7,274	2,844	3,864	2,111	0.120
1985	9,424	3,490	3,256	6,107	0.147
1986	9,982	3,996	4,623	3,236	0.168

Table 12 Continued. Predicted biomass (metric tons), spawning stock biomass (SSB, metric tons), abundance (1000s of fish), age-0 recruits (1000s of fish), and SSB ratio (SSB/SSB₀) for Gulf of Mexico Greater Amberjack.

Year	Biomass	SSB	Abundance	Recruits	SSB/SSB ₀
1987	9,503	3,639	3,832	1,565	0.153
1988	6,851	2,495	2,259	5,912	0.105
1989	6,019	2,086	3,800	2,944	0.088
1990	5,827	1,513	3,157	962	0.064
1991	7,314	2,298	2,307	1,610	0.097
1992	6,624	2,826	1,951	1,240	0.119
1993	5,088	2,408	1,530	1,579	0.101
1994	3,807	1,621	1,481	1,190	0.068
1995	3,464	1,327	1,341	870	0.056
1996	3,591	1,413	1,168	1,533	0.060
1997	3,501	1,433	1,360	1,992	0.060
1998	3,626	1,391	1,694	1,243	0.059
1999	4,223	1,495	1,554	3,675	0.063
2000	4,883	1,662	2,612	4,267	0.070
2001	6,194	1,896	3,509	2,294	0.080
2002	7,753	2,440	3,102	1,727	0.103
2003	7,974	3,032	2,506	2,289	0.128
2004	6,537	2,801	2,308	1,284	0.118
2005	5,628	2,413	1,797	1,628	0.102
2006	4,556	1,841	1,643	2,683	0.078
2007	4,217	1,538	2,103	2,357	0.065
2008	5,049	1,685	2,310	2,643	0.071
2009	5,942	2,060	2,565	1,878	0.087
2010	6,951	2,757	2,395	1,323	0.116
2011	5,803	2,394	1,809	2,099	0.101
2012	5,560	2,463	1,975	2,135	0.104
2013	5,633	2,475	2,113	1,665	0.104
2014	5,267	2,113	1,904	2,272	0.089
2015	5,386	2,197	2,132	1,053	0.093
2016	5,330	2,238	1,667	1,020	0.094
2017	4,847	2,199	1,372	1,244	0.093
2018	4,850	2,432	1,385	1,813	0.103

Table 13. Observed (Obs) and predicted (Exp) landings by fleet for the commercial fisheries in weight (ww, metric tons) and number (1000s of fish) for Gulf of Mexico Greater Amberjack. Note that the standard errors were as follows: Commercial Vertical Line (0.05) and Commercial Longline (0.05).

Year	Vertical Line (Obs, ww)	Vertical Line (Exp, ww)	Vertical Line (Exp, Number)	Longline (Obs, ww)	Longline (Exp, ww)	Longline (Exp, Number)
1963	3.824	3.824	0.281	0.000	0.000	0.000
1964	2.855	2.855	0.211	0.002	0.002	0.000
1965	2.353	2.353	0.175	0.000	0.000	0.000
1966	3.319	3.319	0.248	0.000	0.000	0.000
1967	13.110	13.110	0.983	0.000	0.000	0.000
1968	5.168	5.168	0.389	0.000	0.000	0.000
1969	32.732	32.732	2.476	0.000	0.000	0.000
1970	6.127	6.127	0.465	0.007	0.007	0.000
1971	17.269	17.269	1.318	0.000	0.000	0.000
1972	17.846	17.846	1.369	0.852	0.852	0.042
1973	12.689	12.689	0.979	0.001	0.001	0.000
1974	18.739	18.739	1.453	0.000	0.000	0.000
1975	35.084	35.084	2.736	0.000	0.000	0.000
1976	38.813	38.812	3.040	0.012	0.012	0.001
1977	53.556	53.555	4.211	0.267	0.267	0.013
1978	67.646	67.646	5.336	0.006	0.006	0.000
1979	66.752	66.752	5.288	1.256	1.256	0.064
1980	77.869	77.869	6.251	2.227	2.227	0.113
1981	95.452	95.451	7.956	10.116	10.116	0.519
1982	82.889	82.889	7.080	17.665	17.665	0.921
1983	104.757	104.764	9.593	20.469	20.469	1.094
1984	209.821	209.828	21.701	27.700	27.701	1.568
1985	293.565	293.555	29.767	51.912	51.912	3.170
1986	417.237	417.398	42.410	95.086	95.089	5.995
1987	588.697	589.108	61.183	119.534	119.540	7.570
1988	784.983	785.096	81.019	157.290	157.274	10.394
1989	747.917	746.455	86.948	145.094	145.020	9.851
1990	504.128	501.164	44.316	69.514	69.456	4.494
1991	792.307	786.401	68.940	16.419	16.415	1.169
1992	455.903	453.926	36.641	26.161	26.152	1.766
1993	692.362	679.631	51.641	44.246	39.313	2.405
1994	547.380	535.223	41.383	36.575	35.394	2.095
1995	525.356	519.772	41.419	38.573	37.009	2.248
1996	536.999	537.597	43.042	28.377	27.945	1.752

Table 13 Continued. Observed (Obs) and predicted (Exp) landings by fleet for the commercial fisheries in weight (ww, metric tons) and number (1000s of fish) for Gulf of Mexico Greater Amberjack.

Year	Vertical Line (Obs, ww)	Vertical Line (Exp, ww)	Vertical Line (Exp, Number)	Longline (Obs, ww)	Longline (Exp, ww)	Longline (Exp, Number)
1997	459.038	463.202	36.721	26.061	26.059	1.622
1998	273.915	276.642	21.900	23.553	23.836	1.442
1999	300.773	303.504	24.390	29.642	29.995	1.836
2000	353.250	349.779	29.179	32.547	32.926	2.075
2001	298.448	297.270	25.134	21.972	22.201	1.406
2002	312.389	310.187	26.394	36.397	36.479	2.402
2003	382.091	383.646	31.550	53.607	53.769	3.570
2004	394.041	397.227	31.351	37.347	37.783	2.390
2005	292.232	294.746	22.747	33.071	33.448	2.022
2006	233.624	234.982	18.532	34.879	35.263	2.132
2007	239.629	239.027	19.265	27.023	27.231	1.654
2008	171.235	173.028	15.140	41.436	41.430	2.562
2009	247.262	249.794	21.910	22.550	22.740	1.449
2010	240.516	236.823	20.099	11.006	11.115	0.703
2011	230.326	229.650	17.958	5.344	5.395	0.337
2012	138.017	139.187	10.636	4.939	5.000	0.302
2013	206.083	205.054	15.479	7.695	7.784	0.454
2014	229.996	228.074	17.577	11.329	11.463	0.674
2015	213.099	208.316	16.281	13.975	14.142	0.849
2016	206.166	207.122	15.952	10.898	11.018	0.665
2017	207.342	208.459	15.843	12.208	12.352	0.743
2018	135.503	136.449	10.015	12.161	12.303	0.712

Table 14. Observed (Obs) and predicted (Exp) landings by fleet for the recreational fisheries in weight (ww, metric tons) and number (1000s of fish) for Gulf of Mexico Greater Amberjack. Note that the standard errors were as follows: Recreational Charter Private (0.25) and Recreational Headboat (0.21).

Year	Charter Private (Obs, Number)	Charter Private (Exp, Number)	Charter Private (Exp, ww)	Headboat (Obs, Number)	Headboat (Exp, Number)	Headboat (Exp, ww)
1950	102.889	102.888	776.432	0.450	0.450	3.825
1951	123.467	123.465	930.930	0.540	0.540	4.586
1952	144.044	144.042	1083.310	0.630	0.630	5.338
1953	164.622	164.618	1231.680	0.720	0.720	6.077
1954	185.200	185.194	1375.780	0.810	0.810	6.799
1955	205.778	205.768	1515.740	0.900	0.900	7.507
1956	218.831	218.818	1596.810	1.200	1.200	9.941
1957	231.884	231.866	1675.660	1.490	1.490	12.259
1958	244.937	244.914	1752.740	1.790	1.790	14.627
1959	257.990	257.959	1828.180	2.090	2.090	16.963
1960	271.043	271.003	1901.950	2.390	2.390	19.267
1961	271.749	271.702	1888.410	2.690	2.690	21.539
1962	272.455	272.400	1876.490	2.990	2.990	23.795
1963	273.161	273.097	1866.730	3.290	3.290	26.046
1964	273.867	273.792	1858.980	3.590	3.590	28.294
1965	274.573	274.486	1852.970	3.890	3.890	30.543
1966	281.185	281.078	1887.820	4.250	4.250	33.257
1967	287.796	287.668	1922.270	4.600	4.600	35.871
1968	294.407	294.255	1955.910	4.960	4.960	38.533
1969	301.019	300.836	1988.420	5.320	5.320	41.160
1970	307.630	307.410	2020.020	5.680	5.680	43.749
1971	318.449	318.172	2076.400	5.680	5.680	43.525
1972	329.269	328.907	2129.480	5.980	5.980	45.549
1973	340.088	339.610	2182.080	6.280	6.280	47.554
1974	350.907	350.275	2234.300	6.280	6.280	47.299
1975	361.727	360.942	2287.670	8.670	8.670	65.005
1976	382.304	381.451	2406.770	8.370	8.370	62.559
1977	402.881	402.263	2528.460	7.770	7.770	57.935
1978	423.457	423.825	2653.690	7.470	7.470	55.531
1979	444.034	447.230	2778.450	8.370	8.370	61.712
1980	464.611	472.948	2852.500	8.370	8.372	59.941
1981	327.881	333.911	1876.220	7.770	7.975	54.224
1982	896.104	829.923	4582.030	7.770	7.781	51.378
1983	482.745	626.561	3136.110	7.770	7.778	46.450

Table 14 Continued. Observed (Obs) and predicted (Exp) landings by fleet for the recreational fisheries in weight (ww, metric tons) and number (1000s of fish) for Gulf of Mexico Greater Amberjack.

Year	Charter Private (Obs, Number)	Charter Private (Exp, Number)	Charter Private (Exp, ww)	Headboat (Obs, Number)	Headboat (Exp, Number)	Headboat (Exp, ww)
1984	155.049	187.578	824.642	7.770	7.581	41.219
1985	570.517	467.026	2315.130	7.770	7.577	44.733
1986	489.706	638.349	3110.860	86.020	87.277	527.615
1987	1306.600	1068.700	4992.940	52.890	53.594	313.138
1988	329.389	485.852	2466.160	29.660	30.245	179.721
1989	473.968	596.005	2422.030	52.520	52.282	266.545
1990	89.132	86.328	650.472	24.260	24.562	179.088
1991	333.375	291.632	2235.090	9.850	10.177	80.418
1992	379.227	309.321	2654.440	19.750	19.330	173.728
1993	196.448	214.973	1917.230	14.050	14.709	134.760
1994	134.192	121.939	1047.620	13.120	12.642	109.417
1995	55.301	66.634	547.904	8.670	7.915	65.762
1996	137.635	89.399	737.962	10.510	9.955	84.447
1997	70.126	85.305	736.871	7.540	6.827	60.137
1998	68.110	72.431	724.137	5.110	5.340	48.725
1999	123.246	103.017	983.915	5.290	5.417	47.532
2000	99.061	105.308	1025.450	6.000	5.119	46.025
2001	113.744	129.998	1276.920	6.010	6.177	53.007
2002	234.766	255.525	2359.450	10.690	10.335	87.197
2003	315.708	371.951	3455.570	11.980	11.613	104.297
2004	246.435	253.604	2481.680	6.240	4.831	45.540
2005	217.248	257.845	2538.810	3.990	3.859	35.637
2006	134.064	192.354	1860.970	4.730	3.693	33.766
2007	68.677	95.772	950.878	4.460	4.159	37.666
2008	142.140	85.977	1164.400	4.820	4.016	41.224
2009	112.171	74.227	970.396	5.240	4.845	49.757
2010	149.766	245.864	3206.990	2.570	2.507	26.234
2011	112.563	138.489	1790.670	2.990	2.904	30.682
2012	149.101	116.860	1536.470	3.840	3.701	40.193
2013	131.738	152.342	2069.090	3.130	3.166	34.316
2014	138.357	108.573	1448.810	1.990	2.098	22.052
2015	121.194	123.089	1622.810	2.870	3.030	32.032
2016	109.607	86.489	1782.500	1.100	1.159	17.315
2017	39.830	50.774	981.684	0.920	0.965	14.246
2018	86.479	61.077	1143.770	2.460	2.008	29.927

Table 15. Observed (Obs) and predicted (Exp) discards by fleet for the commercial fisheries in weight (ww, metric tons) and number (1000s of fish) for Gulf of Mexico Greater Amberjack. The standard errors were as follows: Commercial Vertical Line (0.25) and Commercial Longline (0.25).

Year	Vertical Line (Obs, Number)	Vertical Line (Exp, Number)	Vertical Line (Exp, ww)	Longline (Obs, Number)	Longline (Exp, Number)	Longline (Exp, ww)
1993	30.180	37.209	19.619	0.620	1.318	1.592
1994	30.630	39.859	18.461	0.800	1.167	1.360
1995	37.450	43.881	20.813	0.880	1.362	1.509
1996	38.850	40.301	21.163	0.870	1.091	1.209
1997	38.210	33.767	16.362	0.960	0.966	1.104
1998	32.710	23.823	10.222	1.940	0.843	0.956
1999	42.350	27.151	12.781	2.250	1.142	1.242
2000	33.290	37.267	15.146	2.880	1.334	1.436
2001	36.400	37.392	14.346	1.400	0.938	0.974
2002	31.650	34.265	16.201	1.820	1.707	1.734
2003	35.690	29.625	16.180	2.620	2.391	2.581
2004	36.320	26.352	13.564	2.750	1.428	1.644
2005	27.020	19.710	10.002	2.780	1.152	1.337
2006	22.090	17.909	8.719	2.070	1.254	1.422
2007	21.740	22.617	9.391	1.260	0.995	1.107
2008	19.548	14.743	6.113	1.630	1.639	1.748
2009	23.100	18.847	8.542	1.210	0.950	1.016
2010	11.230	14.539	7.262	0.610	0.440	0.488
2011	15.290	16.912	9.590	0.780	0.203	0.231
2012	11.350	9.415	5.080	0.350	0.169	0.200
2013	13.320	15.047	7.462	0.650	0.244	0.291
2014	16.360	18.802	9.592	0.940	0.385	0.440
2015	12.920	17.345	8.811	1.070	0.496	0.565
2016	17.090	15.217	8.420	1.100	0.386	0.443
2017	14.800	12.865	7.780	0.990	0.417	0.493
2018	8.560	7.020	4.163	0.600	0.362	0.453

Table 16. Observed (Obs) and predicted (Exp) discards by fleet for the recreational fisheries in weight (ww, metric tons) and number (1000s of fish) for Gulf of Mexico Greater Amberjack. The standard errors were as follows: Recreational Charter Private (0.25) and Recreational Headboat (0.5).

Year	Charter Private (Obs, Number)	Charter Private (Exp, Number)	Charter Private (Exp, ww)	Headboat (Obs, Number)	Headboat (Exp, Number)	Headboat (Exp, ww)
1981	38.130	37.659	4.360	0.005	0.001	0.001
1982	87.957	94.271	9.130	0.154	0.001	0.001
1983	162.086	111.801	10.850	0.421	0.001	0.000
1984	33.864	25.992	3.331	0.000	0.001	0.000
1985	43.587	49.387	3.860	0.001	0.001	0.001
1986	110.919	95.956	11.710	14.212	0.009	0.005
1987	72.778	93.856	11.820	0.301	0.004	0.002
1988	119.888	69.272	4.670	0.074	0.006	0.002
1989	172.696	128.518	15.740	1.850	0.007	0.002
1990	185.604	181.393	87.822	26.612	22.358	12.703
1991	348.563	297.446	167.640	6.839	5.095	3.616
1992	322.310	270.526	133.120	7.638	7.737	5.249
1993	321.673	255.245	119.560	13.173	7.412	4.491
1994	182.616	183.030	81.396	7.137	8.024	4.527
1995	119.484	95.050	45.986	3.744	4.937	2.981
1996	79.563	104.139	51.169	4.279	5.274	3.327
1997	130.064	121.351	51.115	3.006	4.098	2.248
1998	196.222	184.992	87.688	7.296	5.155	3.104
1999	223.080	235.654	119.137	5.904	5.000	3.175
2000	340.347	294.331	121.975	3.720	5.511	2.978
2001	1492.920	431.300	203.230	8.991	7.424	4.269
2002	748.640	562.095	312.420	8.224	9.244	6.396
2003	664.760	565.064	315.710	6.910	7.791	5.778
2004	386.374	424.110	215.340	1.980	3.344	2.298
2005	543.235	478.222	258.050	2.552	2.909	2.016
2006	507.998	377.028	182.630	1.790	2.994	1.917
2007	328.476	260.827	116.941	3.369	4.282	2.451
2008	369.371	512.787	319.999	4.637	7.206	5.236
2009	267.774	363.301	242.011	5.619	7.351	5.757
2010	1063.260	1024.830	728.030	2.981	3.336	2.775
2011	690.032	505.669	370.430	3.107	3.486	3.000
2012	370.876	428.347	287.810	3.834	4.399	3.573
2013	703.340	673.826	435.650	4.665	4.416	3.397
2014	422.740	491.141	331.600	5.750	3.014	2.385

Table 16 Continued. Observed (Obs) and predicted (Exp) discards by fleet for the recreational fisheries in weight (ww, metric tons) and number (1000s of fish) for Gulf of Mexico Greater Amberjack. The standard errors were as follows: Recreational Charter Private (0.25) and Recreational Headboat (0.5).

Year	Charter Private (Obs, Number)	Charter Private (Exp, Number)	Charter Private (Exp, ww)	Headboat (Obs, Number)	Headboat (Exp, Number)	Headboat (Exp, ww)
2015	515.972	529.273	354.170	8.235	4.121	3.285
2016	673.160	772.986	637.120	7.500	4.204	4.497
2017	542.797	349.806	308.598	4.484	2.932	3.397
2018	305.405	367.947	305.958	3.499	5.533	6.350

Table 17. Observed (Obs) versus predicted (Exp) standardized fishery-dependent catch-per-unit-effort (CPUE) indices and associated lognormal standard error (as estimated by the GLM standardization model) for Gulf of Mexico Greater Amberjack. Values are normalized to the mean.

Year	LL (Obs)	LL (Exp)	LL (SE)	HBT (Obs)	HBT (Exp)	HBT (SE)	CH-PR (Obs)	CH-PR (Exp)	CH-PR (SE)
1986				3.768	2.678	0.147	3.297	1.475	0.752
1987				1.899	2.285	0.177	2.393	1.255	0.775
1988				2.019	1.763	0.167	0.773	0.932	0.829
1989				1.528	1.627	0.179	1.815	1.002	0.815
1990	0.531	0.674	0.525	0.631	1.053	0.240	0.197	1.241	0.952
1991	0.791	0.840	0.430	0.742	1.464	0.221	1.952	1.108	0.800
1992	1.438	1.080	0.446	1.265	1.210	0.181	1.834	0.784	0.752
1993	0.564	0.992	0.402	0.762	0.790	0.194	0.656	0.591	0.821
1994	0.373	0.726	0.397	0.605	0.607	0.211	0.564	0.539	0.833
1995	0.582	0.616	0.400	0.713	0.620	0.206	0.498	0.548	0.876
1996	0.524	0.619	0.423	0.819	0.657	0.198	0.355	0.514	0.864
1997	0.587	0.645	0.392	0.630	0.608	0.231	0.390	0.517	0.848
1998	0.586	0.675	0.399	0.431	0.547	0.251	0.237	0.614	0.824
1999	0.574	0.695	0.394	0.566	0.647	0.273	0.237	0.687	0.804
2000	0.601	0.755	0.400	0.564	0.726	0.264	0.541	0.888	0.799
2001	0.731	0.876	0.388	0.952	0.919	0.216	1.244	1.235	0.763
2002	1.003	1.022	0.386	1.091	1.264	0.229	1.291	1.315	0.745
2003	1.060	1.165	0.373	1.476	1.283	0.207	1.216	1.059	0.746
2004	1.342	1.182	0.385	1.134	1.013	0.204	0.787	0.868	0.757
2005	1.817	1.019	0.380	0.521	0.799	0.254	0.798	0.723	0.776
2006	1.319	0.794	0.381	0.716	0.656	0.259	0.631	0.629	0.798
2007	0.974	0.737	0.396	0.430	0.625	0.267	0.812	0.738	0.787
2008	1.470	0.796	0.384	1.464	0.563	0.276	0.688	0.906	0.782
2009	2.044	0.982	0.396	0.770	0.750	0.227	0.918	1.034	0.780
2010	1.825	1.116	0.479						
2011	0.830	1.091	0.494	0.896	0.731	0.310	1.315	0.804	0.785
2012	1.426	1.211	0.663	0.788	0.694	0.309	0.916	0.777	0.790
2013	1.912	1.174	0.602	0.716	0.614	0.305	0.926	0.791	0.790
2014	0.455	1.042	0.478	0.491	0.609	0.375	0.555	0.795	0.825
2015	1.192	1.045	0.462	0.611	0.642	0.266	1.163	0.805	0.767
2016	1.100	1.043	0.442						
2017	0.750	1.124	0.490						
2018	0.603	1.302	0.579						

Table 18. Observed (Obs) versus predicted (Exp) standardized fishery-independent indices and associated lognormal standard error (as estimated by the GLM standardization model) for Gulf of Mexico Greater Amberjack. Values are normalized to the mean.

Year	VIDEO (Obs)	VIDEO (Exp)	VIDEO (SE)
1993	0.621	0.737	0.245
1994	1.200	0.707	0.517
1995	0.738	0.695	0.254
1996	0.642	0.619	0.205
1997	1.011	0.667	0.622
2002	2.295	1.626	0.186
2004	0.788	1.111	0.208
2005	1.097	0.891	0.193
2006	0.744	0.792	0.159
2007	0.972	1.004	0.186
2008	0.922	1.173	0.216
2009	1.336	1.324	0.135
2010	0.756	1.180	0.181
2011	0.919	0.964	0.157
2012	1.150	0.991	0.123
2013	1.103	1.029	0.168
2014	1.183	0.991	0.194
2015	0.974	1.047	0.120
2016	1.037	0.892	0.337
2017	0.765	0.760	0.127
2018	0.745	0.736	0.284

Table 19. Summary of correlated parameters with correlation coefficients > 0.7 parameters for Gulf of Mexico Greater Amberjack from the SEDAR70 SS base model.

Parameter 1	Parameter 2	Correlation
Retain_L_infl_Charter_Private_3(3)	Size_DblN_ascend_se_Charter_Private_3(3)	-0.737
Retain_L_width_Charter_Private_3(3) _BLK3repl_1998	Retain_L_infl_Charter_Private_3(3) _BLK3repl_1998	0.751
Retain_L_width_Charter_Private_3(3) _BLK3repl_2008	Retain_L_infl_Charter_Private_3(3) _BLK3repl_2008	0.762
Retain_L_width_Charter_Private_3(3) _BLK3repl_2016	Retain_L_infl_Charter_Private_3(3) _BLK3repl_2016	0.777
Retain_L_width_Com_LL_2(2)_BLK 2repl_1990	Retain_L_infl_Com_LL_2(2)_BLK 2repl_1990	-0.708
Size_95%width_Com_LL_2(2)	Size_inflection_Com_LL_2(2)	0.738
Size_DblN_ascend_se_Headboat_4(4)	Size_DblN_peak_Headboat_4(4)	0.851

Table 20. Summary of key model building runs towards the SEDAR70 SS Base Model for Gulf of Mexico Greater Amberjack. Note that steps within each model progression are not shown due to the large number of intermediate runs conducted. Values are not directly comparable between SEDAR 70 and SEDAR 33 Update due to multiple factors including data updates, new data, and differences in SS model configurations.

Model Name	Description	SS Version	NLL	Gradient	ln(R0)	R1 offset (SS3.24), Regime (SS3.3)
S33 2016 Update	S33 2016 Update	3.24s	1,191.02	0.003	7.930	-0.002
Step 1	SS3.30 converted model of the S33 Update model	3.30_15	1,164.04	0.000	7.940	-0.001
Step 2	Step 1 + FES catches for Charter/Private	3.30_15	1,192.82	0.005	8.380	0.000
Step 3	Step 2 + all new revised data	3.30_15	2,479.67	0.007	8.260	0.001
Step 4	Step 3 + updated growth, maturation parameters, added extra time block for Charter/Private and Headboat	3.30_15	2,411.43	0.024	8.090	0.000
Step 5	Step 4 + final length and age compositions (weighted), Dirichlet multinomial likelihoods, index reweightings, steepness prior, removal of Commercial Vertical Line index, estimating all three S/R parameters	3.30_15	1,652.89	0.010	8.550	-0.003
Step 6	Final Base Model SEDAR 70, no steepness prior, fixed sigmaR, fixed steepness, spline selex on Commercial Vertical Line	3.30_15	1,656.56	0.013	8.220	0.000

Model Name	Steepness	Sigma R	K	Virgin SSB (mt)	Virgin Recr (1000s)	SPRratio 1950	F 1950
S33 2016 Update	0.850	0.600	0.210	18,836	2,773	0.130	0.020
Step 1	0.850	0.600	0.210	18,817	2,821	0.130	0.020
Step 2	0.850	0.600	0.210	28,944	4,340	0.220	0.030
Step 3	0.850	0.600	0.200	24,151	3,881	0.250	0.030
Step 4	0.850	0.600	0.170	17,218	3,274	0.260	0.040
Step 5	0.680	0.450	0.230	33,381	5,141	0.140	0.020
Step 6	0.780	0.520	0.230	23,733	3,698	0.190	0.030

Table 21. Estimated parameters from the ASPIC model. The q parameter corresponds to estimated selectivity for each fleet. The B1/K value is fixed for the start year (1986) of the model.

Label	Value
B1/K	0.5
MSY	14,812,909 lb
K	80,754,321 lb
q_Longline	5.59e-08
q_Headboat	5.09e-08
q_Charter_Private	4.71e-08
B _{MSY}	40,377,161 lb
F _{MSY}	0.367
B/B _{MSY}	0.469
F/F _{MSY}	0.642
Contrast	0.404
Nearness	1
Objective function	24.953
Model performance	Normal convergence

Table 22. Settings used for Gulf of Mexico Greater Amberjack projections.

Parameter	Value	Comment
Relative F	Average from 2016 – 2018	Average relative fishing mortality over terminal three years (2016-2018) of model
Selectivity	Average from 2016 – 2018	Average fleet specific selectivity estimated over terminal three years (2016-2018) of model
Retention	Average from 2016 – 2018	Average fleet specific retention estimated over terminal three years (2016-2018) of model
Recruitment	Average from 2009 – 2018	Average recruitment over last 10 years
2019 and 2020 Landings	284.01 mt (Commercial Vertical Line), 11.90 mt (Commercial Longline), 65.43 thousands of fish (Charter/Private), 1.38 thousands of fish (Headboat)	Average of 2016-2018 landings
Allocation Ratio	27:73	commercial:recreational

Table 23. Summary of Magnuson-Stevens Reauthorization Act benchmarks and reference points for the SEDAR 70 Gulf of Mexico Greater Amberjack assessment. Spawning Stock Biomass (SSB) is in metric tons, whereas F is a harvest rate (total biomass killed age 1+ / total biomass age 1+).

Variable	Definition	Value
Base M	Fully selected ages of Lorenzen Natural Mortality (M)	0.28
Steepness	Fixed Stock-Recruit (SR) parameter (not used in projections)	0.777
Virgin Recruitment	Estimated SR parameter (not used in projections)	3,698
Generation Time	Fecundity-weighted mean age	7.59
SSB Unfished	Estimated virgin spawning stock biomass	23,733
Mortality Rate Criteria		
$F_{MSYproxy}$	Equilibrium F that achieves SPR30%	0.175
MFMT	Equilibrium F that achieves SPR30%	0.175
$F_{Rebuild}$	F that rebuilds the stock to $SSB_{SPR30\%}$ by 2027	0.039
F_{OY}	0.75 * Directed F at $F_{SPR30\%}$	0.131
$F_{current}$	Geometric mean (F2016-2018)= $F_{Current}$	0.302
$F_{Current}/F_{MSYproxy}$	Current stock status based on $F_{MSYproxy}$	1.729
$F_{Current}/MFMT$	Current stock status based on MFMT	1.729
Biomass Criteria		
$SSB_{MSYproxy}$	Equilibrium SSB at $F_{SPR30\%}$	7,119
MSST	$0.5 * SSB_{SPR30\%}$	3,559
SSB at Optimum Yield	Equilibrium SSB when Directed F = 0.75 * Directed F at $F_{SPR30\%}$	8,530
SSB_{2018}	SSB_{2018}	2,433
$SSB_{2018}/SSB_{FMSYproxy}$	Current stock status based on $SSB_{SPR30\%}$ (Equilibrium)	0.34
$SSB_{2018}/MSST$	Current stock status based on $MSST_{SPR30\%}$	0.68
$SSB_{2018}/SSB_{unfished}$	2018 SPR	0.10

Table 24. Time series of fishing mortality and SSB relative to associated SPR based biological reference points. SSB is in metric tons, whereas F is a harvest rate (total biomass killed age 1+ / total biomass age 1+). Reference points include $F_{SPR30\%} = 0.175$, $SSB_{FSPR30\%} = 7,119$ metric tons, and $MSST_{FSPR30\%} = 3,559$ metric tons which was calculated as $(0.5) * SSB_{FSPR30\%}$. SSB_{ratio} was calculated as annual SSB divided by SSB_0 where $SSB_0 = 23,733$ metric tons.

Year	F	F/ F_{SPR30}	SSB	SSB/ SSB_{SPR30}	SSB/MSST	SSB/ SSB_0
1950	0.027	0.152	20,719	2.911	5.821	0.873
1951	0.032	0.181	20,504	2.880	5.761	0.864
1952	0.038	0.215	20,160	2.832	5.664	0.849
1953	0.044	0.248	19,694	2.767	5.533	0.830
1954	0.051	0.288	19,123	2.686	5.373	0.806
1955	0.057	0.322	18,471	2.595	5.190	0.778
1956	0.062	0.350	17,761	2.495	4.990	0.748
1957	0.068	0.384	17,048	2.395	4.790	0.718
1958	0.074	0.418	16,345	2.296	4.592	0.689
1959	0.079	0.446	15,659	2.200	4.400	0.660
1960	0.086	0.486	14,991	2.106	4.212	0.632
1961	0.088	0.497	14,341	2.015	4.029	0.604
1962	0.091	0.514	13,771	1.935	3.869	0.580
1963	0.093	0.525	13,278	1.865	3.731	0.559
1964	0.095	0.536	12,852	1.805	3.611	0.542
1965	0.097	0.548	12,487	1.754	3.508	0.526
1966	0.101	0.570	12,173	1.710	3.420	0.513
1967	0.105	0.593	11,871	1.668	3.335	0.500
1968	0.109	0.616	11,568	1.625	3.250	0.487
1969	0.115	0.649	11,274	1.584	3.168	0.475
1970	0.118	0.666	10,961	1.540	3.080	0.462
1971	0.124	0.700	10,668	1.499	2.997	0.449
1972	0.130	0.734	10,353	1.454	2.909	0.436
1973	0.136	0.768	10,028	1.409	2.818	0.423
1974	0.143	0.808	9,702	1.363	2.726	0.409
1975	0.153	0.864	9,365	1.316	2.631	0.395
1976	0.166	0.937	8,992	1.263	2.526	0.379
1977	0.183	1.033	8,546	1.201	2.401	0.360
1978	0.205	1.158	7,993	1.123	2.246	0.337
1979	0.233	1.316	7,307	1.027	2.053	0.308
1980	0.267	1.508	6,471	0.909	1.818	0.273
1981	0.201	1.135	5,536	0.778	1.555	0.233

Table 24 Continued. Time series of fishing mortality and SSB relative to associated SPR based biological reference points. SSB is in metric tons, whereas F is a harvest rate (total biomass killed age 1+ / total biomass age 1+). Reference points include $F_{SPR30\%} = 0.175$, $SSB_{FSPR30\%} = 7,119$ metric tons, and $MSST_{FSPR30\%} = 3,559$ metric tons which was calculated as $(0.5) * SSB_{FSPR30\%}$. SSBratio was calculated as annual SSB divided by SSB_0 where $SSB_0 = 23,733$ metric tons.

Year	F	F/ F_{SPR30}	SSB	SSB/ SSB_{SPR30}	SSB/MSST	SSB/ SSB_0
1982	0.466	2.631	5,297	0.744	1.488	0.223
1983	0.432	2.439	3,687	0.518	1.036	0.155
1984	0.154	0.870	2,844	0.400	0.799	0.120
1985	0.298	1.683	3,490	0.490	0.981	0.147
1986	0.423	2.389	3,996	0.561	1.123	0.168
1987	0.639	3.608	3,640	0.511	1.023	0.153
1988	0.550	3.106	2,496	0.351	0.701	0.105
1989	0.611	3.450	2,087	0.293	0.586	0.088
1990	0.248	1.400	1,514	0.213	0.425	0.064
1991	0.438	2.473	2,298	0.323	0.646	0.097
1992	0.507	2.863	2,827	0.397	0.794	0.119
1993	0.558	3.151	2,408	0.338	0.677	0.101
1994	0.467	2.637	1,621	0.228	0.455	0.068
1995	0.349	1.971	1,328	0.187	0.373	0.056
1996	0.402	2.270	1,414	0.199	0.397	0.060
1997	0.384	2.168	1,433	0.201	0.403	0.060
1998	0.305	1.722	1,391	0.195	0.391	0.059
1999	0.343	1.937	1,496	0.210	0.420	0.063
2000	0.316	1.784	1,663	0.234	0.467	0.070
2001	0.274	1.547	1,896	0.266	0.533	0.080
2002	0.367	2.072	2,441	0.343	0.686	0.103
2003	0.512	2.891	3,032	0.426	0.852	0.128
2004	0.460	2.598	2,802	0.394	0.787	0.118
2005	0.526	2.970	2,414	0.339	0.678	0.102
2006	0.493	2.784	1,841	0.259	0.517	0.078
2007	0.310	1.751	1,539	0.216	0.432	0.065
2008	0.291	1.643	1,685	0.237	0.473	0.071
2009	0.223	1.259	2,060	0.289	0.579	0.087
2010	0.507	2.863	2,758	0.387	0.775	0.116
2011	0.363	2.050	2,394	0.336	0.673	0.101
2012	0.317	1.790	2,463	0.346	0.692	0.104
2013	0.419	2.366	2,476	0.348	0.696	0.104

Table 24 Continued. Time series of fishing mortality and SSB relative to associated SPR based biological reference points. SSB is in metric tons, whereas F is a harvest rate (total biomass killed age 1+ / total biomass age 1+). Reference points include $F_{SPR30\%} = 0.175$, $SSB_{FSPR30\%} = 7,119$ metric tons, and $MSST_{FSPR30\%} = 3,559$ metric tons which was calculated as $(0.5) * SSB_{FSPR30\%}$. SSBratio was calculated as annual SSB divided by SSB_0 where $SSB_0 = 23,733$ metric tons.

Year	F	F/ F_{SPR30}	SSB	SSB/ SSB_{SPR30}	SSB/MSST	SSB/ SSB_0
2014	0.335	1.892	2,114	0.297	0.594	0.089
2015	0.354	1.999	2,197	0.309	0.617	0.093
2016	0.384	2.168	2,239	0.315	0.629	0.094
2017	0.256	1.446	2,199	0.309	0.618	0.093
2018	0.279	1.575	2,433	0.342	0.684	0.103

Table 25. Results of the OFL projections (fishing set at $F_{SPR30\%}$) for Gulf of Mexico Greater Amberjack. Recruitment is in 1000s of age-0 fish, SSB is in metric tons, F is a harvest rate (total biomass killed age 1+ / total biomass age 1+), and OFL is the overfishing limit in millions of pounds whole weight. Reference points include $F_{SPR30\%} = 0.175$, $SSB_{FSPR30\%} = 7,119$ metric tons, and $MSST_{FSPR30\%} = 3,559$ metric tons which was calculated as $(0.5) * SSB_{FSPR30\%}$. SSB_{ratio} was calculated as annual SSB divided by SSB_0 where $SSB_0 = 23,733$ metric tons.

Year	R	F	F/ F_{SPR30}	SSB	SSB/ SSB_{SPR30}	SSB/MSST	SSB/ SSB_0	OFL
2021	2,805	0.147	0.842	1,999	0.281	0.562	0.084	1.160
2022	2,805	0.154	0.882	2,706	0.380	0.760	0.114	1.623
2023	2,805	0.165	0.945	3,662	0.514	1.029	0.154	2.250
2024	2,805	0.172	0.985	4,612	0.648	1.296	0.194	2.820
2025	2,805	0.176	1.008	5,381	0.756	1.512	0.227	3.236
2026	2,805	0.178	1.019	5,948	0.836	1.671	0.251	3.510
2027	2,805	0.178	1.019	6,345	0.891	1.783	0.267	3.683
2028	2,805	0.178	1.019	6,617	0.930	1.859	0.279	3.791
2029	2,805	0.178	1.019	6,807	0.956	1.912	0.287	3.859
2030	2,805	0.177	1.014	6,926	0.973	1.946	0.292	3.901

Table 26. Results of projections at F_{Rebuild} for Gulf of Mexico Greater Amberjack, which will rebuild the stock to SSB_{SPR30} (7,119 metric tons) by 2027. Recruitment is in 1000s of age-0 fish, SSB is in metric tons, F is a harvest rate (total biomass killed age 1+ / total biomass age 1+), and retained yield (Yield) in millions of pounds whole weight. Reference points include $SSB_{\text{FSPR30\%}} = 7,119$ metric tons and $MSST_{\text{FSPR30\%}} = 3,559$ metric tons ($0.5 * SSB_{\text{FSPR30\%}}$). SSB_{ratio} was calculated as annual SSB divided by SSB_0 where $SSB_0 = 23,733$ metric tons.

Year	R	F	SSB	SSB/SSB_{SPR30}	$SSB/MSST$	SSB/SSB_0	Yield
2021	2,805	0.039	1,999	0.281	0.562	0.084	0.315
2022	2,805	0.065	3,023	0.425	0.849	0.127	0.763
2023	2,805	0.102	4,337	0.609	1.219	0.183	1.614
2024	2,805	0.138	5,579	0.784	1.568	0.235	2.636
2025	2,805	0.161	6,443	0.905	1.810	0.271	3.425
2026	2,805	0.173	6,918	0.972	1.944	0.291	3.850
2027	2,805	0.177	7,127	1.001	2.002	0.300	4.010
2028	2,805	0.178	7,200	1.011	2.023	0.303	4.041
2029	2,805	0.178	7,219	1.014	2.028	0.304	4.029
2030	2,805	0.177	7,205	1.012	2.024	0.304	4.001

Table 27. Summary of projected retained yields in millions of pounds whole weight (mp ww) over the short-term for each projection scenario along with rebuilding time for Gulf of Mexico Greater Amberjack. Reference points include $F_{SPR30\%} = 0.175$, $SSB_{FSPR30\%} = 7,119$ metric tons, and $MSST_{FSPR30\%} = 3,559$ metric tons which was calculated as $(0.5) * SSB_{FSPR30\%}$.

Criteria	Definitions	Yield	Year SSB>MSST	Year SSB>SSB _{SPR30}
OFL	Annual yield (mp ww) at MFMT= $F_{SPR30\%}$		2023	2034
	2021	1.160		
	2022	1.623		
	2023	2.250		
	2024	2.820		
	2025	3.236		
	2026	3.510		
ABC	Annual yield (mp, ww) at $F_{Rebuild}$		2023	2027
	2021	0.315		
	2022	0.763		
	2023	1.614		
	2024	2.636		
	2025	3.425		
	2026	3.850		

Table 28. Summary of projections that achieve an SPR of 30% in equilibrium completed for Gulf of Mexico Greater Amberjack using the original SEDAR33 Update Base Model, the SEDAR33 Update Base Model with the recreational data updated to the FES values, and the SEDAR70 Base Model. Shown are the terminal data year of each assessment, terminal year spawning stock biomass (SSB in metric tons), terminal year recruitment (R in 1000s of fish), $F_{SPR30\%}$, virgin spawning biomass (SSB_0 in metric tons), $SSB_{FSPR30\%}$, and equilibrium yield (retained yield in millions of pounds whole weight). Values are not directly comparable between SEDAR 70 and SEDAR 33 Update due to multiple factors including data updates, new data, and differences in SS model configurations.

Model	Terminal year (TY)	SSB (TY)	Recruits (TY)	F_{SPR30}	SSB_0	SSB_{SPR30}	Equilibrium Yield (mp ww)
S33 Update	2015	1,640.28	1,341	0.198	18,779	5,685	3.706
S33 Update with FES	2015	2,169.95	2,507	0.199	28,986	8,798	5.968
S70 Operational	2018	2,432.83	1,813	0.175	23,733	7,119	3.969

9. Figures

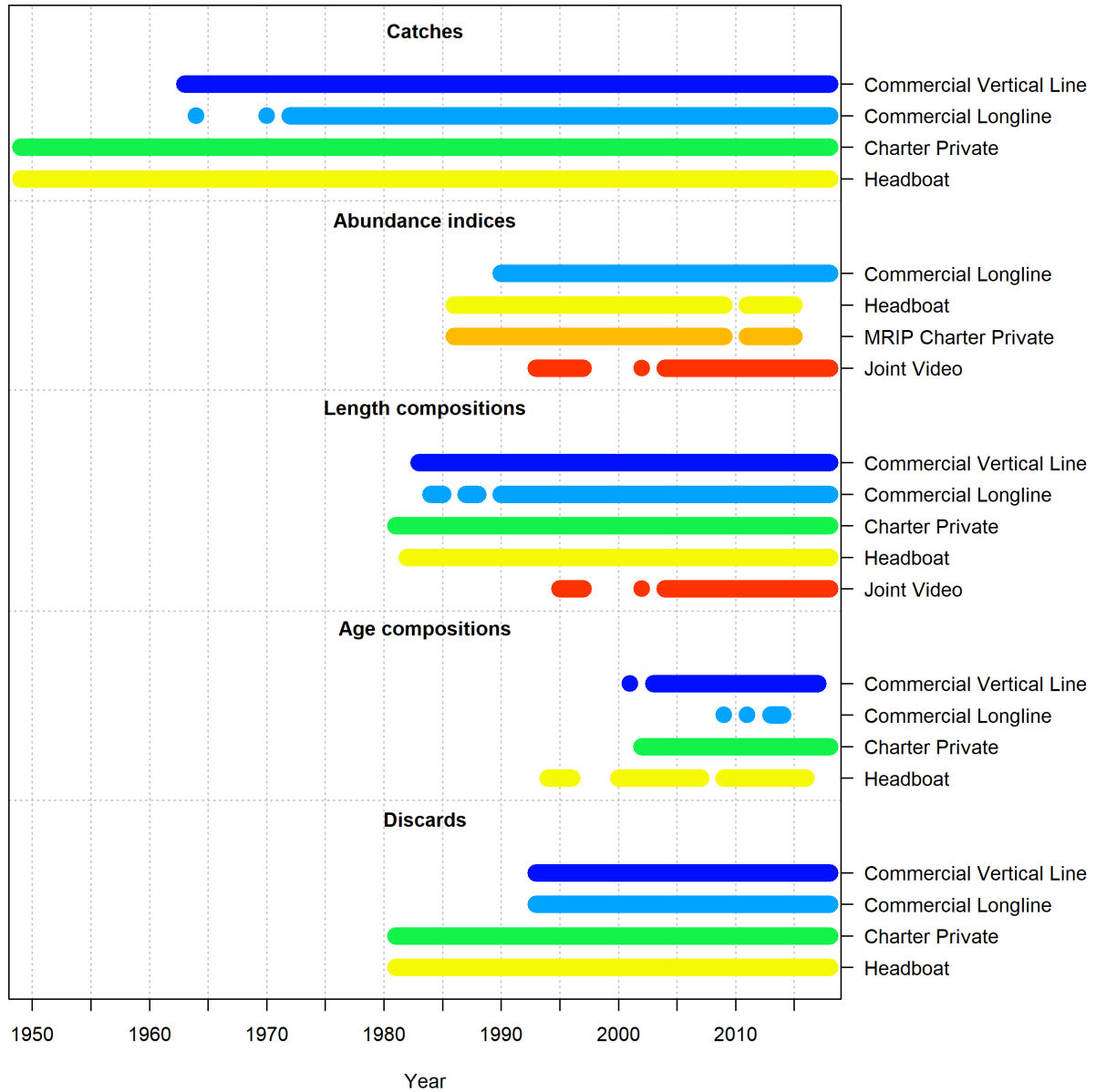

Figure 1. Data sources used in the assessment model for Gulf of Mexico Greater Amberjack.

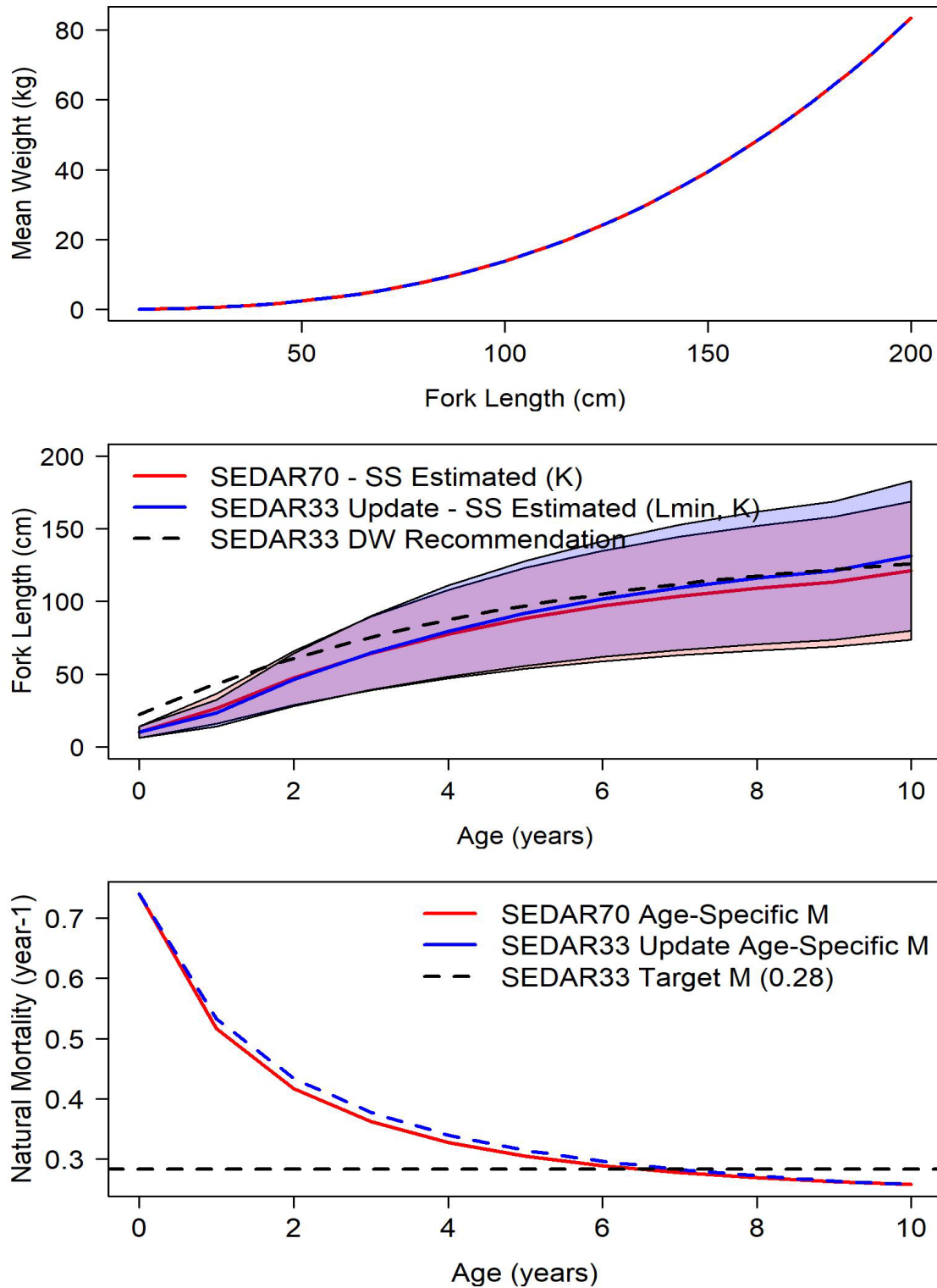

Figure 2. Mean weight-at-length (top panel), recommended and estimated growth curves (with 95% confidence intervals) (middle panel), and natural mortality (bottom panel) used in the assessment model for Gulf of Mexico Greater Amberjack.

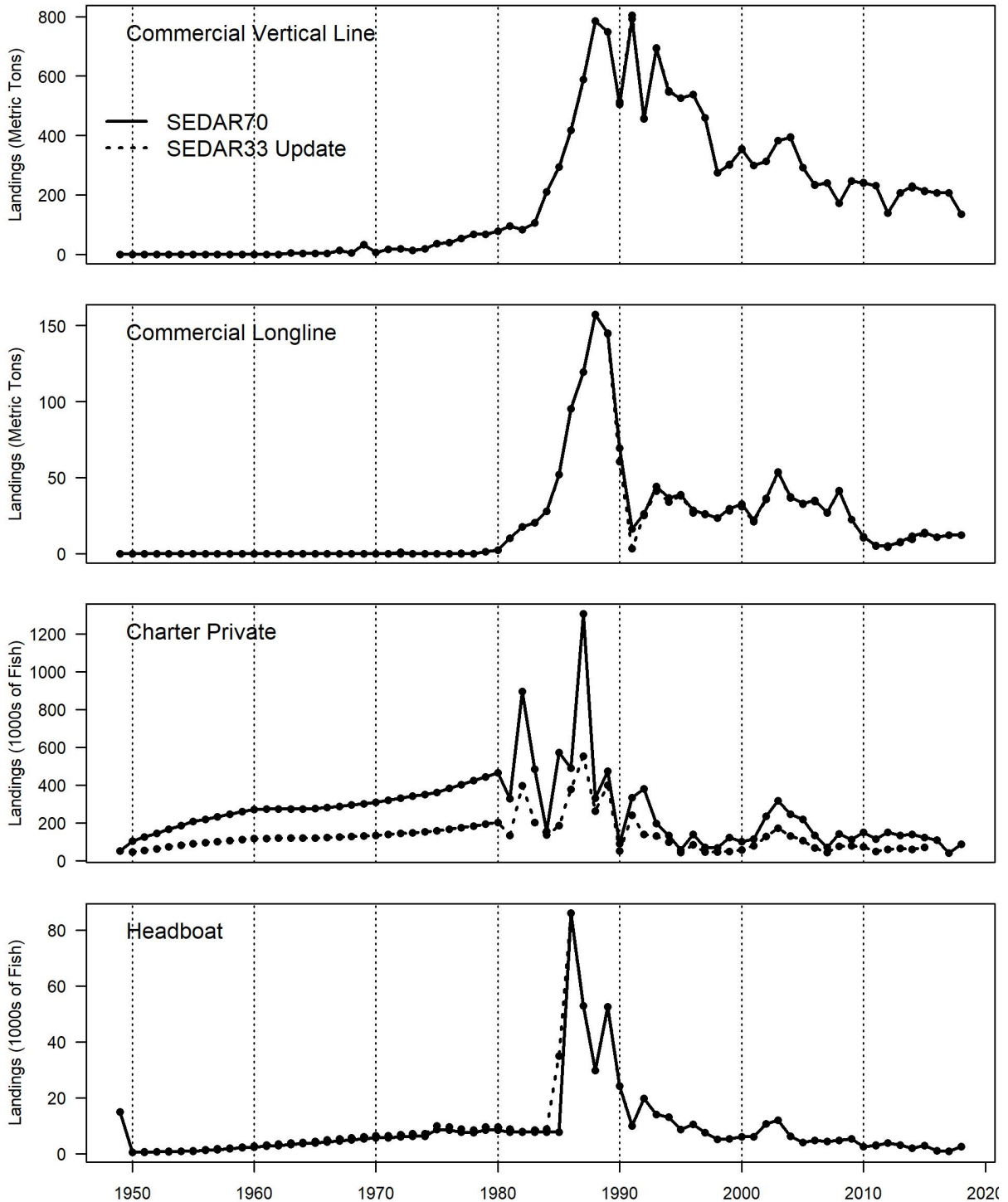

Figure 3. Gulf of Mexico Greater Amberjack observed landings by fishery for SEDAR70 and SEDAR33 Update. Commercial and recreational landings are in metric tons and numbers of fish, respectively. Dashed vertical lines identify ten-year intervals.

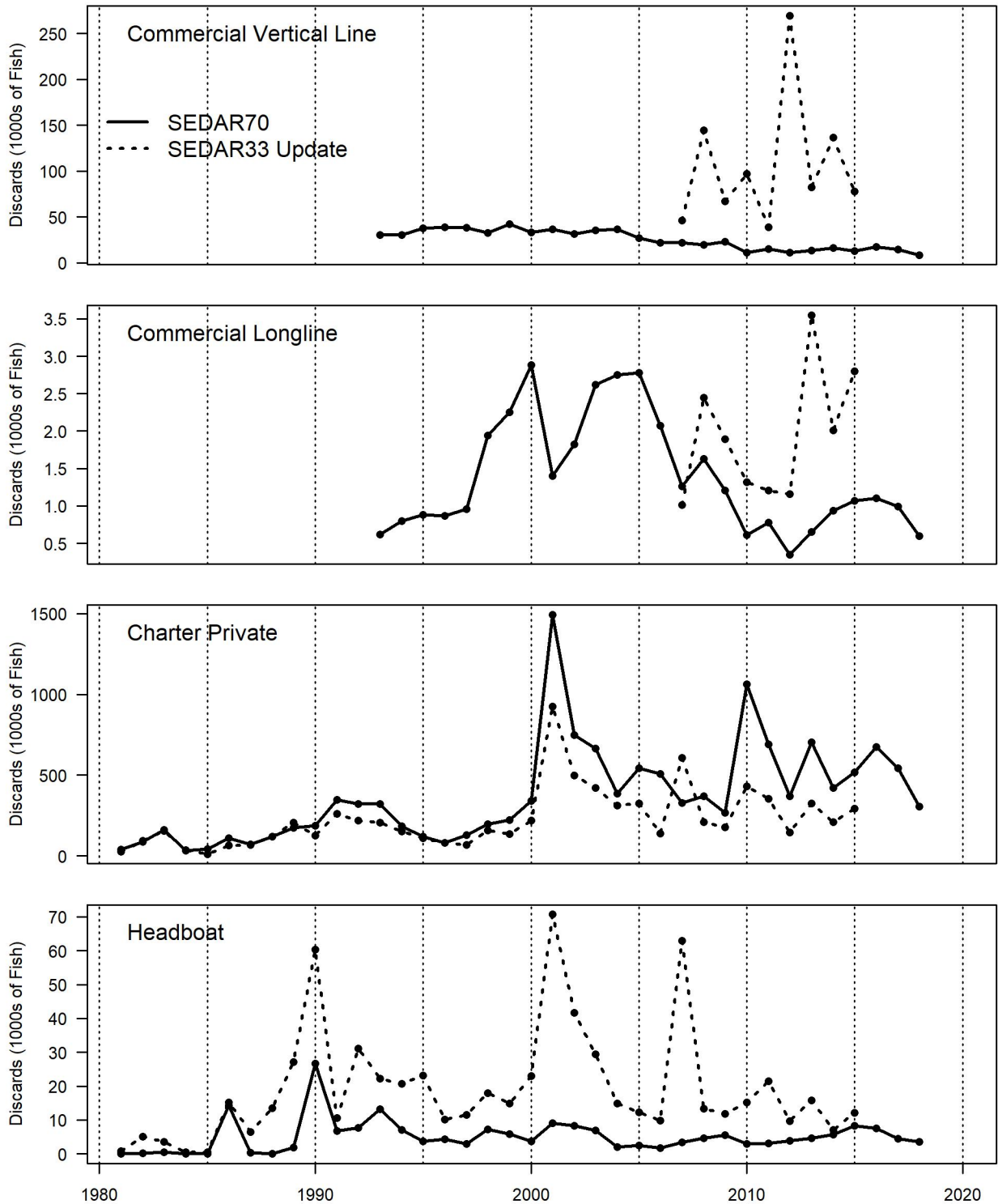

Figure 4. Gulf of Mexico Greater Amberjack observed discards by fishery for SEDAR70 and SEDAR33 Update. Commercial and recreational discards are both in numbers of fish. Dashed vertical lines identify five-year intervals.

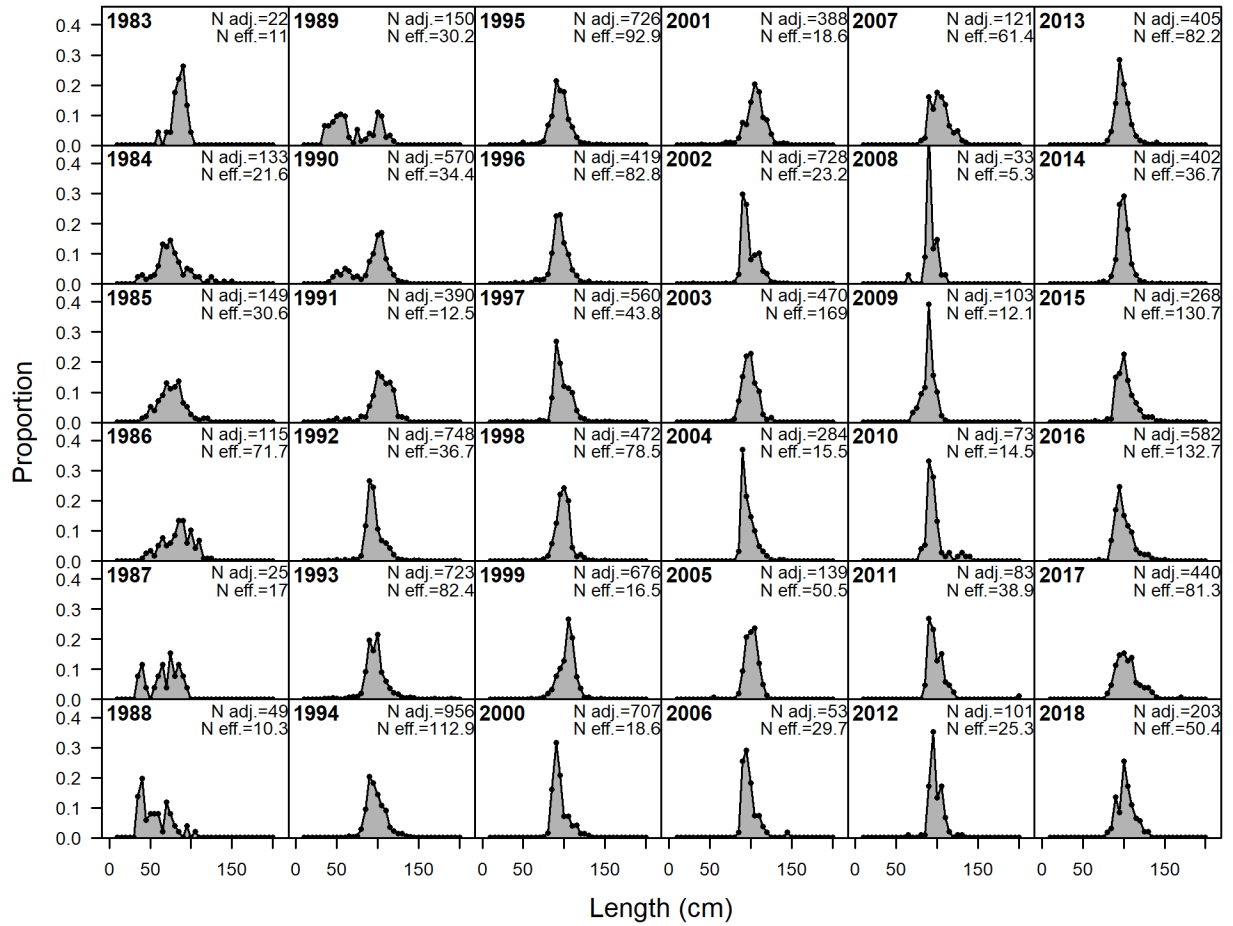

Figure 5. Observed length composition data (retained) of Gulf of Mexico Greater Amberjack in the Commercial Vertical Line fishery.

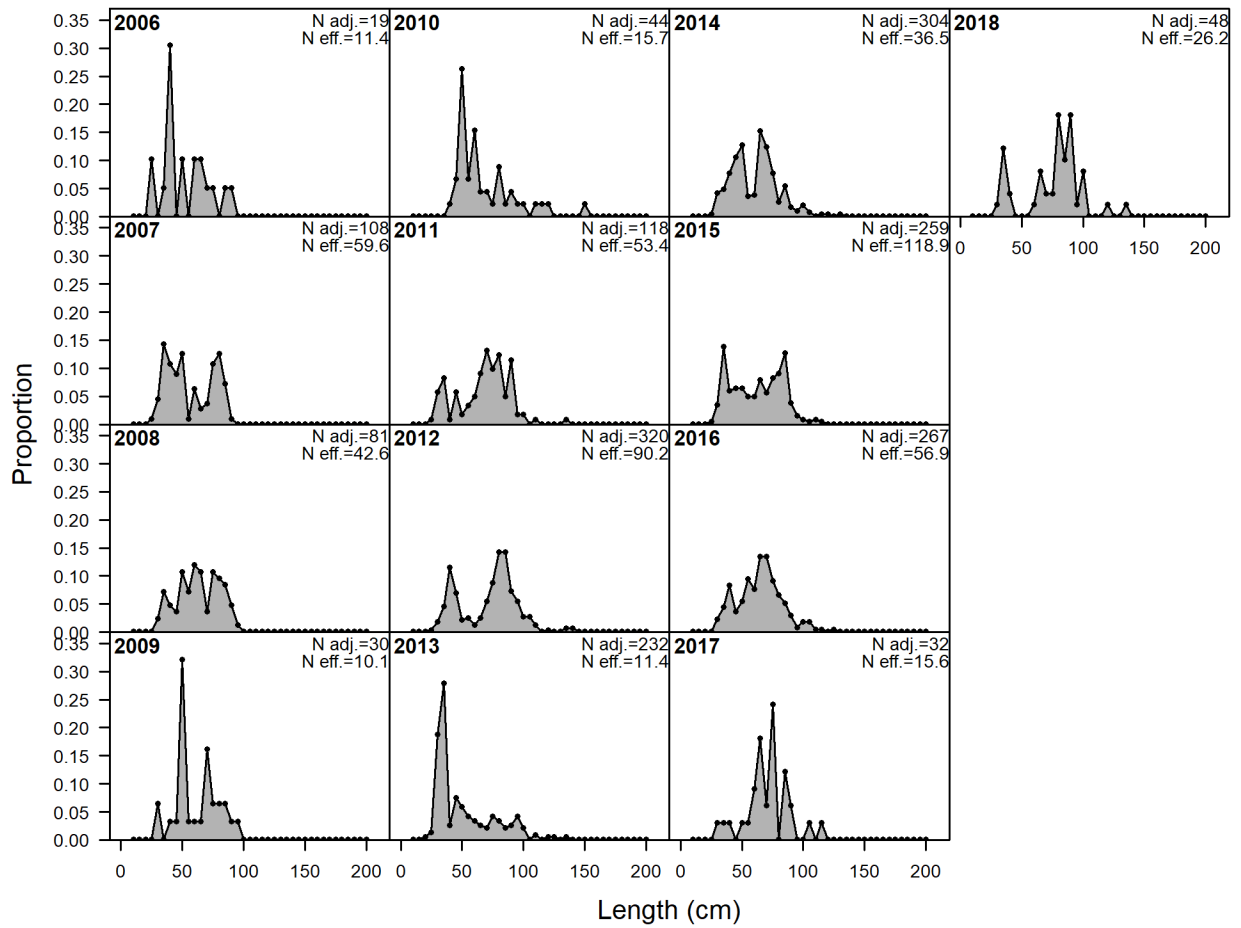

Figure 6. Observed length composition data (discarded) for Gulf of Mexico Greater Amberjack from the Reef Fish Observer Program for the Commercial Vertical Line fishery.

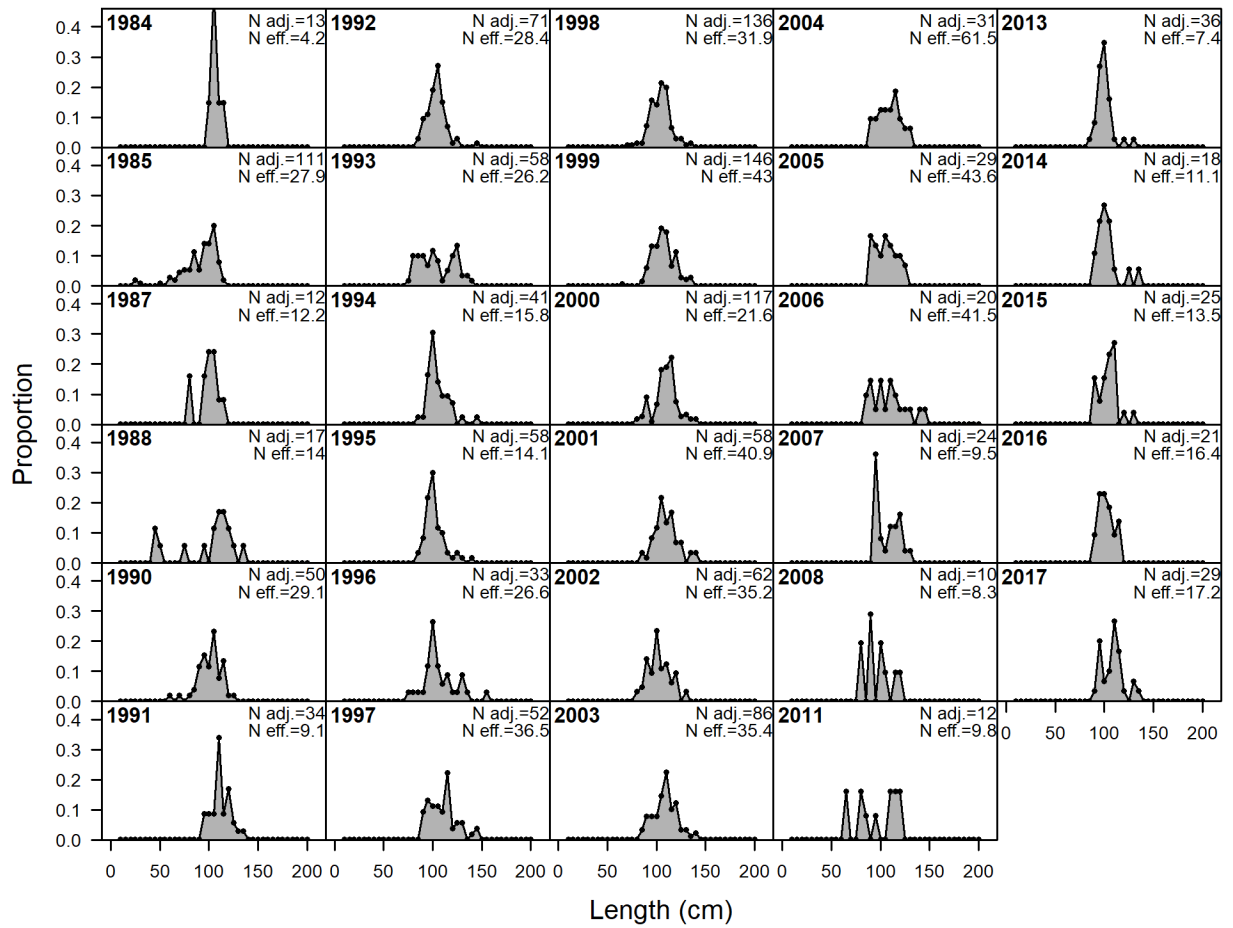

Figure 7. Observed length composition data (retained) of Gulf of Mexico Greater Amberjack in the Commercial Longline fishery.

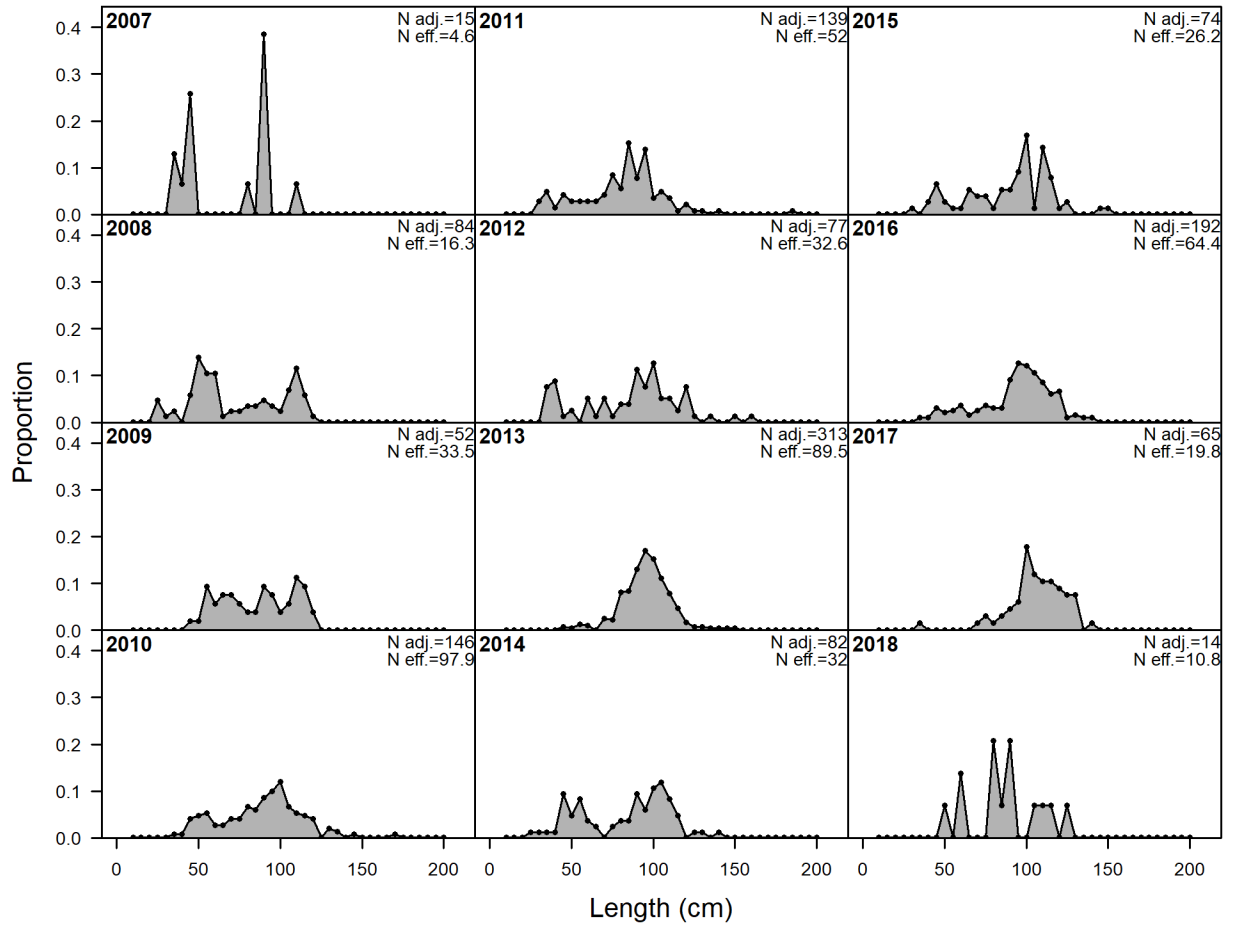

Figure 8. Observed length composition data (discarded) for Gulf of Mexico Greater Amberjack from the Reef Fish Observer Program for the Commercial Longline fishery.

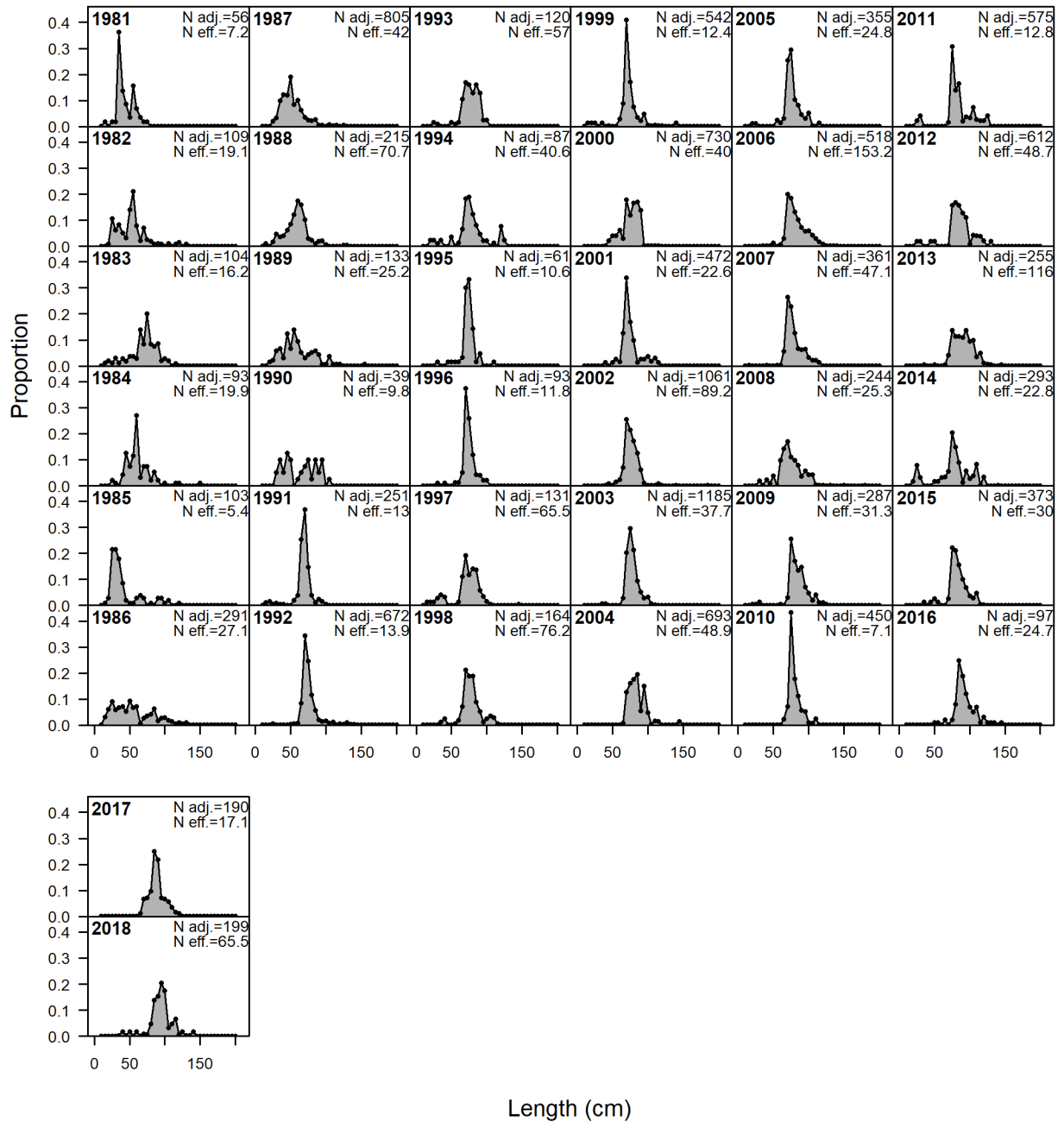

Figure 9. Observed length composition data (retained) of Gulf of Mexico Greater Amberjack in the Recreational Charter Private fishery.

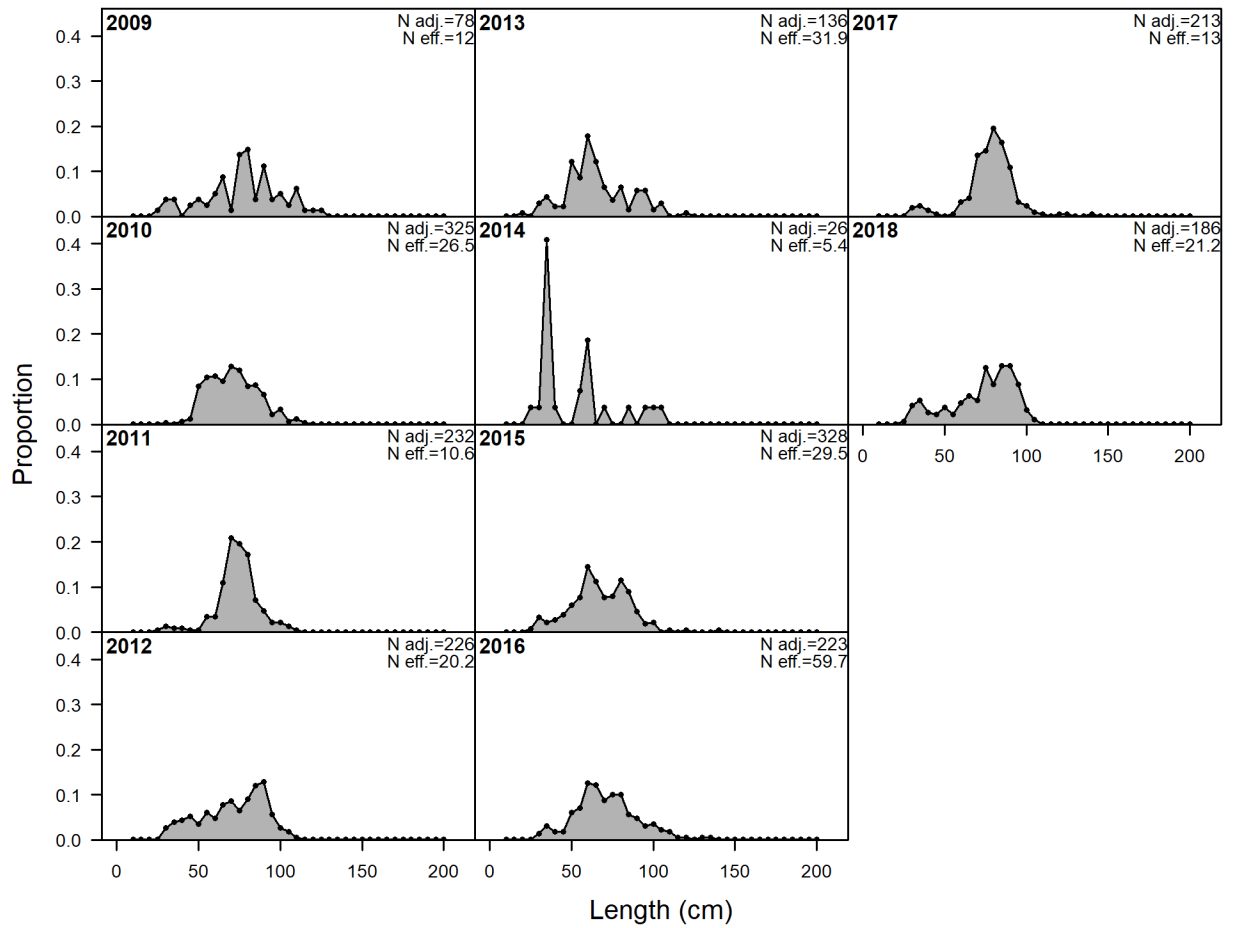

Figure 10. Observed length composition data (discarded) for Gulf of Mexico Greater Amberjack from the FWRI At-Sea Observer Program for the Recreational Charter Private fishery.

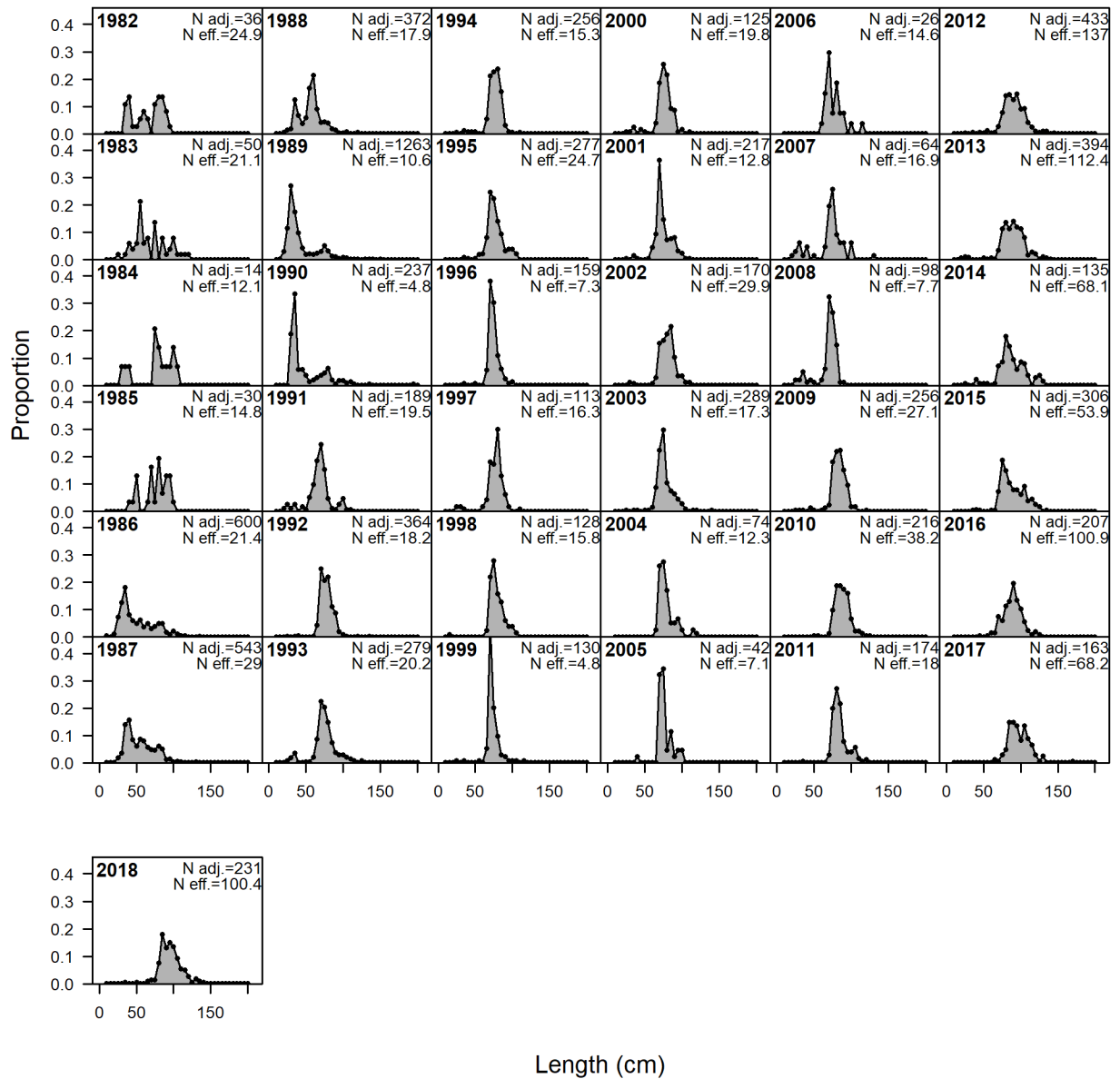

Figure 11. Observed length composition data (retained) of Gulf of Mexico Greater Amberjack in the Recreational Headboat fishery.

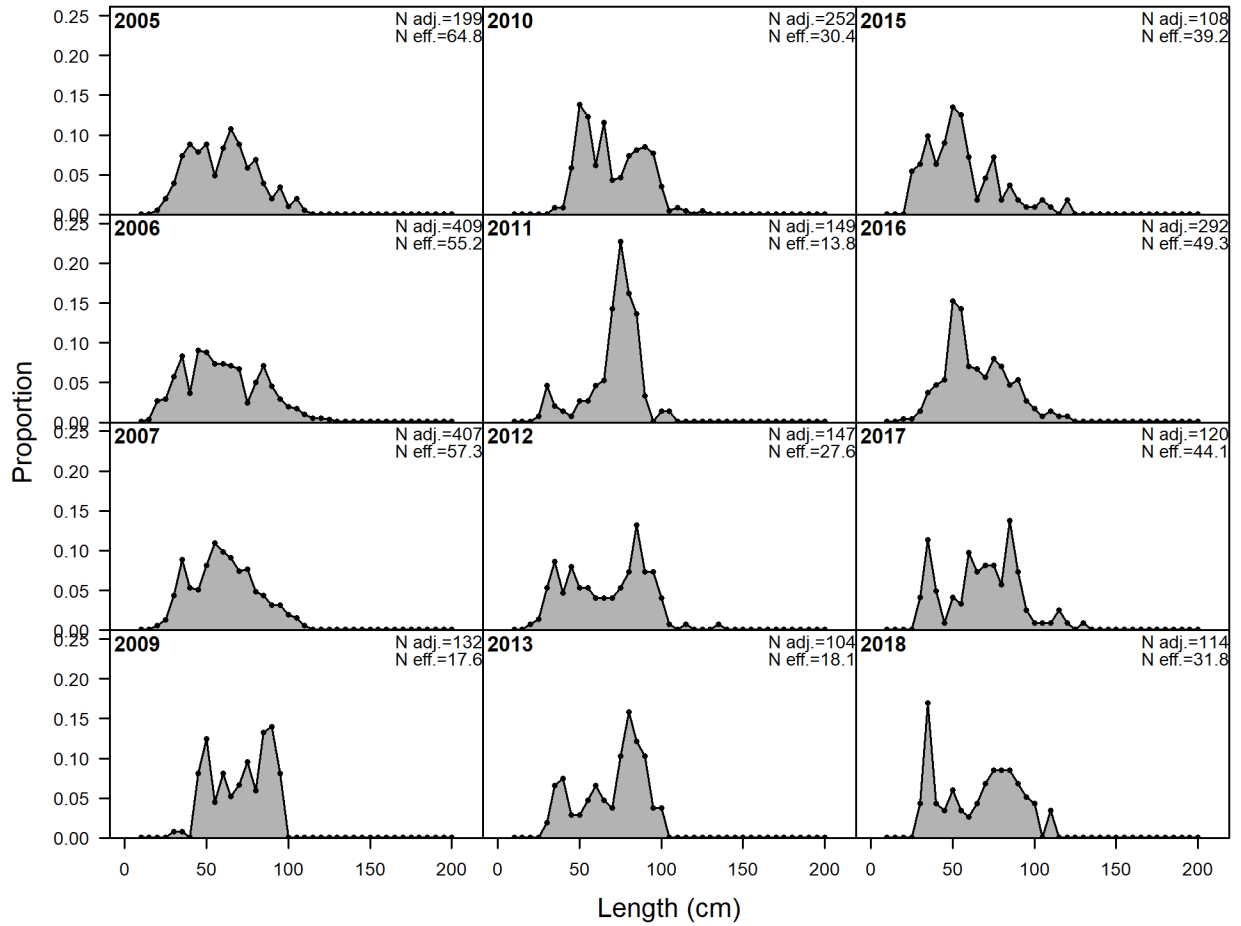

Figure 12. Observed length composition data (discarded) for Gulf of Mexico Greater Amberjack from the FWRI At-Sea Observer Program for the Recreational Headboat fishery.

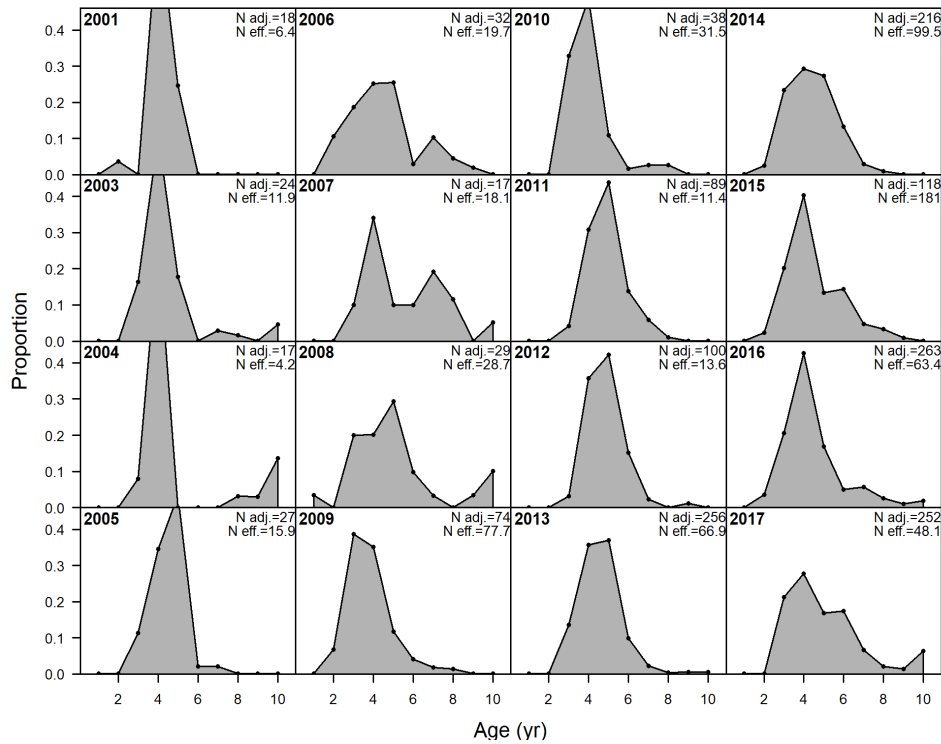

Figure 13. Observed age composition data (retained) for Gulf of Mexico Greater Amberjack in the Commercial Vertical Line fishery.

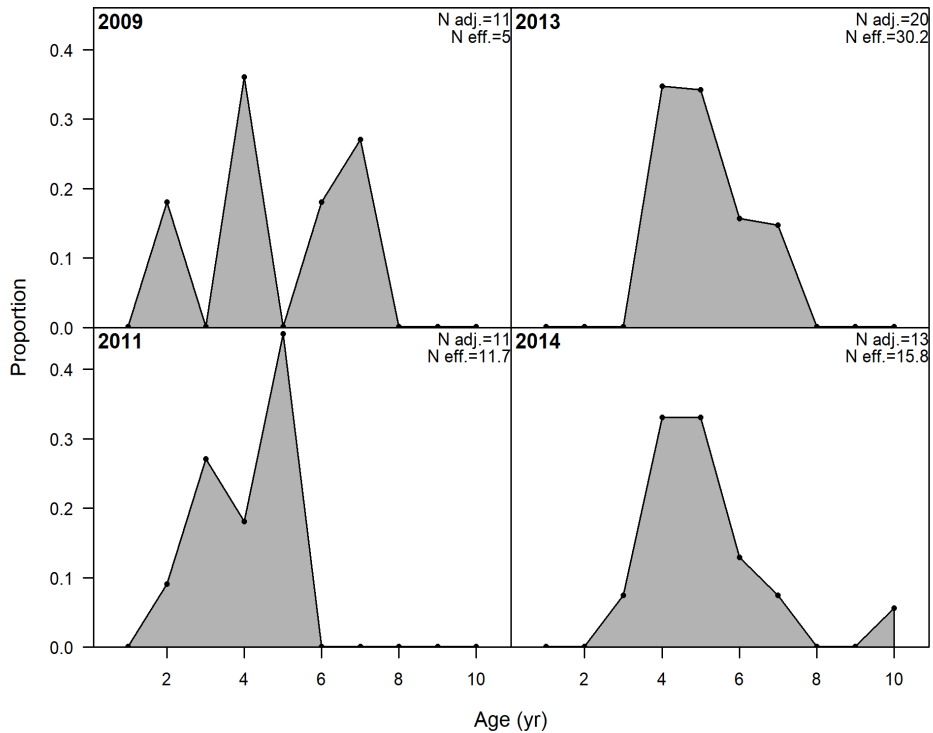

Figure 14. Observed age composition data (retained) for Gulf of Mexico Greater Amberjack in the Commercial Longline fishery.

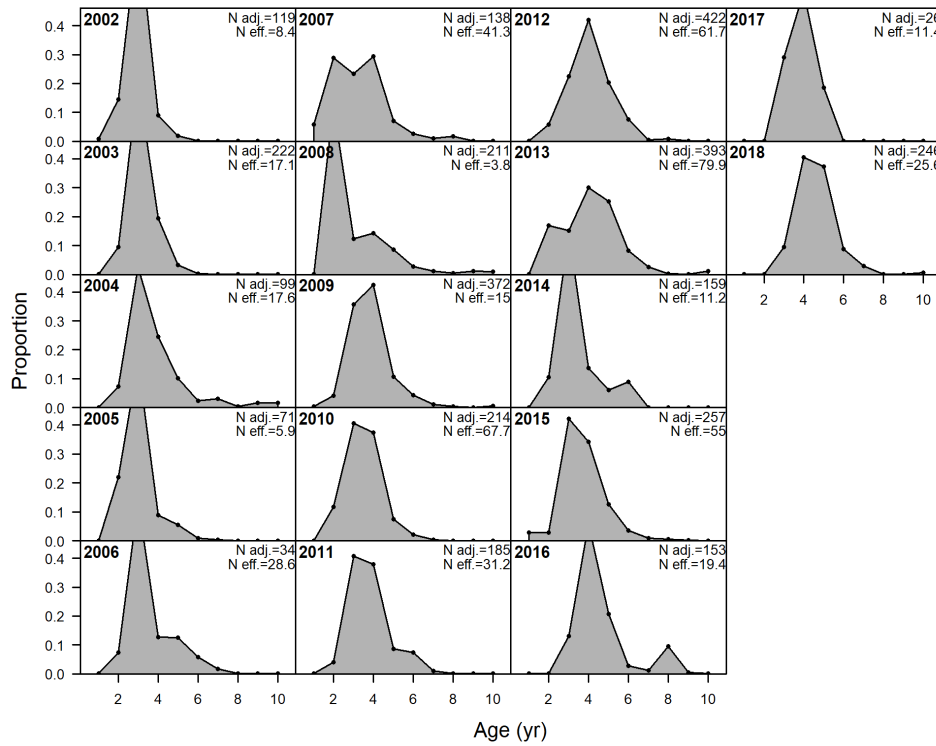

Figure 15. Observed age composition data (retained) for Gulf of Mexico Greater Amberjack in the Recreational Charter Private fishery.

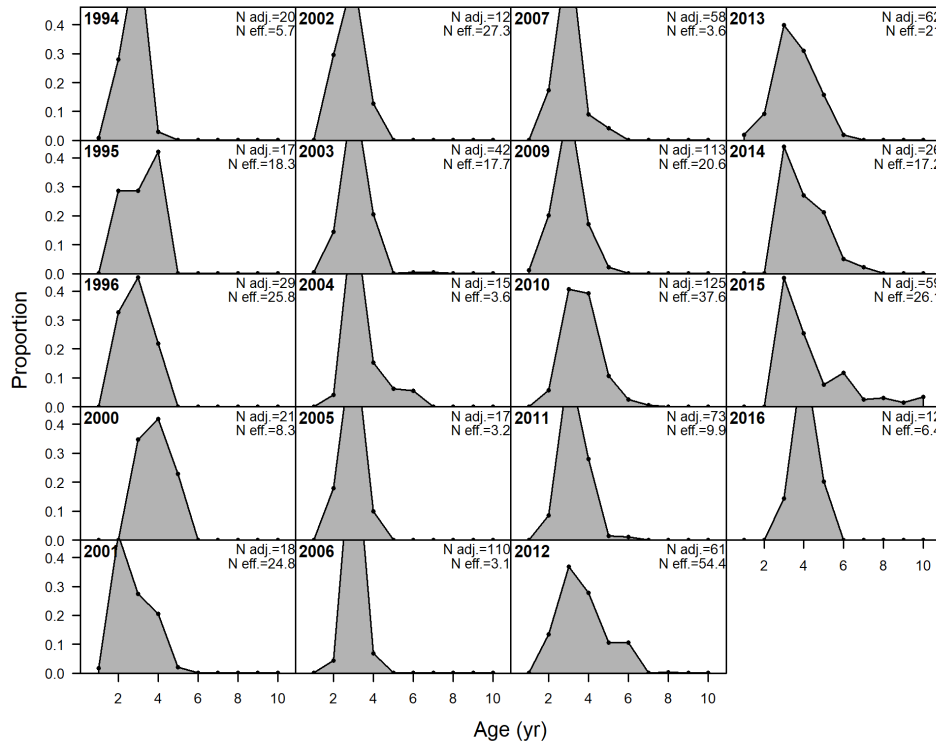

Figure 16. Observed age composition data (retained) for Gulf of Mexico Greater Amberjack in the Recreational Headboat fishery.

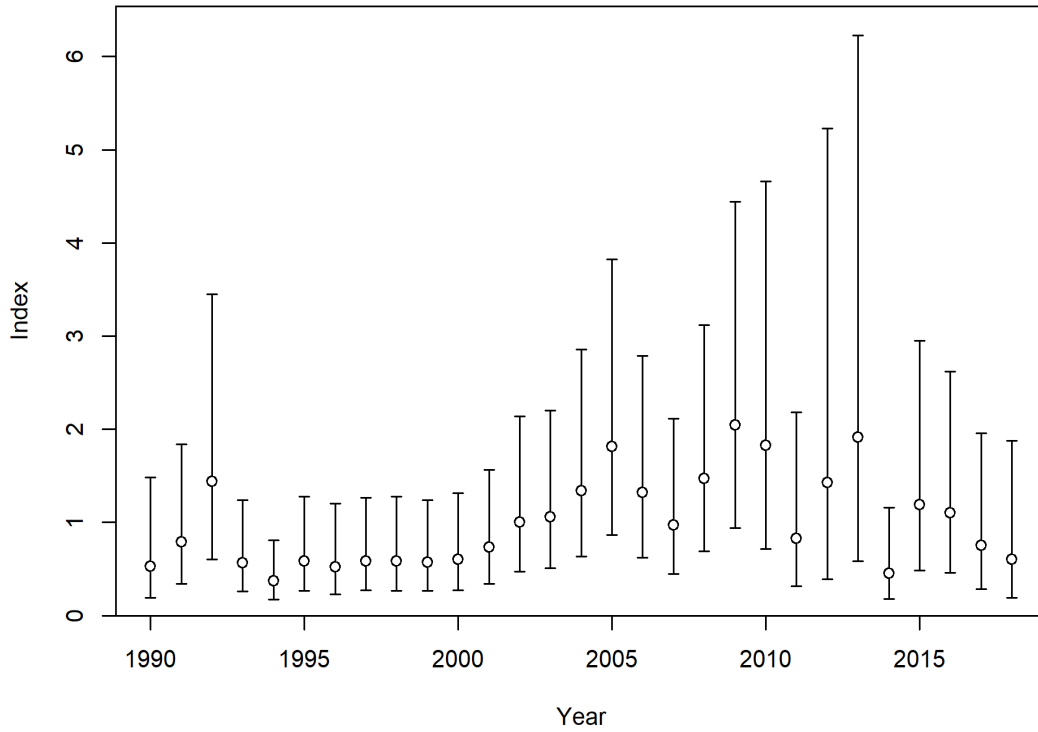

Figure 17. Standardized index of relative abundance and associated standard errors for Gulf of Mexico Greater Amberjack from the Commercial Longline fishery.

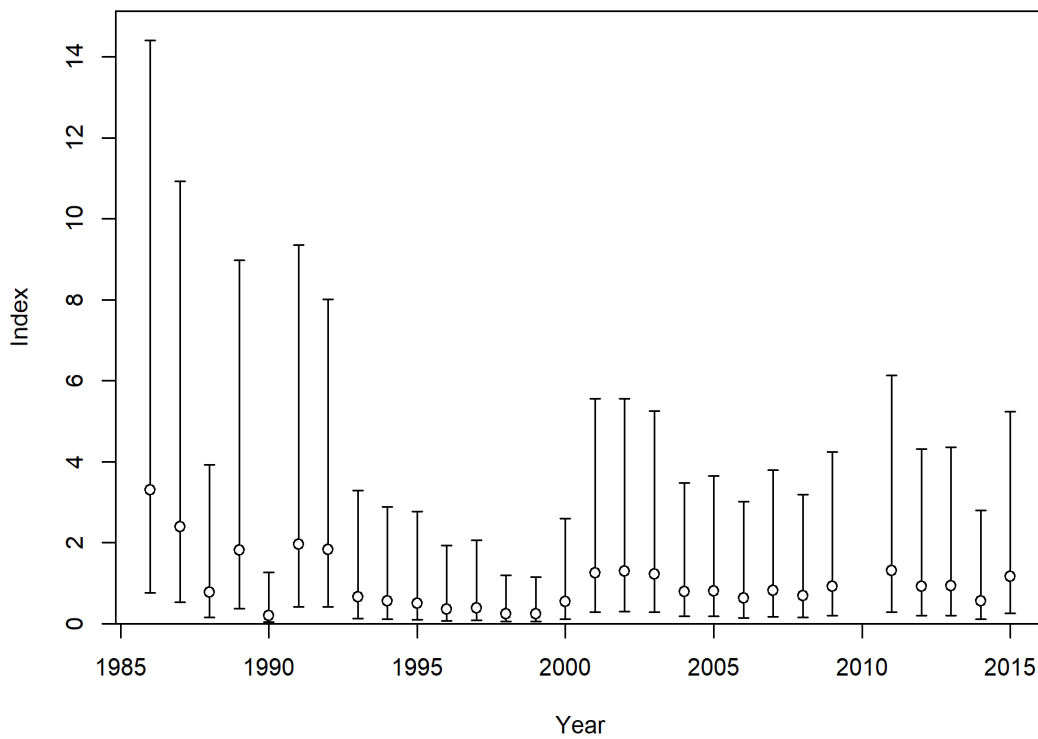

Figure 18. Standardized index of relative abundance and associated standard errors for Gulf of Mexico Greater Amberjack from the Recreational Charter Private fishery.

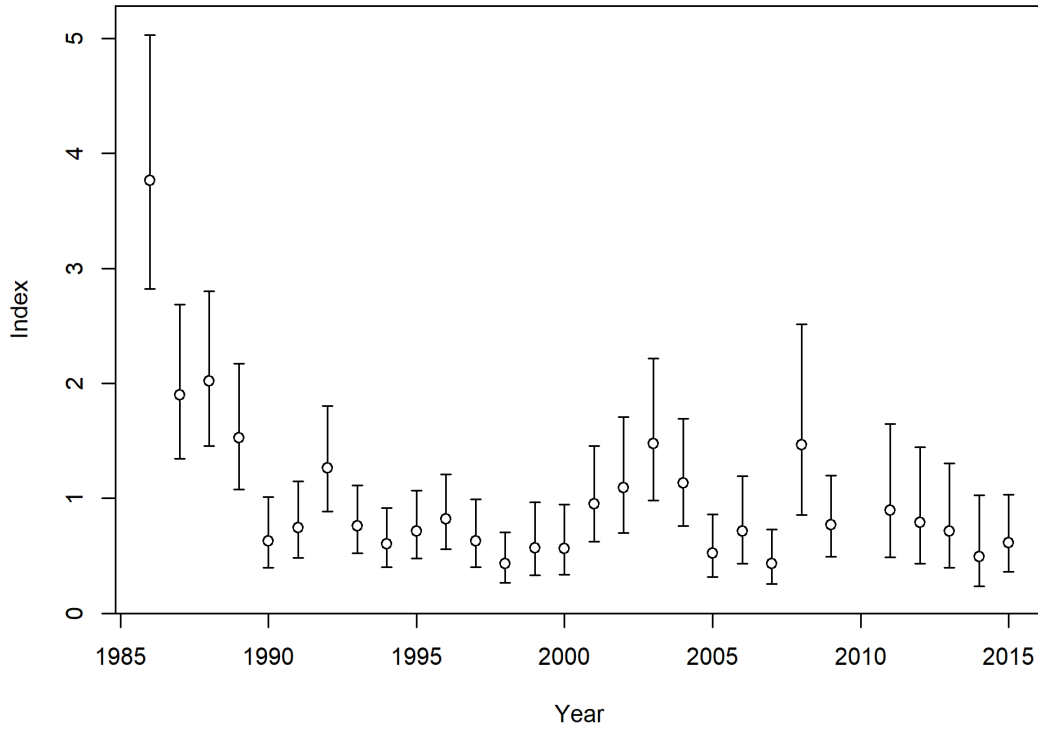

Figure 19. Standardized index of relative abundance and associated standard errors for Gulf of Mexico Greater Amberjack from the Recreational Headboat fishery.

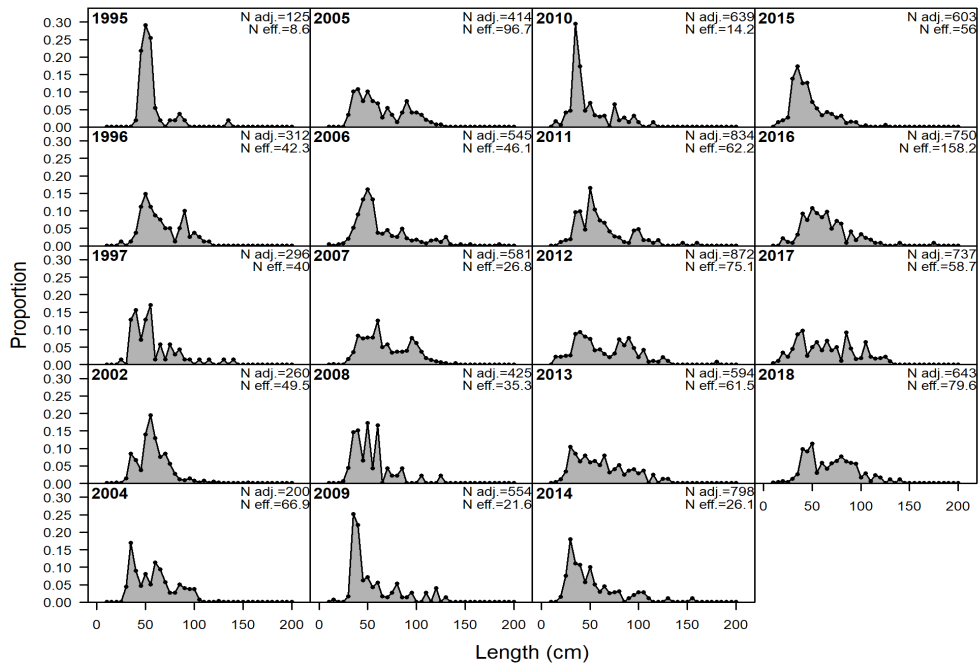

Figure 20. Observed length composition data of Gulf of Mexico Greater Amberjack from the Joint Video Survey.

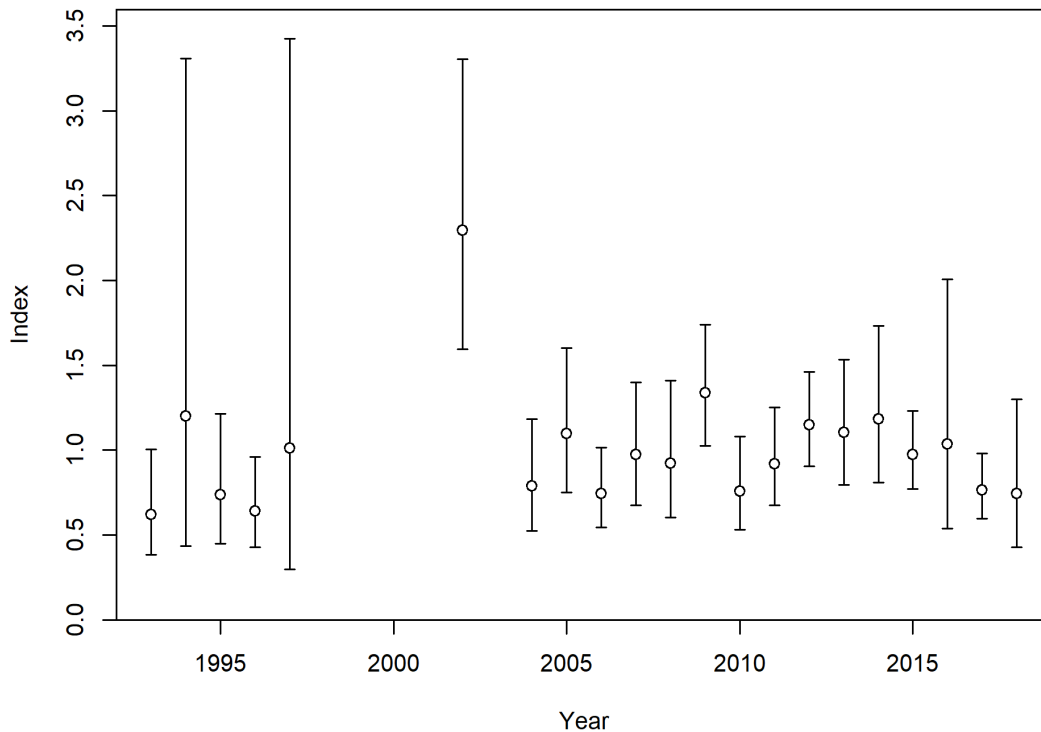

Figure 21. Standardized index of relative abundance and associated standard errors for Gulf of Mexico Greater Amberjack from the Joint Video Survey.

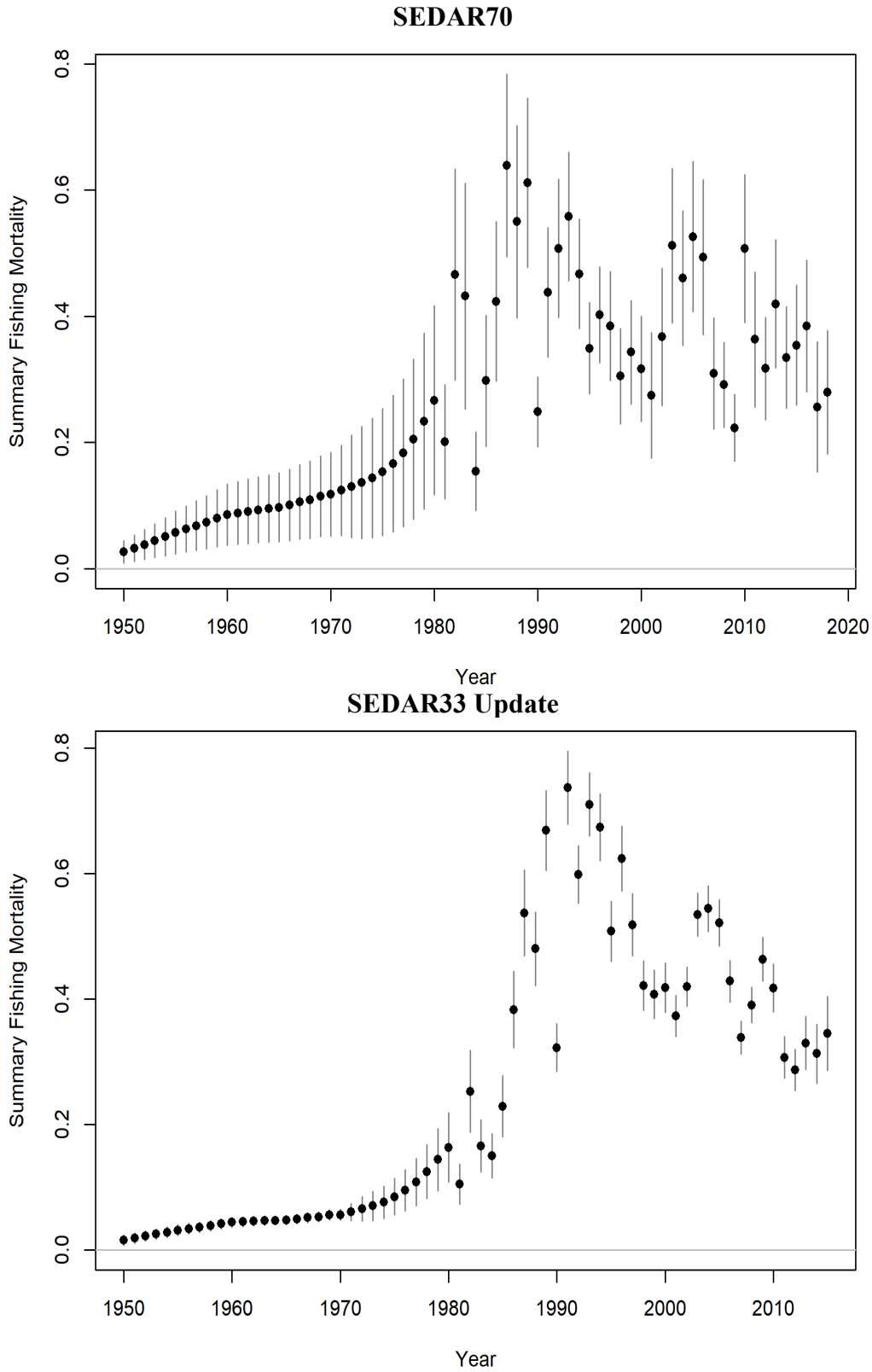

Figure 22. Annual exploitation rate (total kill age 1+/total biomass age 1+) for Gulf of Mexico Greater Amberjack.

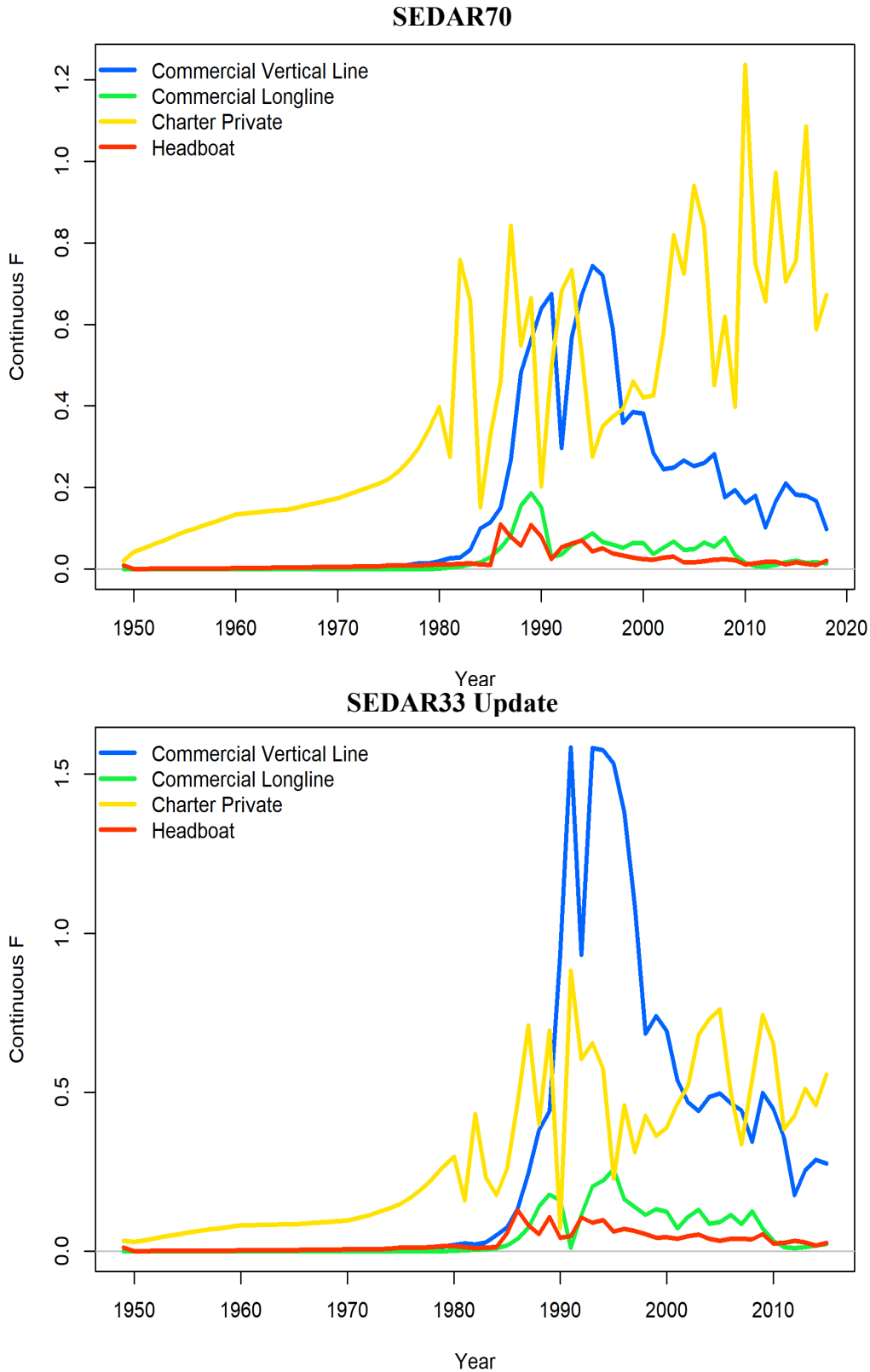

Figure 23. Fleet-specific estimates of instantaneous fishing mortality rate in terms of exploitable biomass for Gulf of Mexico Greater Amberjack.

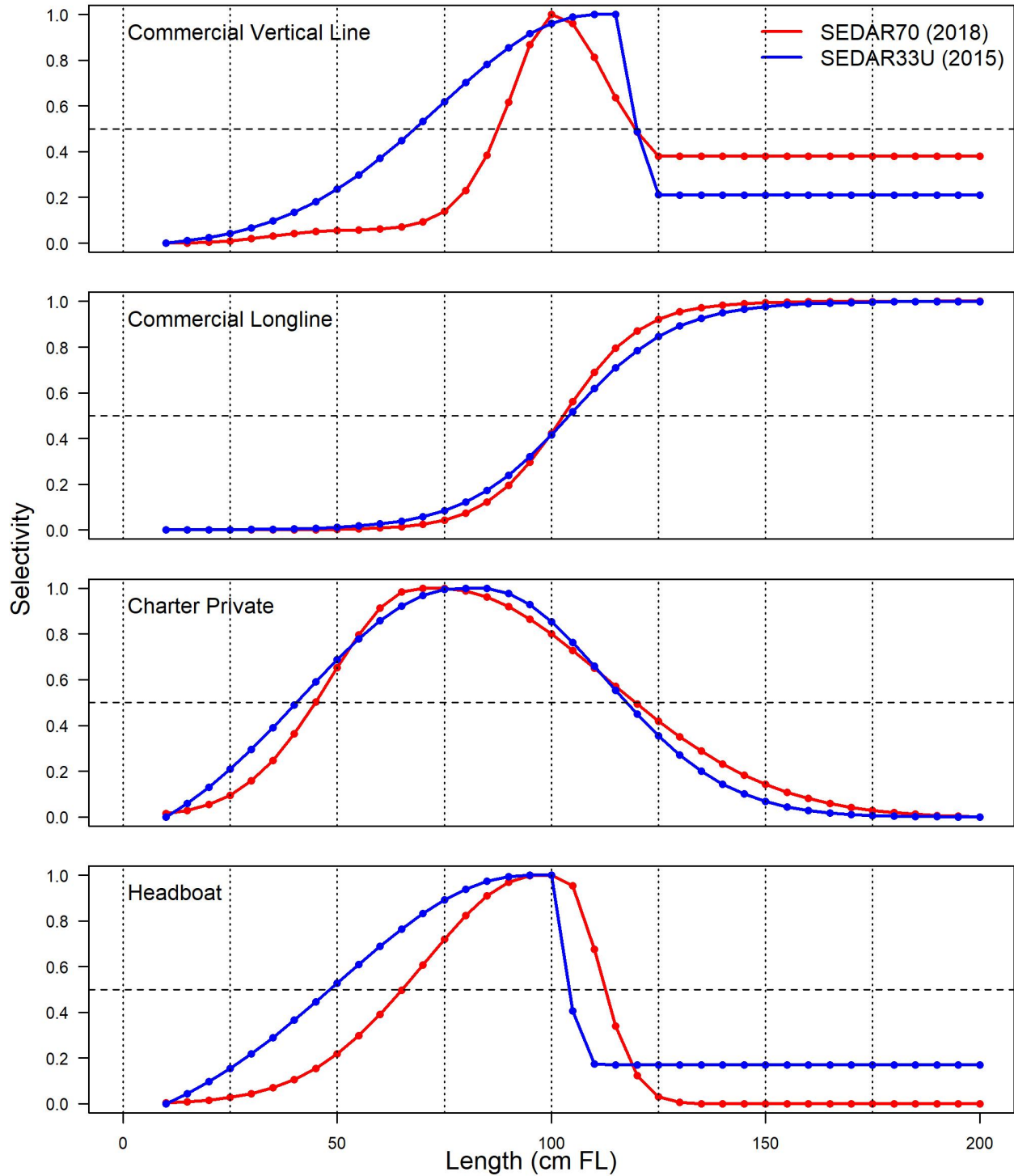

Figure 24. Length-based selectivity for each fleet for Gulf of Mexico Greater Amberjack in the terminal year of the assessment (given in parentheses). Dashed horizontal line indicates 50%, whereas the dashed vertical lines identify lengths in 25 cm FL intervals.

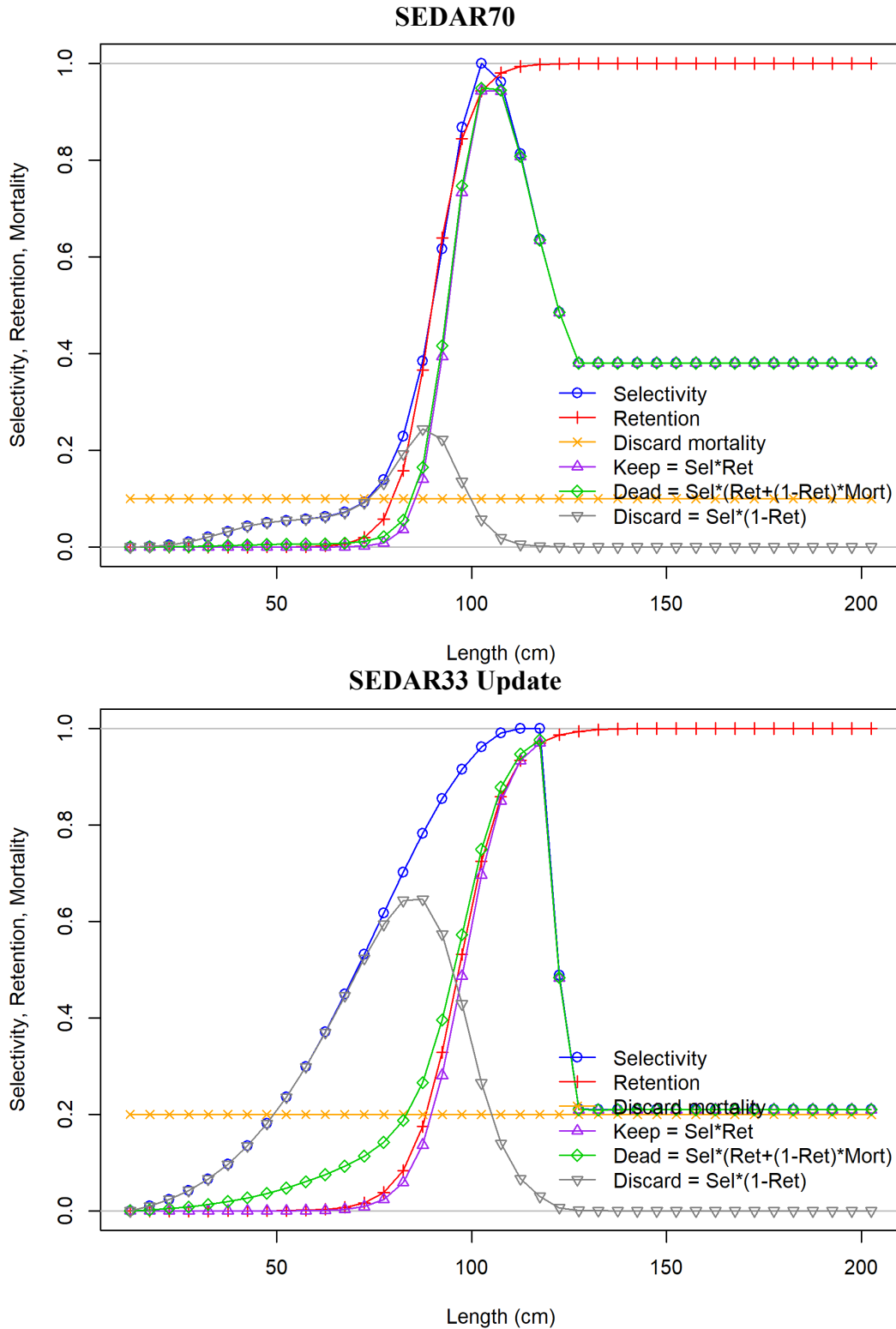

Figure 25. Length-based selectivity for the Commercial Vertical Line fishery. Selectivity (blue line) is constant over the entire assessment time period (1950 - 2018). Retention (red line) is shown for the most recent time period. Discard mortality (orange line) is constant at 0.1.

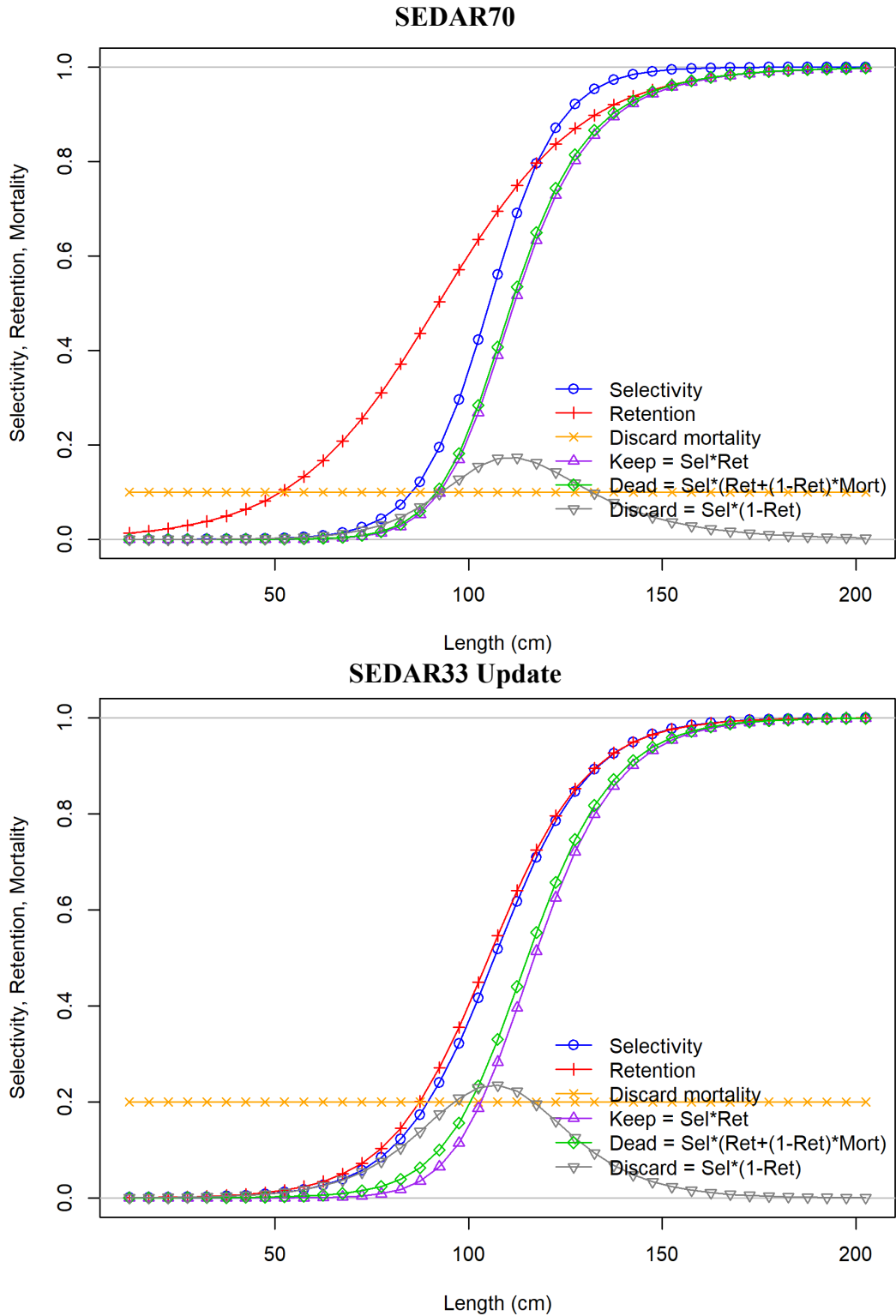

Figure 26. Length-based selectivity for the Commercial Longline fishery. Selectivity (blue line) is constant over the entire assessment time period (1950 - 2018). Retention (red line) is shown for the most recent time period. Discard mortality (orange line) is constant at 0.1.

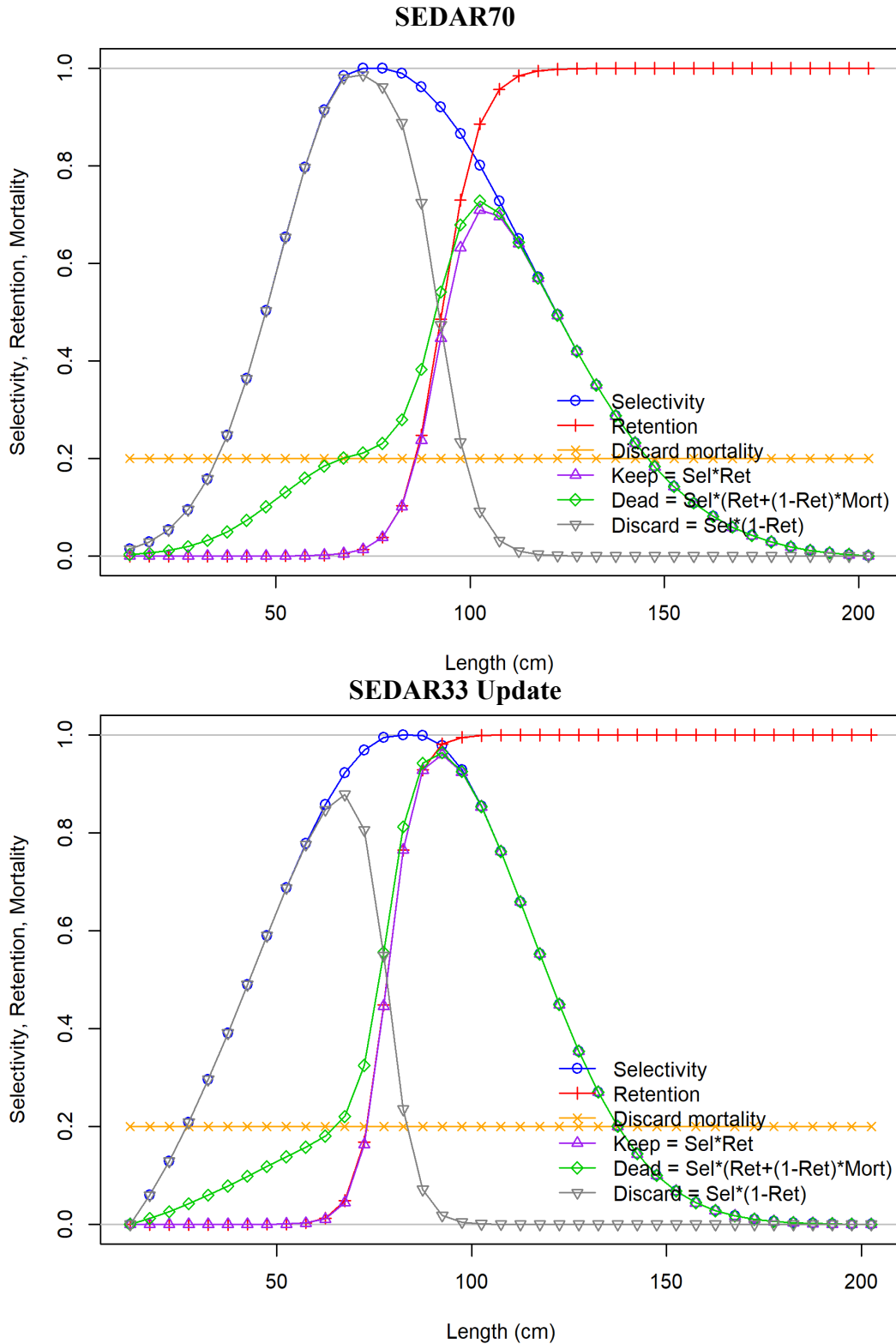

Figure 27. Length-based selectivity for the Recreational Charter Private fishery. Selectivity (blue line) is constant over the entire assessment time period (1950 - 2018). Retention (red line) is shown for the most recent time period. Discard mortality (orange line) is constant at 0.2.

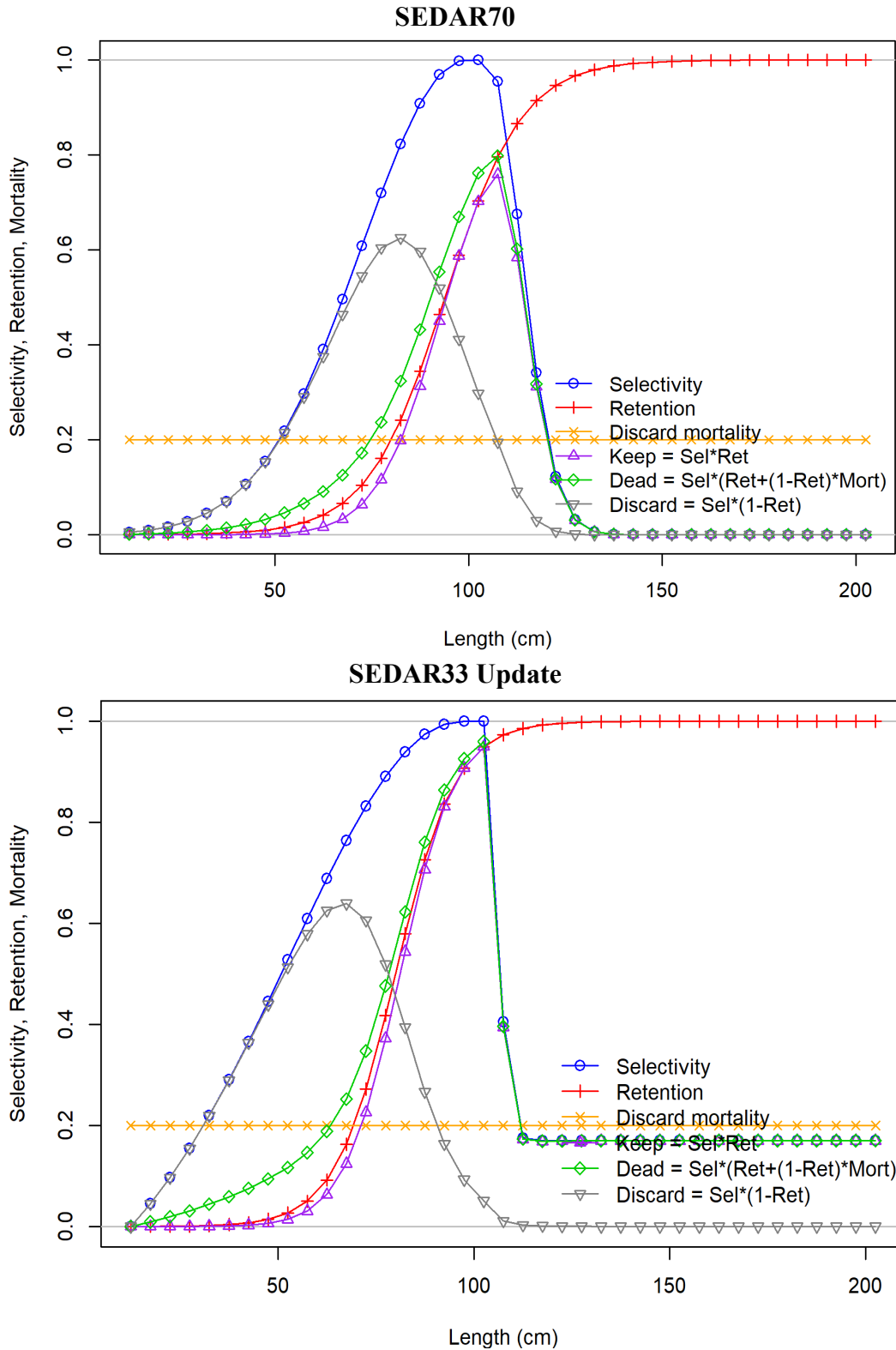

Figure 28. Length-based selectivity for the Recreational Headboat fishery. Selectivity (blue line) is constant over the entire assessment time period (1950 - 2018). Retention (red line) is shown for the most recent time period. Discard mortality (orange line) is constant at 0.2.

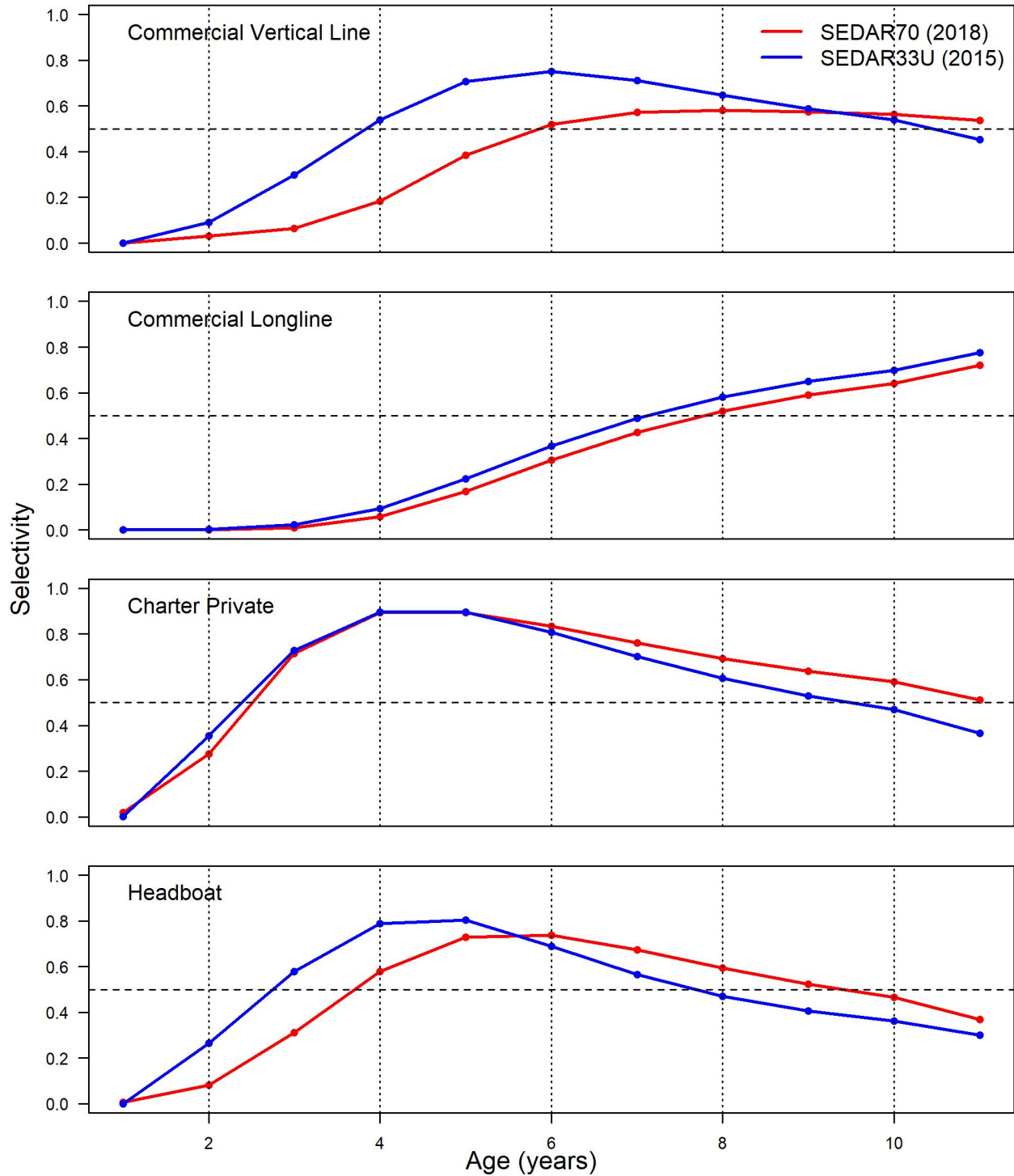

Figure 29. Derived age-based selectivity for each fleet for Gulf of Mexico Greater Amberjack in the terminal year of the assessment (given in parentheses). Dashed horizontal line indicates 50%, whereas the dashed vertical lines identify ages in two-year intervals.

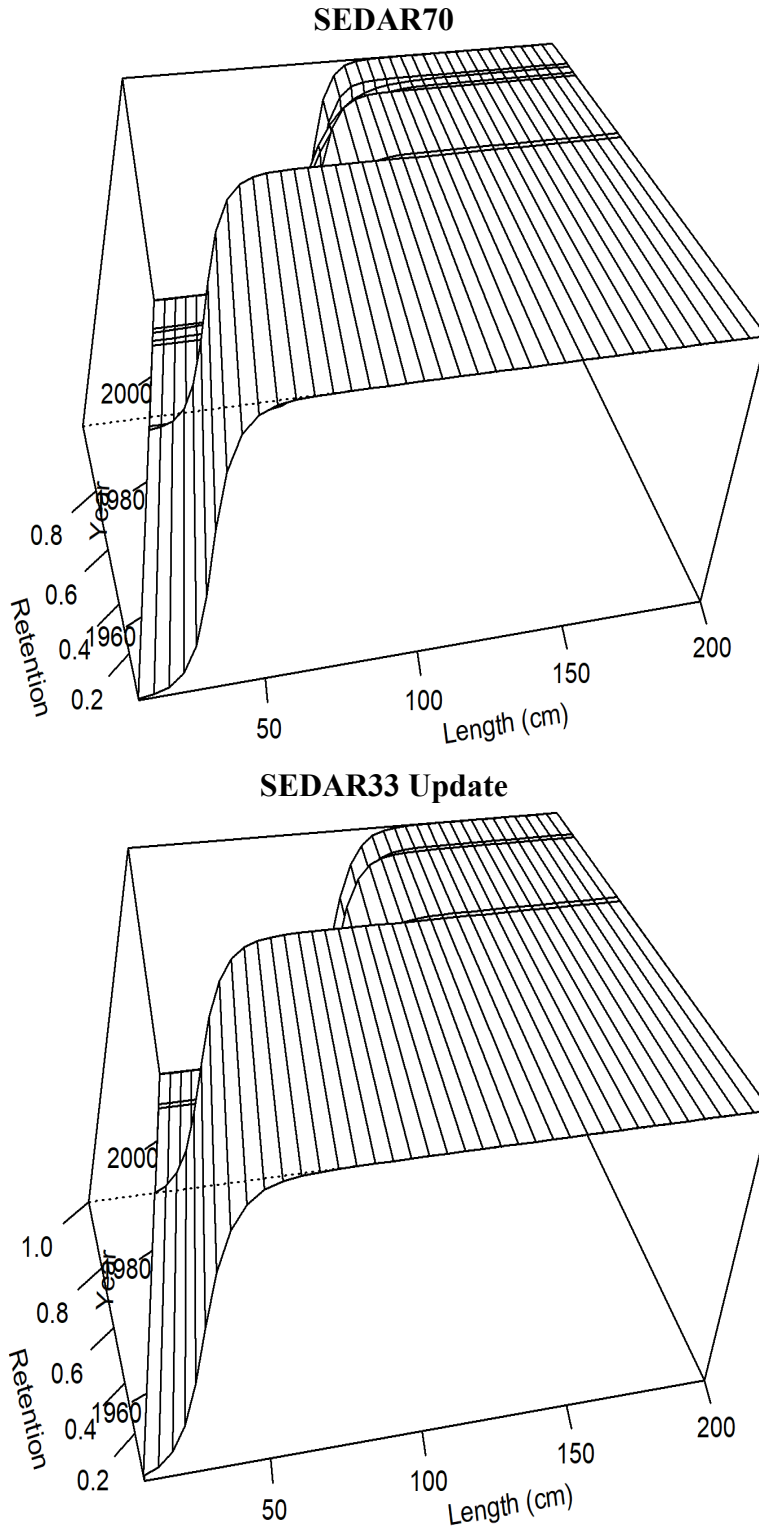

Figure 30. Time-varying retention at length for the Commercial Vertical Line fishery for Gulf of Mexico Greater Amberjack from SEDAR70 (Upper Panel) and SEDAR33 Update (Lower Panel).

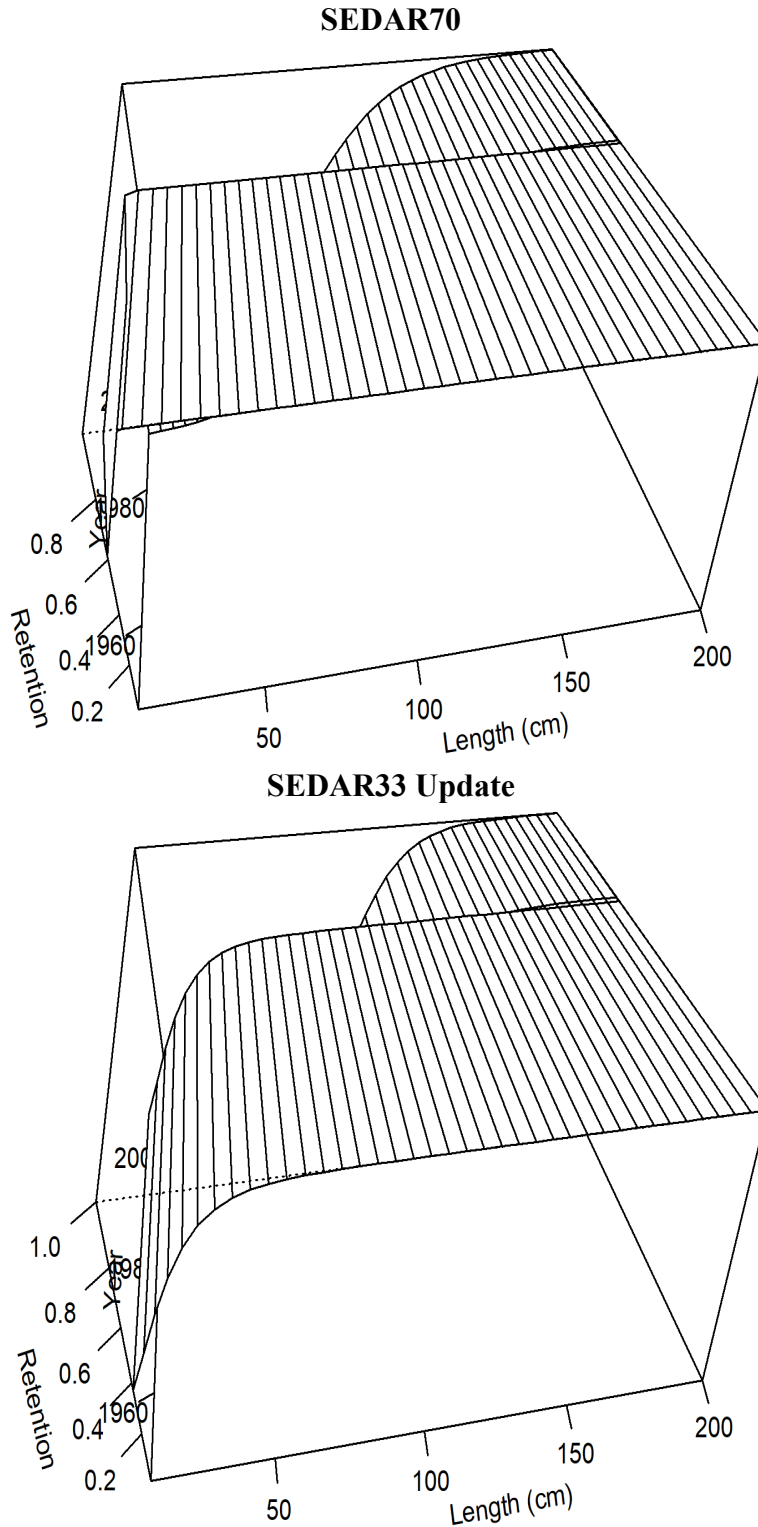

Figure 31. Time-varying retention at length for the Commercial Longline fishery for Gulf of Mexico Greater Amberjack from SEDAR70 (Upper Panel) and SEDAR33 Update (Lower Panel).

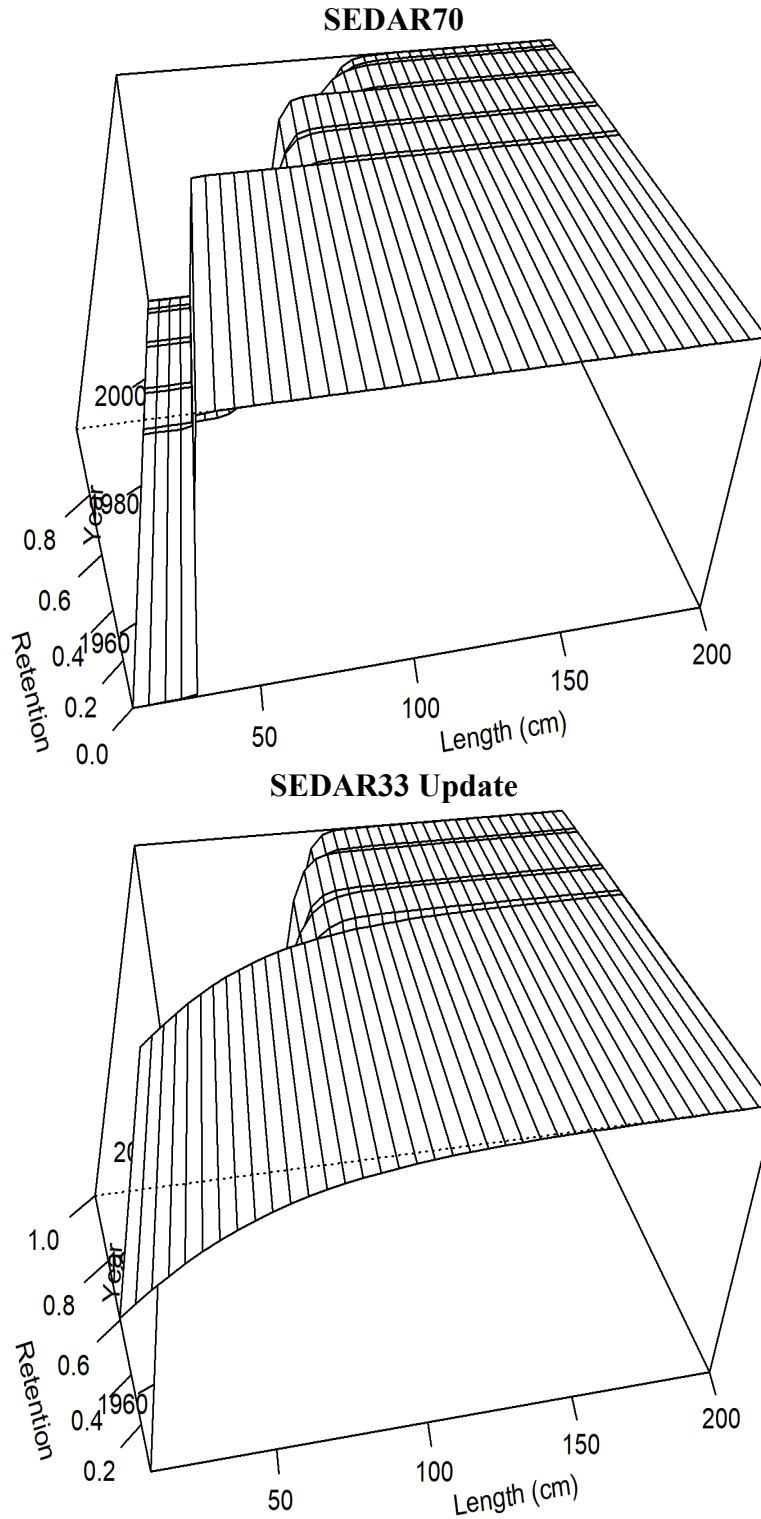

Figure 32. Time-varying retention at length for the Recreational Charter Private fishery for Gulf of Mexico Greater Amberjack from SEDAR70 (Upper Panel) and SEDAR33 Update (Lower Panel).

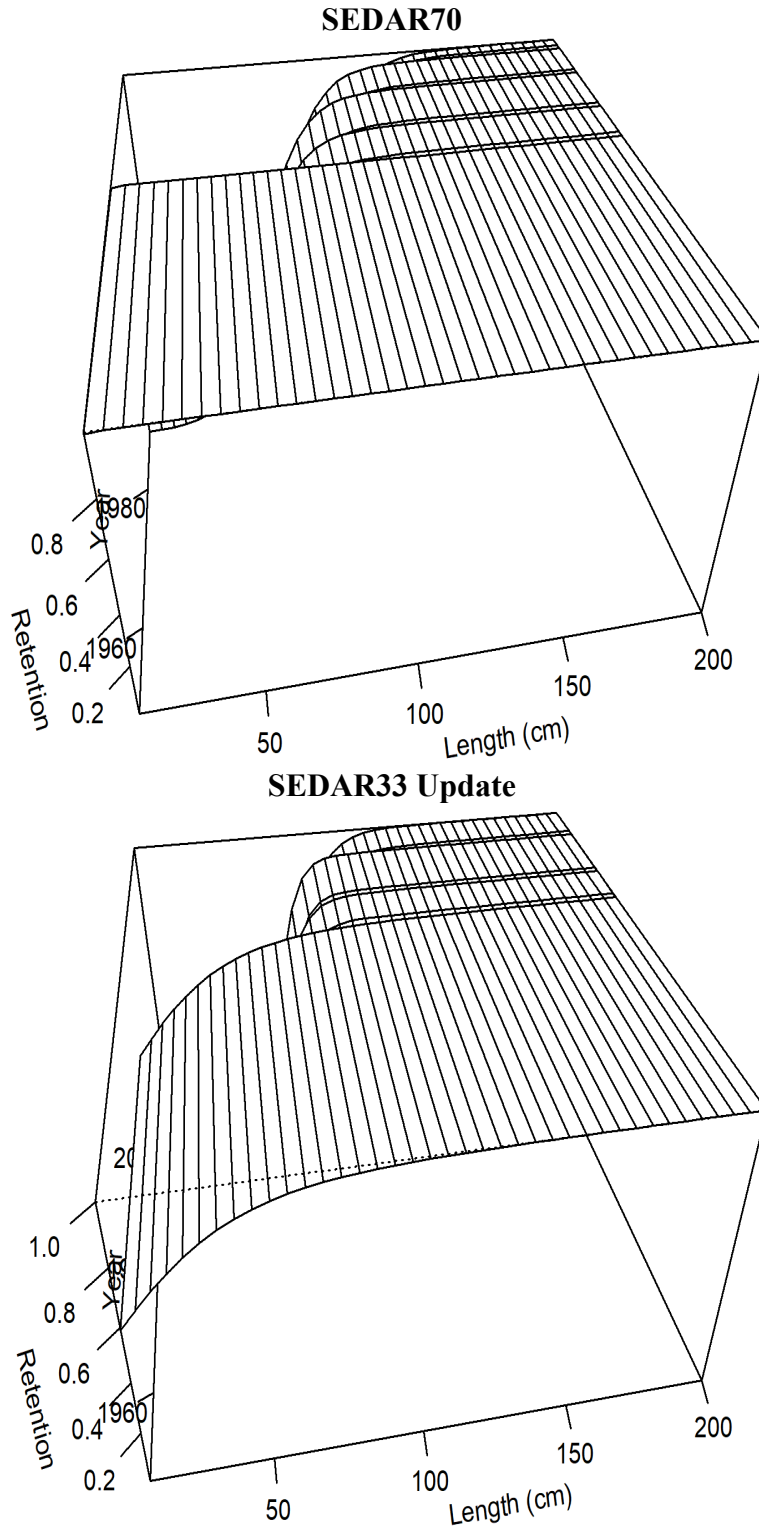

Figure 33. Time-varying retention at length for the Recreational Headboat fishery for Gulf of Mexico Greater Amberjack from SEDAR70 (Upper Panel) and SEDAR33 Update (Lower Panel).

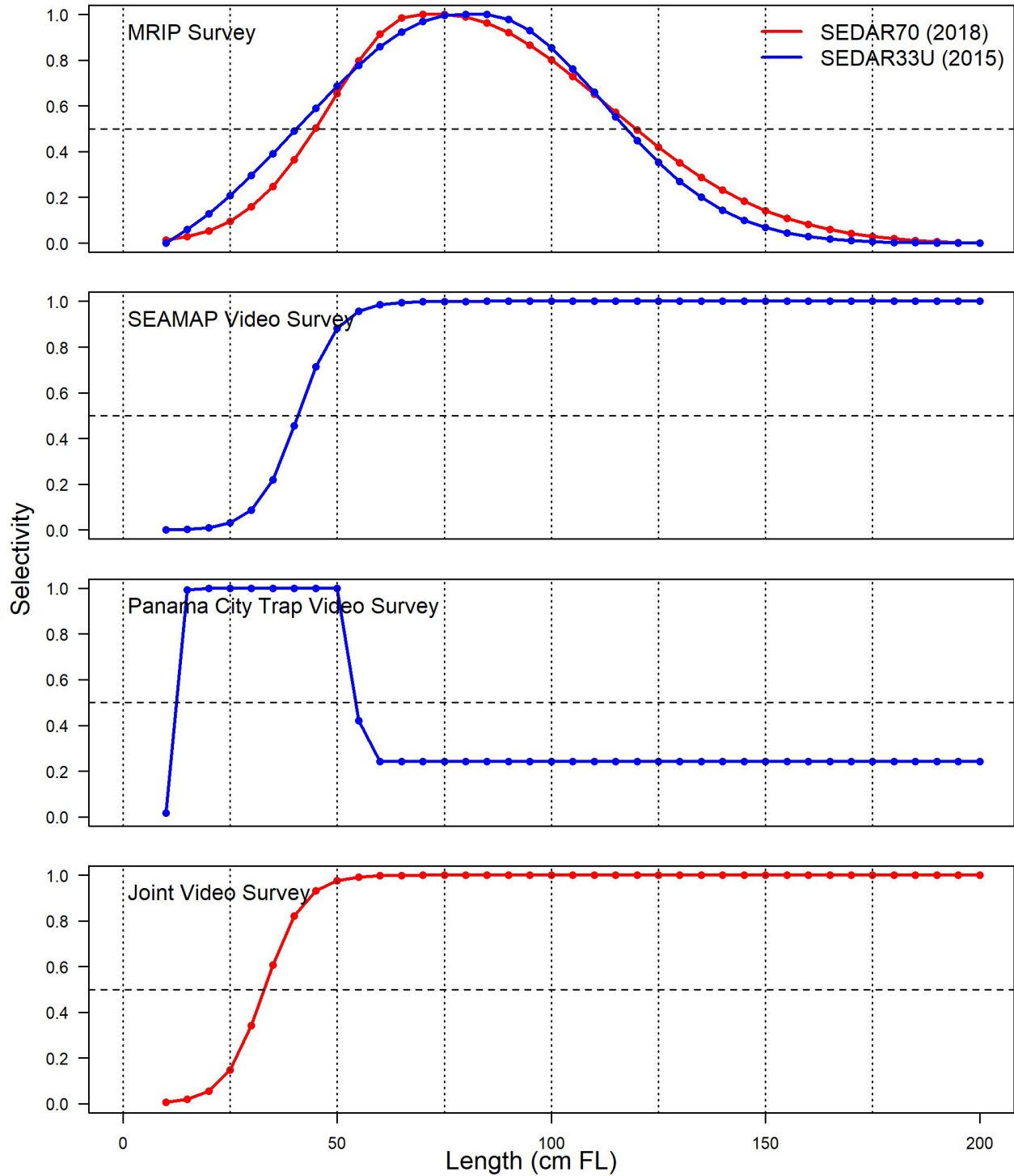

Figure 34a. Length-based selectivity for each survey for Gulf of Mexico Greater Amberjack in the terminal year of the assessment (given in parentheses). Dashed horizontal line indicates 50%, whereas the dashed vertical lines identify lengths in 25 cm FL intervals.

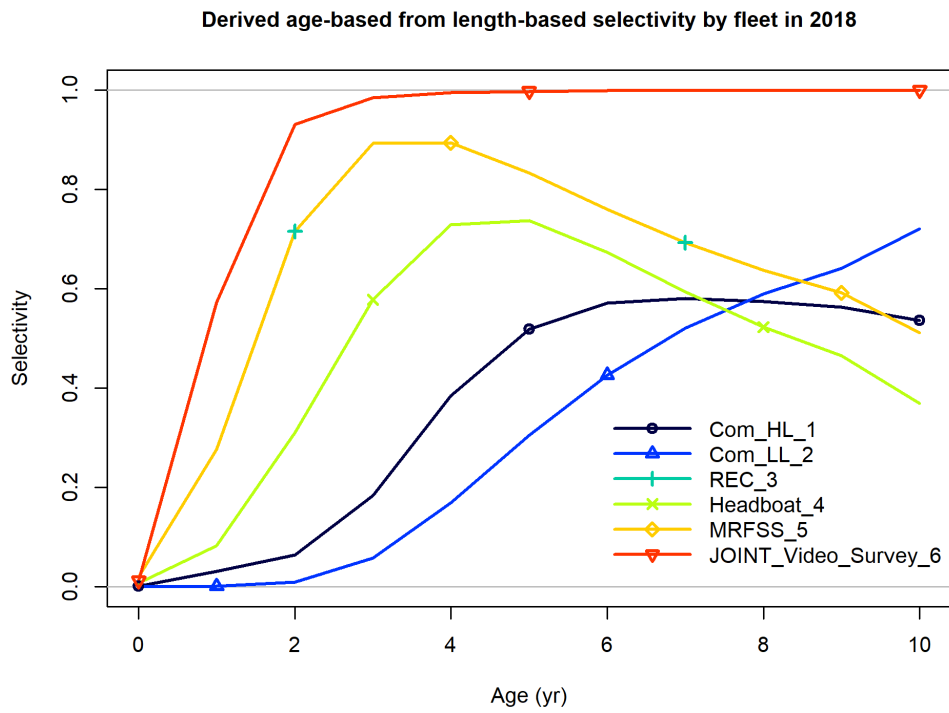

Figure 34b. Selectivity at age derived from selectivity at length for multiple fleets For Gulf of Mexico Greater Amberjack.

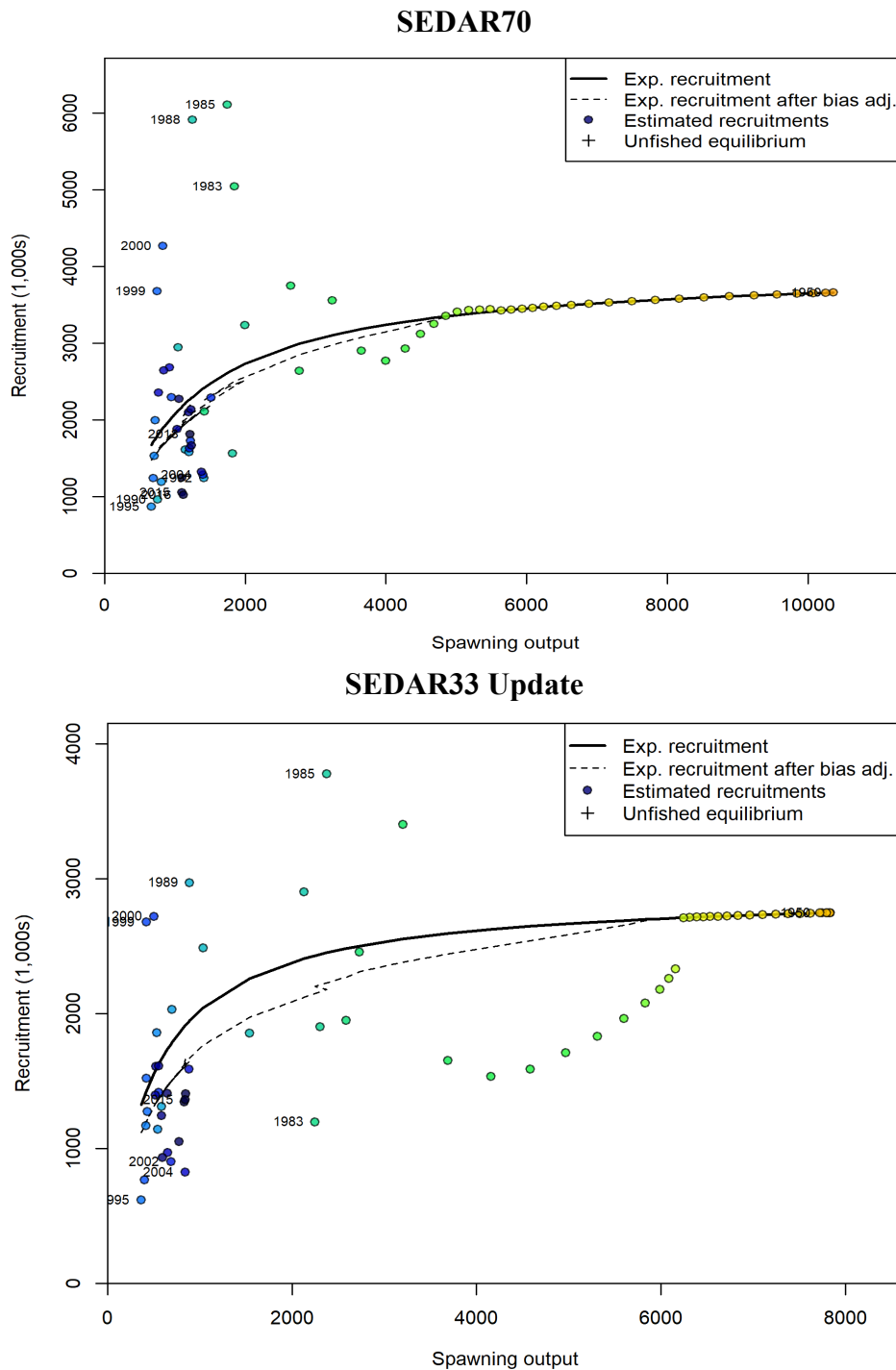

Figure 35. Predicted stock-recruitment relationship for Gulf of Mexico Greater Amberjack (steepness and SigmaR were fixed at 0.777 and 0.524, respectively, which were the estimates from the base run). Plotted are predicted annual recruitments from Stock Synthesis (circles), expected recruitment from the stock-recruit relationship (black line), and bias adjusted recruitment from the stock-recruit relationship (green line).

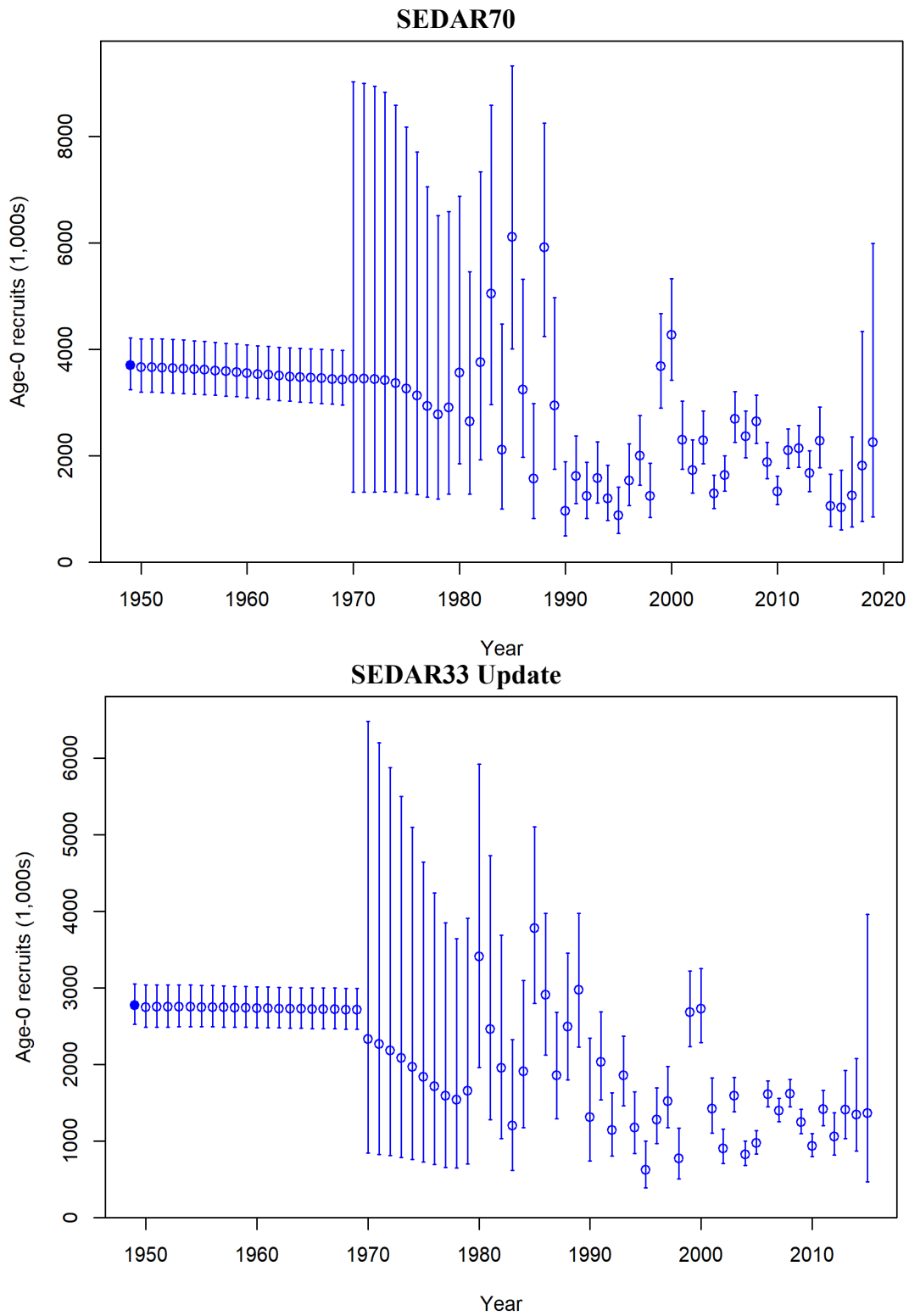

Figure 36. Estimated Age-0 recruitment with 95% confidence intervals for Gulf of Mexico Greater Amberjack (steepness and SigmaR were fixed at 0.777 and 0.524, respectively, which were the estimates from the base run).

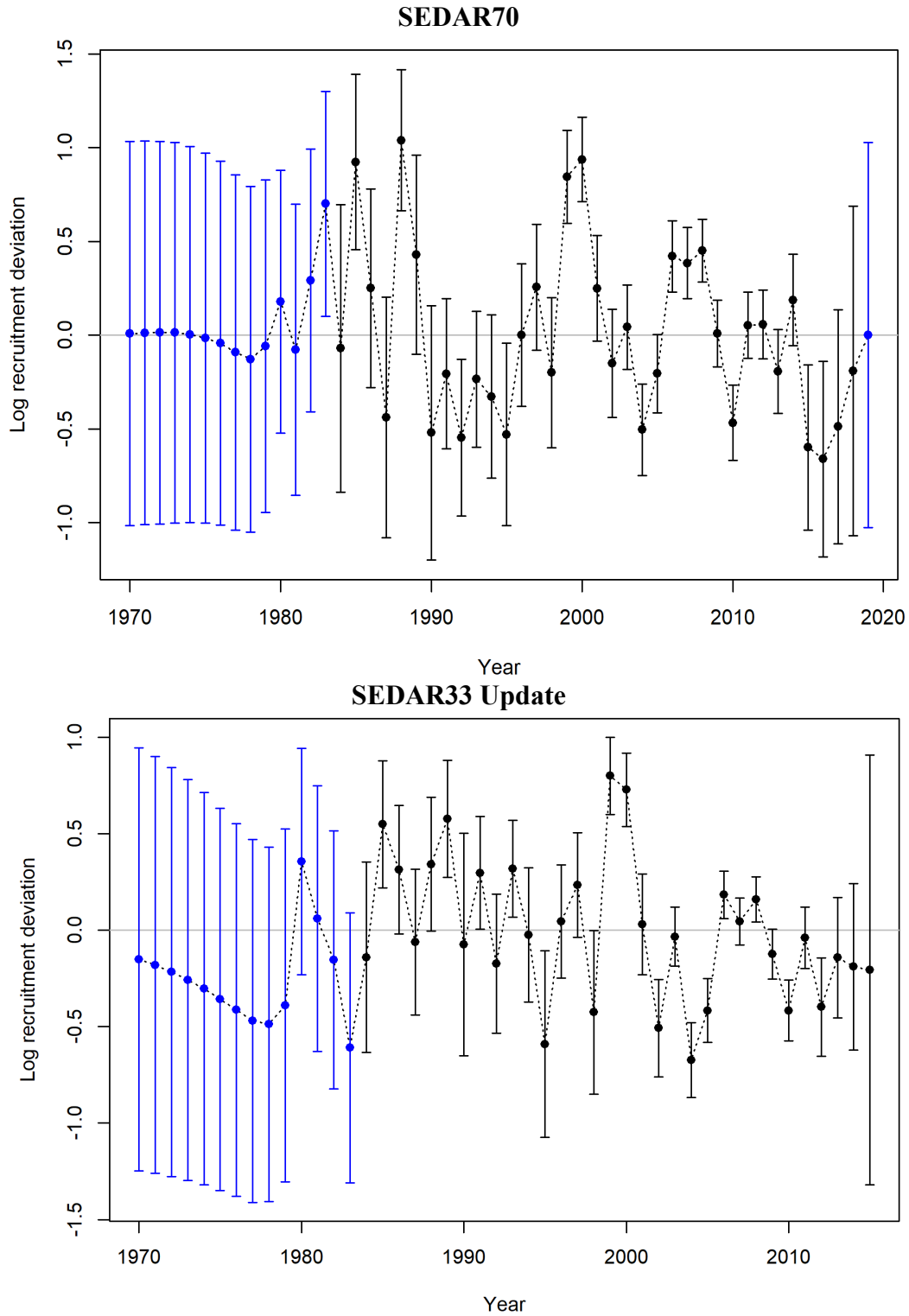

Figure 37. Estimated log recruitment deviations for Gulf of Mexico Greater Amberjack (steepness and SigmaR were fixed at 0.777 and 0.524, respectively, which were the estimates from the base run).

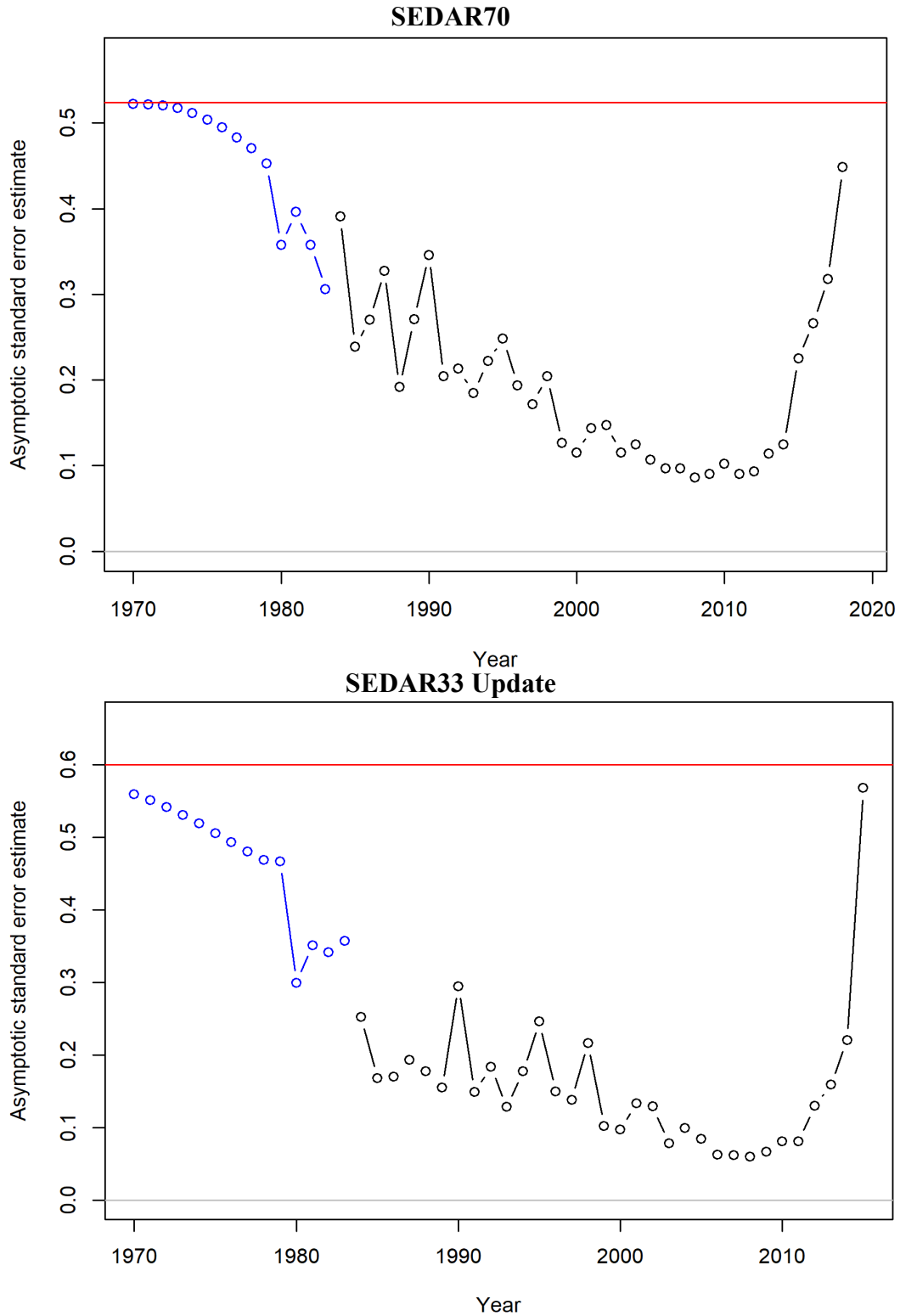

Figure 38. Asymptotic standard errors for recruitment deviations for Gulf of Mexico Greater Amberjack. The red line represents the fixed value of 0.524, which was the estimate from the base run, and the fixed value of 0.6 for the SEDAR70 and SEDAR33 Update models, respectively.

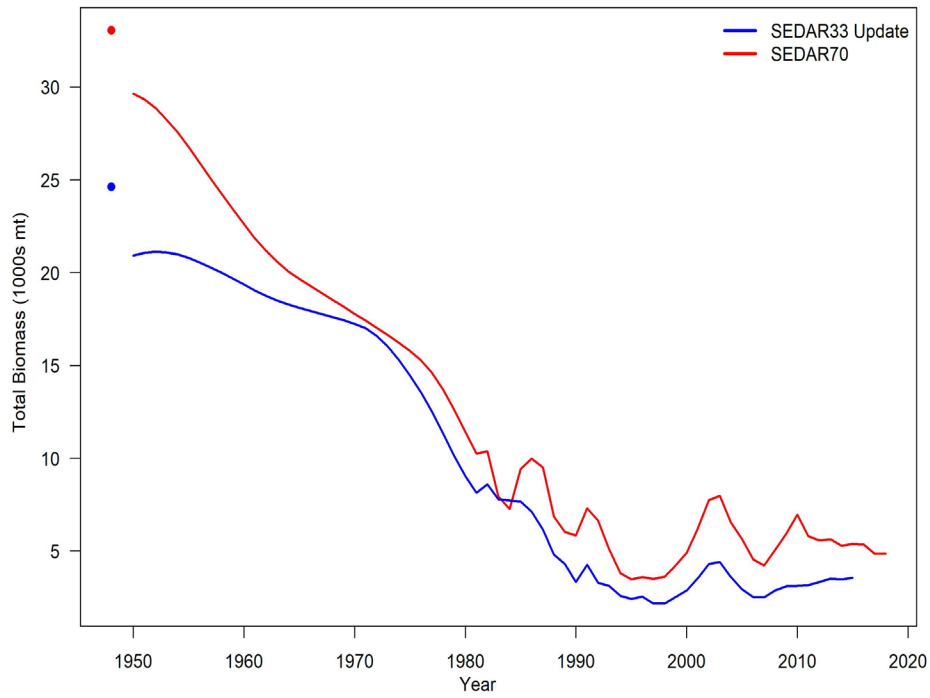

Figure 39. Estimate of total biomass (in 1000s of metric tons) for Gulf of Mexico Greater Amberjack.

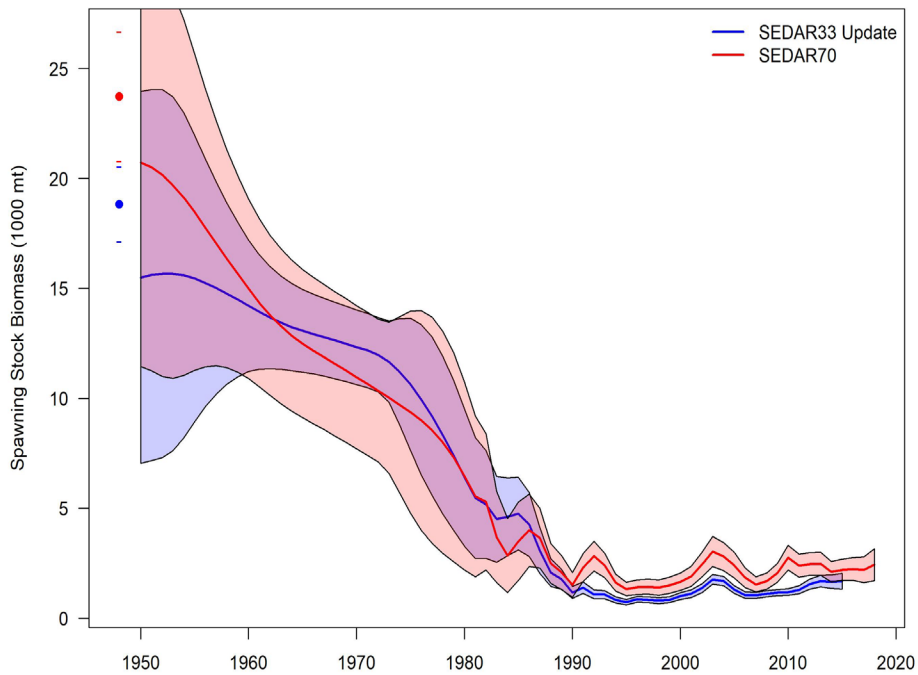

Figure 40. Estimate of spawning stock biomass (in 1000s of metric tons) for Gulf of Mexico Greater Amberjack.

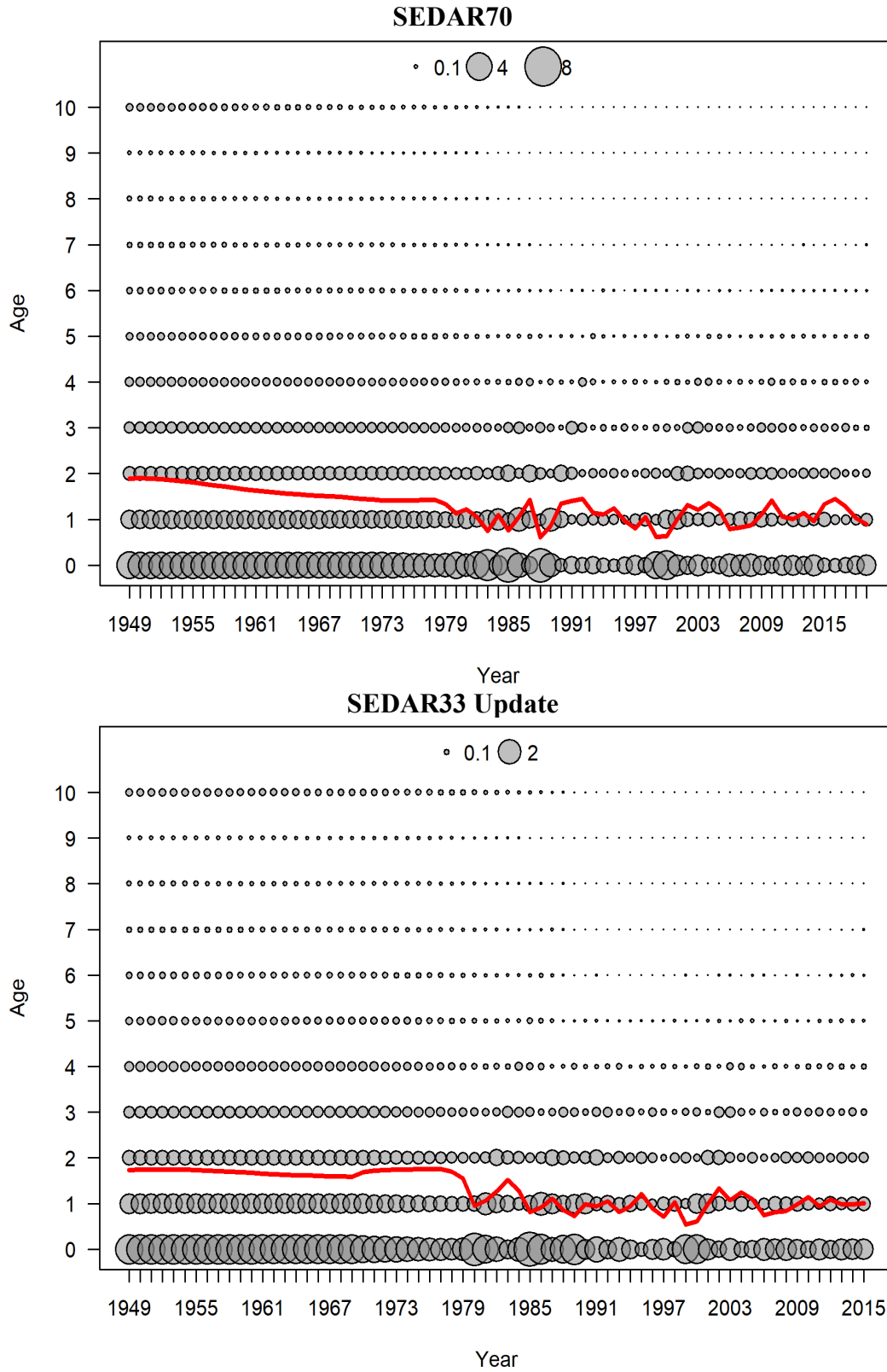

Figure 41. Predicted numbers at age (bubbles) and mean age of Gulf of Mexico Greater Amberjack (red line).

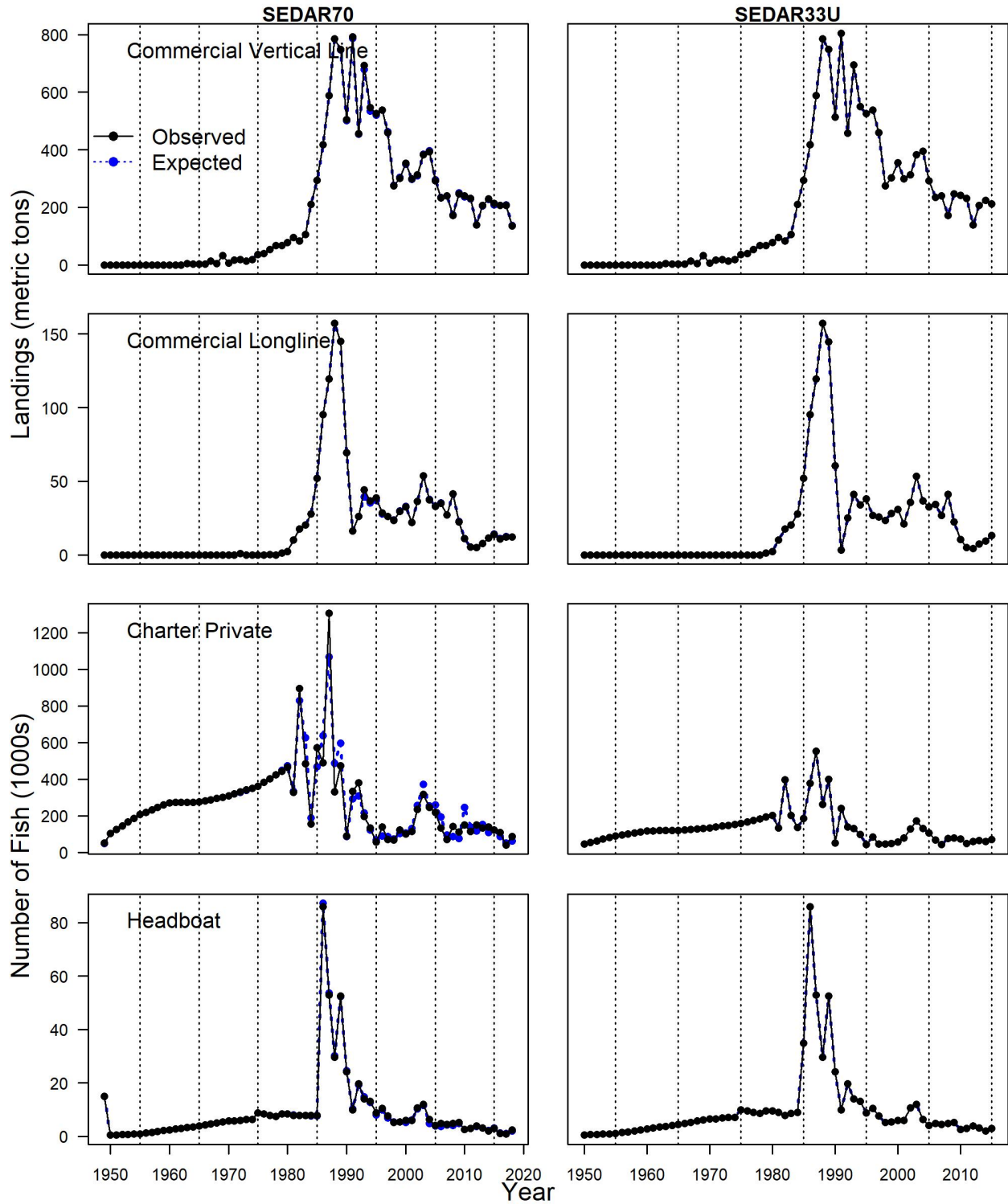

Figure 42. Gulf of Mexico Greater Amberjack observed and expected landings by fishery for SEDAR70 (left panels) and SEDAR33 Update (right panels). Commercial and recreational landings are in metric tons and numbers of fish, respectively. Dashed vertical lines identify ten-year intervals.

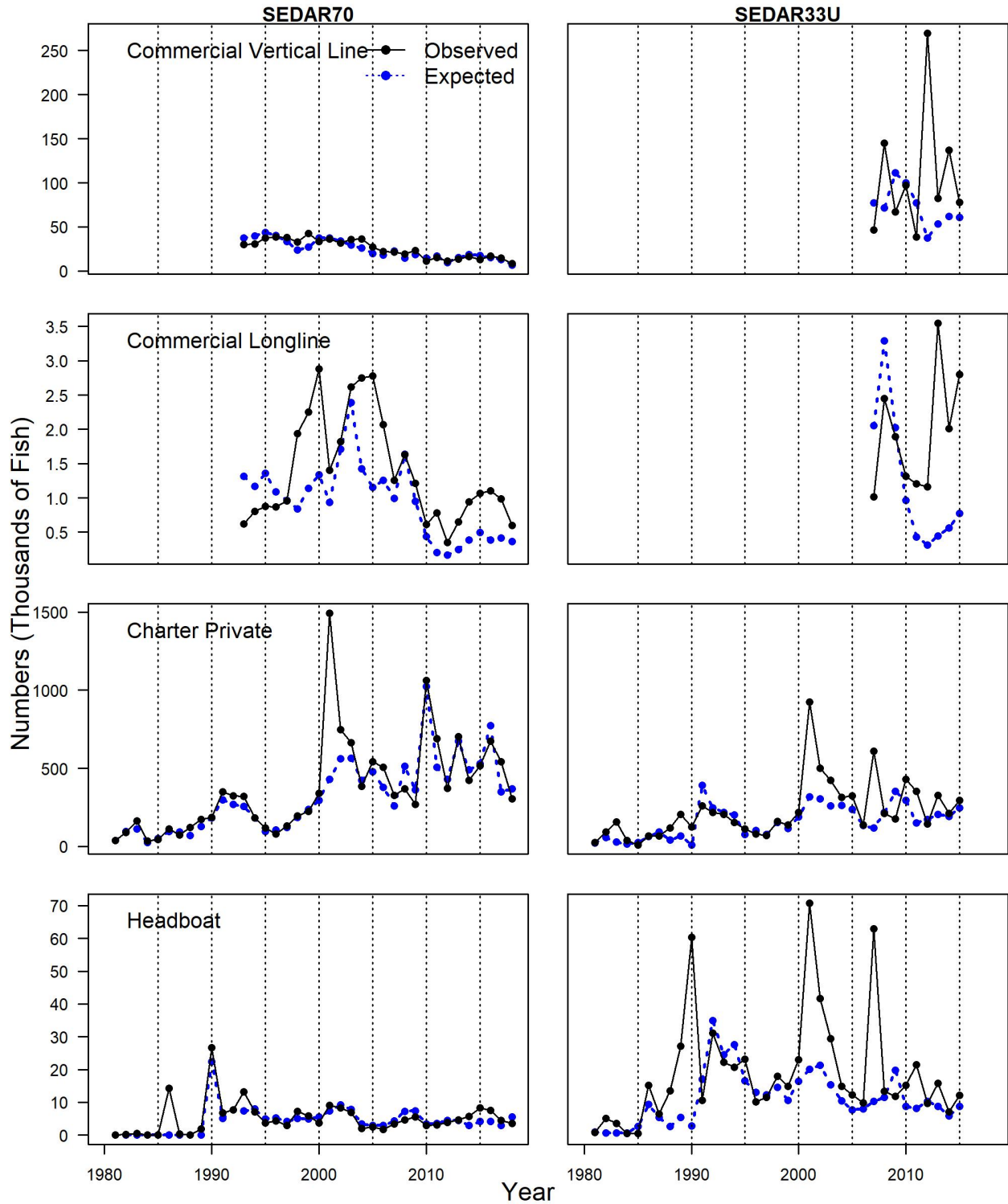

Figure 43. Gulf of Mexico Greater Amberjack observed and expected discards by fishery for SEDAR70 (left panels) and SEDAR33 Update (right panels). Commercial and recreational discards are in numbers of fish, respectively. Dashed vertical lines identify five-year intervals.

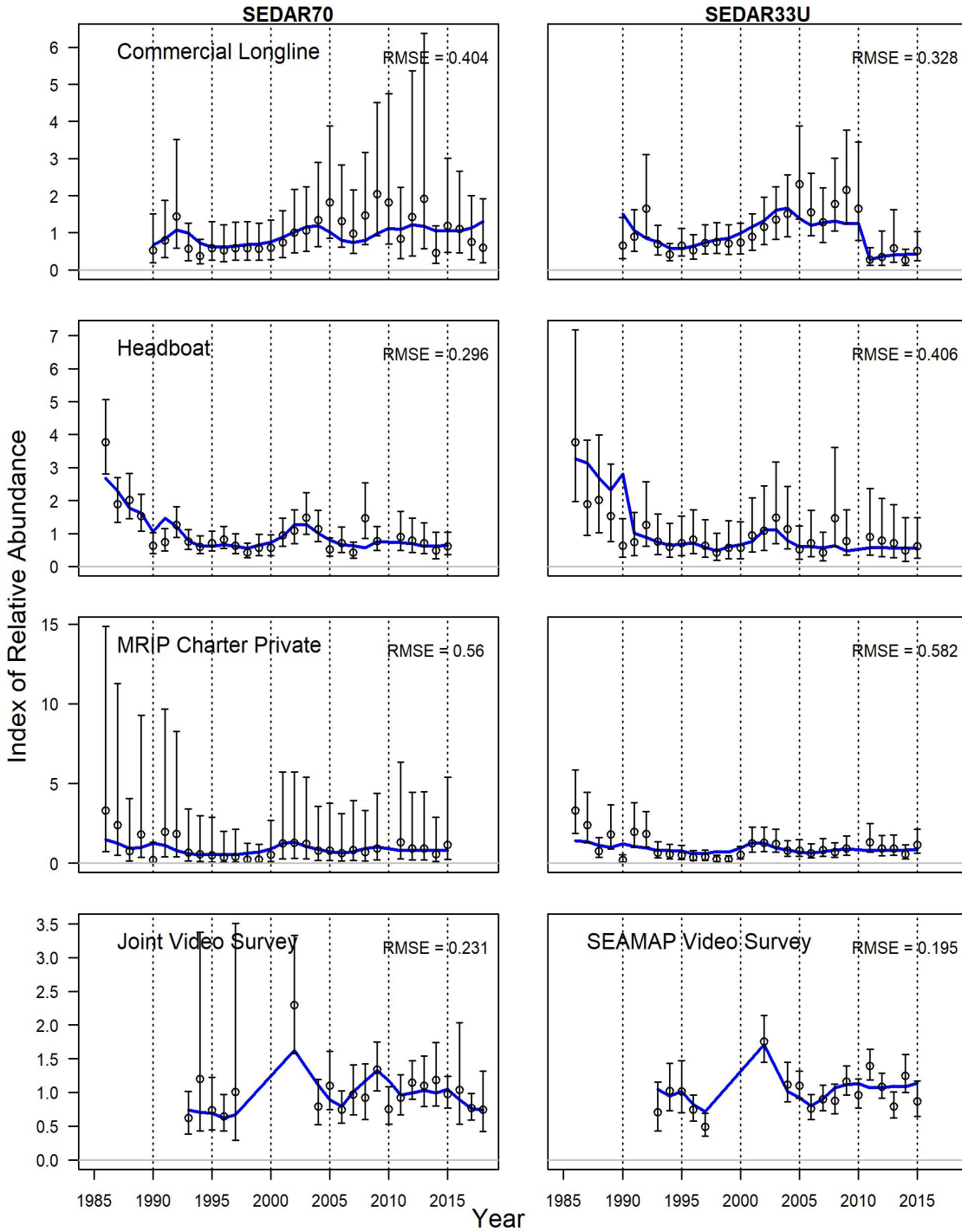

Figure 44. Gulf of Mexico Greater Amberjack observed and expected indices for SEDAR70 (left panels) and SEDAR33 Update (right panels). Dashed vertical lines identify five-year intervals. The root mean squared error (RMSE) is also provided.

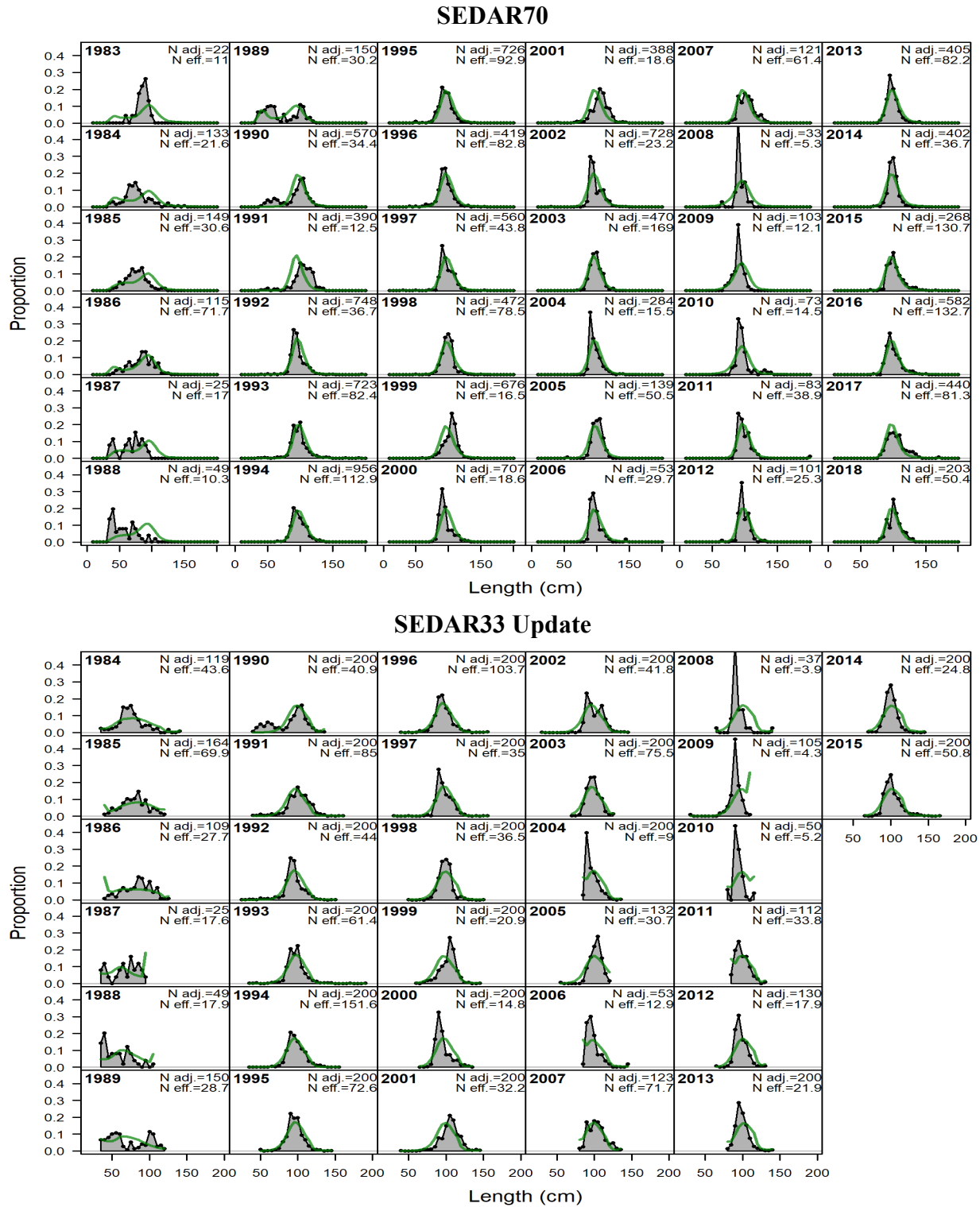

Figure 45. Observed and predicted length compositions (retained) for Gulf of Mexico Greater Amberjack in the Commercial Vertical Line fishery. Green lines represent predicted length compositions, while grey shaded regions represent observed length compositions. Input sample sizes (N_{adj}) and effective sample sizes (N_{eff}) estimated by SS are also reported.

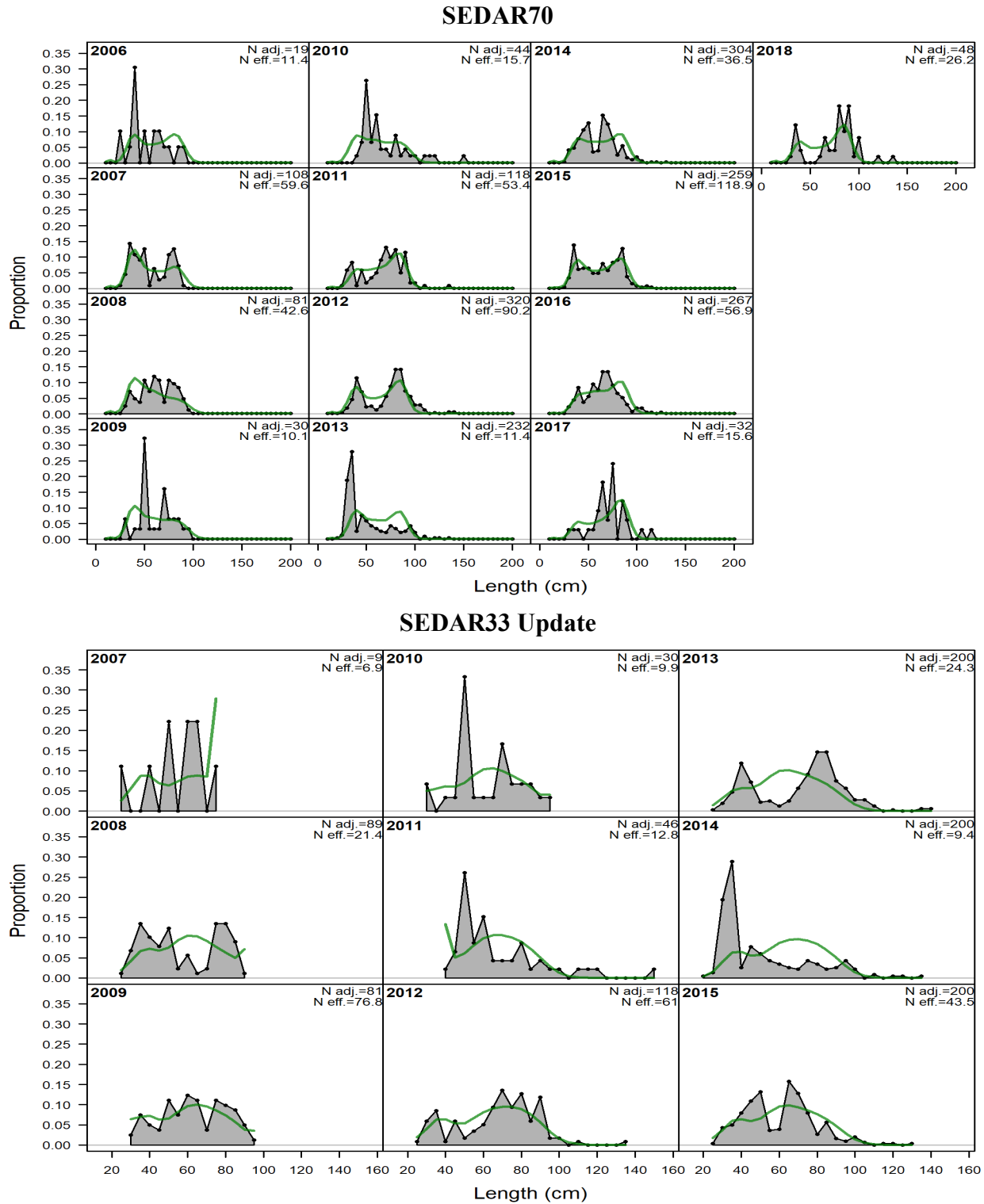

Figure 46. Observed and predicted length compositions (discarded) for Gulf of Mexico Greater Amberjack in the Commercial Vertical Line fishery. Green lines represent predicted length compositions, while grey shaded regions represent observed length compositions. Input sample sizes (N_{adj}) and effective sample sizes (N_{eff}) estimated by SS are also reported.

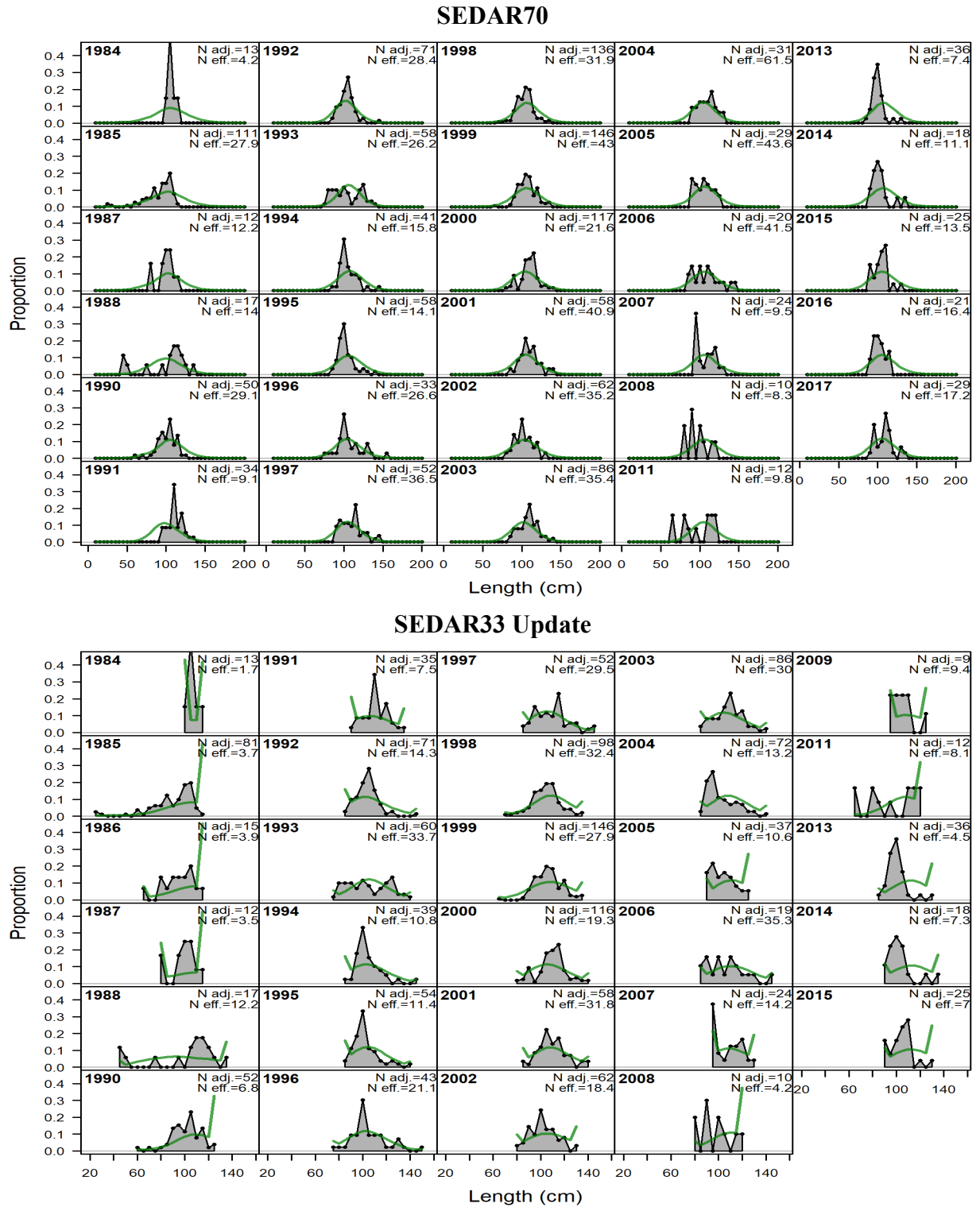

Figure 47. Observed and predicted length compositions (retained) for Gulf of Mexico Greater Amberjack in the Commercial Longline fishery. Green lines represent predicted length compositions, while grey shaded regions represent observed length compositions. Input sample sizes (N adj) and effective sample sizes (N eff) estimated by SS are also reported.

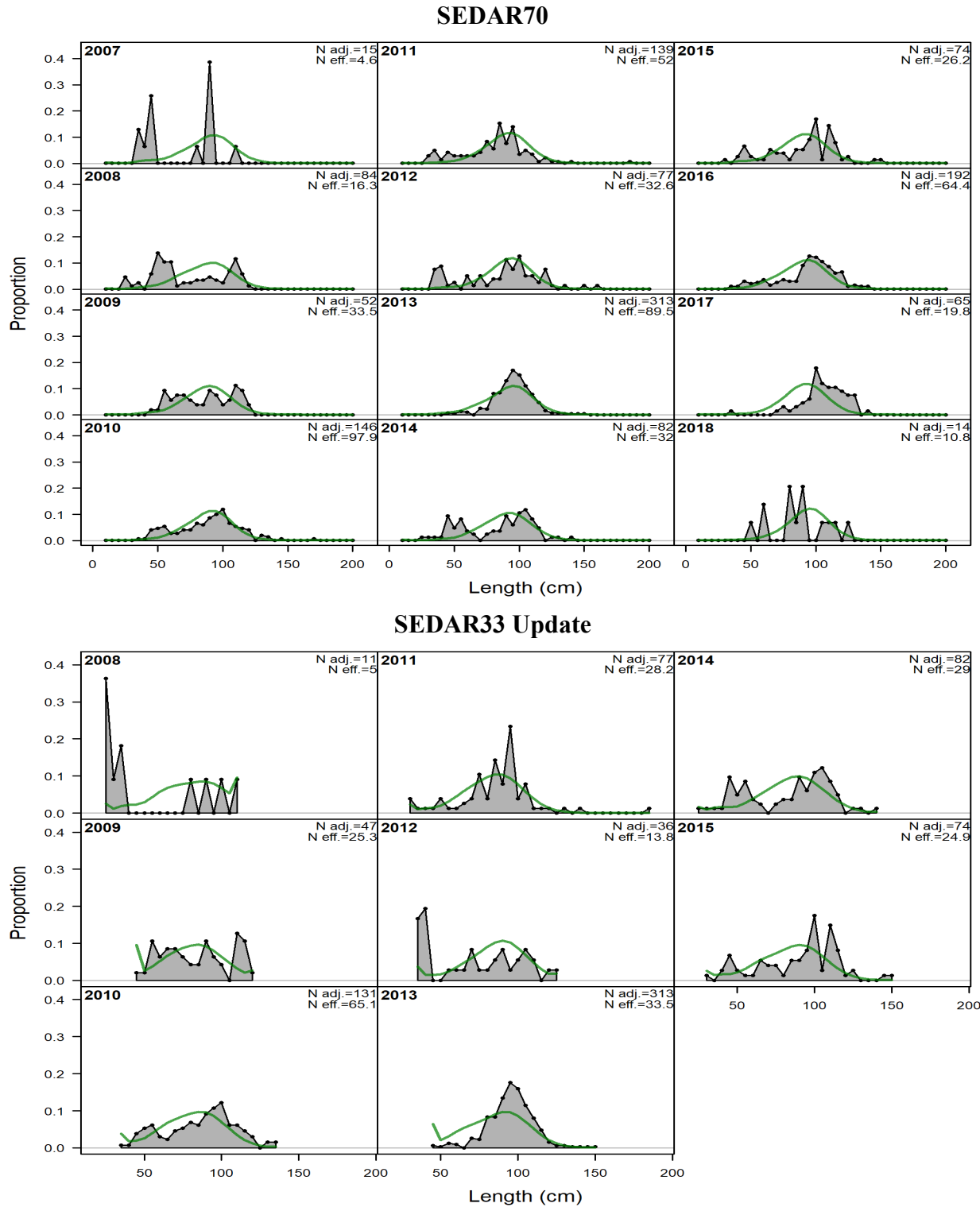

Figure 48. Observed and predicted length compositions (discarded) for Gulf of Mexico Greater Amberjack in the Commercial Longline fishery. Green lines represent predicted length compositions, while grey shaded regions represent observed length compositions. Input sample sizes (N_{adj}) and effective sample sizes (N_{eff}) estimated by SS are also reported.

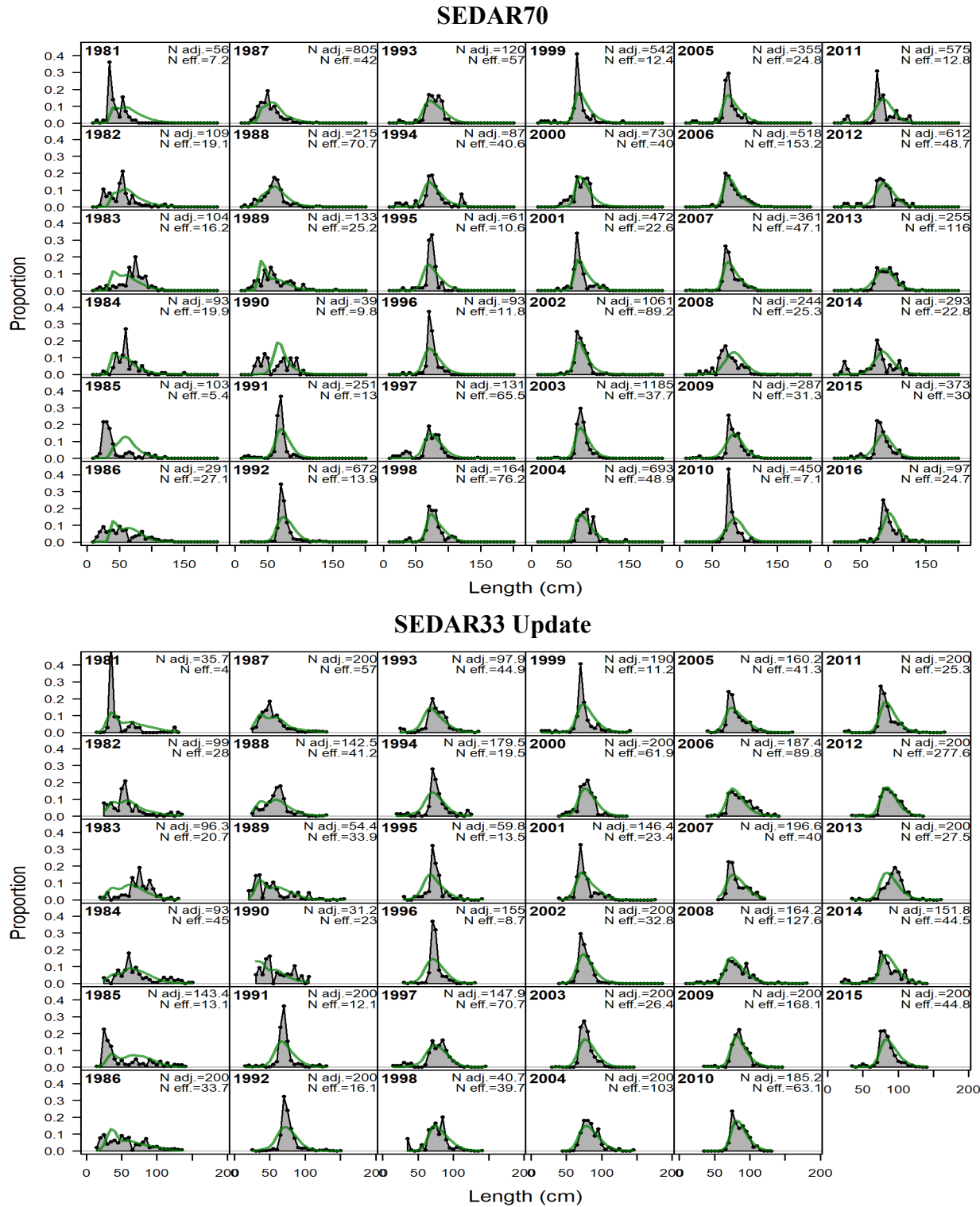

Figure 49. Observed and predicted length compositions (retained) for Gulf of Mexico Greater Amberjack in the Recreational Charter Private fishery. Green lines represent predicted length compositions, while grey shaded regions represent observed length compositions. Input sample sizes (N_{adj}) and effective sample sizes (N_{eff}) estimated by SS are also reported.

SEDAR70

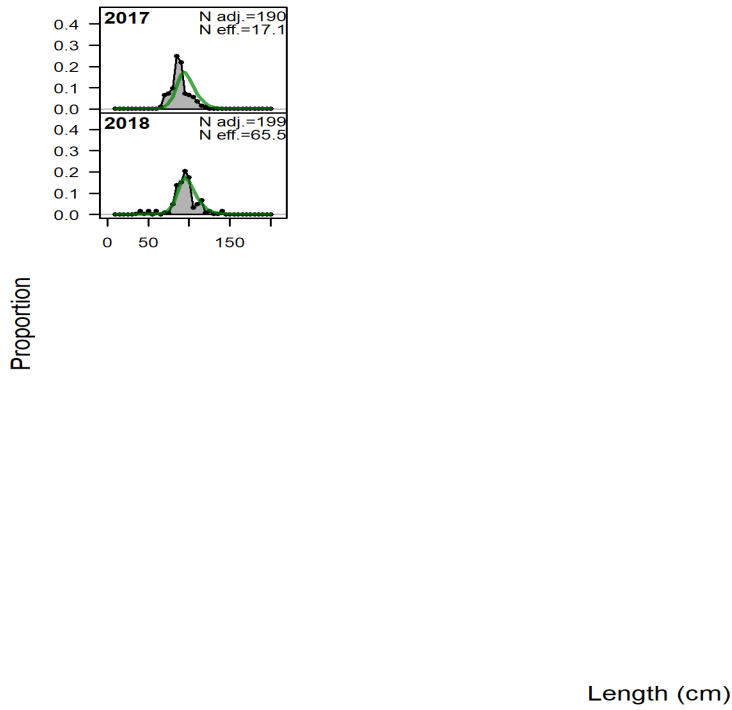

Figure 49 Continued. Observed and predicted length compositions (retained) for Gulf of Mexico Greater Amberjack in the Recreational Charter Private fishery.

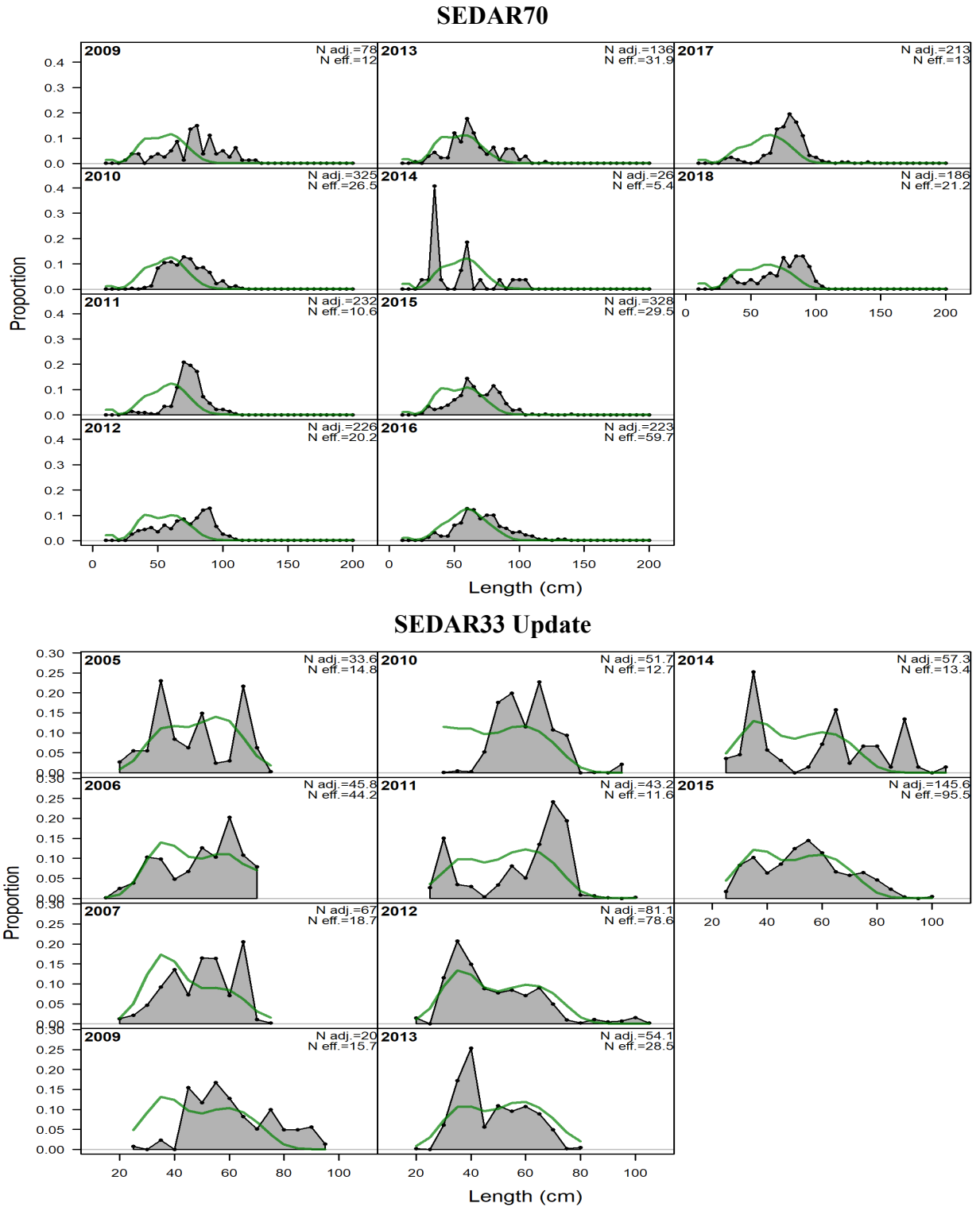

Figure 50. Observed and predicted length compositions (discarded) for Gulf of Mexico Greater Amberjack in the Recreational Charter Private fishery. Green lines represent predicted length compositions, while grey shaded regions represent observed length compositions. Input sample sizes (N_{adj}) and effective sample sizes (N_{eff}) estimated by SS are also reported.

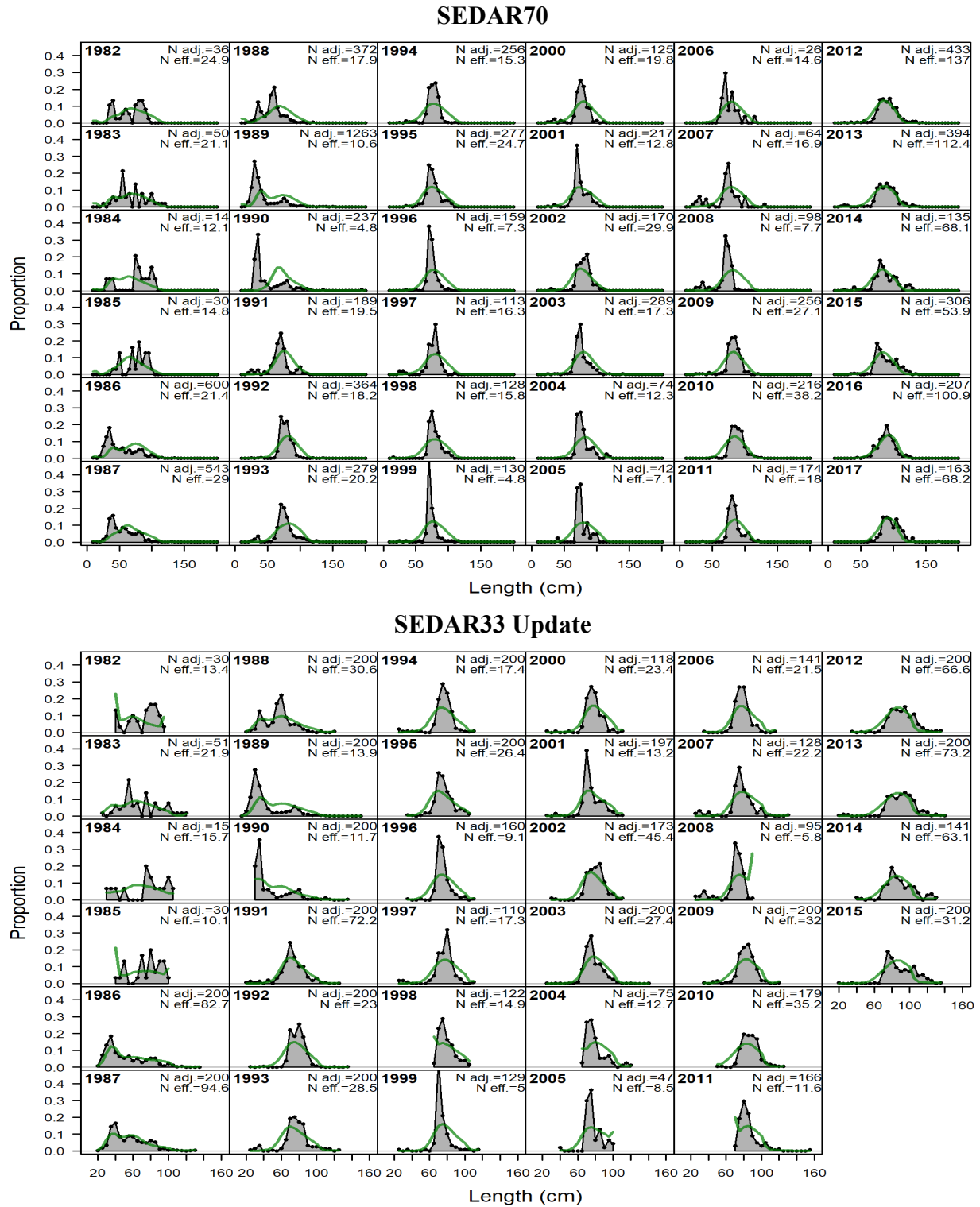

Figure 51. Observed and predicted length compositions (retained) for Gulf of Mexico Greater Amberjack in the Recreational Headboat fishery. Green lines represent predicted length compositions, while grey shaded regions represent observed length compositions. Input sample sizes (N_{adj}) and effective sample sizes (N_{eff}) estimated by SS are also reported.

SEDAR70

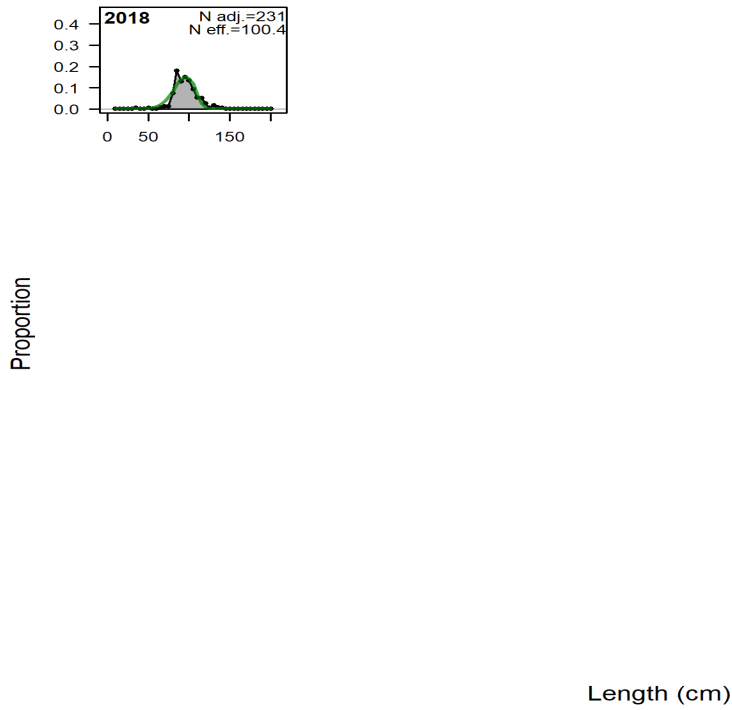

Figure 51 Continued. Observed and predicted length compositions (retained) for Gulf of Mexico Greater Amberjack in the Recreational Headboat fishery.

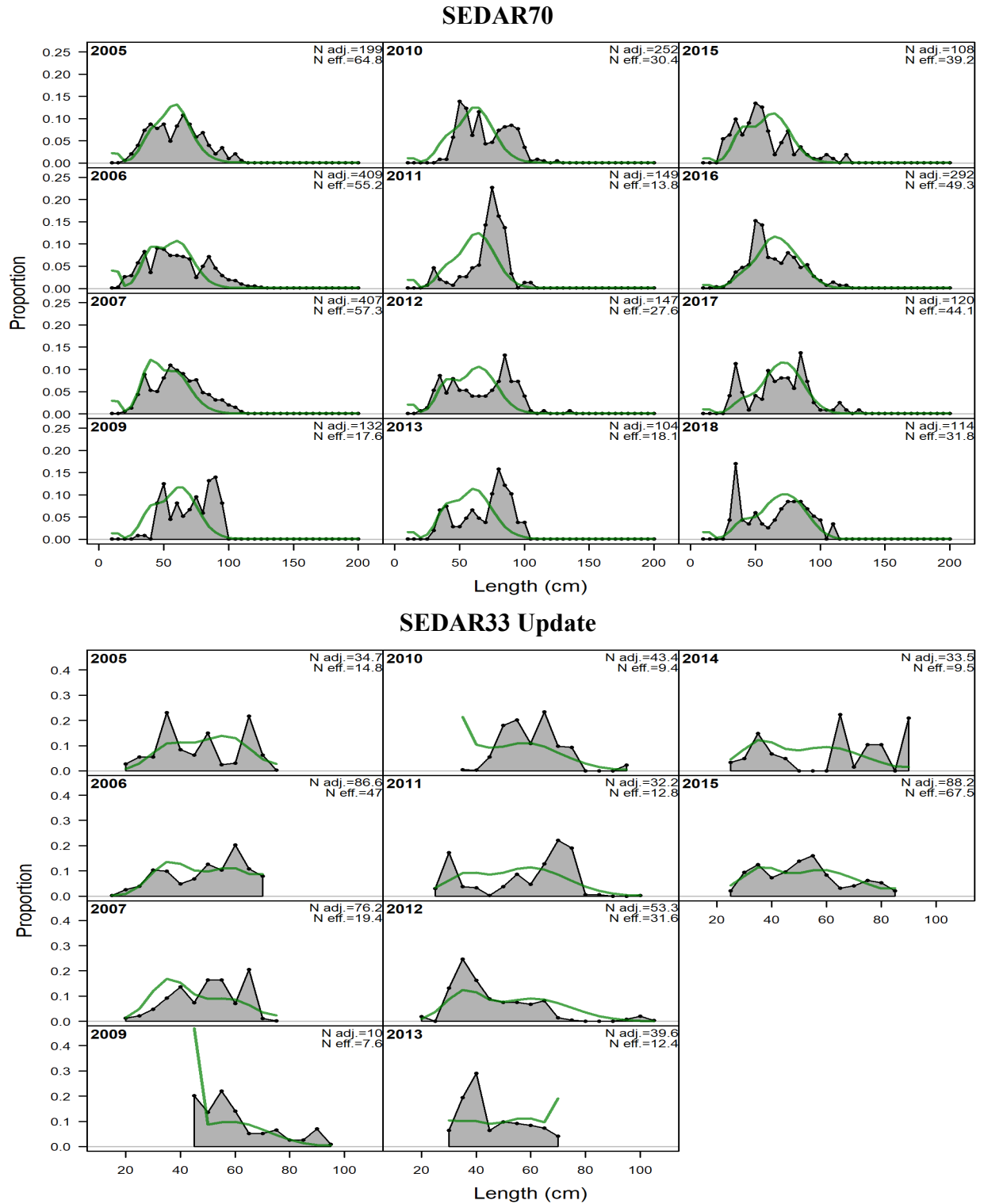

Figure 52. Observed and predicted length compositions (discarded) for Gulf of Mexico Greater Amberjack in the Recreational Headboat fishery. Green lines represent predicted length compositions, while grey shaded regions represent observed length compositions. Input sample sizes (N_{adj}) and effective sample sizes (N_{eff}) estimated by SS are also reported.

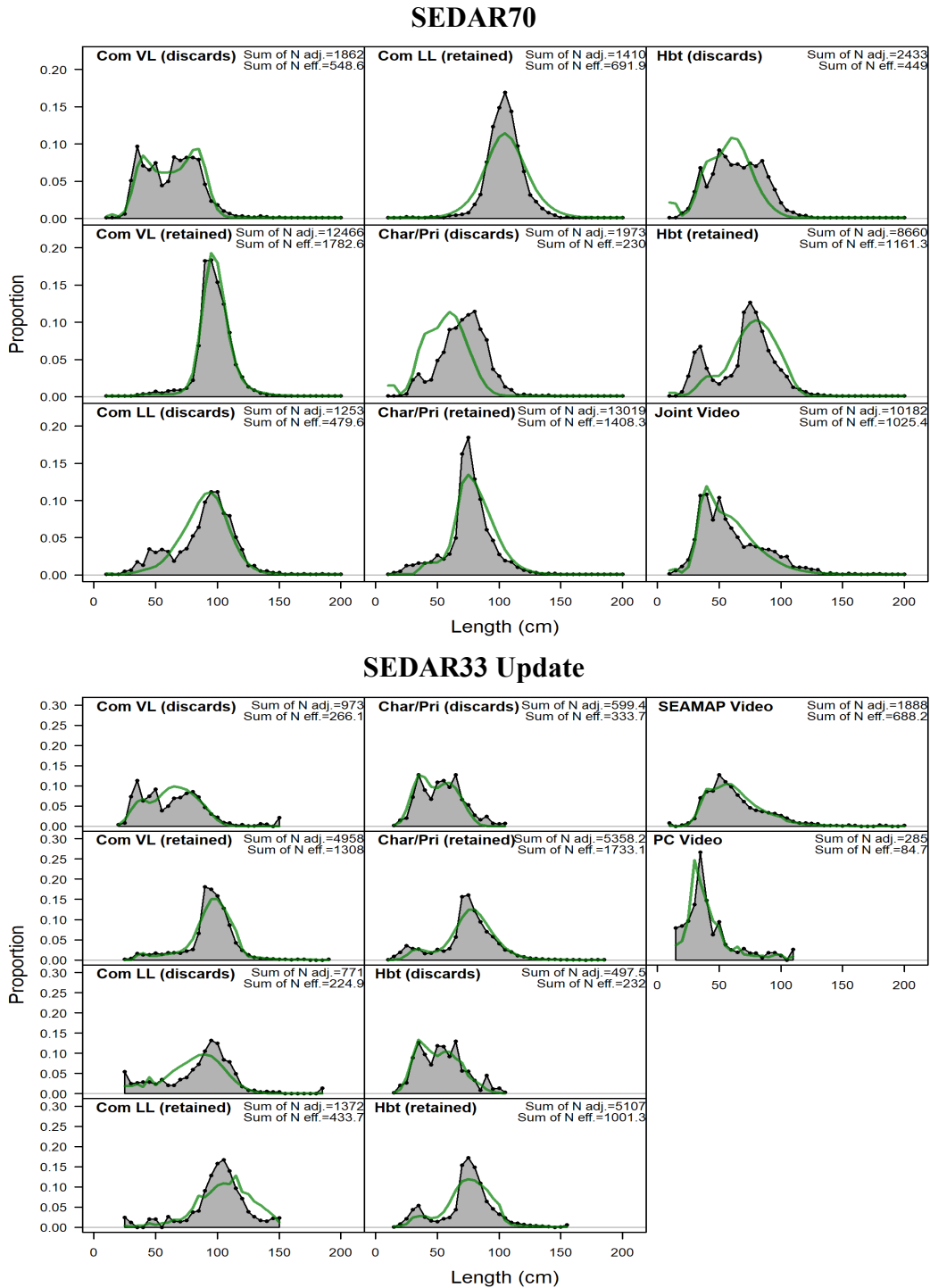

Figure 53. Model fits to the length composition of discarded or retained catch aggregated across years within a given fleet for Gulf of Mexico Greater Amberjack. Green lines represent predicted length compositions, while grey shaded regions represent observed length compositions. The effective sample size used to weight the yearly length composition data is provided by N_{adj} for SEDAR70 (Upper Panel) and N_{eff} for SEDAR33 Update (Lower Panel) and shown in the upper right corner of each panel.

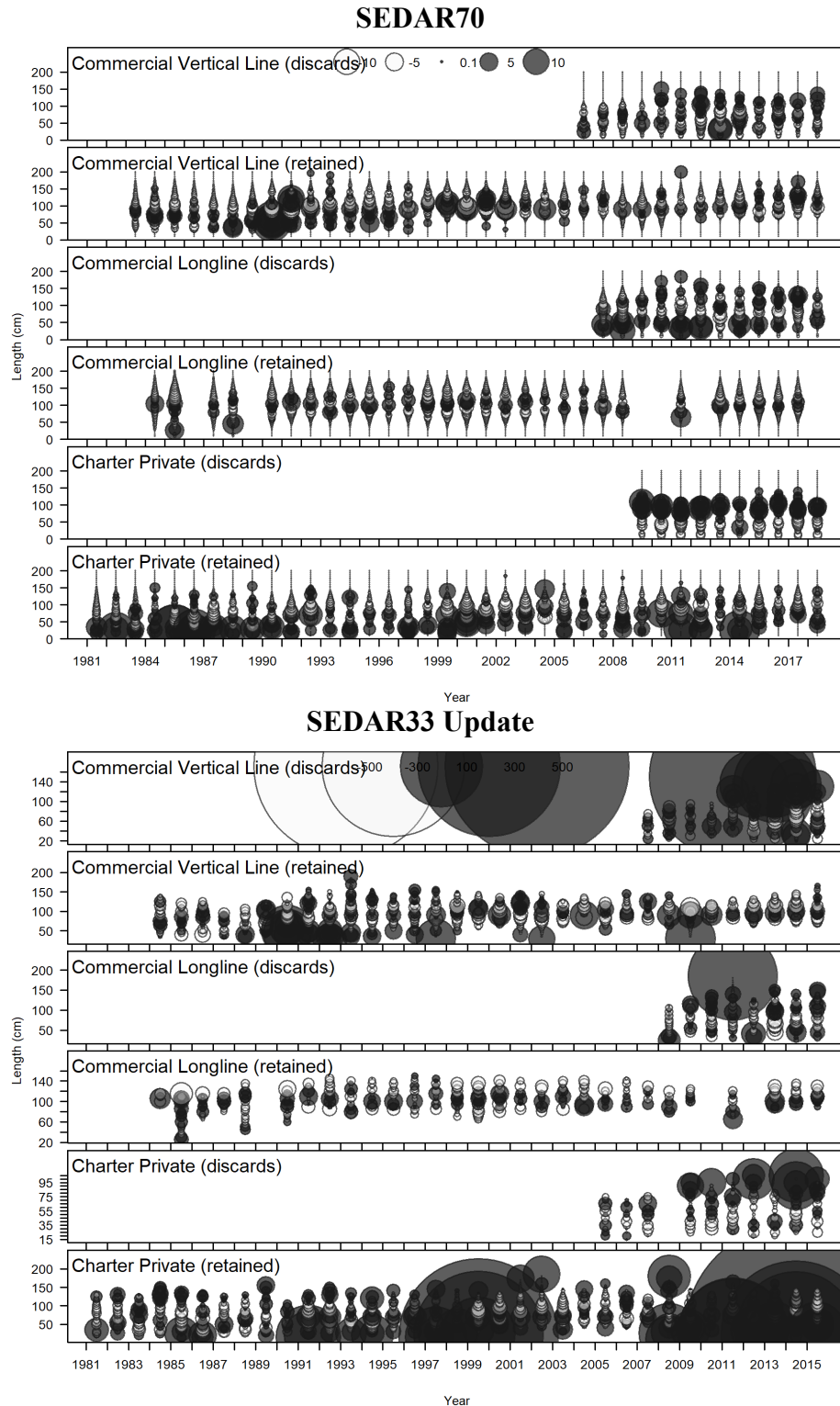

Figure 54. Pearson residuals for discard and retained length composition data by year compared across fleets for Gulf of Mexico Greater Amberjack for SEDAR70 (Upper panel) and SEDAR33 Update (Lower Panel). Closed bubbles are positive residuals (observed > expected) and open bubbles are negative residuals (observed < expected).

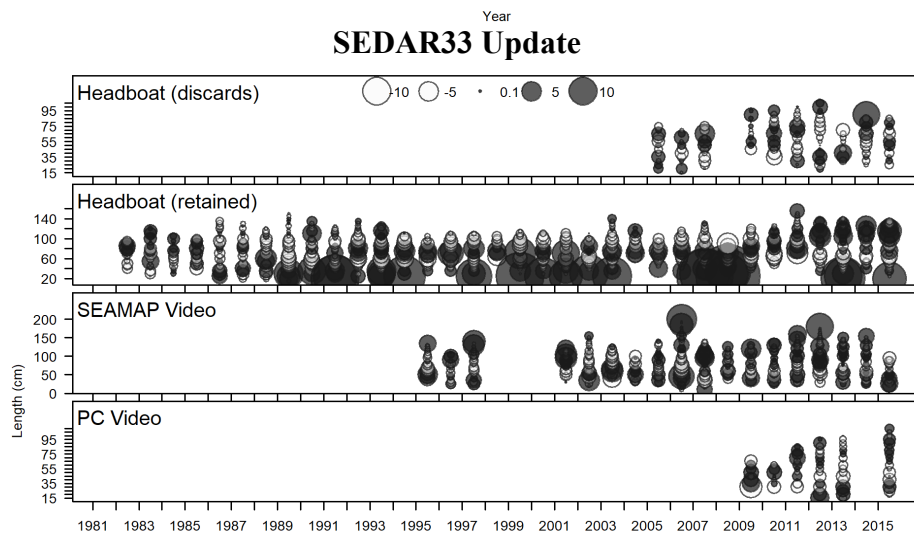
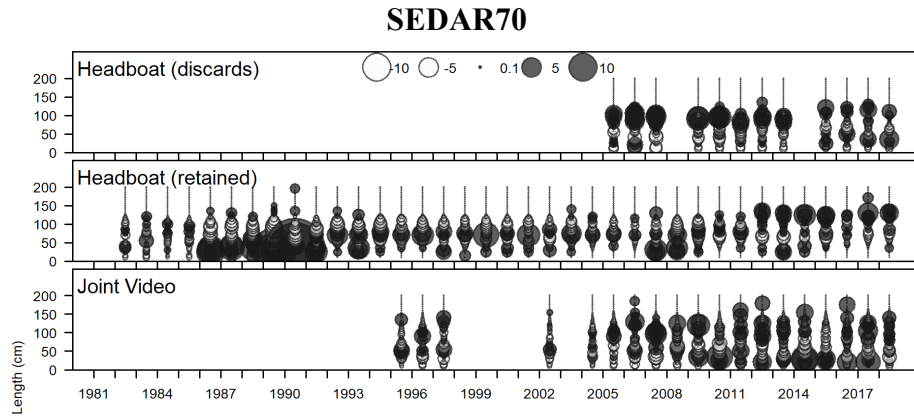

Figure 54 Continued. Pearson residuals for discard and retained length composition data by year compared across fleets for Gulf of Mexico Greater Amberjack for SEDAR70 (Upper panel) and SEDAR33 Update (Lower Panel).

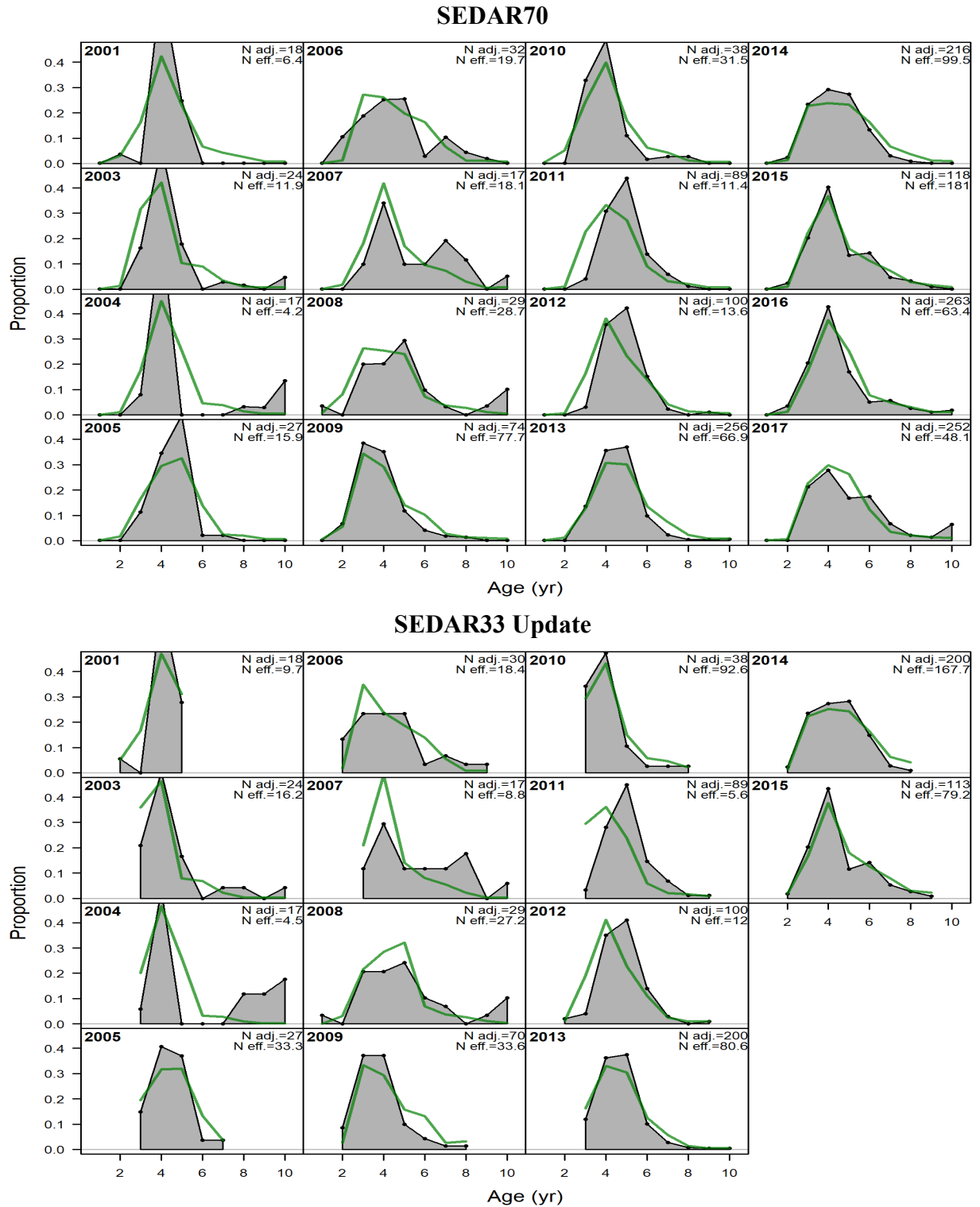

Figure 55. Observed and predicted age compositions (retained) for Gulf of Mexico Greater Amberjack in the Commercial Vertical Line fishery. Green lines represent predicted length compositions, while grey shaded regions represent observed length compositions. Input sample sizes (N_{adj}) and effective sample sizes (N_{eff}) estimated by SS are also reported.

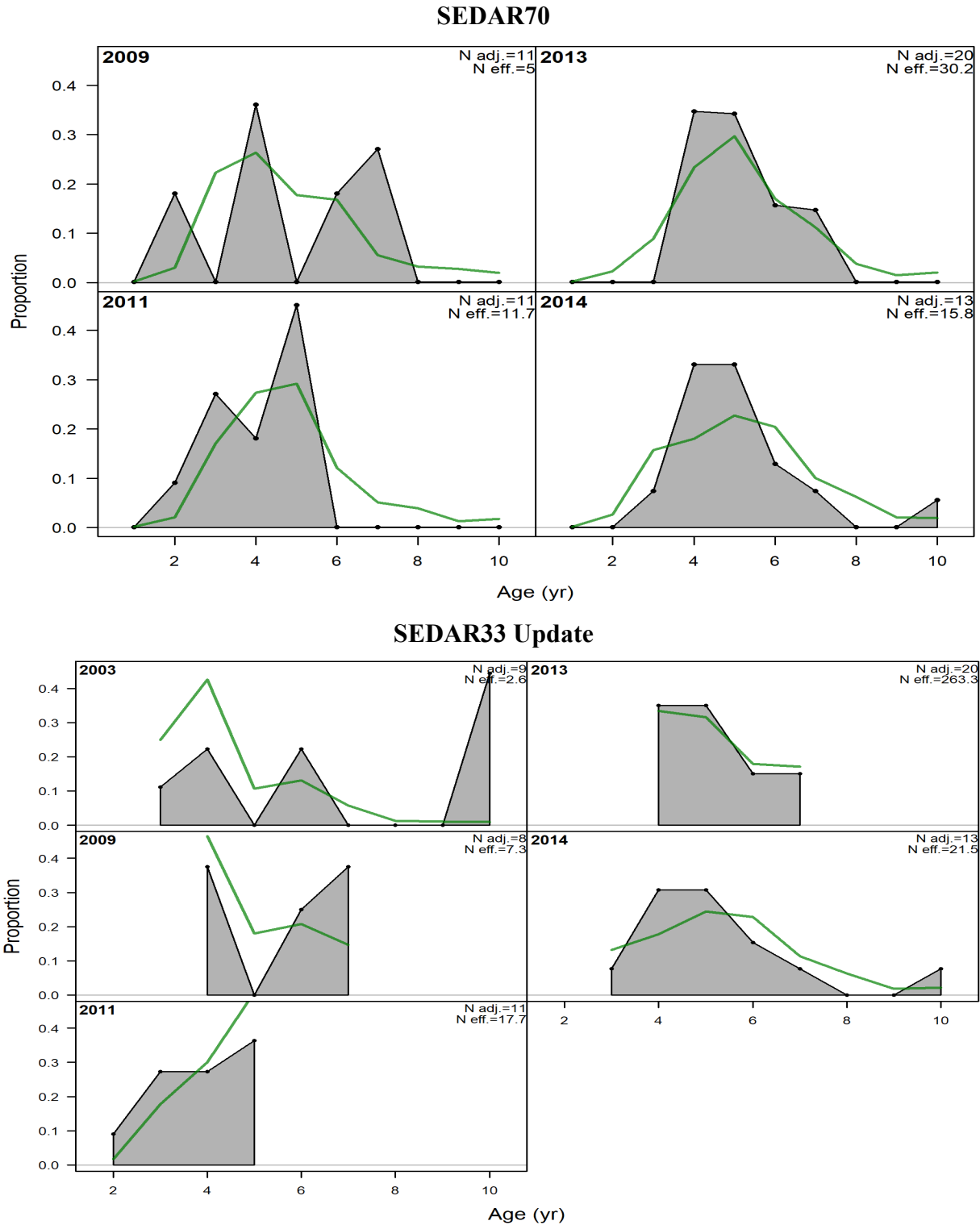

Figure 56. Observed and predicted age compositions (retained) for Gulf of Mexico Greater Amberjack in the Commercial Longline fishery. Green lines represent predicted length compositions, while grey shaded regions represent observed length compositions. Input sample sizes (N_{adj}) and effective sample sizes (N_{eff}) estimated by SS are also reported.

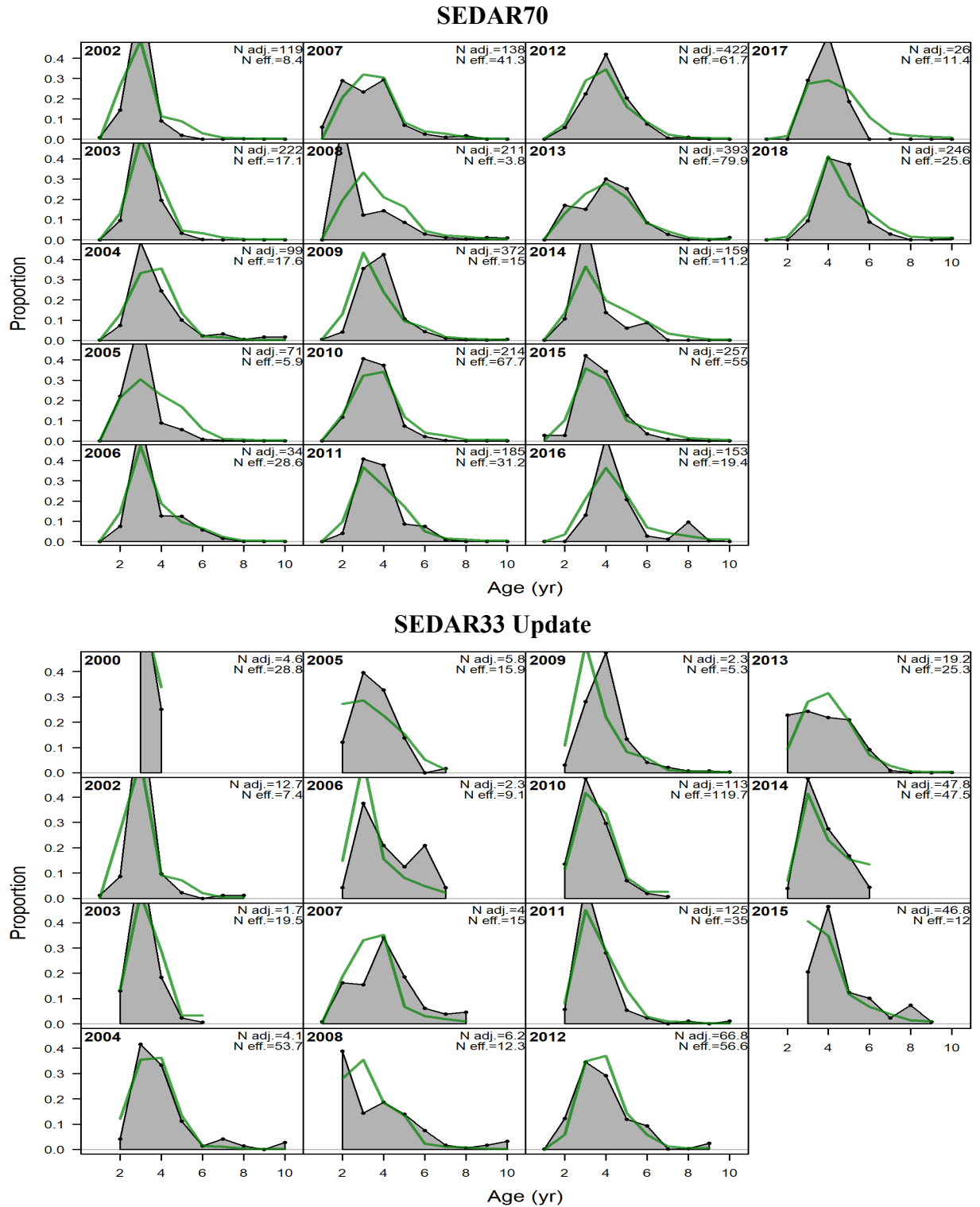

Figure 57. Observed and predicted age compositions (retained) for Gulf of Mexico Greater Amberjack in the Recreational Charter Private fishery. Green lines represent predicted length compositions, while grey shaded regions represent observed length compositions. Input sample sizes (N_{adj}) and effective sample sizes (N_{eff}) estimated by SS are also reported.

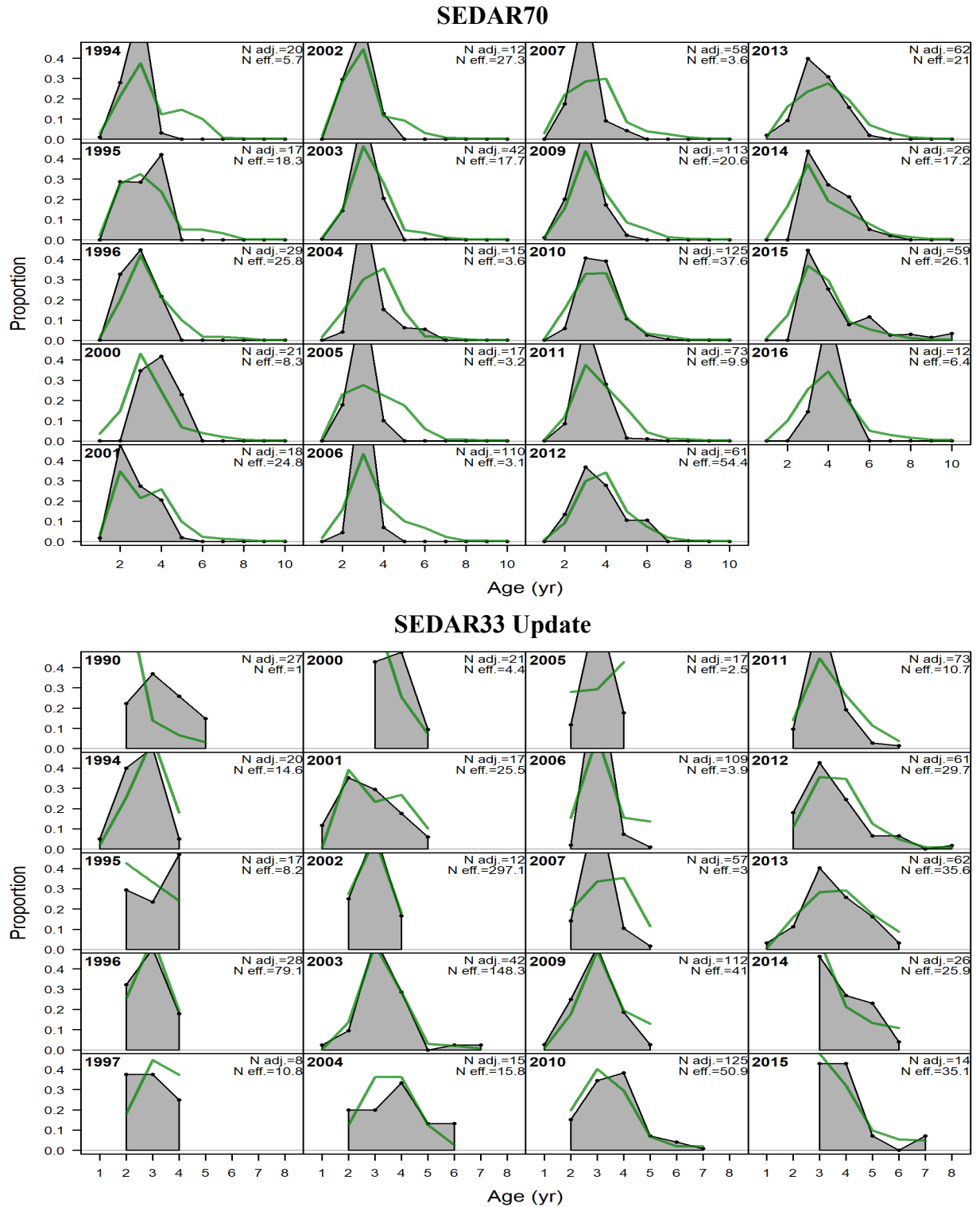
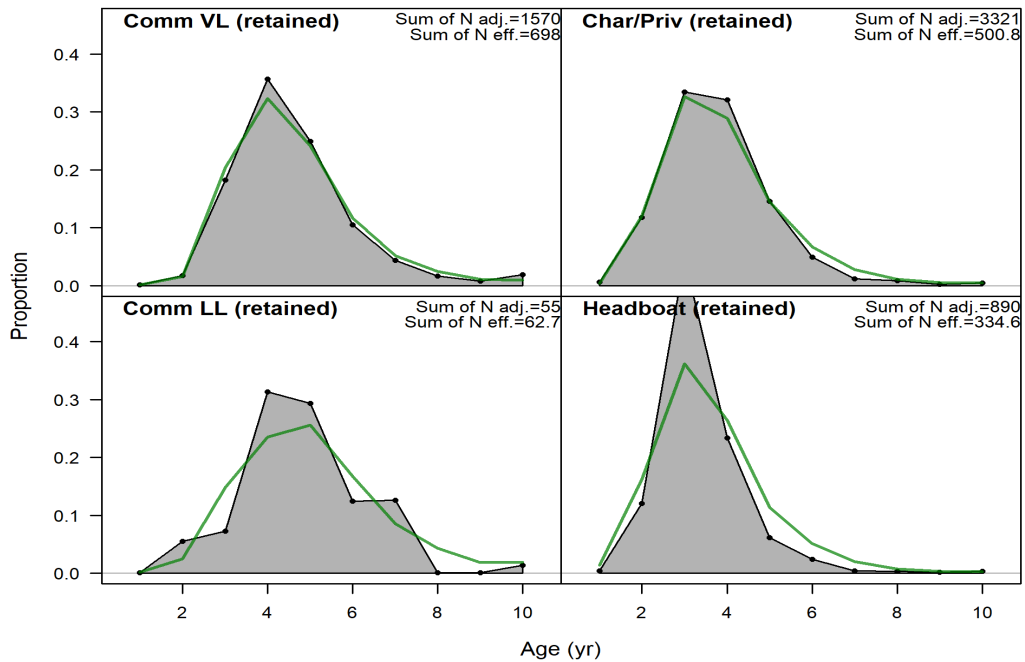

Figure 58. Observed and predicted age compositions (retained) for Gulf of Mexico Greater Amberjack in the Recreational Headboat fishery. Green lines represent predicted length compositions, while grey shaded regions represent observed length compositions. Input sample sizes (N_{adj}) and effective sample sizes (N_{eff}) estimated by SS are also reported.

SEDAR70



SEDAR33 Update

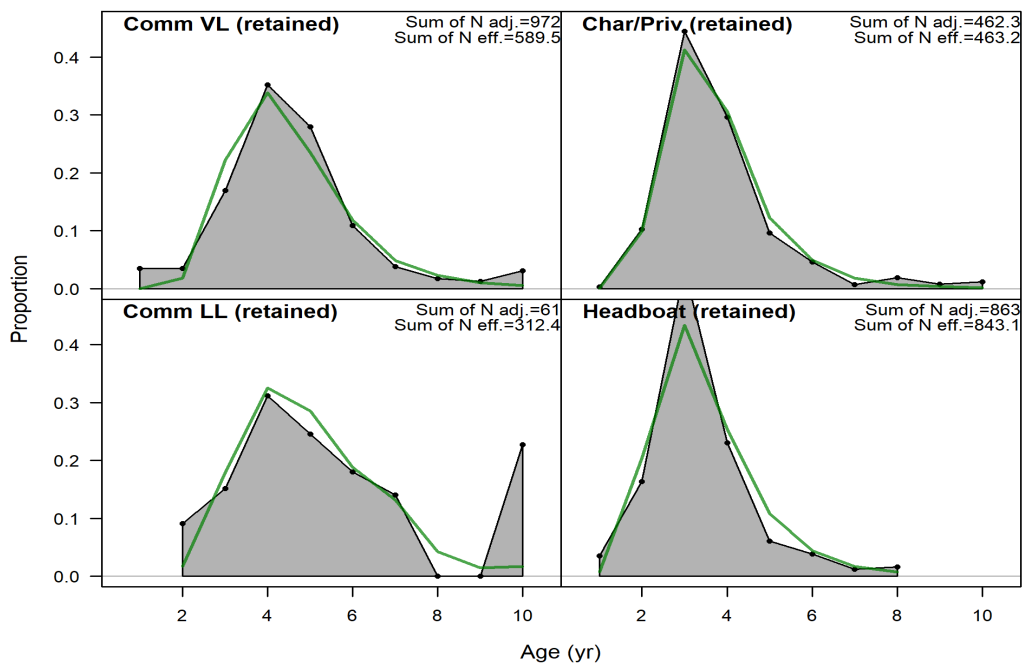

Figure 59. Model fits to the age composition of retained catch aggregated across years within a given fleet for Gulf of Mexico Greater Amberjack. Green lines represent predicted length compositions, while grey shaded regions represent observed length compositions. The effective sample size used to weight the yearly length composition data is provided by N_{adj} for SEDAR70 (Upper Panel) and N_{eff} for SEDAR33 Update (Lower Panel) and shown in the upper right corner of each panel.

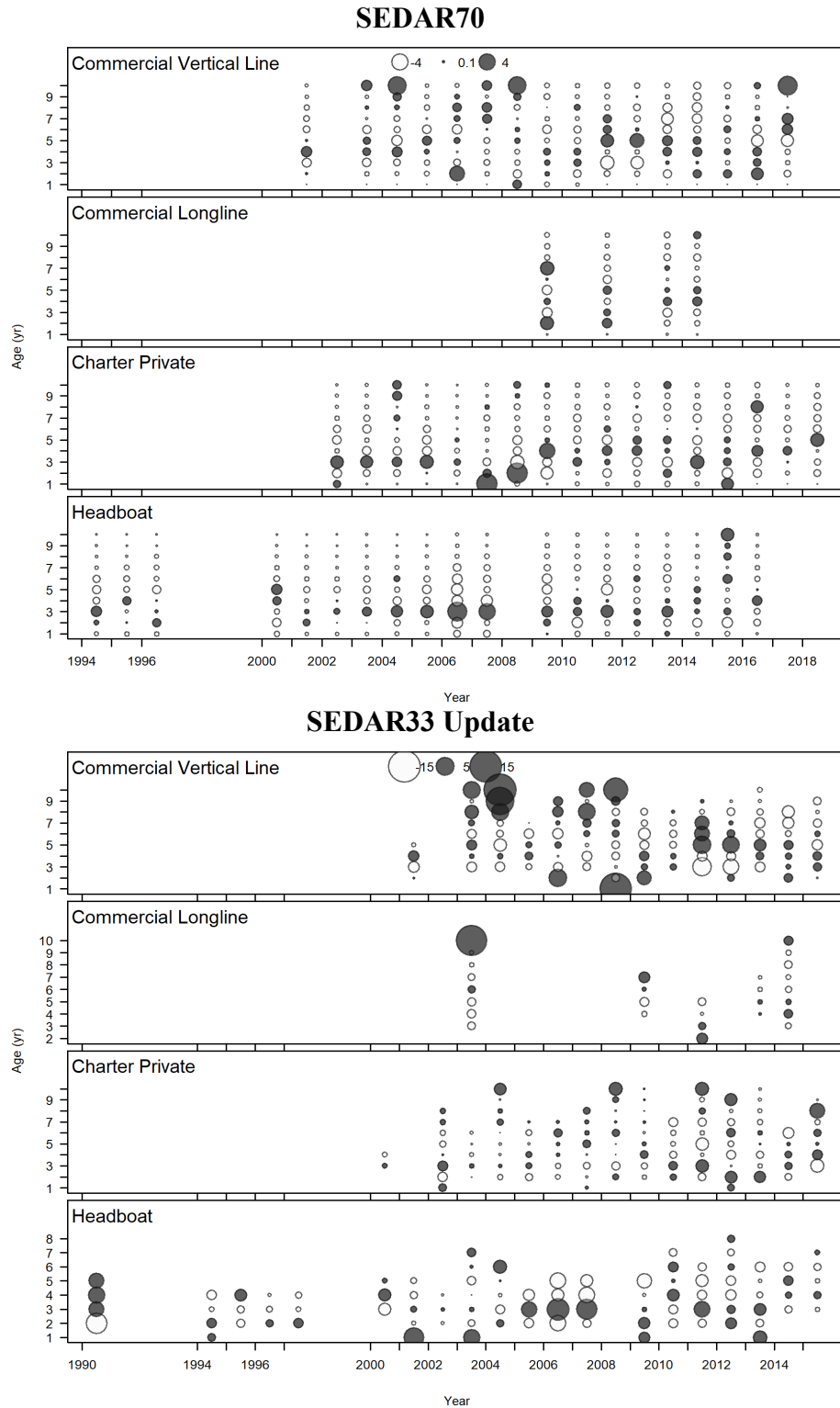

Figure 60. Pearson residuals for retained age composition data by year compared across fleets for Gulf of Mexico Greater Amberjack for SEDAR70 (Upper panel) and SEDAR33 Update (Lower Panel). Closed bubbles are positive residuals (observed > expected) and open bubbles are negative residuals (observed < expected).

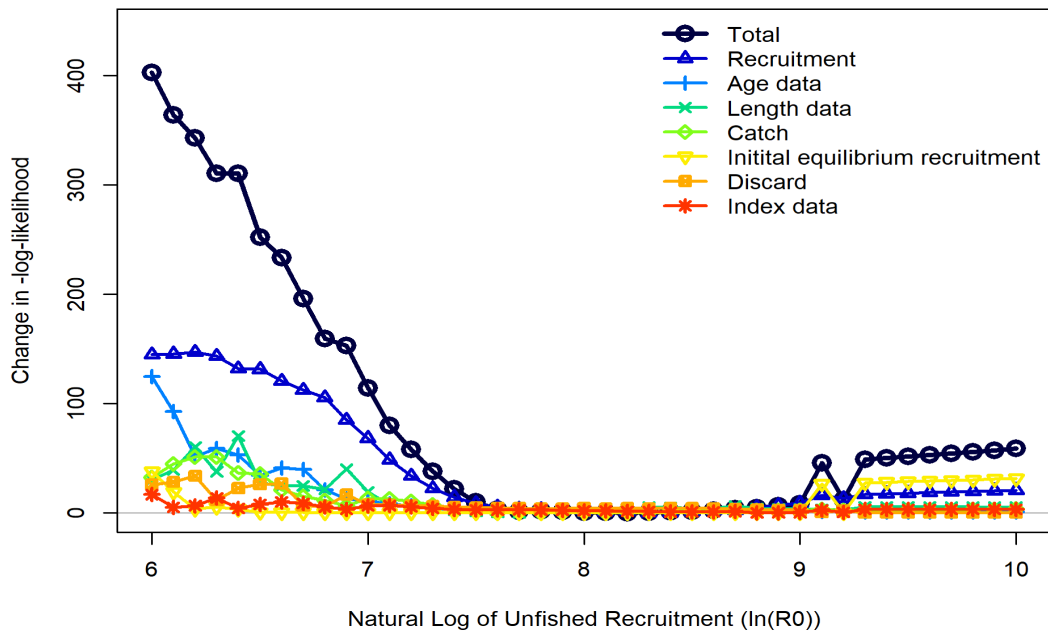

Figure 61. The profile likelihood for the natural log of the unfished recruitment parameter of the Beverton – Holt stock-recruit function for Gulf of Mexico Greater Amberjack. Each line represents the change in negative log-likelihood value for each of the data sources fit in the model across the range of fixed steepness values tested in the profile diagnostic run. The MLE for the base model was 8.215.

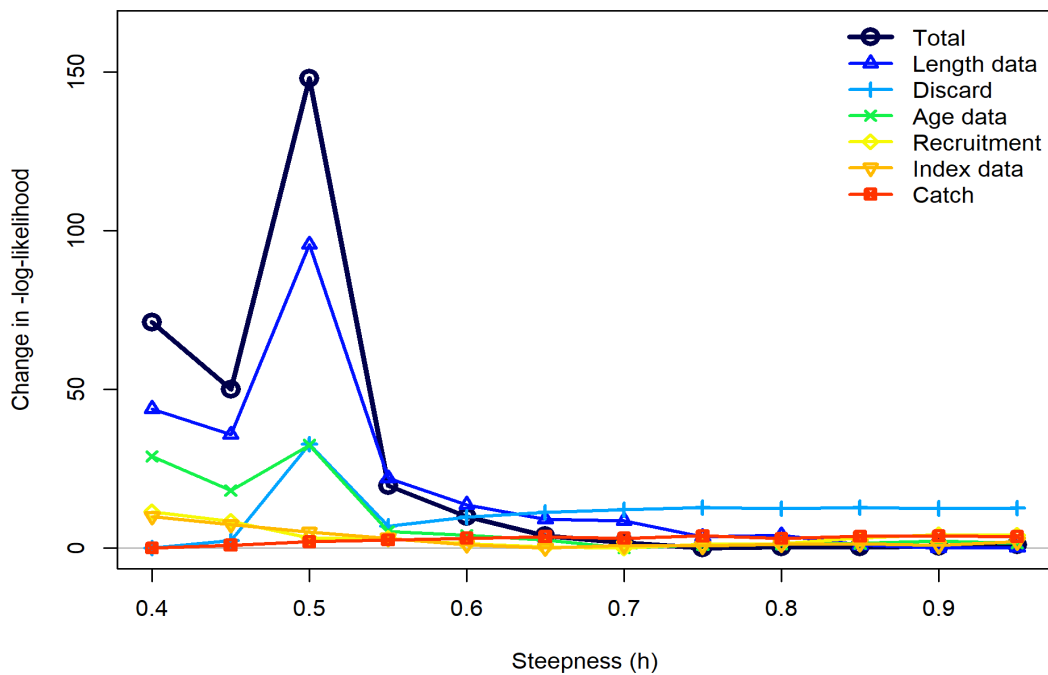

Figure 62. The profile likelihood for the steepness parameter of the Beverton – Holt stock-recruit function for Gulf of Mexico Greater Amberjack. Each line represents the change in negative log-likelihood value for each of the data sources fit in the model across the range of fixed steepness values tested in the profile diagnostic run. The MLE for the base model was 0.777.

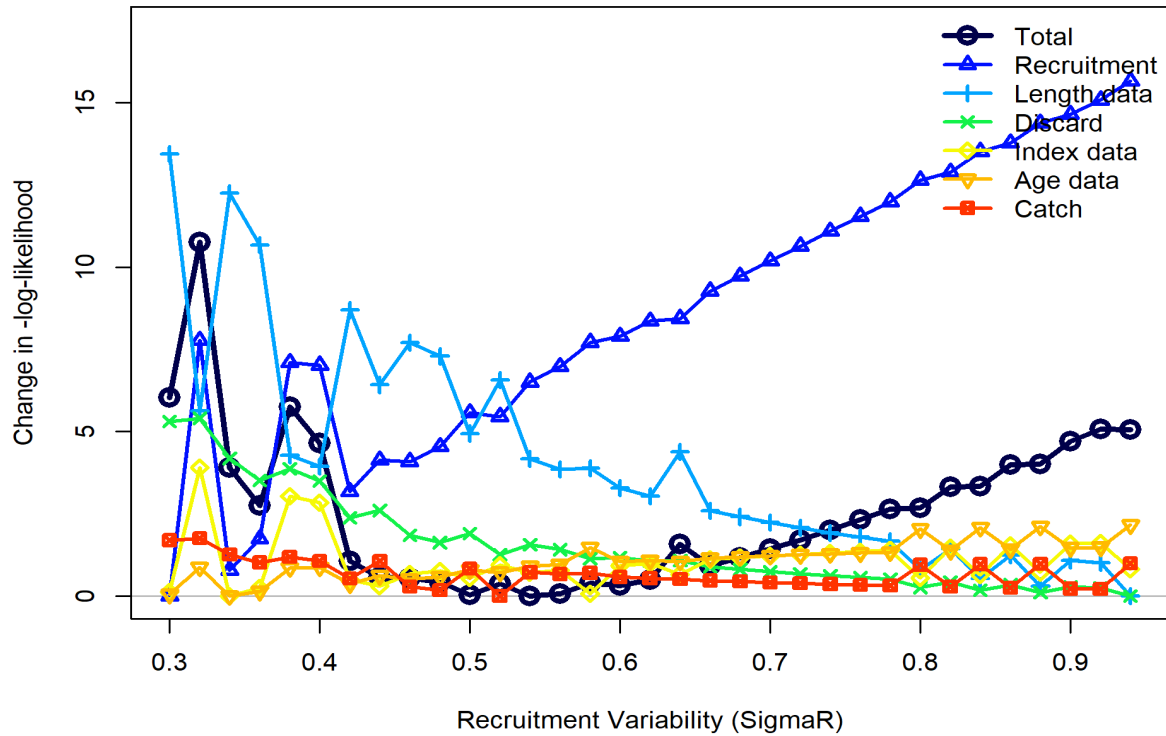

Figure 63. The profile likelihood for the variance parameter of the Beverton – Holt stock-recruit function for Gulf of Mexico Greater Amberjack. Each line represents the change in negative log-likelihood value for each of the data sources fit in the model across the range of fixed steepness values tested in the profile diagnostic run. The MLE for the base model was 0.524.

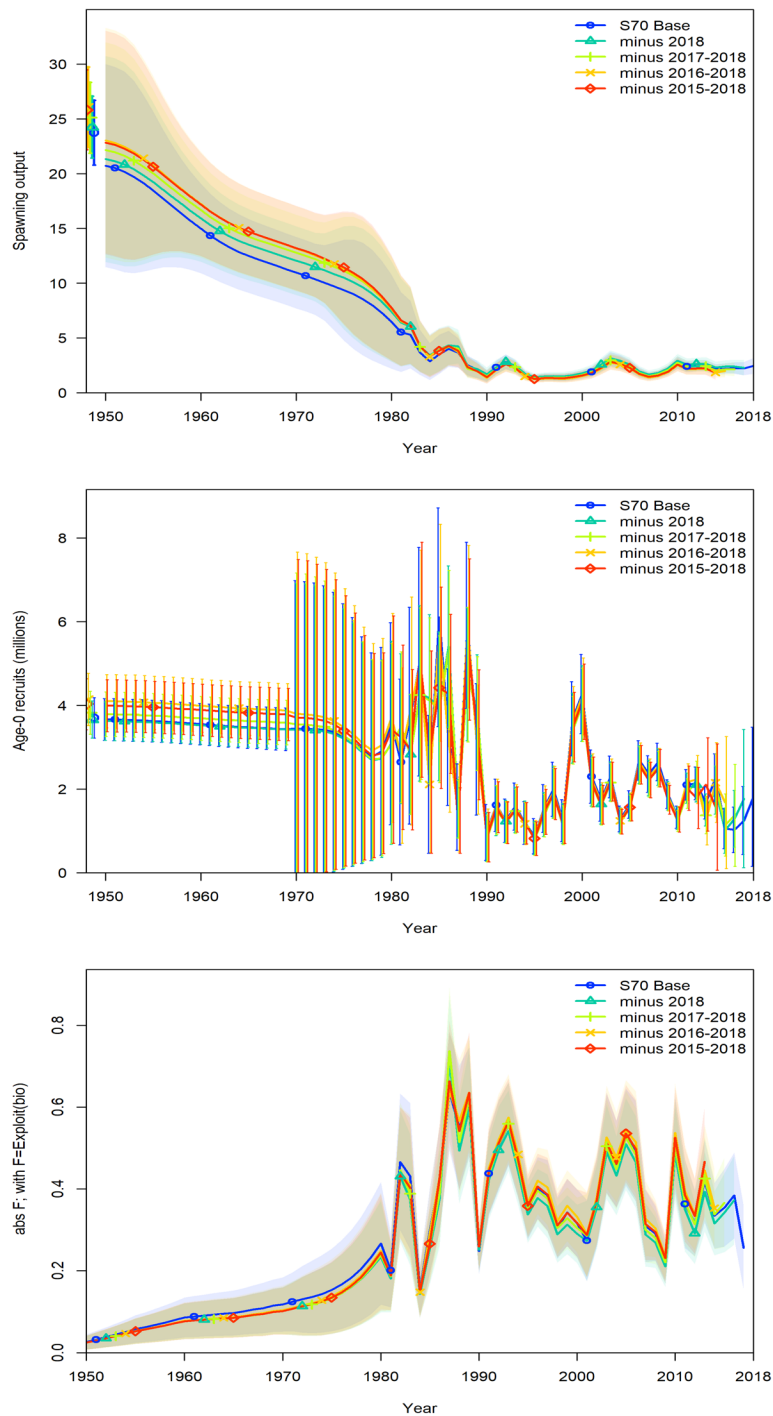

Figure 64. Results of a five-year retrospective analysis for spawning biomass (metric tons; top panel), recruitment (millions of fish; middle panel), and fishing mortality (total biomass killed age 1+ / total biomass age 1+; bottom panel) for the Gulf of Mexico Greater Amberjack Base Model. There is no discernible systematic bias, because each data peel is not consistently over or underestimating any of the population quantities.

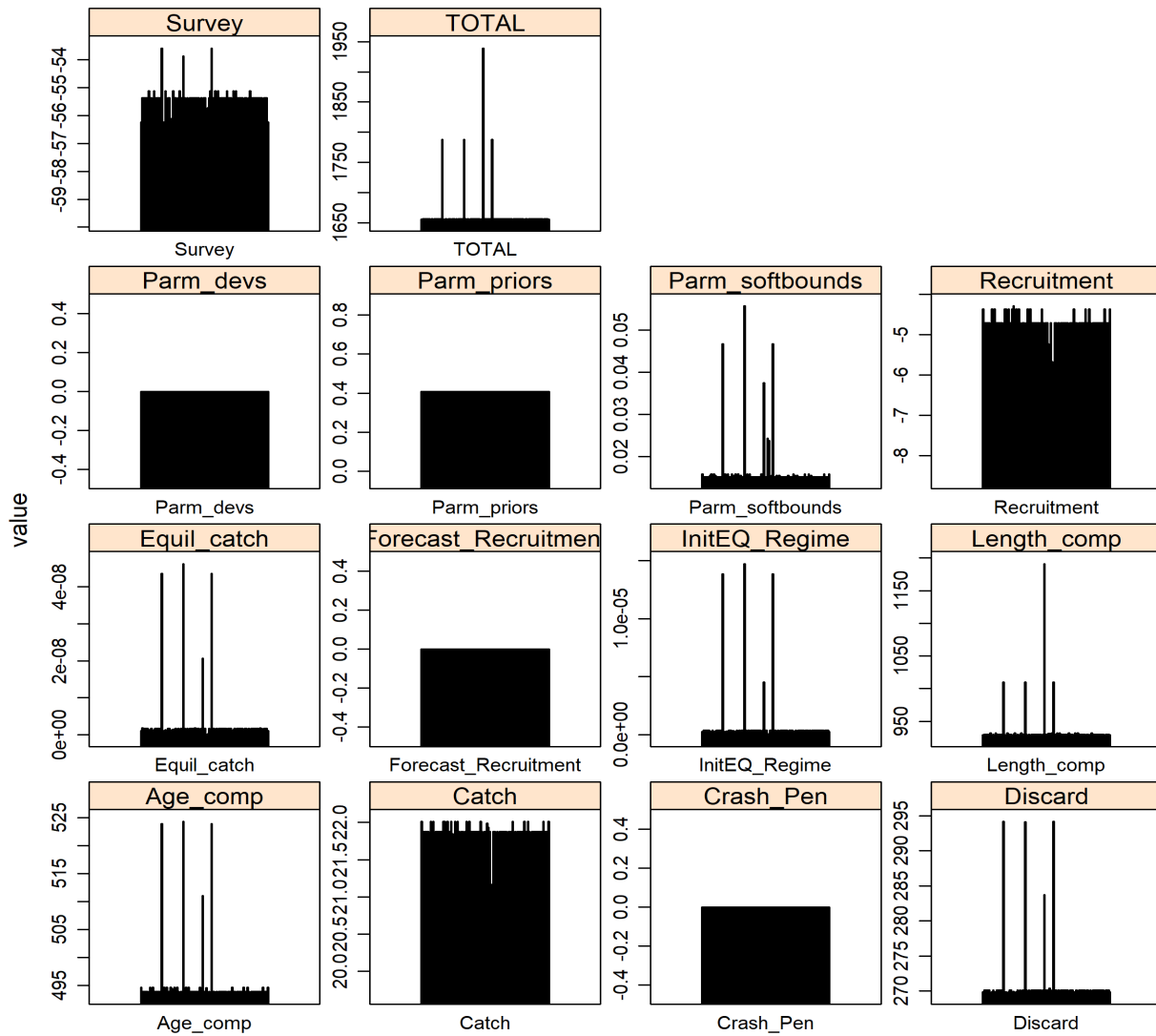

Figure 65. Results of the jitter analysis for various likelihood components for the Gulf of Mexico Greater Amberjack Base Model. Each panel gives the results of 100 model runs where the starting parameter values for each run were randomly changed ('jittered') by 10% from the base model best fit values.

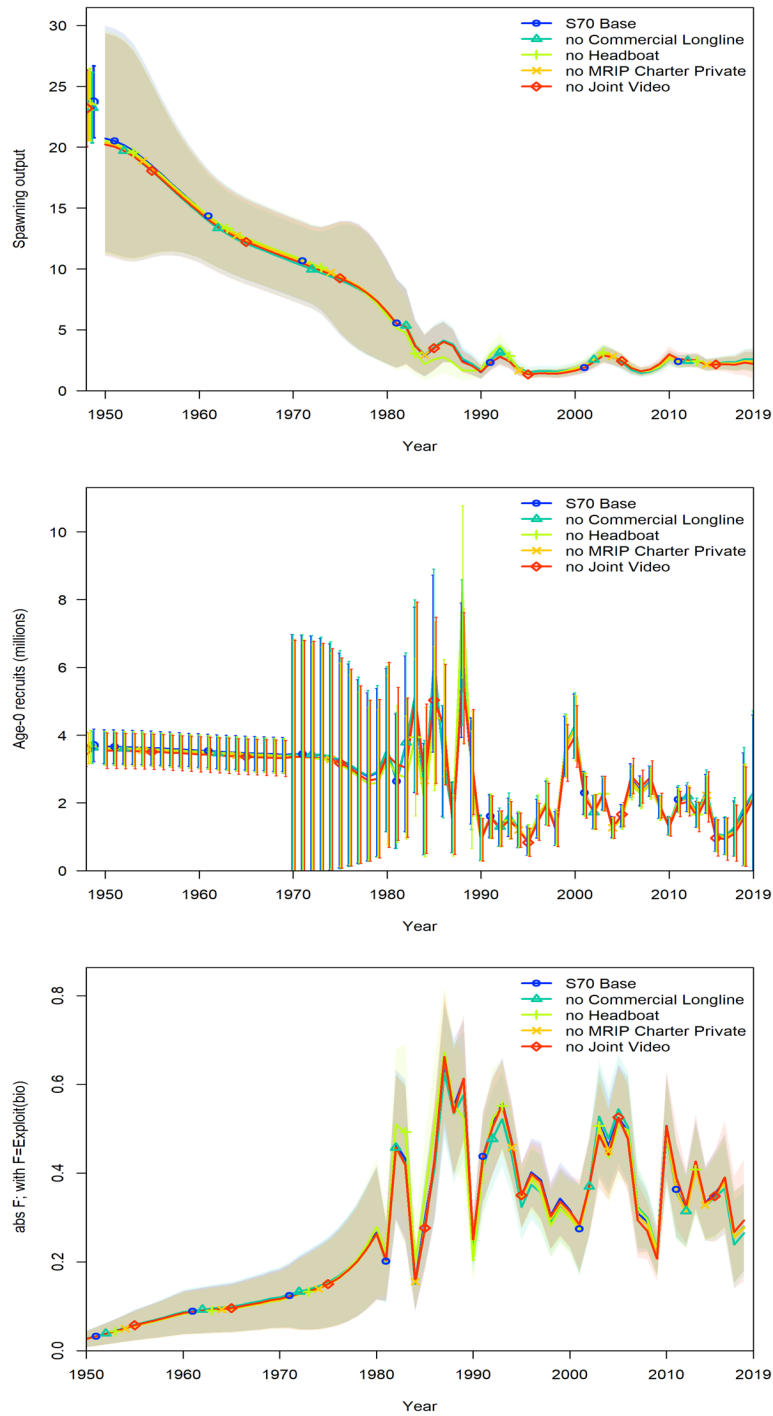

Figure 66. Estimates of spawning biomass (metric tons; top panel), recruitment (millions of fish; middle panel), and fishing mortality (total biomass killed age 1+ / total biomass age 1+; bottom panel) for the sensitivity runs removing each index of abundance conducted for Gulf of Mexico Greater Amberjack.

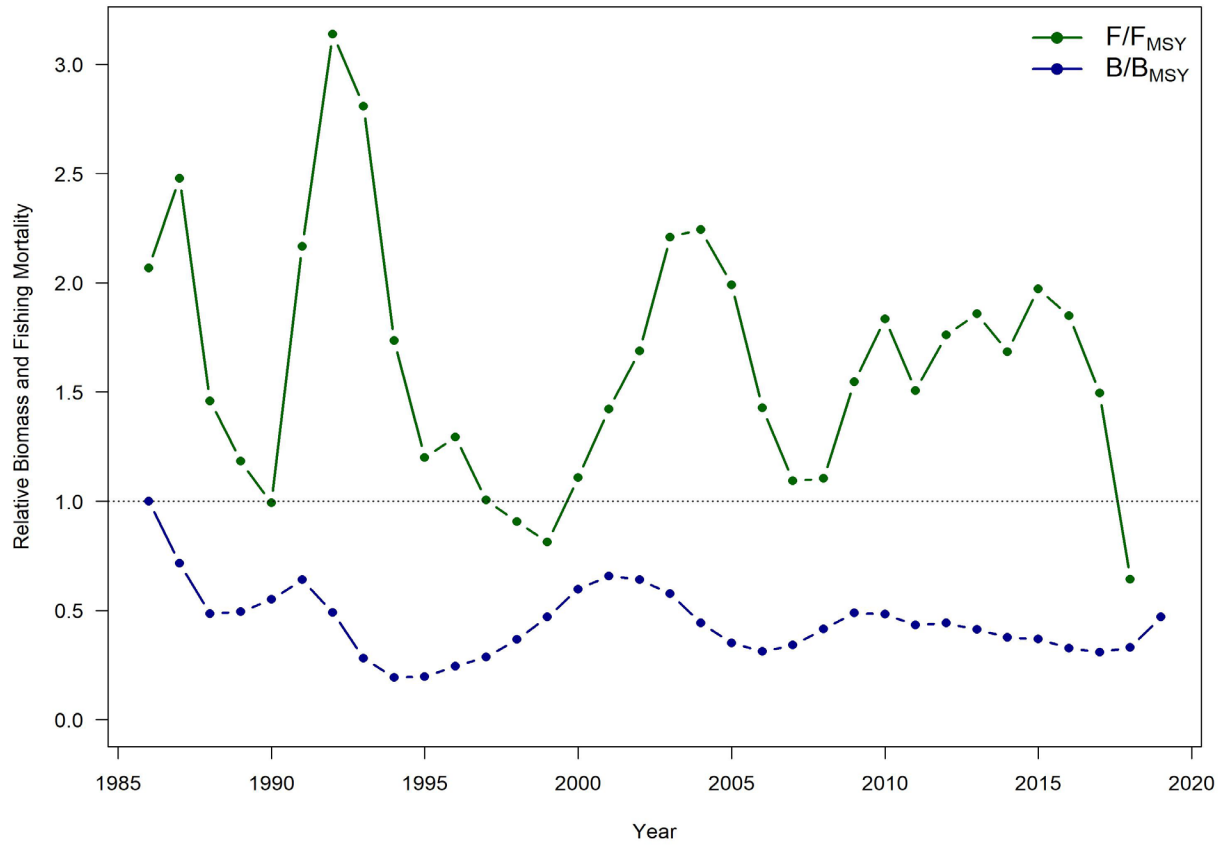

Figure 67. Estimated relative biomass (B/B_{MSY}) and relative F (F/F_{MSY}) trajectories for the SEDAR70 ASPIC Production Model.

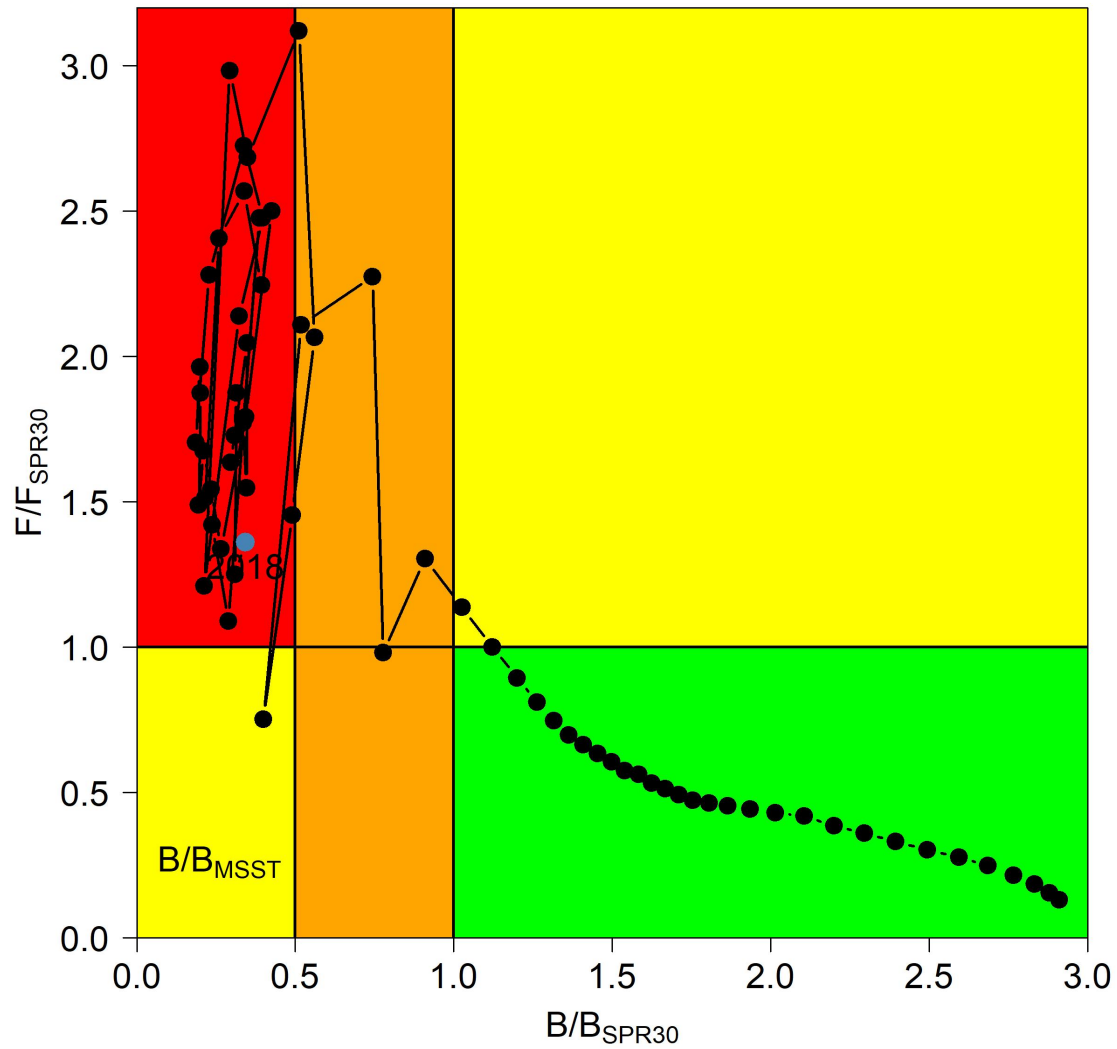

Figure 68. Kobe plot illustrating the trajectory of stock status. The orange coloring indicates regions where the stock is below the biomass target but above the biomass threshold ($MSST = 0.5 \times SSB_{SPR30\%}$). The 2018 terminal year stock status is indicated by the gray dot. See **Table 24** for specifics on the years above $F/F_{SPR30}=1$ and below $B/B_{MSST}<0.5$.

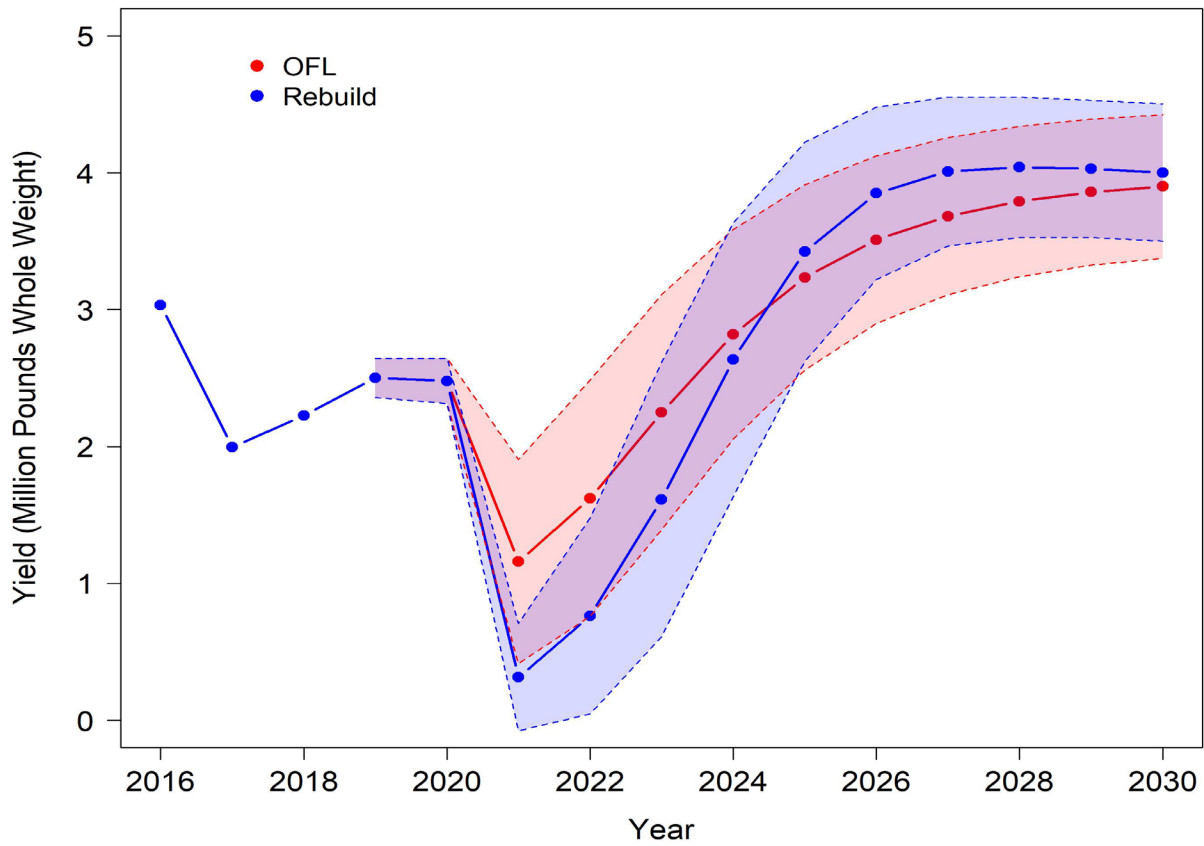

Figure 69. Historic (2016 – 2019) and forecasted yields with 95% uncertainty bands for the OFL projections (red) and $F_{Rebuild}$ projections (blue).