

SEDAR
Southeast Data, Assessment, and Review

SEDAR 68
Stock Assessment Report

Gulf of Mexico Scamp Grouper

September 2021

SEDAR
4055 Faber Place Drive, Suite 201
North Charleston, SC 29405

Table of Contents

| | | |
|--|----------|-----|
| Section I. Introduction | PDF page | 3 |
| Section II. Data Workshop Report | PDF page | 28 |
| Section III. Assessment Workshop Report | PDF page | 229 |
| Section IV. Research Recommendations | PDF page | 398 |
| Section V. Review Workshop Report | PDF page | 406 |
| Section VI. Post-Review Workshop Addenda | PDF pg | 419 |

SEDAR

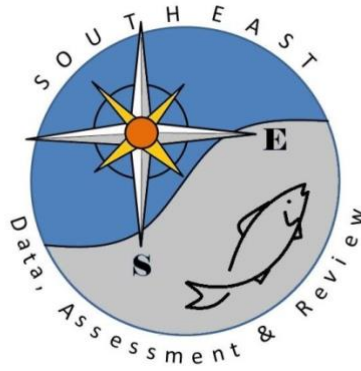

Southeast Data, Assessment, and Review

SEDAR 68

Gulf of Mexico Scamp Grouper

SECTION I: Introduction

SEDAR

4055 Faber Place Drive, Suite 201
North Charleston, SC 29405

Overview

SEDAR 68 addressed the stock assessments for Atlantic and Gulf of Mexico Scamp Grouper. The process consisted of a series of webinars. The Data Workshop was originally scheduled for March 2020, but due to the COVID-19 pandemic, was cancelled. The Data Process transitioned to webinars, which were held between March and September 2020. The Assessment Process was conducted via webinars December 2020 - May 2021, and the Review Workshop was held virtually August 31-September 3, 2021.

The first stage of the Data Process was a Stock ID review. This process was conducted via a series of webinars. The primary findings of the Stock ID Workshop were twofold. First, there is no evidence in support of biological substructure of the Scamp population off the Southeastern United States. Second, Scamp are very difficult to distinguish from Yellowmouth Grouper, even for trained biologists, and thus much of the assessment data likely represent both species in unknown proportions. In line with these findings, the Stock ID Workshop recommended that two stock assessments be conducted, separated by the default boundary between the Gulf of Mexico and Atlantic waters, as defined by the Councils' jurisdictions. Further, the Stock ID Workshop recommended that each assessment (Gulf of Mexico, Atlantic) be conducted on both Scamp and Yellowmouth Grouper jointly, with the two species treated as a single complex.

The Stock Assessment Report is organized into 6 sections. Section I – Introduction contains a brief description of the SEDAR Process, Assessment and Management Histories for the species of interest, and the management specifications requested by the Cooperator. The Data Workshop Report can be found in Section II. It documents the discussions and data recommendations from the Data Workshop Panel. Section III is the Assessment Process report. This section details the assessment model, as well as documents any changes to the data recommendations that may have occurred after the data workshop. Consolidated Research Recommendations from all three stages of the process (data, assessment, and review) can be found in Section IV for easy reference. Section V documents the discussions and findings of the Review Workshop (RW). Finally, Section VI – Addenda and Post-Review Workshop Documentation consists of any analyses conducted during or after the RW to address reviewer concerns or requests. It may also contain documentation of the final RW-recommended base model, should it differ from the model put forward in the Assessment Report for review.

The final Stock Assessment Report (SAR) for Gulf of Mexico scamp was disseminated to the public in September 2021. The Gulf of Mexico and South Atlantic Council's Scientific and Statistical Committee (SSC) will review the SAR. The SSCs are tasked with recommending whether the assessments represent Best Available Science, whether the results presented in the SARs are useful for providing management advice and developing fishing level recommendations for the Council. An SSC may request additional analyses be conducted or may use the information provided in the SAR as the basis for their Fishing Level Recommendations (e.g., Overfishing Limit and Acceptable Biological Catch). A review of the assessment will be conducted by the Gulf of Mexico Fishery Management Council's SSC in January 2022, followed by the Council receiving that information at its April 2022. Documentation on SSC recommendations are not part of the SEDAR process and is handled through each Council.

1 SEDAR PROCESS DESCRIPTION

SouthEast Data, Assessment, and Review (**SEDAR**) is a cooperative Fishery Management Council process initiated in 2002 to improve the quality and reliability of fishery stock assessments in the South Atlantic, Gulf of Mexico, and US Caribbean. SEDAR seeks improvements in the scientific quality of stock assessments and the relevance of information available to address fishery management issues. SEDAR emphasizes constituent and stakeholder participation in assessment development, transparency in the assessment process, and a rigorous and independent scientific review of completed stock assessments.

SEDAR is managed by the Caribbean, Gulf of Mexico, and South Atlantic Regional Fishery Management Councils in coordination with NOAA Fisheries and the Atlantic and Gulf States Marine Fisheries Commissions. Oversight is provided by a Steering Committee composed of NOAA Fisheries representatives: Southeast Fisheries Science Center Director and the Southeast Regional Administrator; Regional Council representatives: Executive Directors and Chairs of the South Atlantic, Gulf of Mexico,

and Caribbean Fishery Management Councils; a representative from the Highly Migratory Species Division of NOAA Fisheries, and Interstate Commission representatives: Executive Directors of the Atlantic States and Gulf States Marine Fisheries Commissions.

SEDAR is normally organized around two workshops and a series of webinars. First is the Data Workshop, during which fisheries, monitoring, and life history data are reviewed and compiled. The second stage is the Assessment Process, which is conducted via a workshop and/or a series of webinars, during which assessment models are developed and population parameters are estimated using the information provided from the Data Workshop. The final step is the Review Workshop, during which independent experts review the input data, assessment methods, and assessment products. The completed assessment, including the reports of all 3 stages and all supporting documentation, is then forwarded to the Council SSC for certification as ‘appropriate for management’ and development of specific management recommendations.

SEDAR workshops are public meetings organized by SEDAR staff and the lead Cooperator. Workshop participants are drawn from state and federal agencies, non-government organizations, Council members, Council advisors, and the fishing industry with a goal of including a broad range of disciplines and perspectives. All participants are expected to contribute to the process by preparing working papers, contributing, providing assessment analyses, and completing the workshop report.

2 SCAMP MANAGEMENT OVERVIEW

2.1 Fishery Management Plans and Amendments

The following summary describes only those management actions that likely affect Scamp and Yellowmouth Grouper fisheries and harvest.

Original GMFMC FMP

The Reef Fish Fishery Management Plan was implemented in November 1984. The regulations, designed to rebuild declining reef fish stocks, included: (1) prohibitions on the use of fish traps, roller trawls, and powerhead-equipped spear guns within an inshore stressed area; (2) a minimum size limit of 13 inches total length (TL) for red snapper with the exceptions that for-hire boats were exempted until 1987 and each angler could keep 5 undersize fish; and, (3) data reporting requirements.

GMFMC FMP Amendments affecting Scamp:

| Description of Action | FMP/Amendment | Effective Date |
|---|---------------|----------------|
| Set an 11.0 million-pound commercial quota for groupers, with the commercial quota divided into a 9.2 million pound shallow-water grouper quota and a 1.8 million-pound deepwater grouper quota. Shallow-water grouper were defined as black grouper, gag, red grouper, Nassau grouper, yellowfin grouper, yellowmouth grouper, rock hind, red hind, speckled hind, and scamp (until the shallow-water grouper quota is filled). Goliath grouper (jewfish) are not included in the quotas. Established a longline and buoy gear boundary and expanded the stressed area to the entire Gulf coast. Established a commercial reef fish permit. | Amendment 1 | 1990 |
| Established a moratorium on the issuance of new reef fish permits for a maximum period of three years; established an allowance for permit transfers | Amendment 4 | 1992 |

| | | |
|---|---------------|------|
| Created an Alabama special management zone (SMZ) with fishing gear restricted to no more than three hooks within the SMZ, and a framework procedure for future specification of SMZs. Established restrictions on the use of fish traps in the Gulf of Mexico EEZ, and implemented a three-year moratorium on the use of fish traps by creating a fish trap endorsement. Required that finfish be landed head and tails intact | Amendment 5 | 1994 |
| Established reef fish dealer permitting and record keeping. | Amendment 7 | 1994 |
| Extended the reef fish permit moratorium through December 31, 1995 and allowed collections of commercial landings data for initial allocation of individual transferable quota (ITQ) shares. Established historical captain status for purposes of ITQ allocation. | Amendment 9 | 1994 |
| Attempted to establish an ITQ system, which was then repealed by Congress | Amendment 8 | 1995 |
| Implemented a new commercial reef fish permit moratorium for no more than five years or until December 31, 2000, permitted dealers can only buy reef fish from permitted vessels and permitted vessels can only sell to permitted dealers, established a charter and headboat reef fish permit. | Amendment 11 | 1996 |
| Initiated a 10-year phase-out on the use of fish traps in the EEZ from February 7, 1997 to February 7, 2007, after which fish traps would be prohibited, and prohibited the use of fish traps west of Cape San Blas, Florida. | Amendment 14 | 1997 |
| Prohibited harvest of reef fish from traps other than permitted reef fish traps, stone crab traps, or spiny lobster traps. Established 2-tier red snapper license system (Class 1 & 2). | Amendment 15 | 1998 |
| (1) The possession of reef fish exhibiting the condition of trap rash on board any vessel with a reef fish permit that is fishing spiny lobster or stone crab traps is prima facie evidence of illegal trap use and is prohibited except for vessels possessing a valid fish trap endorsement; (2) that NOAA Fisheries establish a system design, implementation schedule, and protocol to require implementation of a vessel monitoring system (VMS) for vessels engaged in the fish trap fishery, with the cost of the vessel equipment, installation, and maintenance to be paid or arranged by the owners as appropriate; and, (3) that fish trap vessels submit trip initiation and trip termination reports. Prior to implementing this additional reporting requirement, there will be a one-month fish trap inspection/compliance/education period, at a time determined by the NOAA Fisheries Regional Administrator and published in the <i>Federal Register</i> . During this window of opportunity, fish trap fishermen will be required to have an appointment with NMFS enforcement for the purpose of having their trap gear, permits, and vessels available for inspection. The disapproved measure was a proposal to prohibit fish traps | Amendment 16A | 1998 |

| | | |
|---|---------------|------|
| south of 25.05 degrees north latitude beginning February 7, 2001. The status quo 10-year phase-out of fish traps in areas in the Gulf EEZ is therefore maintained. | | |
| Extended the commercial reef fish permit moratorium for another five years, from its previous expiration date of December 31, 2000 to December 31, 2005 | Amendment 17 | 2000 |
| Prohibited vessels with commercial harvests of reef fish aboard from also retaining fish caught under recreational bag and possession limits. Vessels with both for-hire and commercial permits were limited to the minimum crew size outlined in its Certificate of Inspection when fishing commercially. Prohibited the use of reef fish other than sand perches for bait. Required commercially permitted reef fish vessels to be equipped with VMS. | Amendment 18A | 2006 |
| Established two marine reserve areas off the Tortugas area and prohibits fishing for any species and anchoring by fishing vessels inside the two marine reserves. | Amendment 19 | 2002 |
| Established a 3-year moratorium on the issuance of new charter and headboat vessel permits in the recreational for hire fisheries in the Gulf EEZ. Allowed transfer of permits. Required vessel captains/owners to participate in data collection efforts. | Amendment 20 | 2002 |
| Continues the Madison-Swanson and Steamboat Lumps marine reserves for an additional 6 years, until July 2010. Modified the fishing restrictions within the reserves to allow surface trolling during May – October. | Amendment 21 | 2004 |
| Established bycatch reporting methodologies for the reef fish fishery. | Amendment 22 | 2005 |
| Extended the commercial reef fish permit moratorium indefinitely. Established a permanent limited access system for the commercial fishery for Gulf reef fish. Permits issued under the limited access system are renewable and transferable. | Amendment 24 | 2005 |
| Extended the recreational for-hire reef fish permit moratorium indefinitely. Established a limited access system on for-hire reef fish and CMP permits. Permits are renewable and transferable in the same manner as currently prescribed for such permits. | Amendment 25 | 2006 |
| Requires all commercial and recreational reef fish fisheries to use non-stainless steel circle hooks when using natural baits, as well as venting tools and dehooking devices. | Amendment 27 | 2008 |
| Established an individual fishing quota (IFQ) system for the commercial grouper and tilefish fishery, which began January 1, 2010. | Amendment 29 | 2009 |

| | | |
|--|----------------------|-------------|
| <p>Established annual catch limits (ACLs) and accountability measures (AMs) for the commercial and recreational gag fisheries, and commercial aggregate shallow-water grouper fishery.</p> <p>For the commercial sector, the amendment for 2009 reduces the aggregate shallow-water grouper quota from 8.80 mp to 7.8 mp.</p> <p>The Steamboat Lumps and Madison-Swanson fishing area restrictions were continued indefinitely.</p> <p>For the recreational sector, the amendment reduces the aggregate grouper bag limit from five fish to four. A recreational closed season on shallow-water grouper was established from February 1 through March 31.</p> <p>Finally, the amendment requires that all vessels with federal commercial or charter reef fish permits must comply with the more restrictive of state or federal reef fish regulations when fishing in state waters.</p> | <p>Amendment 30B</p> | <p>2009</p> |
| <p>Longline endorsement requirement - Vessels must have average annual reef fish landings of 40,000 pounds gutted weight or more from 1999 through 2007. The longline boundary in the eastern Gulf is extended from the 20-fathom depth contour to the 35-fathom depth contour from June - August. Vessels are limited to 1000 hooks of which no more than 750 of which can be rigged for fishing or fished.</p> | <p>Amendment 31</p> | <p>2010</p> |

GMFMC Regulatory Amendments:

July 1991:

The 1991 quota for shallow-water groupers was increased to 9.9 million pounds whole weight (using a revised gutted to whole weight conversion factor of 1.05 rather than 1.18, this corresponded to 8.8 million pounds whole weight). This action was taken to provide the commercial sector an opportunity to harvest 0.7 million pounds that went unharvested in 1990 due to an early closure of the fishery in 1990. NMFS had projected that the 9.2 million pound whole weight quota would be reached on November 7, but subsequent data showed that the actual harvest was 8.5 million pounds whole weight (or 7.6 million pounds whole weight using the revised gutted to whole weight conversion factor).

November 1991:

Set the 1992 commercial quota for shallow-water groupers at 9.8 million pounds in adjusted whole weights. This reflected an increase of 1.6 million pounds plus an adjustment in the gutted to whole weight conversion factor from 1.18 to 1.05.

August 1999:

Implemented June 19, 2000- Established two marine reserves (Madison-Swanson and Steamboat Lumps) on areas suitable for gag and other reef fish spawning aggregations sites that are closed year-round to fishing for all species under the Council’s jurisdiction. The two sites cover 219 square nautical miles near the 40-fathom contour, off west central Florida.

October 2005:

Implemented January 2006 – Established an aggregate commercial trip limit of 6,000 pounds gutted weight for both deep-water grouper and shallow-water grouper combined.

March 2006:

Implemented July 2006 - Prohibits captain and crew of for-hire vessels from retaining grouper when under charter.

August 2010:

Effective January 2011 - Provides a more specific definition of buoy gear by limiting the number of hooks, limiting the terminal end weight, restricting materials used for the line, restricting the

length of the drop line, and where the hooks may be attached. In addition, the Council requested that each buoy must display the official number of the vessel (USCG documentation number or state registration number) to assist law enforcement in monitoring the use of the gear, which requires rulemaking.

July 2013:

Effective July 5, 2013 - Eliminated the February 1 through March 31 shallow-water grouper closure shoreward of 20 fathoms.

2.2 Emergency and Interim Rules

December 17, 2002- The National Marine Fisheries Service published an emergency rule that extended certain permit-related deadlines contained in the final rule implementing the for-hire (charter vessel/headboat) permit moratorium for reef fish and coastal migratory pelagic fish in the Gulf of Mexico (Gulf). This emergency rule was implemented because the final rule implementing the for-hire permit moratorium contained an error regarding eligibility that needed to be resolved as soon as possible. In addition, the regulations that implemented the moratorium required all for-hire vessels operating in the Gulf reef fish or coastal migratory pelagic fisheries in federal waters to have a valid "moratorium permit," as opposed to the prior open access charter permit, beginning December 26, 2002.

March 3, 2005 – An emergency rule established a commercial trip limit of 10,000 pounds for all grouper combined; reduce the trip limit to 7,500 pounds when 50 percent of either the shallow- water grouper or red grouper quota was reached; and reduce the trip limit to 5,500 pounds when 75 percent of either the shallow-water grouper or red grouper quota was reached. Fifty percent of the quota was reached on June 9 and trip limits were reduced to 7,500 pounds. The deep- water grouper quota was reached on June 23 and that component was closed. Seventy-five percent of the shallow-water grouper quota was reached on August 4 and trip limits were reduced to 5,500 pounds. The shallow-water grouper component closed on October 10.

April 1, 2005 - The National Marine Fisheries Service published an emergency rule to reopen the application process for obtaining Gulf charter vessel/headboat permits under moratorium. Permit owners who received their Gulf charter vessel/headboat permits under the moratorium, or a letter of eligibility for such a permit, need not reapply. This reopening is extended to historical participants in the fishery who, for whatever reason, failed to apply during the moratorium application period.

August 9, 2005 - NOAA's National Marine Fisheries Service (NMFS) published a temporary rule in the Federal Register implementing management measures for the recreational grouper fishery in the exclusive economic zone of the Gulf of Mexico, as requested by the Gulf of Mexico Fishery Management Council, to reduce overfishing of red grouper. This rule establishes a seasonal closure of the recreational fishery for all Gulf grouper species from November 1 through December 31, 2005 and reduces both the recreational bag limit for red grouper and the aggregate grouper bag limit. The intended effects are to reduce overfishing of red grouper in the Gulf of Mexico and to minimize potential adverse impacts on other grouper stocks that could result from a shift in fishing effort from red grouper to other grouper species. (A legal challenge resulted in a ruling that the November 1 through December 31 seasonal closure could, under an interim rule, only be applied to the stock that was undergoing overfishing, i.e., red grouper.)

January 1, 2009 - NOAA's National Marine Fisheries Service (NOAA Fisheries Service) has published a final rule implementing interim measures in the Gulf of Mexico reef fish fishery. The rule published in the Federal Register on December 2, 2008, and the measures are effective January 1, 2009. The Gulf of Mexico Fishery Management Council (Council) requested a temporary rule be effective at the beginning

of 2009 to address overfishing of gag, as well as red snapper, greater amberjack, and gray triggerfish until more permanent measures can be implemented through Amendment 30B to the Fishery Management Plan for the Reef Fish Resources of the Gulf of Mexico. The Council developed Amendment 30B to end overfishing of gag, revise shallow-water grouper management measures in light of new information on gag and red grouper stocks, and improve the effectiveness of federal management measures. NOAA Fisheries Service is presently reviewing Amendment 30B with subsequent rulemaking occurring later in 2009. New Management Measures The interim rule will: 1) Establish a two-fish gag recreational bag limit (recreational grouper aggregate bag limit will remain at 5 fish); 2) Adjust the recreational closed season for gag to February 1 through March 31 (the recreational closed season for red and black groupers will remain February 15 to March 15); 3) Establish a 1.32 million pound commercial quota for gag; and 4) Require operators of federally permitted Gulf of Mexico commercial and for-hire reef fish vessels to comply with the more restrictive of federal or state reef fish regulations when fishing in state waters for red snapper, greater amberjack, gray triggerfish, and gag.

May 18, 2009 - NOAA Fisheries Service implemented an emergency rule, effective May 18, 2009, through October 28, 2009, to reduce the sea turtle bycatch in the Gulf of Mexico bottom longline reef fish fishery. The emergency rule prohibits bottom longlining for Gulf reef fish east of 85° 30'W longitude (near Cape San Blas, Florida) in a portion of the Exclusive Economic Zone shoreward of the 50-fathom depth contour. Once the deepwater grouper and tilefish quotas have been filled, the use of bottom longline gear to harvest reef fish in water of all depths east of 85° 30'W longitude will be prohibited. During transit no reef fish may be possessed unless bottom longline gear is appropriately stowed meaning that a longline may be left on the drum if all gangions and hooks are disconnected and stowed below deck; hooks cannot be baited, and all buoys must be disconnected from the gear, but may remain on deck.

May 2, 2010 - NOAA Fisheries Service is enacting emergency regulations to close a portion of the Gulf of Mexico (Gulf) exclusive economic zone (EEZ) to all fishing, in response to the Deepwater Horizon oil spill. The closure will be in effect for 10 days, from May 2, 2010, through 12:01 a.m. local time May 12, 2010, unless conditions allow NOAA Fisheries Service to terminate it sooner. NOAA Fisheries Service will continue to monitor and evaluate the oil spill and its impacts on Gulf fisheries and will take immediate and appropriate action to extend or reduce this closed area. This closure is implemented for public safety (subsequent frequent adjustments were made to the closed area during the summer of 2010).

2.3 Secretarial Amendments

Secretarial Amendment 1 (2004)

Implemented July 15, 2004- Changed the quota for deep-water grouper from 1.6 million pounds whole weight (equal to 1.35 million pounds landed weight) to a gutted weight quota of 1.02 million pounds (equal to the average annual harvest 1996-2000).

2.4 Control Date Notices

Control date notices are used to inform fishermen that a license limitation system or other method of limiting access to a particular fishery or fishing method is under consideration. If a program to limit access is established, anyone not participating in the fishery or using the fishing method by the published control date may be ineligible for initial access to participate in the fishery or to use that fishing method. However, a person who does not receive an initial eligibility may be able to enter the fishery or fishing method after the limited access system is established by transfer of the eligibility from a current participant, provided the limited access system allows such transfer. Publication of a control date does not obligate the Council to use that date as an initial eligibility criteria. A different date could be used, and additional qualification criteria could be established. The announcement of a control date is primarily intended to discourage entry into the fishery or use of a particular gear based on economic speculation during the Council's deliberation on the issues. The following summarizes control dates that have been established for the Reef Fish FMP. A reference to the full *Federal Register* notice is included with each summary.

November 1, 1989:

Anyone entering the commercial reef fish fishery in the Gulf and South Atlantic after November 1, 1989, may not be assured of future access to the reef fish resource if a management regime is developed and implemented that limits the number of participants in the fishery [54 FR 46755].

November 18, 1998:

The Council is considering whether there is a need to impose additional management measures limiting entry into the recreational-for-hire (i.e., charter vessel and headboat) fisheries for reef fish and coastal migratory pelagic fish in the EEZ of the Gulf and, if there is a need, what management measures should be imposed. Possible measures include the establishment of a limited entry program to control participation or effort in the recreational-for-hire fisheries for reef fish and coastal migratory pelagic [63 FR 64031] (In Amendment 20 to the Reef Fish FMP, a qualifying date of March 29, 2001, was adopted).

July 12, 2000:

The Council is considering whether there is a need to limit participation by gear type in the commercial reef fish fisheries in the exclusive economic zone of the Gulf and, if there is a need, what management measures should be imposed to accomplish this. Possible measures include modifications to the existing limited entry program to control fishery participation, or effort, based on gear type, such as a requirement for a gear endorsement on the commercial reef fish vessel permit for the appropriate gear. Gear types which may be included are longlines, buoy gear, handlines, rod-and-reel, bandit gear, spear fishing gear, and powerheads used with spears [65 FR 42978].

October 15, 2004:

The Council is considering the establishment of an individual fishing quota program to control participation or effort in the commercial grouper fisheries of the Gulf. If an individual fishing quota program is established, the Council is considering October 15, 2004, as a possible control date regarding the eligibility of catch histories in the commercial grouper fishery [69 FR 67106].

December 31, 2008:

The Council voted to establish a control date for all Gulf commercial reef fish vessel permits. The control date will allow the Council to evaluate fishery participation and address any level of overcapacity. The establishment of this control date does not commit the Council or NOAA Fisheries Service to any particular management regime or criteria for entry into this fishery.

Fishermen would not be guaranteed future participation in the fishery regardless of their entry date or intensity of participation in the fishery before or after the control date under consideration. Comments were requested by close of business April 17, 2009 [74 FR 11517].

2.5 Management Program Specifications

Table 2.5.1. General Management Information Gulf of Mexico

| | |
|---------------------------------------|---|
| Species | Scamp |
| Management Unit | Gulf of Mexico |
| Management Unit Definition | Gulf of Mexico EEZ |
| Management Entity | Gulf of Mexico Fishery management Council |
| Management Contacts SERO/Council | Peter Hood/ Ryan Rindone |
| Current stock exploitation status | Unknown |
| Current spawning stock biomass status | Unknown |

Table 2.5.2. Specific Management Criteria

| Criteria | Gulf of Mexico - Proposed | |
|-----------------|-----------------------------------|----------|
| | Definition | Value |
| MSST | $1-M*SSB_{MSY}$ | SEDAR OA |
| SSB_{MSY} | | SEDAR OA |
| $SSB_{Current}$ | SSB_{2021} | SEDAR OA |
| MFMT | F_{MSY} | SEDAR OA |
| MSY | F_{MSY} | SEDAR OA |
| FMSY | | SEDAR OA |
| $F_{Current}$ | Geom mean of last 3 fishing years | SEDAR OA |
| OY | Equilibrium yield at F_{MSY} | SEDAR OA |
| FOY | 75% of F_{MSY} | SEDAR OA |
| M | - | SEDAR OA |

NOTE: “Proposed” columns are for indicating any definitions that may exist in FMPs or amendments that are currently under development and should therefore be evaluated in the current assessment. “Current” is those definitions in place now. Please clarify whether landings parameters are ‘landings’ or ‘catch’ (Landings + Discard). If ‘landings’, please indicate how discards are addressed.

Stock Rebuilding Information

Gulf of Mexico scamp is not currently under a rebuilding plan.

Table 2.5.4. Stock projection information

(This provides the basic information necessary to bridge the gap between the terminal year of the assessment and the year in which any changes may take place or specific alternative exploitation rates should be evaluated)

Gulf of Mexico

| Requested Information | Value |
|--|---|
| First Year of Management | 2023 |
| Projection Criteria during interim years should be based on (e.g., exploitation or harvest) | Fixed Exploitation |
| Projection criteria values for interim years should be determined from (e.g., terminal year, average of X years) | Actual or preliminary landings; else, average of previous 3 years |

*Fixed Exploitation would be $F=F_{MSY}$ (or $F<F_{MSY}$) that would rebuild overfished stock to B_{MSY} in the allowable timeframe. Modified Exploitation would be allow for adjustment in $F<=F_{MSY}$, which would allow for the largest landings that would rebuild the stock to B_{MSY} in the allowable timeframe. Fixed harvest would be maximum fixed harvest with $F<=F_{MSY}$ that would allow the stock to rebuild to B_{MSY} in the allowable timeframe.

Project future stock conditions and develop rebuilding schedules if warranted, including estimated generation time. Develop stock projections in accordance with the following:

- A) If stock is overfished:
 F=0, F_{Current}, F_{MSY}, F_{OY}
 F=F_{Rebuild} (max that permits rebuild in allowed time)
- B) If stock is undergoing overfishing:
 F= F_{Current}, F_{MSY}, F_{OY}
- C) If stock is neither overfished nor undergoing overfishing:
 F= F_{Current}, F_{MSY}, F_{OY}
- D) If data limitations preclude classic projections (i.e. A, B, C above), explore alternate models to provide management advice

Table 2.5.5. Quota Calculation Details

If the stock is managed by quota, please provide the following information

| | |
|---|------------|
| Current Quota Value | 1.35 mp gw |
| Next Scheduled Quota Change | 2022 |
| Annual or averaged quota? | Annual |
| If averaged, number of years to average | - |
| Does the quota include bycatch/discard? | No |

2.6 Federal Management and Regulatory Timelines for Scamp and Yellowmouth Groupers

Harvest Restrictions (Trip Limits*)

*Trip limits do not apply during closures (if season is closed, then trip limit is 0)

| First Yr In Effect | Last Yr In Effect | Effective Date | End Date | Fishery | Bag Limit Per Person/Day | Trip Limit Per Boat/Day | Region Affected | FR Reference | FR Section | Amendment Number or Rule Type |
|--------------------|-------------------|----------------|----------|---------|--------------------------|--|--------------------|--------------|------------|--------------------------------|
| 2005 | 2005 | 3/3/05 | 6/8/05 | Com | NA | 10,000 lbs gw; DWG ¹ & SWG ² | Gulf of Mexico EEZ | 70 FR 8037 | 622.44 | Emergency Rule |
| 2005 | 2005 | 6/9/05 | 8/3/05 | Com | NA | 7,500 lbs gw; DWG ¹ & SWG ² | Gulf of Mexico EEZ | 70 FR 33033 | 622.44 | Temporary Rule |
| 2005 | 2005 | 8/4/05 | 12/31/05 | Com | NA | 5,500 lbs gw; SWG ² | Gulf of Mexico EEZ | 70 FR 42279 | 622.44 | Temporary Rule |
| 2006 | 2009 | 1/1/06 | 12/31/09 | Com | NA | 6,000 lbs gw; DWG ¹ & SWG ² | Gulf of Mexico EEZ | 70 FR 77057 | 622.44 | Reef Fish Regulatory Amendment |
| 2010 | Ongoing | 1/1/10 | Ongoing | Com | NA | IFQ | Gulf of Mexico EEZ | 74 FR 44732 | 622.2 | Reef Fish Amendment 29 |
| 1990 | 2004 | 4/23/90 | 7/14/04 | Rec | 5 grouper aggregate | NA | Gulf of Mexico EEZ | 55 FR 2078 | 641.24 | Reef Fish Amendment 1 |
| 2004 | 2005 | 7/15/04 | 8/8/05 | Rec | 5 grouper aggregate | NA | Gulf of Mexico EEZ | 69 FR 33315 | 622.39 | Secretarial Amendment 1 |
| 2005 | 2006 | 8/9/05 | 1/23/06 | Rec | 3 grouper aggregate | NA | Gulf of Mexico EEZ | 70 FR 42510 | 622.39 | Temporary Rule |
| 2006 | 2009 | 1/24/06 | 5/17/09 | Rec | 5 grouper aggregate | NA | Gulf of Mexico EEZ | 71 FR 3018 | 622.39 | Temporary Rule |
| | | | | | | | | 71 FR 34534 | | Reef Fish Regulatory Amendment |
| 2009 | Ongoing | 5/18/09 | Ongoing | Rec | 4 grouper aggregate | NA | Gulf of Mexico EEZ | 74 FR 17603 | 622.39 | Reef Fish Amendment 30B |

¹DWG: deep-water grouper (misty grouper, snowy grouper, yellowedge grouper, warsaw grouper, and speckled hind)

²SWG: shallow-water grouper (black, gag, red, red hind, rock hind, scamp, yellowfin, and yellowmouth)

Note: Once all of an IFQ account holder's other SWG allocation has been landed and sold, or transferred, or if an IFQ account holder has no SWG allocation, then DWG allocation may be used to land and sell scamp.

Harvest Restrictions (Size Limits*)

*Size limits do not apply during closures

| First Yr In Effect | Last Yr In Effect | Effective Date | End Date | Fishery | Size Limit | Length Type | Region Affected | FR Reference | FR Section | Amendment Number or Rule Type |
|--------------------|-------------------|----------------|----------|---------|------------|-------------|--------------------|--------------|------------|-------------------------------|
| 1999 | Ongoing | 11/24/99 | Ongoing | Com | 16" | Minimum TL | Gulf of Mexico EEZ | 64 FR 57403 | 622.37 | Reef Fish Amendment 16B |
| 1999 | Ongoing | 11/24/99 | Ongoing | Rec | 16" | Minimum TL | Gulf of Mexico EEZ | 64 FR 57403 | 622.37 | Reef Fish Amendment 16B |

No size limits for Yellowmouth Grouper

Harvest Restrictions (Fishery Closures*)

*Area specific regulations are documented under spatial restrictions

| First Yr In Effect | Last Year in Effect | Effective Date | End Date | Fishery | Closure Type | First Day Closed | Last Day Closed | Region Affected | FR Reference | FR Section | Amendment Number or Rule Type | Species Associated with Closure |
|--------------------|---------------------|----------------|----------|---------|--------------|------------------|-----------------|--|--------------|------------|-------------------------------|--|
| 2004 | 2004 | 11/15/04 | 12/31/04 | Com | Quota | 15-Nov | 31-Dec | Gulf of Mexico EEZ | 69 FR 65092 | 622.43 | Notice of Closure | SWG: Black, Red, Gag, Scamp, Yellowfin, Rock Hind, Red Hind, and Yellowmouth |
| 2005 | 2005 | 10/10/05 | 12/31/05 | Com | Quota | 10-Oct | 31-Dec | Gulf of Mexico EEZ | 70 FR 57802 | 622.43 | Temporary Rule | SWG: Black, Red, Gag, Scamp, Yellowfin, Rock Hind, Red Hind, and Yellowmouth |
| 2005 | 2005 | 8/9/05 | 1/23/06 | Rec | Seasonal | 1-Nov | 31-Dec | Gulf of Mexico EEZ | 70 FR 42510 | 622.34 | Temporary Rule | Groupers |
| 2010 | 2013 | 5/18/09 | 7/4/13 | Rec | Seasonal | 1-Feb | 31-Mar | Gulf of Mexico EEZ | 74 FR 17603 | 622.34 | Reef Fish Amendment 30B | SWG: Black, Red, Gag, Scamp, Yellowfin, Rock Hind, Red Hind, and Yellowmouth |
| 2014 | Ongoing | 7/5/13 | Ongoing | Rec | Seasonal | 1-Feb | 31-Mar | Gulf of Mexico EEZ seaward of 20 fathoms | 78 FR 33259 | 622.34 | Reef Fish Framework Action | SWG: Black, Red, Gag, Yellowfin and Yellowmouth |

¹According to Fishery Bulletins, the 15-Feb to 15-Mar closures ended at 12:01 am 14-Mar, as such the last day closed is effectively 14-Mar (FB02-001, FB03-005, FB04-005, FB05-001, FB06-002, FB07-06, FB08-004, FB09-005)

Harvest Restrictions (Spatial Restrictions)

| Area | First Yr In Effect | Last Yr In Effect | Effective Date | End Date | Fishery | First Day Closed | Last Day Closed | Restriction in Area | FR Reference | FR Section | Amendment Number or Rule Type |
|--|--------------------|-------------------|----------------|----------|---------|------------------|-----------------|--|----------------------------|------------------|---|
| Gulf of Mexico Stressed Areas | 1984 | Ongoing | 11/8/84 | Ongoing | Both | Year round | | Prohibited powerheads for Reef FMP | 49 FR 39548 | 641.7 | Original Reef Fish FMP |
| | 1984 | Ongoing | 11/8/84 | Ongoing | Both | Year round | | Prohibited pots and traps for Reef FMP | 49 FR 39548 | 641.7 | Original Reef Fish FMP |
| Alabama Special Management Zones | 1994 | Ongoing | 2/7/94 | Ongoing | Both | Year round | | Allow only hook-and line gear with three or less hooks per line and spearfishing gear for fish in Reef FMP | 59 FR 966 | 641.23 | Reef Fish Amendment 5 |
| EEZ, inside 50 fathoms west of Cape San Blas, FL | 1990 | Ongoing | 2/21/90 | Ongoing | Both | Year round | | Prohibited longline and buoy gear for Reef FMP | 55 FR 2078 | 641.7 | Reef Fish Amendment 1 |
| EEZ, inside 20 fathoms east of Cape San Blas, FL | 1990 | Ongoing | 2/21/90 | Ongoing | Both | Year round | | Prohibited longline and buoy gear for Reef FMP | 55 FR 2078 | NA | Reef Fish Amendment 1 |
| EEZ, inside 50 fathoms east of Cape San Blas, FL | 2009 | 2009 | 5/18/09 | 10/15/09 | Both | | 18-May 28-Oct | Prohibited bottom longline for Reef FMP | 74 FR 20229 | 622.34 | Emergency Rule |
| EEZ, inside 35 fathoms east of Cape San Blas, FL | 2009 | 2010 | 10/16/09 | 5/25/10 | Both | Year round | | Prohibited bottom longline for Reef FMP | 74 FR 53889 | 223.206 | Sea Turtle ESA Rule |
| | 2010 | Ongoing | 5/26/10 | Ongoing | Rec | Year round | | Prohibited bottom longline for Reef FMP | 75 FR 21512 | 622.34 | Reef Fish Amendment 31 |
| | 2010 | Ongoing | 5/26/10 | Ongoing | Com | 1-Jun | 31-Aug | Prohibited bottom longline for Reef FMP | 75 FR 21512 | 622.34 | Reef Fish Amendment 31 |
| Madison-Swanson | 2000 | 2004 | 6/19/00 | 6/2/04 | Both | Year round | | Fishing prohibited except HMS ¹ | 65 FR 31827 | 622.34 | Reef Fish Regulatory Amendment |
| | 2004 | Ongoing | 6/3/04 | Ongoing | Both | 1-May | 31-Oct | Fishing prohibited except surface trolling | 70 FR 24532 74 FR 17603 | 622.34 NA | Reef Fish Amendment 21 Reef Fish Amendment 30B |
| | 2004 | Ongoing | 6/3/04 | Ongoing | Both | 1-Nov | 30-Apr | Fishing prohibited except HMS ¹ | 70 FR 24532 74 FR 17603 | 622.34 NA | Reef Fish Amendment 21 Reef Fish Amendment 30B |
| Steamboat Lumps | 2000 | 2004 | 6/19/00 | 6/2/04 | Both | Year round | | Fishing prohibited except HMS ¹ | 65 FR 31827 | 622.34 | Reef Fish Regulatory Amendment |
| | 2004 | Ongoing | 6/3/04 | Ongoing | Both | 1-May | 31-Oct | Fishing prohibited except surface trolling | 70 FR 24532 74 FR 17603 | 622.34 NA | Reef Fish Amendment 21 Reef Fish Amendment 30B |
| | 2004 | Ongoing | 6/3/04 | Ongoing | Both | 1-Nov | 30-Apr | Fishing prohibited except HMS ¹ | 70 FR 24532 74 FR 17603 | 622.34 NA | Reef Fish Amendment 21 Reef Fish Amendment 30B |
| The Edges | 2010 | Ongoing | 7/24/09 | Ongoing | Both | 1-Jan | 30-Apr | Fishing prohibited | 74 FR 30001 | 622.34 | Reef Fish Amendment 30B Supplement |
| 20 Fathom Break | 2014 | Ongoing | 7/5/13 | Ongoing | Rec | 1-Feb | 31-Mar | Fishing for SWG prohibited ² | 78 FR 33259 | 622.34 | Reef Fish Framework Action |
| Flower Garden | 1992 | Ongoing | 1/17/92 | Ongoing | Both | Year round | | Fishing with bottom gears prohibited ³ | 56 FR 63634 70 FR 76216 | 934 622.34 | Sanctuary Designation Essential Fish Habitat Amendment 3 |
| Riley's Hump | 1994 | 2002 | 2/7/94 | 8/18/02 | Both | 1-May | 30-Jun | Fishing prohibited | 59 FR 966 | 641.23 | Reef Fish Amendment 5 |
| Tortugas Reserves | 2002 | Ongoing | 8/19/02 | Ongoing | Both | Year round | | Fishing prohibited | 67 FR 47467 70 FR 76216 | 635.71 622.34 | Tortugas Amendment Essential Fish Habitat Amendment 3 |
| Pulley Ridge | 2006 | Ongoing | 1/23/06 | Ongoing | Both | Year round | | Fishing with bottom gears prohibited ³ | 70 FR 76216 | 622.34 | Essential Fish Habitat Amendment 3 |
| McGrail Bank | 2006 | Ongoing | 1/23/06 | Ongoing | Both | Year round | | Fishing with bottom gears prohibited ³ | 70 FR 76216 | 622.34 | Essential Fish Habitat Amendment 3 |
| Stetson Bank | 2006 | Ongoing | 1/23/06 | Ongoing | Both | Year round | | Fishing with bottom gears prohibited ³ | 70 FR 76216 | 622.34 | Essential Fish Habitat Amendment 3 |

¹HMS: highly migratory species (tuna species, marlin, oceanic sharks, sailfishes, and swordfish)

²SWG: shallow-water grouper (black, gag, red, red hind, rock hind, scamp, yellowfin, and yellowmouth)

³Bottom gears: Bottom longline, bottom trawl, buoy gear, pot, or trap

Harvest Restrictions (Gear Restrictions*)

*Area specific gear regulations are documented under spatial restrictions

| Gear Type | First Yr In Effect | Last Yr In Effect | Effective Date | End Date | Gear/Harvesting Restrictions | Region Affected | FR Reference | FR Section | Amendment Number or Rule Type |
|------------------|---------------------------|--------------------------|-----------------------|-----------------|--|------------------------|----------------------------|-------------------|--|
| Poison | 1984 | Ongoing | 11/8/84 | Ongoing | Prohibited for Reef FMP | Gulf of Mexico EEZ | 49 FR 39548 | 641.24 | Original Reef Fish FMP |
| Explosives | 1984 | Ongoing | 11/8/84 | Ongoing | Prohibited for Reef FMP | Gulf of Mexico EEZ | 49 FR 39548 | 641.24 | Original Reef Fish FMP |
| Pots and Traps | 1984 | 1994 | 11/23/84 | 2/6/94 | Established fish trap permit | Gulf of Mexico EEZ | 49 FR 39548 | 641.4 | Original Reef Fish FMP |
| | 1984 | 1990 | 11/23/84 | 2/20/90 | Set max number of traps fish by a vessel at 200 | Gulf of Mexico EEZ | 49 FR 39548 | 641.25 | Original Reef Fish FMP |
| | 1990 | 1994 | 2/21/90 | 2/6/94 | Set max number of traps fish by a vessel at 100 | Gulf of Mexico EEZ | 55 FR 2078 | 641.22 | Reef Fish Amendment 1 |
| | 1994 | 1997 | 2/7/94 | 2/7/97 | Moratorium on additional commercial trap permits | Gulf of Mexico EEZ | 59 FR 966 | 641.4 | Reef Fish Amendment 5 |
| | 1997 | 2007 | 3/25/97 | 2/7/07 | Phase out of fish traps begins | Gulf of Mexico EEZ | 62 FR 13983 | 622.4 | Reef Fish Amendment 14 |
| | 1997 | 2007 | 1/29/88 | 2/7/07 | Prohibited harvest of reef fish from traps other than permitted reef fish, stone crab, or spiny lobster traps. | Gulf of Mexico EEZ | 62 FR 67714 | 622.39 | Reef Fish Amendment 15 |
| | 2007 | Ongoing | 2/8/07 | Ongoing | Traps prohibited | Gulf of Mexico EEZ | 62 FR 13983 | 622.31 | Reef Fish Amendment 14 |
| All | 1992 | 1995 | 5/8/92 | 12/31/95 | Moratorium on commercial permits for Reef FMP | Gulf of Mexico EEZ | 59 FR 11914 59 FR 39301 | 641.4 641.4 | Reef Fish Amendment 4 Reef Fish Amendment 9 |
| | 1994 | Ongoing | 2/7/94 | Ongoing | Finfish must have head and fins intact through landing, can be eviscerated, gilled, and scaled but must otherwise be whole (HMS and bait exceptions) | Gulf of Mexico EEZ | 59 FR 966 | 641.21 | Reef Fish Amendment 5 |
| | 1996 | 2005 | 7/1/96 | 12/31/05 | Moratorium on commercial permits for Gulf reef fish | Gulf of Mexico EEZ | 61 FR 34930 65 FR 41016 | 622.4 622.4 | Interim Rule Reef Fish Amendment 17 |
| | 2006 | Ongoing | 9/8/06 | Ongoing | Use of Gulf reef fish as bait prohibited ¹ | Gulf of Mexico EEZ | 71 FR 45428 | 622.31 | Reef Fish Amendment 18A |
| Vertical Line | 2008 | Ongoing | 6/1/08 | Ongoing | Requires non-stainless steel circle hooks and dehooking devices | Gulf of Mexico EEZ | 74 FR 5117 | 322.41 | Reef Fish Amendment 27 |
| | 2008 | 2013 | 6/1/08 | 9/3/13 | Requires venting tools | Gulf of Mexico EEZ | 74 FR 5117 78 FR 46820 | 322.41 NA | Reef Fish Amendment 27 Framework Action |
| Bottom Longline | 2010 | Ongoing | 5/26/10 | Ongoing | Limited to 1,000 hooks of which no more than 750 hooks are rigged for fishing or fished | Gulf of Mexico EEZ | 75 FR 21512 | 622.34 | Reef Fish Amendment 31 |

¹Except when, purchased from a fish processor, filleted carcasses may be used as bait crab and lobster traps.

Quota History

| First Yr In Effect | Last YR In Effect | Effective Date | End Date | Fishery | Species Affected | Quota | ACL | ACT | Units | Region Affected | FR Reference | FR Section | Amendment Number or Rule Type |
|--------------------|-------------------|----------------|----------|---------|---|-------|-----|-----|----------|--------------------|--------------|------------|--------------------------------|
| 1990 | 1991 | 2/21/90 | 12/31/91 | Com | All Groupers Excluding DWG ¹ and Goliath | 9.2 | | | mp ww | Gulf of Mexico EEZ | 55FR 2078 | 641.25 | Reef Fish Amendment 1 |
| 1992 | 2003 | 6/22/92 | 12/31/03 | Com | All Groupers Including Scamp Excluding DWG ¹ and Goliath | 9.8 | | | mp ww | Gulf of Mexico EEZ | 57 FR 21752 | 641.25 | Reef Fish Regulatory Amendment |
| 2004 | 2008 | 7/15/04 | 12/31/08 | Com | All Groupers Including Scamp Excluding DWG ¹ , Goliath, and Nassau | 8.8 | | | mp gw | Gulf of Mexico EEZ | 69 FR 33315 | 622.42 | Secretarial Amendment 1 |
| 2009 | 2009 | 5/18/09 | 12/31/09 | Com | SWG ² | 7.48 | | | mp gw | Gulf of Mexico EEZ | 74 FR 17603 | 622.42 | Reef Fish Amendment 30B |
| 2010 | 2010 | 5/18/09 | 12/31/10 | Com | SWG ² | 0.41 | | | mp gw | Gulf of Mexico EEZ | 74 FR 17603 | 622.42 | Reef Fish Amendment 30B |
| 2011 | 2011 | 11/2/11 | 12/31/11 | Com | SWG ² | 0.41 | | | mp gw | Gulf of Mexico EEZ | 76 FR 67618 | 622.42 | Reef Fish Regulatory Amendment |
| 2012 | 2012 | 3/12/12 | 12/31/12 | Com | SWG ² | 0.509 | | | mp gw | Gulf of Mexico EEZ | 77 FR 6988 | 622.49 | Reef Fish Amendment 32 |
| 2013 | 2013 | 3/12/12 | 12/31/13 | Com | SWG ² | 0.518 | | | mp gw | Gulf of Mexico EEZ | 77 FR 6988 | 622.49 | Reef Fish Amendment 32 |
| 2014 | 2014 | 1/7/15 | 12/31/14 | Com | Other SWG ³ | 0.523 | | | mp gw | Gulf of Mexico EEZ | 79 FR 72556 | 622.39 | Reef Fish Framework Action |
| 2015 | Ongoing | 1/7/15 | Ongoing | Com | Other SWG ³ | 0.525 | | | mp gw | Gulf of Mexico EEZ | 79 FR 72556 | 622.39 | Reef Fish Framework Action |

¹DWG: deep-water grouper (misty grouper, snowy grouper, yellowedge grouper, warsaw grouper)

²SWG: shallow-water grouper (black, gag, red, red hind, rock hind, scamp, yellowfin, and yellowmouth)

³Other SWG: other shallow-water grouper (black grouper, scamp, yellowmouth grouper, yellowfin grouper)

Scamp would be applied to the DWG quota once the SWG quota was filled. DWG were defined as misty grouper, snowy grouper, yellowedge grouper, warsaw grouper, and scamp once the SWG quota was filled.

2.7 Closures in the Gulf of Mexico Due to Meeting Commercial Quota or Commercial/Recreational ACL

2.8 State Regulatory Information

Florida West Coast:

Gulf of Mexico Scamp Regulation History

| <u>Year</u> | <u>Minimum Size Limit</u> | <u>Recreational Daily Harvest Limits</u> | <u>Commercial Daily Harvest Limits</u> | <u>Regulation Changes</u> | <u>Rule Change Effective Date</u> |
|-------------|---------------------------|--|--|---|-----------------------------------|
| 1980 | None | None | None | | |
| 1981 | None | None | None | | |
| 1982 | None | None | None | | |
| 1983 | None | None | None | | |
| 1984 | None | None | None | | |
| 1985 | None | None | None | | |
| 1986 | None | 5 per person per day within the 5-fish grouper aggregate bag limit | None | Established a recreational bag limit. Prohibited use of longline gear by commercial fishermen. Longline harvesters targeting other species have a bycatch allowance of 5%. Prohibited use of stab nets (or sink nets) to take grouper in Atlantic waters of Monroe County. Required fish to be landed in whole condition. | Dec. 11, 1986 |
| 1987 | None | 5 per person per day within the 5-fish grouper aggregate bag limit | None | | |
| 1988 | None | 5 per person per day within the 5-fish grouper aggregate bag limit | None | | |

| | | | | | |
|------|-----------|--|------|---|---------------|
| 1989 | None | 5 per person per day within the 5-fish grouper aggregate bag limit | None | | |
| 1990 | 20 inches | 5 per person per day within the 5-fish grouper aggregate bag limit | None | Established a minimum size limit. Designated all grouper as “restricted species.” Designated allowable gear as hook and line, black sea bass trap, spear, gig, or lance (except powerheads, bangsticks, or explosive devices). Prohibited all commercial harvest in state waters when harvest for that species is prohibited in adjacent federal waters. | Feb. 1, 1990 |
| 1991 | 20 inches | 5 per person per day within the 5-fish grouper aggregate bag limit | None | | |
| 1992 | 20 inches | 5 per person per day within the 5-fish grouper aggregate bag limit | None | Required harvesters possess the appropriate federal permit to exceed the recreational bag limit and to purchase or sell grouper on the Gulf coast. | Dec. 31, 1992 |
| 1993 | 20 inches | 5 per person per day within the 5-fish grouper aggregate bag limit | None | Allowed persons who possess either a Gulf of Mexico or South Atlantic federal reef fish permit to commercially harvest snappers and groupers (except red snapper) in all state waters until July 1, 1995 | Oct. 18, 1993 |
| 1994 | 20 inches | 5 per person per day within the 5-fish grouper aggregate bag limit | None | Allowed a two-day possession limit for reef fish statewide for persons aboard charter and headboats on trips exceeding 24 hours provided the vessel is equipped with a permanent berth for each passenger aboard, | March 1, 1994 |

| | | | | | |
|------|-----------|--|------|--|---------------------------------------|
| | | | | and each passenger has a receipt verifying the trip length. Modified rule language to provide the same definitions of Gulf of Mexico and Atlantic Ocean regions. | |
| 1995 | 20 inches | 5 per person per day within the 5-fish grouper aggregate bag limit | None | Continued the allowance for persons to possess either the proper South Atlantic or Gulf permit to harvest reef fish for commercial purposes through Dec. 31, 1995. | July 1, 1995 |
| 1996 | 20 inches | 5 per person per day within the 5-fish grouper aggregate bag limit | None | (1) Continued the allowance for persons to possess either the proper South Atlantic or Gulf permit to harvest reef fish for commercial purposes through Dec. 31, 1996. (2) Continued the allowance for persons to possess either the proper South Atlantic or Gulf permit to harvest reef fish for commercial purposes through Dec. 31, 1997. | (1) Jan. 1, 1996 (2) Nov. 27, 1996 |
| 1997 | 20 inches | 5 per person per day within the 5-fish grouper aggregate bag limit | None | | |
| 1998 | 20 inches | 5 per person per day within the 5-fish grouper aggregate bag limit | None | | |
| 1999 | 20 inches | 5 per person per day within the 5-fish grouper aggregate bag limit | None | | |
| 2000 | 20 inches | 5 per person per day within the 5-fish grouper | None | Eliminated the 5-day commercial closure extension. | Jan. 1, 2000 |

| | | | | | |
|------|--------------|--|------|---|---------------|
| | | aggregate bag limit | | | |
| 2001 | 20 inches | 5 per person per day within the 5-fish grouper aggregate bag limit | None | | |
| 2002 | 20 inches | 5 per person per day within the 5-fish grouper aggregate bag limit | None | | |
| 2003 | 16 inches TL | 5 per person per day within the 5-fish grouper aggregate bag limit | None | Reduced the minimum size limit. | Jan. 1, 2003 |
| 2004 | 16 inches TL | 5 per person per day within the 5-fish grouper aggregate bag limit | None | Establishes a Sept. 20 through Oct. 4 closure to use of black sea bass traps in all Gulf of Mexico state waters between three and nine miles from shore. | July 15, 2004 |
| 2005 | 16 inches TL | 5 per person per day within the 5-fish grouper aggregate bag limit | None | | May 20, 2005 |
| 2006 | 16 inches TL | 5 per person per day within the 5-fish grouper aggregate bag limit | None | Provided that, for purposes of determining the legal size of reef fish species, "total length" means the straight-line distance from the most forward point of the head with the mouth closed, to the farthest tip of the tail with the tail compressed or squeezed, while the fish is lying on its side. | July 1, 2006 |
| 2007 | 16 inches TL | 5 per person per day within the 5-fish grouper | None | Prohibited commercial fishermen from harvesting or possessing the recreational bag | July 1, 2007 |

| | | | | | |
|------|--------------|--|------|--|---------------|
| | | aggregate bag limit | | limit of reef fish species on commercial trips. | |
| 2008 | 16 inches TL | 5 per person per day within the 5-fish grouper aggregate bag limit | None | Required all commercial and recreational anglers fishing for Gulf reef species are required to use circle hooks, dehooking devices, and venting tools. | June 1, 2008 |
| 2009 | 16 inches TL | 4 fish per person within the 4-fish grouper aggregate bag limit | None | Reduced the recreational bag limit. Established a Feb. 1 – March 31 closed spawning season for all recreational harvest of shallow-water groupers in Gulf state waters, except Monroe County. | Aug. 27, 2009 |
| 2010 | 16 inches TL | 4 fish per person within the 4-fish grouper aggregate bag limit | None | Prohibited the captain and crew of for-hire vessels from retaining any species in the aggregate grouper bag limit. | Jan. 19, 2010 |
| 2011 | 16 inches TL | 4 fish per person within the 4-fish grouper aggregate bag limit | None | | |
| 2012 | 16 inches TL | 4 fish per person within the 4-fish grouper aggregate bag limit | None | | |
| 2013 | 16 inches TL | 4 fish per person within the 4-fish grouper aggregate bag limit | None | Eliminated the Feb. 1 – March 31 closed spawning season for all recreational harvest of shallow-water groupers in Gulf state waters, except Monroe County. | Oct. 31, 2013 |
| 2014 | 16 inches TL | 4 fish per person within the 4-fish grouper aggregate bag limit | None | Eliminated the requirement to possess and use venting tools when fishing for reef fish in the Gulf of Mexico. | Jan. 24, 2014 |

| | | | | | |
|------|--------------|---|------|--|--|
| 2015 | 16 inches TL | 4 fish per person within the 4-fish grouper aggregate bag limit | None | | |
| 2016 | 16 inches TL | 4 fish per person within the 4-fish grouper aggregate bag limit | None | | |
| 2017 | 16 inches TL | 4 fish per person within the 4-fish grouper aggregate bag limit | None | | |
| 2018 | 16 inches TL | 4 fish per person within the 4-fish grouper aggregate bag limit | None | | |
| 2019 | 16 inches TL | 4 fish per person within the 4-fish grouper aggregate bag limit | None | | |

Texas:

Texas does not have state regulations on Scamp. Those fish captured in federal waters will be adhere to federal regulations.

Mississippi:

Mississippi has continually remained compliant with federal regulations for Scamp. These regulations are listed in Title 22 Part 7 of the Mississippi State Code which can be found at: <http://www.dmr.state.ms.us/index.php/dmr-information/regulations>.

Louisiana:

Scamp are currently regulated in Louisiana with as part of the 4 fish grouper aggregate bag limit with a 16 inch minimum total length. There is currently a regulated closed season for scamp from February 1 through March 31 of each year in waters seaward of the 20 fathom boundary.

Brief regulatory history is below.

- 1990 (June) - All groupers have a 5 fish per day (in aggregate) bag limit.
- 2000 (July) – 16 inch total length minimum size established.
- 2007 (July) – Zero bag limit of groupers for captain and crew.
- 2012 (September) – Grouper aggregate reduced to 4 fish per day. Closed season of February 1 through March 31 of each year established for scamp.
- 2014 (June) – Closed season of February 1 through March 31 of each year seaward of the 20 fathom boundary established for scamp.

Alabama:

Scamp are currently regulated in Alabama as part of the 4 fish grouper aggregate bag limit with a 16-inch minimum total length.

Alabama Regulatory history:

- 2002 – December 22 Scamp possession limit regulation begins. Scamp must be minimum 16" total length and a possession limit as part of the 5 fish Grouper Aggregate limit.
- 2009 – July 23 Grouper aggregate limit moved from 5 fish to 4 fish.

3 ASSESSMENT HISTORY AND REVIEW

No formal stock assessments have been conducted for Scamp Grouper in the Gulf of Mexico. Fisheries statistics were summarized by Goodyear (1988a) and included:

- Commercial harvest estimates of “groupers and scamp” from 1972-1986;
- Recreational harvest estimates from 1979-1986;
- Number and weight caught in the Gulf of Mexico headboat fishery in 1986;
- Observed average weights and sampling frequencies from recreational fisheries from 1979- 1986; and

No formal stock assessments have been conducted for Yellowmouth Grouper in the Gulf of Mexico. While Yellowmouth Grouper was a candidate species for assessment during the SEDAR49 Gulf of Mexico Data-Limited Stock Assessment, severe data limitations surrounding misidentification prevented development of any models. Substantial concerns were raised regarding sporadic data inputs and the large possibility of misidentifying Yellowmouth Grouper as Scamp in both landings and derived length composition. The SEDAR49 Assessment Workshop Panel recommended that Yellowmouth Grouper be considered during the Scamp

assessment because Yellowmouth Grouper represents the minority of the combined catches. Fisheries statistics were previously summarized by Goodyear (1988a) and included:

- Commercial harvest estimates of “groupers and scamp” from 1972-1986;
- Recreational harvest estimates from 1979-1986;
- Number and weight caught in the Gulf of Mexico headboat fishery in 1986;
- Observed average weights and sampling frequencies from recreational fisheries from 1979- 1986; and
- Length-frequency sampled from fish traps by TIP from 1984-1986.

References:

Goodyear, C. P. 1988a. The Gulf of Mexico Fishery for Reef Fish Species - A Descriptive Profile. Coastal Resources Division CRD 87/88-19, Southeast Fisheries Center, Miami Laboratory, Coastal Resources Division, Miami, FL. 262 pp.

SEDAR (Southeast Data Assessment and Review). 2016. SEDAR 49 Gulf of Mexico Data-limited Species Stock Assessment Report. SEDAR, North Charleston, SC. 618 pp.

4 REGIONAL MAPS

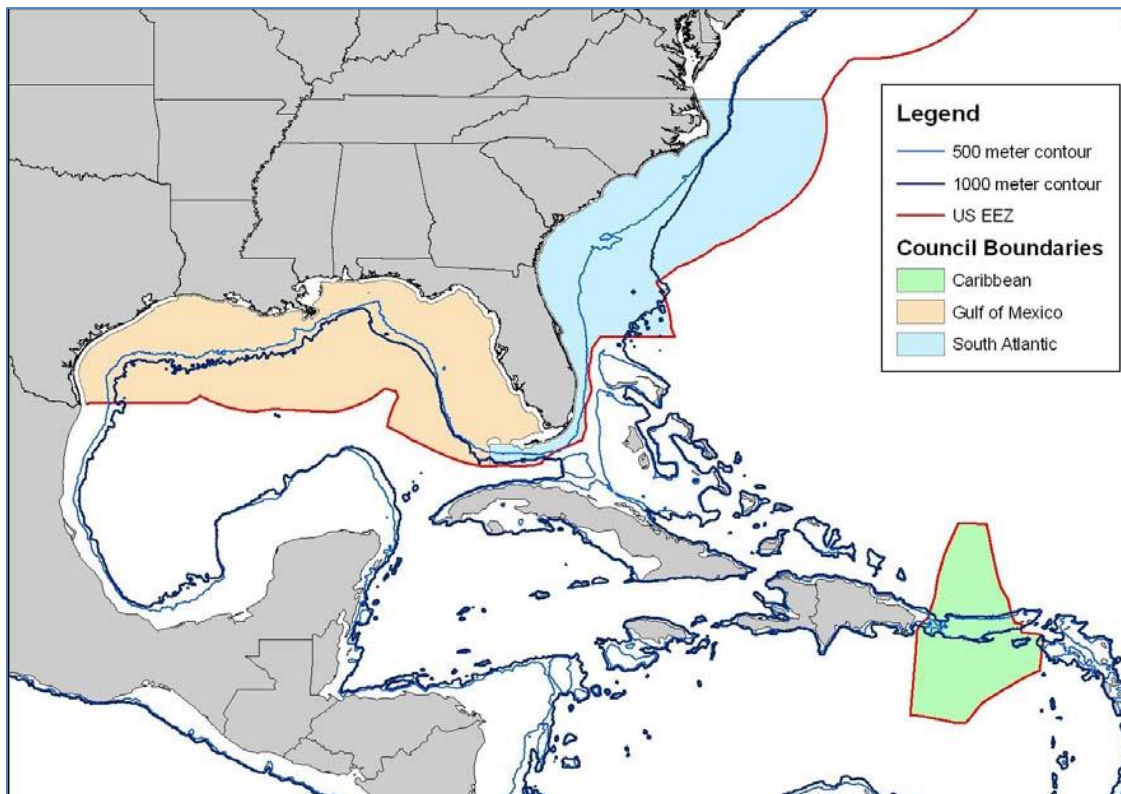

Figure 4.1 Southeast Region including Council and EEZ Boundaries.

5 SEDAR ABBREVIATIONS

| | |
|----------|--|
| ABC | Acceptable Biological Catch |
| ACCSP | Atlantic Coastal Cooperative Statistics Program |
| ADMB | AD Model Builder software program |
| AMRD | Alabama Marine Resources Division |
| ASMFC | Atlantic States Marine Fisheries Commission |
| B | stock biomass level |
| BAM | Beaufort Assessment Model |
| BMSY | value of B capable of producing MSY on a continuing basis |
| CFMC | Caribbean Fishery Management Council |
| CIE | Center for Independent Experts |
| CPUE | catch per unit of effort |
| EEZ | exclusive economic zone |
| F | fishing mortality (instantaneous) |
| FMSY | fishing mortality to produce MSY under equilibrium conditions |
| FOY | fishing mortality rate to produce Optimum Yield under equilibrium |
| FXX% SPR | fishing mortality rate that will result in retaining XX% of the maximum spawning production under equilibrium conditions |
| FMAX | fishing mortality that maximizes the average weight yield per fish recruited to the fishery |
| F0 | a fishing mortality close to, but slightly less than, Fmax |
| FL FWCC | Florida Fish and Wildlife Conservation Commission |
| FWRI | (State of) Florida Fish and Wildlife Research Institute |
| GA DNR | Georgia Department of Natural Resources |
| GLM | general linear model |
| GMFMC | Gulf of Mexico Fishery Management Council |
| GSMFC | Gulf States Marine Fisheries Commission |
| GULF FIN | GSMFC Fisheries Information Network |
| HMS | Highly Migratory Species |
| LDWF | Louisiana Department of Wildlife and Fisheries |

| | |
|--------|---|
| M | natural mortality (instantaneous) |
| MARMAP | Marine Resources Monitoring, Assessment, and Prediction |
| MDMR | Mississippi Department of Marine Resources |
| MFMT | maximum fishing mortality threshold, a value of F above which overfishing is deemed to be occurring |
| MRFSS | Marine Recreational Fisheries Statistics Survey |
| MRIP | Marine Recreational Information Program |
| MSST | minimum stock size threshold, a value of B below which the stock is deemed to be overfished |
| MSY | maximum sustainable yield |
| NC DMF | North Carolina Division of Marine Fisheries |
| NMFS | National Marine Fisheries Service |
| NOAA | National Oceanographic and Atmospheric Administration |
| OY | optimum yield |
| SAFMC | South Atlantic Fishery Management Council |
| SAS | Statistical Analysis Software, SAS Corporation |
| SC DNR | South Carolina Department of Natural Resources |
| SEAMAP | Southeast Area Monitoring and Assessment Program |
| SEDAR | Southeast Data, Assessment and Review |
| SEFIS | Southeast Fishery-Independent Survey |
| SEFSC | Fisheries Southeast Fisheries Science Center, National Marine Fisheries Service |
| SERO | Fisheries Southeast Regional Office, National Marine Fisheries Service |
| SPR | spawning potential ratio, stock biomass relative to an unfished state of the stock |
| SSB | Spawning Stock Biomass |
| SS | Stock Synthesis |
| SSC | Science and Statistics Committee |
| TIP | Trip Incident Program; biological data collection program of the SEFSC and Southeast States. |
| TPWD | Texas Parks and Wildlife Department |
| Z | total mortality, the sum of M and F |



SEDAR

Southeast Data, Assessment, and Review

SEDAR 68

Gulf of Mexico Scamp

SECTION II: Data Workshop Report

December 2020

SEDAR
4055 Faber Place Drive, Suite 201
North Charleston, SC 29405

This information is distributed solely for the purpose of peer review. It does not represent and should not be construed to represent any agency determination or policy.

| | | |
|-------------|---|-----------|
| 1 | INTRODUCTION | 6 |
| 1.1 | WORKSHOP TIME AND PLACE | 6 |
| 1.2 | TERMS OF REFERENCE | 6 |
| 1.3 | LIST OF PARTICIPANTS | 8 |
| 1.4 | LIST OF DATA WORKSHOP WORKING PAPERS & REFERENCE DOCUMENTS | 11 |
| 2 | LIFE HISTORY | 20 |
| 2.1 | OVERVIEW | 20 |
| 2.1.1 | Work Group members and participants in Life History webinars | 20 |
| 2.2 | REVIEW OF WORKING PAPERS RELEVANT TO LIFE HISTORY | 21 |
| 2.3 | AGE AND GROWTH DATA | 25 |
| 2.3.1 | Age calibration among data providers | 26 |
| 2.3.2 | Source of samples | 26 |
| 2.3.3 | Age and length data | 27 |
| 2.3.4 | Modeling Growth | 30 |
| 2.4 | NATURAL MORTALITY | 31 |
| 2.5 | REPRODUCTION | 34 |
| 2.5.1 | Maturity | 34 |
| 2.5.2 | Sexual Transition | 35 |
| 2.5.3 | Sex ratio and mating system | 36 |
| 2.5.4 | Fecundity | 36 |
| 2.5.5 | Measure of reproductive potential | 37 |
| 2.6 | MERISTIC CONVERSIONS | 38 |
| 2.7 | RESEARCH RECOMMENDATIONS | 39 |
| 2.7.1 | Natural Mortality | 39 |
| 2.7.2 | Reproductive Biology | 40 |
| 2.8 | LITERATURE CITED | 41 |
| 2.9 | TABLES | 43 |
| 2.10 | FIGURES | 60 |
| 3 | COMMERCIAL FISHERY STATISTICS | 74 |
| 3.1 | OVERVIEW | 74 |
| 3.1.1 | Commercial Workgroup Participants | 75 |
| 3.1.2 | Issues Discussed at the Data Workshop | 76 |
| 3.2 | REVIEW OF WORKING PAPERS | 76 |
| 3.3 | COMMERCIAL LANDINGS | 76 |

| | | |
|-------------|--|------------|
| 3.3.1 | Commercial Gears | 79 |
| 3.3.2 | Boundaries | 80 |
| 3.3.3 | Scamp/Yellowmouth Groupers Misidentification | 80 |
| 3.3.4 | Unclassified Groupers | 81 |
| 3.3.5 | IFQ Landings | 82 |
| 3.4 | COMMERCIAL DISCARDS | 82 |
| 3.5 | COMMERCIAL EFFORT | 83 |
| 3.6 | BIOLOGICAL SAMPLING | 83 |
| 3.6.1 | Sampling Intensity | 84 |
| 3.6.2 | Length/Age distributions | 84 |
| 3.6.3 | Adequacy for Characterizing Catch | 84 |
| 3.7 | ADEQUACY OF DATA FOR ASSESSMENT ANALYSES | 84 |
| 3.8 | RESEARCH RECOMMENDATIONS | 85 |
| 3.9 | TABLES | 87 |
| 3.10 | FIGURES | 94 |
| 3.11 | APPENDIX A - ALS | 102 |
| 3.12 | APPENDIX B | 105 |
| 4 | RECREATIONAL FISHERY STATISTICS | 108 |
| 4.1 | OVERVIEW | 108 |
| 4.1.1 | Group Membership | 108 |
| 4.1.2 | Tasks | 108 |
| 4.1.3 | Gulf of Mexico Fishery Management Council Scamp Group Management Boundaries | 109 |
| 4.1.4 | Stock ID Recommendations | 109 |
| 4.2 | ABSTRACTS OF WORKING PAPERS | 110 |
| 4.3 | RECREATIONAL DATA SOURCES | 112 |
| 4.3.1 | Marine Recreational Information Program (MRIP) | 112 |
| 4.3.2 | Texas Parks and Wildlife Department's (TPWD) Marine Sport-Harvest Monitoring Program | 115 |
| 4.3.3 | Louisiana Creel Survey (LA Creel) | 116 |
| 4.3.4 | Southeast Region Headboat Survey (SRHS) | 116 |
| 4.3.5 | Headboat At-Sea Observer Survey | 117 |
| 4.4 | RECREATIONAL LANDINGS | 117 |
| 4.4.1 | MRIP Landings | 117 |
| 4.4.2 | TPWD Landings | 118 |
| 4.4.3 | LA Creel Landings | 118 |
| 4.4.4 | SRHS Headboat Logbook Landings | 118 |
| 4.4.5 | Historic Recreational Landings | 119 |
| 4.4.6 | Total Recreational Landings | 120 |
| 4.5 | RECREATIONAL DISCARDS | 120 |

| | | |
|-------------|---|------------|
| 4.5.1 | MRIP Discards | 120 |
| 4.5.2 | LA Creel Discards | 121 |
| 4.5.3 | TPWD Discards | 121 |
| 4.5.4 | Headboat At-Sea Observer Survey Discards | 122 |
| 4.5.5 | SRHS Headboat Logbook Discards | 122 |
| 4.5.6 | Total Recreational Discards | 124 |
| 4.6 | BIOLOGICAL SAMPLING | 124 |
| 4.6.1 | Landings | 125 |
| 4.6.1.1 | MRIP Biological Sampling | 125 |
| 4.6.1.2 | TPWD Biological Sampling | 125 |
| 4.6.1.3 | SRHS Biological Sampling | 126 |
| 4.6.1.4 | Nominal Length Frequency Distributions of Landings | 126 |
| 4.6.1.5 | Aging Data | 127 |
| 4.6.2 | Discards | 127 |
| 4.6.2.1 | Headboat At-Sea Observer Survey Biological Sampling | 127 |
| 4.6.2.2 | Nominal Length Frequency Distributions of Discards | 127 |
| 4.7 | RECREATIONAL EFFORT | 127 |
| 4.7.1 | MRIP Effort | 128 |
| 4.7.2 | TPWD Effort | 128 |
| 4.7.3 | LA Creel Effort | 128 |
| 4.7.4 | SRHS Effort | 128 |
| 4.7.5 | Total Recreational Fishing Effort | 129 |
| 4.8 | COMMENTS ON ADEQUACY OF DATA FOR ASSESSMENT ANALYSES | 129 |
| 4.9 | Itemized List of Tasks for Completion following Workshop | 130 |
| 4.10 | RESEARCH RECOMMENDATIONS | 130 |
| 4.10.1 | Research Recommendations for SEDAR 68 | 130 |
| 4.11 | Literature Cited | 130 |
| 4.12 | TABLES | 133 |
| 4.13 | FIGURES | 144 |
| 5 | INDICES OF POPULATION ABUNDANCE | 152 |
| 5.1 | OVERVIEW | 152 |
| 5.1.1 | Group membership | 153 |
| 5.2 | REVIEW OF WORKING PAPERS | 153 |
| 5.3 | FISHERY-INDEPENDENT INDICES | 153 |
| 5.3.1 | Combined stereo-video index | 153 |
| 5.4 | FISHERY-DEPENDENT INDICES | 157 |
| 5.4.1 | Recreational Headboat Index | 157 |
| 5.4.2 | Coastal Fisheries Logbook Program | 160 |
| 5.4.3 | Commercial Vertical Line | 162 |
| 5.4.4 | Commercial Longline | 168 |

| | | |
|------------|---|------------|
| 5.4.5 | Reef Fish Observer Program | 173 |
| 5.5 | OTHER DATA SOURCES CONSIDERED DURING THE DW | 176 |
| 5.6 | CONSENSUS RECOMMENDATIONS AND SURVEY EVALUATIONS | 176 |
| 5.7 | LITERATURE CITED | 177 |
| 5.8 | Tables | 178 |
| 5.8 | FIGURES | 189 |
| 6 | DISCARD MORTALITY AD-HOC WORKING GROUP | 196 |
| 6.1 | LITERATURE CITED | 199 |
| 6.2 | TABLES | 201 |

1 INTRODUCTION

1.1 WORKSHOP TIME AND PLACE

The SEDAR 68 Data Workshop was scheduled to be held March 16-20, 2020 in Charleston, SC. Due to rising concerns regarding the COVID-19 pandemic, the in-person workshop was cancelled, and a modified process was developed.

- SEDAR 68 Scamp Data Review and Recommendation Process: After the cancellation of the in-person DW, and the mounting evidence that it would be some time before any sort of large gathering would be possible, SEDAR and SEFSC Staff held discussions to determine a path forward, followed by additional discussions with the previously appointed working group leads. The following process is currently underway:
 - Working Groups (Life History, Commercial Statistics, Recreational Statistics, and Indices of Abundance) worked amongst themselves to schedule and held various meetings to review the available data and make pre-decisional recommendations.
 - Several publicly noticed Data Plenary webinars will be held, during which the Working Groups will present the results of the discussions to the entire Data Panel for review and comment.
 - If concerns are raised that require additional analysis, the Working Group will be tasked to complete that request and report back at the next Plenary webinar.
 - Once the Panel is satisfied with the analyses, then the Assessment Development Team (ADT) will make the final decision regarding recommending using the data in the assessment. These recommendations will happen during the Plenary webinars.
 - A Data Process Report will be produced, to document the discussions and decisions of the Panel and the ADT.

1.2 TERMS OF REFERENCE

1. Definition of assessment unit stock will be developed through the Scamp Stock ID process and will be added to TORs once process is complete.
2. Review, discuss, and tabulate available life history information for each stock being assessed.
 - Evaluate age, growth, natural mortality, and reproductive characteristics
 - Explore the validity of age data and methodology across ageing facilities
 - Provide appropriate models to describe population and fleet specific (if warranted) growth, maturation, hermaphroditism including age and size at transition, and fecundity by age, sex, or length as applicable.
 - Evaluate the adequacy of available life history information for conducting stock assessments and recommend life history information for use in population modeling.
 - Evaluate and discuss the sources of uncertainty and error, and data limitations (such as temporal and spatial coverage) for each data source. Provide estimates or ranges of uncertainty for all life history information.
3. Provide measures of population abundance that are appropriate for stock assessment.
 - Consider all available and relevant fishery-dependent and -independent data sources

- Document all programs evaluated; address program objectives, methods, coverage, sampling intensity, and other relevant characteristics.
 - Provide maps of fishery and independent survey coverage.
 - Develop fishery and survey CPUE indices by appropriate strata (e.g., age, size, area, and fishery) and include measures of precision and accuracy.
 - Document pros and cons of available indices regarding their ability to represent abundance.
 - Consider potential species identification issues between scamp and yellowmouth grouper and, if present, whether the issue was adequately addressed during index development.
 - Categorize the available indices into one of three tiers: Suitable and Recommended, Suitable and Not Recommended, or Not Suitable; *provide justifications for the categorization.*
 - For recommended indices, document any known or suspected temporal patterns in catchability not accounted for by standardization.
 - Provide appropriate measures of uncertainty for the abundance indices to be used in stock assessment models.
4. Provide commercial catch statistics for each stock being assessed, including both landings and discards in both pounds and number. Consider species identification issues between scamp and yellowmouth grouper and correct for these instances as appropriate.
- Evaluate and discuss the adequacy of available data for accurately characterizing landings and discards by fishery sector or gear.
 - Provide length and age distributions for both landings and discards if feasible.
 - Provide maps of fishery effort and harvest by fishery sector or gear.
 - Provide estimates of uncertainty around each set of landings and discard estimates.
5. Provide recreational catch statistics for each stock being assessed, including both landings and discards in both pounds and number. Consider species identification issues between scamp and yellowmouth grouper and correct for these instances as appropriate.
- Evaluate and discuss the adequacy of available data for accurately characterizing landings and discards by fishery sector or gear.
 - Provide length and age distributions for both landings and discards if feasible.
 - Provide maps of fishery effort and harvest by fishery sector or gear.
 - Provide estimates of uncertainty around each set of landings and discard estimates.
6. Recommend discard mortality rates.
- Review available research and published literature.
 - Consider research directed at scamp as well as similar species from the southeastern United States and other areas.
 - Provide estimates of discard mortality rate by fishery, gear type, depth, and other feasible or appropriate strata.
 - Provide estimates of uncertainty around recommended discard mortality rates
 - Document the rationale for recommended rates and uncertainties.

7. Describe any known evidence regarding ecosystem, climate, species interactions, habitat considerations, and/or episodic events (*including red tide and upwelling events*) that would reasonably be expected to affect scamp population dynamics, *and the effectiveness of biological reference points* that might ensue.
 - Review available predation studies and summarize diet composition with respect to ontogeny, seasonality, and habitat, where available.
 - Provide species envelopes, i.e. minimum and maximum values of environmental boundaries (e.g. depth, temperature, substrate, relief) based on observations of occurrence.
 - Use available survey datasets to determine species that frequently co-occur or are associated with scamp.
 - Develop hypotheses to link the ecosystem and climatic events identified in addressing this TOR to population and fishery parameters that can be evaluated and modeled.

8. Provide recommendations for future research in areas such as sampling, fishery monitoring, and stock assessment. Include specific guidance on sampling intensity (number of samples including age and length structures) and appropriate strata and coverage.

9. Prepare a Data Workshop report providing complete documentation of workshop actions and decisions in accordance with project schedule deadlines.

1.3 LIST OF PARTICIPANTS

Assessment Development Team

| | |
|---|-------------------------|
| Francesca Forrestal, Co-Lead Analyst..... | NMFS Miami |
| Skyler Sagarese, Co-Lead Analyst | NMFS Miami |
| Churchill Grimes..... | SAFMC SSC |
| Will Patterson..... | GMFMC SSC/UFL |
| Sean Powers | GMFMC SSC/South Alabama |
| Marcel Reichert..... | SCDNR |
| Alexei Sharov..... | SAFMC SSC/MD DNR |
| Kyle Shertzer | NMFS Beaufort |
| Jim Tolan | GMFMC SSC/TPWD |

Data Process Participants

| | |
|-----------------------|------------------|
| Nate Bacheler..... | NMFS Beaufort |
| Beverly Barnett | NMFS Panama City |
| Veronica Beech..... | NMFS Panama City |
| Alan Bianchi | NC DMF |
| Ken Brennan | NMFS Beaufort |
| Steve Brown..... | FWRI, Cedar Key |
| Wally Bubleby | MARMAP/SCDNR |
| Julia Byrd..... | SAFMC Staff |
| Matt Campbell | NMFS Pascagoula |
| Andrew Cathey | NC DENR |
| Rob Cheshire..... | NMFS Beaufort |

| | |
|-----------------------------|------------------|
| Judd Curtis | GMFMF SSC/TAMUCC |
| Amy Dukes | SCDNR |
| Eric Fitzpatrick..... | NMFS Beaufort |
| Kelly Fitzpatrick | NMFS Beaufort |
| Claudia Friess..... | FL FWC |
| Keilin Gamboa-Salazar | SCDNR |
| Chris Gardner | NMFS Panama City |
| Jimmy Hull..... | Industry Rep |
| Deidera Jeffcoat | Industry Rep |
| Mandy Karnauskas..... | NMFS Miami |
| Nikolai Klibansky | NMFS Beaufort |
| Dominque Lazare..... | FWC St. Pete |
| Robert Leaf | USM |
| Sue Lowerre-Barbieri..... | FL FWC |
| Carole Neidig..... | Mote Marine Lab |
| Matt Nuttall | NMFS Miami |
| Vivian Matter | NMFS Miami |
| Stephanie Martinez | NMFS Miami |
| Kevin McCarthy..... | NMFS Miami |
| Randy McKinley..... | Industry Rep |
| Refik Orhun | NMFS Miami |
| Andy Ostroski..... | NMFS Beaufort |
| Kate Overly | NMFS Panama City |
| Jennifer Potts..... | NMFS Beaufort |
| Jeff Pulver | NMFS SERO |
| Mike Rinaldi | ACCSP |
| Brendan Runde..... | NCSU |
| Beverly Sauls | FWC St. Pete |
| Katie Siegfried | NMFS Miami |
| Julie Deflippi Simpson..... | ACCSP |
| Tracey Smart | MARMAP/SCDNR |
| Tom Sminkey | NMFS |
| Steve Smith | NMFS Miami |
| Molly Stevens | NMFS Miami |
| Ted Switzer | FL FWC |
| Kevin Thompson..... | FL FWC |
| Laura Thornton | NMFS Panama City |
| Dave Wynski..... | SCDNR |
| Beth Wrege | NMFS Miami |

Council Representation

| | |
|-------------------|-------|
| Tim Griner | SAFMC |
| Paul Mickle | GMFMC |

Staff

| | |
|------------------|-------|
| Julie Neer | SEDAR |
|------------------|-------|

Mike Errigo SAFMC Staff
 Kathleen Howington SEDAR
 Ryan Rindone..... GMFMC Staff

Additional Observers

Rob Ahrens SAFMC SSC/UFL
 Sarina Atkinson..... NMFS Miami
 Larry Beerkircher NMFS Miami
 Gregg Bray GSMFC
 Myra Brouwer SAFMC Staff
 Catherine Bruger Ocean Conservancy
 Jeff Buckel SAFMC SSCNCSU
 Dave Chagaris GMFMC SSCUFL
 Chip Collier..... SAFMC Staff
 Tanya Darden..... SCDNR
 Michael Drexler Ocean Conservancy
 Guillermo Diaz..... NMFS Miami
 Margaret Finch..... SCDNR
 Francesca Forrestal NMFS Miami
 Dawn Franco GADNR
 Dawn Glasgow SCDNR
 Homer Hiers..... SCDNR
 Allie Iberle SAFMC Staff
 Jeff Isely..... NMFS Miami
 Max Lee Mote Marine Lab
 Stephen Long SCDNR
 Alan Lowther NMFS Miami
 Michelle Masi NMFS Galveston
 Adyan Rios..... NMFS Miami
 Daniel RobertsWater Interface
 Kayla Rudnay..... SCDNR
 George Sedberry SAFMC SSC
 Allison Shideler NMFS Miami
 Wiley Sinkus SCDNR
 Matt Smith NMFS Miami
 McLean Stewart NCDENR
 Brendan Turley NMFS
 Michelle Willis..... MARMAP/SCDNR

1.4 LIST OF DATA WORKSHOP WORKING PAPERS & REFERENCE DOCUMENTS

| Document # | Title | Authors | Date Submitted |
|--|--|--|--|
| Documents Prepared for the Stock ID Process | | | |
| SEDAR68-SID-01 | Brief Summary of FWRI-FDM Tag-Recapture Program | Rachel Germeroth | 8 April 2019 Updated: 3 September 2019 |
| SEDAR68-SID-02 | Larval dispersal of scamp (<i>Mycteroperca phenax</i>) in the waters off the southeastern United States: Connectivity within and between the Gulf of Mexico and Atlantic Ocean | J. R. Brothers, M. Karnauskas, C.B. Paris, and K.W. Shertzer | 28 September 2019 |
| SEDAR68-SID-03 | Preliminary Genetic Stock Assessment of Scamp (<i>Mycteroperca phenax</i>) in Florida Waters | Elizabeth Wallace | 26 July 2019 Updated: 20 September 2019 |
| SEDAR68-SID-04 | Population Genetic Analyses of Scamp | Darden, T. and M. Walker | 26 July 2019 Updated: 22 August 2019 |
| SEDAR68-SID-05 | Gulf of Mexico and Atlantic Scamp Stock ID Process Final Report | Stock ID Panel | 31 March 2020 |
| | | | |
| Documents Prepared for the Data Workshop | | | |
| SEDAR68-DW-01 | Standardized video counts of Southeast U.S. Atlantic scamp and yellowmouth grouper (<i>Mycteroperca phenax</i> and <i>Mycteroperca interstitialis</i>) from the Southeast Reef Fish Survey | Rob Cheshire and Nathan Bacheler | 7 February 2020 |
| SEDAR68-DW-02 | Standardized catch rates of scamp and yellowmouth grouper (<i>Mycteroperca phenax</i> and <i>Mycteroperca interstitialis</i>) in the southeast U.S. from headboat logbook data | Sustainable Fisheries Branch | 4 March 2020 |
| SEDAR68-DW-03 | Standardized catch rates of scamp and yellowmouth grouper (<i>Mycteroperca phenax</i> and <i>Mycteroperca interstitialis</i>) in the | Sustainable Fisheries Branch | 2 March 2020 Updated: 9 March 2020; |

| | | | |
|---------------|--|--|---|
| | southeast U.S. from commercial logbook data | | 13 April 2020 |
| SEDAR68-DW-04 | Scamp/Yellowmouth Grouper Fishery-Independent Indices of Abundance in US South Atlantic Waters Based on a Chevron Video Trap Survey and a Short Bottom Longline Survey | Walter J. Bubley, Dawn Glasgow, and Tracey I. Smart | 20 February 2020 |
| SEDAR68-DW-05 | Reproductive Parameters for South Atlantic Scamp and Yellowmouth Grouper in Support of the SEDAR 68 Research Track Assessment | David M. Wyanski, Dawn M. Glasgow, Keilin R. Gamboa-Salazar, and Wally J. Bubley | 4 March 2020 Updated: 31 October 2020 |
| SEDAR68-DW-06 | Fisheries-independent data for Scamp (<i>Mycteroperca phenax</i>) from reef-fish visual surveys in the Florida Keys and Dry Tortugas, 1999-2018 | Jessica Keller, Jennifer Herbig, and Alejandro Acosta | 19 February 2020 |
| SEDAR68-DW-07 | Indices of abundance for Scamp (<i>Mycteroperca phenax</i>) using combined data from three independent video surveys | Kevin A. Thompson, Theodore S. Switzer, Mary C. Christman, Sean F. Keenan, Christopher Gardner, Katherine E. Overly, Matt Campbell | 19 February 2020 Updated: 21 October 2020 |
| SEDAR68-DW-08 | Recreational Survey data for Scamp and Yellowmouth Grouper in the South Atlantic | Vivian M. Matter and Matthew A. Nuttall | 2 March 2020 Updated: 11 March 2020 Updated: 25 August 2020 Updated: 27 October 2020 |
| SEDAR68-DW-09 | Recreational Survey data for Scamp and Yellowmouth Grouper in the Gulf of Mexico | Vivian M. Matter and Matthew A. Nuttall | 2 March 2020 Updated: 11 March 2020 Updated: 25 August 2020 |

| | | | |
|---------------|--|--|--|
| | | | Updated: 27 October 2020 |
| SEDAR68-DW-10 | SEFSC computation of variance estimates for custom data aggregations from the Marine Recreational Information Program | Kyle Dettloff, Vivian M. Matter, and Matthew Nuttall | 11 March 2020 |
| SEDAR68-DW-11 | Estimates of Historic Recreational Landings of Scamp and Yellowmouth Grouper in the South Atlantic Using the FHWAR Census Method | Ken Brennan | 25 February 2020 Updated: 29 May 2020 |
| SEDAR68-DW-12 | Estimates of Historic Recreational Landings of Scamp and Yellowmouth Grouper in the Gulf of Mexico Using the FHWAR Census Method | Ken Brennan | 25 February 2020 Updated: 29 May 2020 |
| SEDAR68-DW-13 | Marine Recreational Information Program Metadata for the Atlantic, Gulf of Mexico, and Caribbean regions | Vivian M. Matter and Matthew A. Nuttall | 2 March 2020 |
| SEDAR68-DW-14 | SEAMAP Reef Fish Video Survey: Relative Indices of Abundance of Scamp | Matthew D. Campbell, Kevin R. Rademacher, Paul Felts, Brandi Noble, Joseph Salisbury, and John Moser | 20 February 2020 |
| SEDAR68-DW-15 | Scamp (<i>Mycteroperca phenax</i>) age comparisons between aging labs in the Gulf of Mexico and South Atlantic | Andrew D. Ostrowski, Jennifer C. Potts, and Eric Fitzpatrick | 31 March 2020 |
| SEDAR68-DW-16 | Commercial Discard Length Composition for South Atlantic Scamp and Yellowmouth Grouper | Sarina F. Atkinson | 5 March 2020 Updated: 27 August 2020 |
| SEDAR68-DW-17 | Commercial Discard Length Composition for Gulf of Mexico Scamp and Yellowmouth Grouper | Sarina F. Atkinson | 5 March 2020 Updated: 27 August 2020 |
| SEDAR68-DW-18 | Standardized Catch Rate Indices for Scamp (<i>Mycteroperca phenax</i>) and Yellowmouth Grouper | Gulf and Caribbean Branch | 2 March 2020 |

| | | | |
|---------------|---|--|---|
| | (<i>Mycteroperca interstitialis</i>) during 1986-2017 by the U.S. Gulf of Mexico Headboat Recreational Fishery | | Updated: 9 June 2020 Updated: 10 December 2020 |
| SEDAR68-DW-19 | Scamp grouper reproduction on the West Florida Shelf | Susan Lowerre-Barbieri, Hayden Menendez, Ted Switzer, and Claudia Friess | 4 March 2020 Updated: 2 April 2020 |
| SEDAR68-DW-20 | Summary of preliminary age, length, and reproduction data for U.S. Gulf of Mexico scamp, <i>Mycteroperca phenax</i> , submitted for SEDAR68 | Veronica Beech, Laura Thornton, Beverly Barnett | 3 March 2020 |
| SEDAR68-DW-21 | Summary of preliminary age and length data for U.S. Gulf of Mexico yellowmouth grouper, <i>Mycteroperca interstitialis</i> , submitted for SEDAR68 | Laura Thornton, Veronica Beech, Beverly Barnett | 3 March 2020 |
| SEDAR68-DW-22 | Preliminary Non-Technical Fishery Profile and Limited Data Summary for Scamp, <i>Mycteroperca phenax</i> with Focus on the West Florida Shelf: Application of Electronic Monitoring on Commercial Snapper Grouper Bottom Longline Vessels | Carole L. Neidig, Daniel Roberts, Max Lee, Ryan Schloesser | 12 March 2020 |
| SEDAR68-DW-23 | Scamp Length Frequency Distributions from At-Sea Headboat Surveys in the South Atlantic, 2005 to 2017 | Dominique Lazarre, Chris Wilson, Kelly Fitzpatrick | 1 April 2020 |
| SEDAR68-DW-24 | A Summary of Observer Data from the Size Distribution and Release Condition of Scamp Discards from Recreational Fishery Surveys in the Eastern Gulf of Mexico | Dominique Lazarre | 1 April 2020 |
| SEDAR68-DW-25 | Summary of the SAFMC Scamp Release Citizen Science Pilot Project for SEDAR 68 | Julia Byrd | 16 April 2020 Updated: 26 August 2020 |
| SEDAR68-DW-26 | Voluntary reports of Scamp caught by private recreational anglers in MyFishCount for SEDAR 68 | Chip Collier | 7 April 2020 |

| | | | |
|---------------|--|--|--|
| SEDAR68-DW-27 | Assigning fates in telemetry studies using hidden Markov models: an application to deepwater groupers released with descender devices | Brendan J. Runde, Theo Michelot, Nathan M. Bacheler, Kyle W. Shertzer, and Jeffrey A. Buckel | 27 February 2020 |
| SEDAR68-DW-28 | Scamp grouper reproduction in the Gulf of Mexico | Susan Lowerre-Barbieri, Veronica Beech, and Claudia Friess | 22 May 2020 Updated: 2 September 2020 |
| SEDAR68-DW-29 | Standardized Catch Rate Indices for Scamp (<i>Mycteroperca phenax</i>) and Yellowmouth Grouper (<i>Mycteroperca interstitialis</i>) during 1993-2017 by the U.S. Gulf of Mexico Vertical Line and Longline Fisheries | Gulf and Caribbean Branch, SFD | 11 September 2020 |
| SEDAR68-DW-30 | CPUE Expansion Estimation for Commercial Discards of Gulf of Mexico Scamp & Yellowmouth Grouper | Steven G. Smith, Kevin J. McCarthy, Stephanie Martinez | 23 September 2020 |
| SEDAR68-DW-31 | SEFSC Computation of Uncertainty for Southeast Regional Headboat Survey and Total Recreational Landings Estimates, with Applications to SEDAR 68 Scamp and Yellowmouth Grouper | Matthew A Nuttall, Kyle Dettloff, Kelly E Fitzpatrick, Kenneth Brennan, and Vivian M Matter | 27 October 2020 |
| SEDAR68-DW-32 | Discards of scamp (<i>Rhomboplites aurorubens</i>) for the headboat fishery in the US South Atlantic | Fisheries Ecosystems Branch, National Marine Fisheries Service, Southeast Fisheries Science Center, Beaufort, NC | 30 October 2020 |
| SEDAR68-DW-33 | Discards of scamp (<i>Mycteroperca phenax</i>) for the headboat fishery in the US Gulf of Mexico | Fisheries Ecosystems Branch, National Marine Fisheries Service, Southeast Fisheries Science | 30 October 2020 |

| | | | |
|----------------------------|--|---|------------------|
| | | Center, Beaufort, NC | |
| SEDAR68-DW-34 | South Atlantic U.S. scamp (<i>Mycteroperca phenax</i>) age and length composition from the recreational fisheries | Fisheries Ecosystems Branch, National Marine Fisheries Service, Southeast Fisheries Science Center | 10 December 2020 |
| SEDAR68-DW-35 | Commercial age and length composition weighting for Southeast U.S. scamp and yellowmouth grouper (<i>Mycteroperca phenax</i> and <i>Mycteroperca interstitialis</i>) | Sustainable Fisheries Branch, National Marine Fisheries Service, Southeast Fisheries Science Center | 12 November 2020 |
| Reference Documents | | | |
| SEDAR68-RD01 | A retrospective (1979-1996) multispecies assessment of coral reef fish stocks in the Florida Keys | Ault et al. 1997 | |
| SEDAR68-RD02 | Spawning Locations for Atlantic Reef Fishes off the Southeastern U.S. | Sedberry et al. 2006 | |
| SEDAR68-RD03 | Site Fidelity and Movement of Reef Fishes Tagged at Unreported Artificial Reef Sites off NW Florida | Addis et al. 2007 | |
| SEDAR68-RD04 | Implications of reef fish movement from unreported artificial reef sites in the northern Gulf of Mexico | Addis et al. 2013 | |
| SEDAR68-RD05 | Comparison of scamp grouper (<i>Mycteroperca phenax</i>), growth off of the West Florida shelf and the coast of Louisiana | Bates 2008 | |
| SEDAR68-RD06 | Aspects Of The Life History Of The Yellowmouth Grouper, <i>Mycteroperca interstitialis</i> , In The Eastern Gulf Of Mexico | Bullock and Murphy, 1994 | |
| SEDAR68-RD07 | Memoirs of the Hourglass Cruises: Seabasses (Pisces: Serranidae) | Bullock and Smith, 1991 | |
| SEDAR68-RD08 | Groupers on the Edge: Shelf Spawning Habitat in and Around | Coleman et al. 2014 | |

| | | |
|--------------|---|------------------------------|
| | Marine Reserves of the Northeastern Gulf of Mexico | |
| SEDAR68-RD09 | Decadal fluctuations in life history parameters of scamp (<i>Mycteroperca phenax</i>) collected by commercial hand-line vessels from the west coast of Florida | Lombardi-Carlson et al. |
| SEDAR68-RD10 | A Description of Age, Growth, and Reproductive Life History Traits of Scamps from the Northern Gulf of Mexico | Lombardi-Carlson et al. 2012 |
| SEDAR68-RD11 | Incorporating Mortality from Catch and Release into Yield-per-Recruit Analyses of Minimum-Size Limits | Waters and Huntsman 1986 |
| SEDAR68-RD12 | Population genetic analysis of red grouper, <i>Epinephelus morio</i> , and scamp, <i>Mycteroperca phenax</i> , from the southeastern U.S. Atlantic and Gulf of Mexico | Zatcoff et al. 2004 |
| SEDAR68-RD13 | Population Assessment of the Scamp, <i>Mycteroperca phenax</i> , from the Southeastern United States | Mancooch et al. 1998 |
| SEDAR68-RD14 | A Preliminary Assessment of the Populations of Seven Species of Grouper (Serranidae, Epinephelinae) in the Western Atlantic Ocean from Cape Hatteras, North Carolina to the Dry Tortugas, Florida | Huntsman et al. |
| SEDAR68-RD15 | Color Variation And Associated Behavior In The Epinepheline Groupers, <i>Mycteroperca microlepis</i> (Goode And Bean) And <i>M. Phenax</i> Jordan And Swain | Gilmore and Jones 1992 |
| SEDAR68-RD16 | Age, Growth, and Reproduction of Scamp, <i>Mycteroperca phenax</i> , in the Southwestern North Atlantic, 1979 – 1997 | Harris et al. 2002 |
| SEDAR68-RD17 | Age, Growth, Mortality, Food and Reproduction of the Scamp, <i>Mycteroperca phenax</i> , Collected off North Carolina and South Carolina | Matheson et al. 1986 |
| SEDAR68-RD18 | Tagging Studies and Diver Observations of Fish Populations on | Parker 1990 |

| | | |
|--------------|--|---|
| | Live-Bottom Reefs of the U.S. Southeastern Coast | |
| SEDAR68-RD19 | Age and growth of the yellowedge grouper, <i>Epinephelus flavolimbatus</i> , and the yellowmouth grouper, <i>Mycteroperca interstitialis</i> , off Trinidad and Tobago | Manickchand-Heileman and Phillip 2000 |
| SEDAR68-RD20 | Multi-decadal decline in reef fish abundance and species richness in the southeast USA assessed by standardized trap catches | Bachelor and Smart 2016 |
| SEDAR68-RD21 | Aspects Of The Life History Of The Yellowmouth Grouper, <i>Mycteroperca interstitialis</i> , In The Eastern Gulf Of Mexico | Bullock and Murphy 1994 |
| SEDAR68-RD22 | Age, Growth, and Mortality of Yellowmouth Grouper from the Southeastern United States | Burton et al. 2014 |
| SEDAR68-RD23 | South Carolina Marine Game Fish Tagging Program 1978 -2009 | Robert K. Wiggers |
| SEDAR68-RD24 | Decadal-scale decline of scamp (<i>Mycteroperca phenax</i>) abundance along the southeast United States Atlantic coast | Nathan M. Bachelor and Joseph C. Ballenger |
| SEDAR68-RD25 | Timing and locations of reef fish spawning off the southeastern United States | Nicholas A. Farmer, William D. Heyman, Mandy Karnauskas, Shinichi Kobara, Tracey I. Smart, Joseph C. Ballenger, Marcel J. M. Reichert, David M. Wyanski, Michelle S. Tishler, Kenyon C. Lindeman, Susan K. Lowerre-Barbieri, Theodore S. Switzer, Justin J. Solomon, Kyle McCain, Mark Marhefka, George R. Sedberry |
| SEDAR68-RD26 | Developmental patterns within a multispecies reef fishery: management applications for essential fish habitats and protected areas | Kenyon C. Lindeman, Roger Pugliese, Gregg T. Waugh, and Jerald S. Ault |
| SEDAR68-RD27 | Ingress of postlarval gag, <i>Mycteroperca microlepis</i> (Pisces: Serranidae) | Paula Keener, G. David Johnson, Bruce W Stender, Edward B. Brothers and Howard R. Beatty |

| | | |
|--------------|---|---|
| SEDAR68-RD28 | Survival estimates for demersal reef fishes released by anglers | Mark R. Collins |
| SEDAR68-RD29 | Commercial catch composition with discard and immediate release mortality proportions off the southeastern coast of the United States | Jessica A. Stephen, Patrick J. Harris |
| SEDAR68-RD30 | Discard composition and release fate in the snapper and grouper commercial hook-and-line fishery in North Carolina, USA | P.J. Rudershausen, J.A. Buckel, and E.H. Williams |
| SEDAR68-RD31 | Sink or swim? Factors affecting immediate discard mortality for the Gulf of Mexico commercial reef fish fishery | J.R. Pulver |
| SEDAR68-RD32 | SEDAR 33-DW-19: A meta-data analysis of discard mortality estimates for gag grouper and greater amberjack | Linda Lombardi, Matthew D. Campbell, Beverly Sauls, and Kevin J. McCarthy |
| SEDAR68-RD33 | Potential survival of released groupers caught deeper than 40 m based on shipboard and in-situ observations, and tag-recapture data | Raymond R. Wilson, Jr. and Karen M. Burns |
| SEDAR68-RD34 | Scamp Fishery Performance Report | SAFMC Snapper Grouper Advisory Panel |
| SEDAR68-RD35 | Hierarchical analysis of multiple noisy abundance indices | Paul B. Conn |
| SEDAR68-RD36 | SAFMC SSC MRIP Workshop Report | SAFMC SSC |
| SEDAR68-RD37 | Catch Characterization and Discards within the Snapper Grouper Vertical Hook-and-Line Fishery | Gulf and South Atlantic Fisheries Foundation |
| SEDAR68-RD38 | A Continuation of Catch Characterization and Discards within the Snapper Grouper Vertical Hook-and-Line Fishery | Gulf and South Atlantic Fisheries Foundation |
| SEDAR68-RD39 | Continuation of Catch Characterization and Discards within the Snapper Grouper Vertical Hook-and-Line Fishery | Gulf and South Atlantic Fisheries Foundation |

| | | |
|--------------|--|--|
| SEDAR68-RD40 | Descender Devices are Promising Tools for Increasing Survival in Deepwater Groupers | Brendan J. Runde and Jeffrey A. Buckel |
| SEDAR68-RD41 | Something's Fishy with Scamp Response Summary | GMFMC |
| SEDAR68-RD42 | Application of three-dimensional acoustic telemetry to assess the effects of rapid recompression on reef fish discard mortality | Erin Collings Bohaboy, Tristan L. Guttridge, Neil Hammerschlag, Maurits P. M. Van Zinnicq Bergmann, and William F. Patterson III |
| SEDAR68-RD43 | Length selectivity of commercial fish traps assessed from in situ comparisons with stereo-video: Is there evidence of sampling bias? | Tim J. Langlois, Stephen J. Newman, Mike Cappel, Euan S. Harvey, Ben M. Rome, Craig L. Skepper, Corey B. Wakefield |
| SEDAR68-RD44 | Changes in Reef Fish Community Structure Following the Deepwater Horizon Oil Spill | Justin P. Lewis, Joseph H. Tarnecki, Steven B. Garner, David D. Chagaris & William F. Patterson III |

2 LIFE HISTORY

2.1 OVERVIEW

The Life History Work Group (LHG) was tasked with reviewing all Life history data for Scamp/Yellowmouth Grouper stocks in the U.S. South Atlantic and Gulf of Mexico and providing parameter inputs for the assessment models as appropriate. The LHG evaluated age, growth, and reproductive characteristics for each stock, including age data that could be used to characterize fishery landings, population growth models, maturity schedules, age and size at sexual transition and estimates of fecundity or other measures of reproductive potential. These data were used to inform estimates of natural mortality. The LHG has provided estimates or ranges of uncertainty for all input data parameters.

2.1.1 Work Group members and participants in Life History webinars

| | | |
|-----------------|----------------------------------|-------|
| Andy Ostrowski | Work Group Co-Lead | NMFS |
| Jennifer Potts | Work Group Co-Lead | NMFS |
| Beverly Barnett | Work Group Deputy | NMFS |
| Laura Thornton | Work Group Deputy and Rapporteur | NMFS |
| Molly Stevens | Work Group member and Rapporteur | NMFS |
| Gregg Bray | Work Group member, Data Provider | GSMFC |
| Veronica Beech | Work Group member, Data Provider | NMFS |

| | | |
|----------------------|----------------------------------|------------------------|
| Wally Bubleby | Work Group member, Data Provider | SCDNR |
| Dave Wyanski | Work Group member, Data Provider | SCDNR |
| Claudia Friess | Work Group member, Data Provider | Florida FWC |
| Nikolai Klibansky | Work Group member | NMFS |
| Sue Lowerre-Barbieri | Work Group member, Data Provider | Florida FWC |
| Kyle Shertzer | Lead Analyst*/ADT | NMFS |
| Skyler Sagarese | Lead Analyst/ADT | NMFS |
| Kate Siegfried | Work Group member/Lead Analyst* | NMFS |
| Francesca Forrestal | Assistant Analyst, Observer | NMFS |
| Will Patterson | ADT | GMFMC SSC |
| Sean Powers | ADT | GMFMC SSC |
| Jim Tolan | ADT | GMFMC SSC |
| Marcel Reichert | ADT | SAFMC SSC |
| Adyan Rios | Work Group member | NMFS |
| Tracey Smart | Work Group member | SCDNR |
| Judd Curtis | Work Group member | GMFMC SSC |
| Mandy Karnauskas | Work Group member | NMFS |
| Carole Neidig | Work Group member | Mote Marine Laboratory |
| Max Lee | Work Group member | Mote Marine Laboratory |
| Alexandra Smith | Observer | NMFS |
| Jessica Carroll | Observer, Data Provider | Florida FWC |
| Tracy McCulloch | Observer | NMFS |
| Guillermo Diaz | Observer | NMFS |
| Nancie Cummings | Observer | NMFS |
| Margaret Finch | Observer, Data Provider | SCDNR |
| Michelle Willis | Observer, Data Provider | SCDNR |
| Eric Fitzpatrick | Data compiler, Observer | NMFS |
| Rob Cheshire | Observer | NMFS |
| Jamie Clark | Observer | NMFS |
| Homer Hiers | Observer | |
| Wiley Sinkus | Observer | SCDNR |
| Stephen Long | Observer | |

2.2 REVIEW OF WORKING PAPERS GREMANE TO LIFE HISTORY

SEDAR68-DW-05: Reproductive Parameters for South Atlantic Scamp and Yellowmouth Grouper in Support of the SEDAR 68 Research Track Assessment

Gonad tissue samples of Scamp and Yellowmouth Grouper were collected from a fishery-independent survey and fishery-dependent port sampling within the US South Atlantic since 1979. Primary gears used to capture the fish were snapper reels (50%) and chevron traps (40%). All gonad tissues were histologically processed. Data recorded included sex of the fish, including transitionals, maturity staging,

based on Brown-Peterson et al. (2011), and fecundity estimates. Analyses of the data included sex ratio, age and length at maturity, maturity schedules, age and length at transition, spawning frequency, and batch fecundity. All analyses used recommended SEDAR best practice approaches. Functional maturity for females at calendar age and fork length were estimated by filtering data to include only developing, spawning capable and immature phases from spawning months (Feb–July), with developing and spawning capable phases representing mature females. This definition of maturity included specimens with oocyte development at or beyond the vitellogenic stage. All male specimens were considered sexually mature. Data from all months were used to estimate calendar age and fork length at sex transition. Juvenile females were included in these analyses, whereas transitional specimens were omitted.

The sex ratio data did not include immature females in order to restrict the ratio to the adult population, and transitionals were included with males. All males were considered mature. The measure of female maturity was based on developing, spawning, regressing, or regenerating oocytes and included females with oocytes at the cortical alveolar stage or beyond. Spawning frequency, imminent or recent spawning, was modeled on samples collected during spawning months (Feb – July) for ages 2 through 14+. Batch fecundity was modeled with a power function to be consistent with recent SEDARs where fecundity was thought to be a function of volume rather than length.

Recommendation:

The samples that were collected cover the majority of the range of the species in the South Atlantic. By having samples from various gears, they should be representative of the population. Standard procedures for analyzing the data were followed and are current with most up-to-date literature and SEDAR practices. Alternative models for batch fecundity could be explored to find best fit to the data. The reproductive parameters for Scamp/Yellowmouth Grouper complex were updated and further analyses and discussion are included in following report sections. The data and parameters are adequate for stock assessment inputs.

SEDAR68-DW-15: Scamp (*Mycteroperca phenax*) age comparisons between aging labs in the Gulf of Mexico and South Atlantic.

This report compared consistency of Scamp age estimates between labs in the Gulf of Mexico (GOM) and South Atlantic (SA) to ensure no bias would be introduced through these data. A calibration set of 400 samples was split evenly between GOM and SA. Four labs (Florida Fish and Wildlife Conservation Commission Fish and Wildlife Research Institute (FWRI), South

Carolina Department of Natural Resources (SCDNR), and NOAA Panama City and Beaufort labs) assigned ages, edge codes, and quality codes for the three analyses (average percent error, age-bias plots, Evans Hoenig & Baker symmetry tests) that calculate precision, illustrate patterns, and evaluate bias. Ranges of APE were satisfactory and there was no clear overaging or underaging bias among labs. Scamp aged 0–10 years were more precise compared to Scamp aged 11+, and represent the bulk of the data. Results indicate high precision among the aging labs within a region submitting data for the assessment.

Recommendation:

The reported analyses were well done and thorough, and the results indicated that readings are consistent with little bias and low average percent error (APE). There was no indication that these data would introduce bias. Therefore, they should be considered for use in the assessment.

SEDAR68-DW-19: Scamp grouper reproduction on the West Florida Shelf

A more comprehensive working paper was submitted (SEDAR68-DW-28).

SEDAR68-DW-20: Summary of preliminary age, length, and reproduction data for U.S. Gulf of Mexico Scamp, *Mycteroperca phenax*, submitted for SEDAR68

This working paper is a preliminary summary of Scamp life history data provided for the Gulf of Mexico by the NOAA Panama City Laboratory. It is broken out by years, mode and gear, sampling program, and state landed/captured. This is a large portion of the complete data set for Scamp in the Gulf of Mexico and will be very useful for any reproductive-based parameters for the assessment.

Recommendation:

Life history data from other sources, specifically FWRI, should be combined with the data summarized in this report for more robust analyses of growth and reproductive parameters (see following report sections). The data are useful as inputs to the GOM stock assessment.

SEDAR-68-DW-21: Summary of preliminary age and length data for U.S. Gulf of Mexico Yellowmouth Grouper, *Mycteroperca interstitialis*, submitted for SEDAR68

This working paper is a preliminary summary of Yellowmouth Grouper life history data provided for the Gulf of Mexico by the NOAA Panama City Laboratory. It is broken out by

years, mode and gear, sampling program, and state landed/captured. The data are considered part of the Scamp/Yellowmouth Grouper complex for the GOM, and will be incorporated into the full GOM life history data set for the species.

Recommendation:

These Yellowmouth Grouper life history data should be combined with the GOM Scamp data for more robust analyses of growth and reproductive parameters (see following report sections). The data are useful as inputs to the GOM stock assessment.

SEDAR68-DW-28: Scamp grouper reproduction in the Gulf of Mexico

The document summarizes analyses conducted on a combined dataset from the NMFS Panama City Lab and the Florida Fish & Wildlife Commission (FWC). The authors developed histological indicators for Scamp, assessed timing of reproduction, size and age at maturity and sex transition, spawning frequency, batch fecundity, and other aspects of reproductive biology. Most samples were collected by NMFS during 1972–2017 ($n=4,105$) from fishery-dependent, fishery-independent, and unknown sources, with the remaining samples collected by FWC during 2009–2017 ($n=459$) from fishery-independent and fishery-dependent surveys and a study targeting Gag Grouper along the western coast of Florida. Specimen age has not yet been determined for the FWC samples. The authors developed species-specific histological indicators to assess reproductive state and then used the resulting data to investigate maturity, sex ratio, reproductive timing, and spawning frequency of Scamp in the Gulf of Mexico. Various models were applied to estimate size and calendar age at maturity and at sex transition, spawning season duration, and spawning frequency.

Recommendation:

The methods used in this working paper were sound and often represented thoughtful improvements over standard methods. The overall dataset was large, but the samples were somewhat restricted to the western coast of Florida: 84% of the NMFS-Panama City specimens, and 100% of the FWC specimens. Assessing size and age at maturity in females was based on whether or not females were capable of spawning. Therefore, data were restricted to fish caught during the spawning season for analyses. While the definition “Actively Spawning” varies slightly on pages 2 and 3, it is understood to include those specimens with indicators of

imminent or recent spawning. This approach will reduce the number of samples available for regression analysis, but relies on very distinct histological characteristics and reduces observation error. Spawning season duration was estimated with a novel approach, which estimates the average start and end dates of the spawning season with binomial regression and calculates the difference between these dates. This should be much more robust than the standard method, which is based on estimates of the extreme start and end dates of the spawning season, and is very sensitive to sampling early and late in the spawning season. Spawning fraction was estimated from the proportion of all females with spawning indicators, which is different than how it is often calculated as a proportion of mature females. Calculating spawning frequency as a function of all females is an improvement that avoids the need to even estimate "maturity", and eliminates the uncertainty in maturity staging. Spawning frequency (number of spawns per year) was calculated as a function of spawning fraction, spawning season duration, and an assumed duration of spawning indicators. A regression was then run to estimate spawning frequency as a logistic function of age.

Sources of uncertainty that could potentially be of concern in Scamp are assumptions about duration of spawning indicators, and histological criteria that indicate sex transition, and the uncertain duration of transitional characteristics. This is worth nothing, but these are common issues with studies of this type, that may not be problematic. If the assumed duration of spawning indicators is an over/underestimated, spawning events will tend to appear less/more common which will tend to under/overestimate the number of spawns per season. In protogynous fish, individuals may contain varying amounts of male and female tissue in their gonads, and it is often unclear how quickly transition proceeds. Thus, characterizing fish as "transitional" can be of somewhat limited utility since it is not clear when a "transitional" fish will actually function as male. Regardless, this should not compromise sex-at-age functions reported in this paper, which excluded "transitional" individuals.

The analyses were very informative, and novel in the case of spawning duration, and generated very reliable reproductive inputs for the Gulf of Mexico Scamp/Yellowmouth Grouper assessment. The results of this study are recommended for use in the assessment.

2.3 AGE AND GROWTH DATA

2.3.1 Age calibration among data providers

Otoliths are the preferred age structure of Scamp, but they are considered difficult to interpret; thus, staff from the four laboratories contributing data to this SEDAR met for an ageing workshop to ensure the consistency in age readings of Scamp. They established the best methodology for sectioning the otoliths and interpreting the macrostructure of the otolith sections to assign ages to the samples. Following the ageing workshop, each lab contributed to a calibration set ($n = 400$) to be shared that was representative of each lab's processing technique, the full age range of available samples, location of fishing activity or surveys, and all months of the year. Overall average percent error (APE) between each pair of labs ranged from 4.63% to 6.37% and no significant over-ageing or under-ageing bias was found. Within a stock, APE values were 4.24% and 5.14% for the South Atlantic and Gulf of Mexico, respectively. The outcome of the ageing workshop and the exchange of the calibration sets suggested that data sets from the four laboratories could be combined for SEDAR68. Full results of the age comparisons can be found in SEDAR68-DW-15.

For all Scamp aged at Panama City, internal age reader agreements were calculated among the two age readers using a 20% overlap per year. For years prior to 2000, a retrospective reader overlap was completed ($n = 567$) among the same two age readers and APE was calculated at 6.35%. Due to Yellowmouth Grouper sections appearing significantly similar to Scamp sections, two Yellowmouth Grouper age readers participated in the Scamp ageing workshop as well as the exchange of calibration sets to ensure and maintain consistent ageing methodologies.

2.3.2 Source of samples

The final age data set as presented in this report represent only otoliths for which an observed age estimate was made by an age reader. The Gulf of Mexico Scamp and Yellowmouth Grouper age data set ($n = 13,283$) for years 1972–2019 was contributed by NMFS Panama City, FWRI Fishery Independent Monitoring (FWRI FIM), and Gulf States Fisheries Information Network (GulfFIN) (Table 1). The data consisted primarily of Scamp records ($n = 12,724$), but also included limited Yellowmouth Grouper records ($n = 559$). Data and biological samples were collected from the commercial fishery, recreational fishery, and fishery-independent surveys. The number of age samples provided from the commercial and recreational fisheries are shown in Tables 2 and 3, respectively. The number of age samples provided by fishery independent

surveys are shown in Table 4. Due to the large number of fishery dependent samples received, a subsampling protocol is in place to sample Gulf of Mexico Scamp by a randomly selected subset per fishing area grid (NMFS shrimp statistical grid) based on an average of five years of the most recently reported landings. Thus, age data is comparably represented throughout the U.S. Gulf of Mexico (Table 5).

2.3.3 Age and length data

Gulf of Mexico Scamp and Yellowmouth Grouper data were represented by a wide distribution of fork lengths (153 – 1070 mm; 528.87 ± 98.57 , mean \pm std. dev; $n = 13,233$). Most ($n = 2,620$) of the fork lengths occurred in the 500 – 550 mm bin. Ages ranged from 0 – 37 years (9.69 ± 4.63 , mean \pm std. dev; $n = 13,233$); however, the LHG recommends using a maximum age of 34 ± 2 years (see section 4).

Due to an increase in the number of otoliths from the commercial hand-line and long-line sectors, records (a minimum of $n = 500$) from each year and gear were sub-sampled randomly based on an average of yearly percentages of commercial landings per the National Marine Fisheries Service (NMFS) Shrimp Statistical Grids. All age data for Scamp from years 2003–2012 ($n \sim 10,254$), provided by NMFS Panama City, were removed due to concerns with otolith processing. The Benetec saw, which is currently used at the NMFS Northeast Fisheries Science Center, was utilized for otolith sectioning for this time series (2003–2012) of samples for Scamp, whereby 25 otoliths were set in epoxy blocks consisting of five rows with each row having five otoliths. Several cuts of the block were made, and a strip of five sections was glued to each slide. The issues in processing included but were not limited to: the initial use of black epoxy smearing, differences in core cuts among the sections on the strips (i.e., some otolith cuts were off-core and other otolith cuts were on-core for sections on the same strip), transposing of sections whereby the strip was flipped and otolith sections did not match up to the specimen number order on slides, several recuts had been made out of order, and a large number of otoliths ($n \sim 1,675$) that were recorded as unreadable by the age reader. The physical blocks as well as the paper grids designed to keep track of otolith section placement were disposed of making data reconciliation irreparable. The number of issues outlined here led to enough concern over using the age data processed on the Benetec saw, that the LHG felt it was best to remove the samples from further analysis. Scamp otoliths remaining in the archive at NMFS Panama City ($n \sim$

10,500) for years 2003–2012 will be sectioned using traditional, proven methods and equipment, and this age data will be made available for the upcoming SEDAR 68 Operational Assessment scheduled in 2021. Yellowmouth Grouper samples were not affected by the Benetec sectioning method, as they were processed using traditional methods and equipment.

To account for these removed samples, a novel approach was undertaken using otolith weight as a proxy of age that could be used temporarily for developing age compositions for years 2003–2012. Otoliths grow throughout the life of teleost fishes, and the size of otoliths (length and weight) are approximately proportional to fish size (Campana and Fowler 2012). As such, otolith size can provide some idea of fish age, similar to the way that fish size can be approximated for fish age (Campana and Fowler 2012). NMFS Panama City has a protocol in place that requires all whole left and/or right otoliths be weighed on an analytical balance prior to the otoliths being sectioned. Having this established protocol afforded the opportunity to analyze the otolith weight – age relationship so that a temporary proxy age could be made available for developing age compositions for years 2003–2012 (i.e., years that the Benetec saw was used to section Scamp otoliths). All samples with an available left otolith weight and an observed age estimate ($n = 5,455$) across all years, except 2003–2012, were used in linear regression analysis, where age in years was the dependent variable and left otolith weight in grams was the independent variable. No NMFS Panama City Scamp age data were used from years 2003–2012 in the regression analysis (Table 6). Left otolith weight was chosen since there were few right otolith weights available in the NMFS Panama City data set and because the left otolith is most often the only otolith sampled by port samplers. Prior to the regression analyses, assumptions of normality, linearity, and homogeneity of variances were checked with Q-Q plots (normality) and residuals (linearity, homogeneity of variances). Two simple linear regression models were investigated: 1) calendar age regressed on left otolith weight, and 2) fractional age regressed on left otolith weight (Table 7; Figures 1, 2). Seven multiple regression models with calendar age regressed on combinations of left otolith weight with fork length, NMFS grid where fish were caught, month of capture, histological sex, and/or gear type, were also investigated. Since all regression models had similar R^2 values that ranged from 0.6517 to 0.6652, the LHG recommended the simple linear regression model of calendar age regressed on left otolith weight as a model to produce a temporary proxy of age that could be used for developing age compositions of landings for years 2003–2012 (Table 7; Figure 1). For years 2003–2012, there are approximately $n = 3,574$ records

where otolith weight is available for which this linear regression model (i.e., calendar age regressed on left otolith weight) could be used to temporarily provide a proxy of age for the 2003–2012 age compositions of landings.

Calendar, or cohort, ages are assigned based on annual ring counts and edge type codes. The edge, or margin, codes refer to the presence of an opaque zone or the width of a translucent zone that is located on the edge of the otolith beyond the last complete annual ring. Age readers at the NMFS Panama City classify an opaque zone on the edge as edge code = 2, a translucent zone forming with 1/3 to 2/3 of new growth after the last opaque zone as edge code = 4, and a translucent zone forming with greater than 2/3 of new growth after the last opaque zone as edge code = 6. GulfFIN and FWRI FIM age readers classify an opaque zone on the margin as edge code = 1, a translucent zone on the margin < 1/3 complete as edge code = 2, a translucent zone on the margin that is 1/3 to 2/3 complete as edge code = 3, and a translucent zone on the margin > 2/3 complete as edge code = 4 (GSMFC 2009). The criteria for converting annuli counts to calendar ages is as follows:

1. For all fish landed between January 1 and June 30 with a wide translucent zone (NOAA PC edge code = 6, GulfFIN and FWRI FIM edge code 3 or 4), calendar age = annuli count + 1.
2. For all fish landed between January 1 and June 30 with an opaque zone on the margin (NOAA PC edge type = 2, GulfFIN and FWRI FIM edge code = 1), or a narrow translucent zone (NOAA PC edge type = 4, GulfFIN and FWRI FIM edge code = 2), calendar age = annuli count.
3. For all fish landed between July 1 and December 31, calendar age = annuli count.

In addition to the calendar ages, fractional (biological) ages were also provided for use in the growth models. Fractional ages were based on the calendar ages and the date of peak spawning, April 15, for the Gulf of Mexico stock. Date of peak spawning was based on peak gonadosomatic Index (GSI) occurring in April (see Section 2.5 REPRODUCTION). The equation for calculating fractional age for Scamp and Yellowmouth Grouper in the Gulf of Mexico is:

$$A_F = A_C + ((D_C - D_S)/365), \text{ where}$$

A_F = fractional age (years),
 A_C = calendar age (years),
 D_C = date of capture, and
 D_S = date of peak spawning.

The LHG recommended using all age and growth data for Scamp and Yellowmouth Grouper from all data providers for SEDAR 68 once all of the Scamp age data provided by NMFS Panama City Lab for years 2003–2012 have been removed from the data set. All Yellowmouth Grouper age and growth data provided by the NMFS Panama City Lab for years 2003–2012 should be included since the otoliths were sectioned using traditional methods and equipment. The LHG also recommended the temporary use of the simple linear regression model, calendar age (years) regressed on left otolith weight (grams) to produce a proxy of age that could be used temporarily for the landings age compositions for years 2003–2012 (i.e., years for which the Benetec saw was used to section Scamp otoliths).

2.3.4 Modeling Growth

Growth of Scamp and Yellowmouth Grouper in the Gulf of Mexico was modeled for the population using a von Bertalanffy growth model in AD Model Builder (ADMB). To account for growth of the fish throughout the year, the fractional age and fork length of each sample was used in the model. Records that included both fractional ages and fork length provided by all data providers ($n = 13,233$ out of 13,283) were used in the growth models, including $n = 175$ Yellowmouth Grouper provided by NMFS Panama City and $n = 426$ Scamp provided by GulfFIN and FWRI FIM for years 2003–2012 (Table 8). No estimated ages from the otolith weight – age linear regression model for Scamp from years 2003–2012 were used in the growth models as these data were only provided as a temporary placeholder for developing age compositions of landings. For the population model, each age data sample was identified to the source of the sample, specifically commercial fishery, recreational fishery or fishery-independent. These designations were important in the population growth model because the fishery-dependent samples were subject to the minimum size regulations since November 24, 1999 (Reef Fish Amendment 16B), which in effect allows the fastest growers at the youngest ages to be retained in the fishery landings. The population growth model includes a statistical correction for the left-truncated distribution (McGarvey and Fowler, 2002). Multiple model compilations were examined using four different variance structures: constant SD with age, constant CV with age, CV increases linearly with age, and CV increases linearly with size (Table 9). Scamp and Yellowmouth grouper displayed a constant CV with age (Figure 3) and had a similar objective function and growth model parameters as the growth model where CV

increases linearly with age (Table 9). Due to the increased uncertainty in the age readings of the oldest fish, the LHG recommended two growth models for consideration: constant CV across all ages (Figure 4) and estimate CV as a linear function of age (Figure 5). Additional models combining females and males together were also run and VBGF predicted growth for combined females and males were overlain on the recommended growth models (Table 9, Figures 6, 7). Only fish that were histologically identified as functional females and males were used in these growth models. To overcome 90% of the Gulf of Mexico age data being represented by ages 1–15, each data point was weighted by the inverse of the sample size at each sample's calendar age. Those data were driving the population model and not fitting the size-at-age of the oldest fish well. The growth model parameters are included in Table 9.

ADT Recommendation

Use inverse weighting and the population growth models, Constant CV and CV increases linearly with age, as presented.

2.4 NATURAL MORTALITY

Natural mortality (M) of a fish species is often estimated using its life history parameters due to the difficulty in estimating M directly. Based on past assessments, the LHG had discussions about maximum age, use of point estimates of M and age-varying M s based on size-at-age. Many equations to calculate a point estimate of M are available, but the equations using maximum age of the population are preferred (Hoenig, 1983; Then et al., 2015). It is believed that the early life stages of a fish make them more vulnerable to natural mortality than the older, mature fish. For that reason, equations that estimate M as a function of size-at-age (Lorenzen, 1996; Charnov et al., 2012) were prioritized for this assessment.

The LHG first discussed the maximum age of Scamp in the region. The maximum ages of Scamp in the South Atlantic and the Gulf of Mexico data sets were recorded as 34 years and 35 years, respectively, which is similar to the maximum age of 31 years previously reported for Scamp (Lombardi-Carlson et al. 2012). Two Yellowmouth Grouper samples from the U.S. Gulf of Mexico had maximum ages of 36 and 37 years. A recent bomb radiocarbon study (Pers. comm. Linda Lombardi-Carlson and Beverly Barnett, NMFS Panama City Laboratory) on a limited number of available samples was validated to a maximum age of 25 years (range = 24 –

27 years). However, one sample in the same study was aged 33 years by all four labs engaged in ageing Scamp, but due to Benetec processing issues described above (see section 3.3), the age for this sample could not be validated. A calibration set shared among the four ageing labs (SEDAR68-DW-15) consistently found a maximum age of 34 years. Due to the potential for uncertainty in consistently ageing the oldest fish in the calibration data set, the LHG proposed a range about the single maximum age of 34 years to be used in uncertainty analyses for both regions. From the calibration set ages recorded by all age readers, the error calculated around the oldest fish was computed. The LHG recommended a range of ± 2 years to be used. This maximum age is plausible because data from the Gulf of Mexico stock had 14 samples aged 30+, while the South Atlantic data contained six samples. The Gulf of Mexico samples came from fish caught during more recent years and have survived through a time of heavy exploitation. The LHG thinks that a maximum age of 34 years is reasonable since it was found in multiple data sets and across many years. Max age for Yellowmouth Grouper (31 years, Burton et al. 2014) was similar to that found for Scamp in both stocks.

The LHG decided that M as a function of size-at-age was the most appropriate data input for the stock assessment because smaller fish are more susceptible to predation than older, larger fish. Two age-varying M estimates were initially considered from two approaches: (1) Charnov et al. (2012) and (2) Lorenzen (1996). Recent South Atlantic SEDAR assessments have used Charnov et al. calculations, while Gulf of Mexico SEDAR assessments have used Lorenzen. A member of the LHG reached out to both Lorenzen and Charnov to seek their inputs into their respective data sets used for their calculations of M . Lorenzen re-analyzed his estimate of size-varying M using his original data set and the data set from Charnov et al. (2012). Lorenzen's data set and estimation procedure better addresses the population level natural mortality, whereas Charnov et al.'s estimator works better at a community level. Lorenzen made a strong argument that the new analyses resulted in an equation more similar to his original equation (manuscript in prep). Lorenzen advised that the natural mortality vector be scaled for the species using the Then et al. (2015) point estimate using t_{max} . His reasoning was that, depending on the species, the mortality vector from his equation may not allow for the fish to survive to the maximum age. Then et al. (2015) recommend that, for each species to which their natural mortality estimator is applied, the analyst evaluate the Then et al. (2015) data set (available at https://www.vims.edu/research/departments/fisheries/programs/mort_db/index.php) and rerun

the regression on a subset of species with more similar life history strategies to their focal species. Therefore, we calculated a new M estimator for Scamp and Yellowmouth Grouper.

The LHG considered the data used in the Then et al. (2015) point estimate of M based on t_{max} , which consisted of 227 data points from across multiple species and families and resulted in $M = 0.1938$ for Scamp/Yellowmouth Grouper. Criteria for sub-setting the data suggested by members of the LHG include having a sufficient range in maximum ages and enough data points for the regression to be robust. It was further suggested that species from similar habitats were important, such as tropical/sub-tropical reef fish or demersal species rather than pelagic or cold-water species. With those criteria set out, the full data set was subsetted based on reef fish families to include Serranidae (groupers), Sparidae (porgies), Pomacanthidae (angelfishes), Pomacentridae (damsel-fishes), Scaridae (parrotfishes), Malacanthidae (tilefishes), Labridae (wrasses), Lutjanidae (snappers), Haemulidae (grunts), Carangidae (jacks), and Acanthuridae (surgeonfishes) ($n = 67$). A few families were excluded immediately due to concern over the ageing methodology (e.g., Balistidae [triggerfishes] and Polyprionidae [wreckfishes]). The regression equation including these reef fish families resulted in $M = 0.193$. Some of the relevant literature cited by Then et al. (2015) was reviewed by various members of the LHG. Many of the studies drew concern over ageing methodology or how M was calculated. Many of the M values were based on catch-curve analysis of unfished or lightly fished stocks. Concern was also raised about including reef fish species that had very different life history strategies or maximum sizes compared to groupers. One suggestion was made to limit the data points to species in the same family that exhibit similar trophic levels to groupers. Thus, the 12 Serranidae species were chosen to rerun the regression. The Serranids ranged in age from 7 to 85 years and estimates of M ranged from 0.078 to 0.68 (Figure 8). The regression based on those 12 data points calculated an M of 0.155. The LHG proposed to use the Lorenzen (1996) mortality vector scaled to the Serranids only point estimate of M for both the South Atlantic and the Gulf of Mexico stocks (Table 10, Figure 9). The M vector for each stock would use the stock specific growth model (see Section 3.4) and weight-length equations (see Section 6) in the calculations. Scaling of the M vector was based on the survivability of the fully recruited ages, ages 6–34 for both stocks. The LHG group did note that a more thorough review of the literature cited in Then et al. (2015) is needed, as well as investigation in the most appropriate way to subset the data for other SEDAR species.

ADT Recommendation:

1. Maximum age of Scamp/Yellowmouth Grouper is 34 years with a range of ± 2 years for both the South Atlantic and the Gulf of Mexico stocks.
2. Use natural mortality vector as a function of mean size-at-age using Lorenzen (1996) equation and scaled to Then et al. (2015) point estimate using a re-calculated t_{max} regression based on data gathered for Serranid species. This method will be applied to both the South Atlantic and the Gulf of Mexico stocks.

2.5 REPRODUCTION

A previous study on Scamp reproduction in the GOM (Lombardi-Carlson et al., 2012) provided estimates of size and age at maturity and transition for fish sampled primarily on the west Florida shelf between 1972 and 2002. The data used in that study, provided by NMFS Panama City, were re-analyzed for SEDAR 68 along with new information collected by NMFS Panama City for 2003–2017 and by FWRI for 2009–2017. Since age information was not available for FWRI samples, only NMFS Panama City samples were used for estimating age at maturity and transition, while all samples are included in size at maturity and transition analyses.

2.5.1 Maturity

Scamp are protogynous hermaphrodites (i.e., transition from female to male in their lifetime); therefore, all male or transitioning fish were considered mature in this assessment. Due to testes continuing to have ovarian walls and often large numbers of primary growth oocytes, histological analysis is needed to assign sex. Differences between labs and assignment of maturity over time were discussed, particularly criteria used as maturity indicators. There is no definitive histological indicator to distinguish immature from mature regenerating females, which both have only primary growth (PG) oocytes. However, because maturity is a process, it is possible to use the histological appearance of other aspects of the gonad to distinguish young immature females from old regenerating females. These include: a clearly defined lumen, the density and organization of the PG population, thickness of the ovarian wall, presence of capillaries and sometimes the occurrence of muscle bundles extending from the ovarian wall into the ovarian lamellae—but this last criterion is often difficult to use in groupers (Lowerre-Barbieri et al., 2011; Lowerre-Barbieri et al. 2015). This level of histological detail was not

always available for historical samples and immature females were excluded from the historical data (i.e., samples using the 2004 histological classification protocol). Thus, for size and age at maturity estimates we used only spawning capable and immature due to known issues distinguishing between immature and regenerating individuals. Scamp, like Red Grouper (SEDAR 42), exhibit a high degree of parasitism, and there was concern that maturity assignments resulting from the NMFS Panama City 2004 histological protocol were unreliable due to the reliance on brown bodies as an indicator of previous spawning which were easily confused with parasites. The NMFS Panama City group is currently reanalyzing their historical slides with the above criteria to evaluate what is needed to standardize assignments throughout their data set.

To minimize the influence of error in assigning maturity status on estimated maturity parameters, the following decisions were made for combining NMFS Panama City and FWRI histology samples:

- Include only immature (reproductive phase 1) and spawning capable (reproductive phase 3 or 4) fish, and exclude immature females from historical NMFS data
- Include only samples collected during the spawning season (defined as the first to last day when females with spawning indicators were sampled, 2 February – 25 July)
- Censor bad histological preparations

The final maturity data set ($n = 763$) included fish ranging in size from 106 mm FL to 833 mm FL, with the smallest mature female being 281 mm FL (Figure 10). Maturity data for which age information was available ($n = 413$) included fish ranging from ages 1 to 19. Binomial generalized linear models (GLMs) were used to model maturity at age and length. Different link functions (logit, probit, cloglog and cauchit) were specified, and the best model was chosen via Akaike Information Criterion (AIC). The logit link function provided the best fit to maturity at age data, and the probit link was the best fitting model for maturity at length. The predicted age and length at 50% maturity were 3.41 years and 363.7 mm TL, respectively (Table 11; Figure 11). These estimates are older and larger than those previously presented in Lombardi-Carlson et al. (2012), which used the historical histological criteria and estimated median age and length at maturity to be 2 years and 332 mm FL, respectively.

2.5.2 Sexual Transition

As with maturity, NMFS Panama City and FWRI data were combined and binomial GLMs with different link functions were specified to estimate transition at length and age parameters. The final data set for determining transition at length included 4,412 fish (1,669 males and 2,743 females), and that for transition at age included 1,937 (700 males and 1,237 females). There was significant overlap in size between males and females; however, males were larger on average than females, while fish in transition (i.e., transitionals) were intermediate in size (Figure 12). The youngest observed males were three years old and the smallest observed male was 221 mm (there was no age for this individual). Transitional individuals were excluded from modeling due to uncertainty about their functional status as male or female. Transitionals ($n=136$) ranged in size from 299 to 710 mm FL, with a mean size of 499.8 mm FL. Sex change occurred over a wide range of times, as indicated by the collection of transitionals in every month of the year. Estimated size at 50% male was 555.6 mm FL (logit fit; Table 11; Figure 13) and age at 50% male was 10.8 years (probit fit; Table 11; Figure 13). These estimates are similar to those of Lombardi-Carlson et al. (2012): 566 mm FL and 11 years.

2.5.3 Sex ratio and mating system

Of all fish sampled, there were 1,675 males, 2,754 females and 135 transitionals. The earlier period (1972–2002) had a male sex ratio of 36% (914 males, 1,638 females, and 82 transitionals) compared to 41% in more recent sampling (2003–2017; 761 males, 1,116 females and 53 transitionals). In the 1970s the male sex ratio was estimated at 37.9%, with a decrease to 18–24% in the 1990s (Coleman et al., 1996) and has now increased to 41%. Sex-specific gonadosomatic indices during the core spawning months (March through May), were quite low (female mean: 1.38 +/-1.24; male: 0.27+/-0.11). A similar lack of milt reserves has been documented in Gag Grouper and is considered an indicator of pair spawning (Lowerre-Barbieri et al., 2020).

2.5.4 Fecundity

Spawning season and spawning frequency were estimated for SEDAR 68. However, due to low samples of batch fecundity with weight ($n=5$) and age ($n=9$), annual fecundity could not be estimated. Although the estimate of spawning season length has a large impact on spawning frequency estimates, there is no standardized method to assign spawning season. Due to low numbers of aged samples, it was not possible to estimate age-specific spawning seasons. To assess the total population duration of spawning activity, the first and last dates that female

active spawners were observed was defined as the population spawning season. However, due to spawning activity being asynchronous and not evenly distributed over this time period, the core spawning season (i.e., 50% or more of the females were spawning capable) was also estimated using a binomial regression to model calendar date and spawning state data. Spawning capable and developing females were selected to determine the mid-point for the beginning of the spawning season and spawning capable and regressing females were used to estimate when > 50% of females were no longer spawning capable. Females with spawning indicators were first sampled on 2 February and last sampled on 25 July (spawning season duration=173 d). However, most spawning capable females (88%) were collected in the months of March, April and May. Actively spawning females and female GSI also peaked in April. Using a binomial regression to estimate the time period over which 50% or more of mature females are spawning capable, the estimated spawning season was March 9th through May 26th (79 d) using the cloglog link, and under the probit fit, it was February 28 through June 7 (100 d). The probit model estimate is considered the best, as it better captures the time period when the majority of active spawning was observed.

Due to the need for some fish to still be aged, only 751 females sampled during the spawning season could be used for age-specific spawning fraction estimates. Estimated spawning fraction was zero for ages 1 and 2, then increased for ages 3 and 4, and started plateauing at age 5. The largest spawning fraction was observed for age six (shortest spawning interval of 4.44 days) which was also the age group with the largest available sample size ($n_{\text{age6}} = 100$). After age 12, available samples decreased to fewer than 20, and ages 14 to 19 were pooled due to low sample size. Thus, it is not possible to confirm that the declining apparent spawning fraction with age was not affected by lower sample sizes. Spawning frequency under the logistic model plateaued at 16.5 days per season for the best measure of spawning season duration (100 days; Figure 14). Given that spawning frequency is traditionally estimated as the number of days in the spawning season divided by the spawning interval (reciprocal of spawning fraction), spawning frequency was 28.5 days per season for the longer seasonal duration (173 days) and 13 days for the shortest estimate of the spawning season (79 days).

2.5.5 *Measure of reproductive potential*

Because Scamp do not exhibit a 1:1 sex ratio and there are significant differences between sexes in size and age, the recommendation is to use combined spawning stock biomass for the base model—thus integrating males into the estimate of reproductive potential (Brooks et al., 2008). However, given that the optimal sex ratio in Scamp is unknown we recommend conducting sensitivity runs that include: female only SSB, male only SSB, and combined runs with the alternating sex down-weighted to $0.5 \times \text{SSB}$.

ADT Recommendation

Use the LHG recommended parameters as the most appropriate reproduction data for the Gulf of Mexico.

2.6 MERISTIC CONVERSIONS

Fishery-dependent monitoring and fishery-independent surveys collect different measurement types on fish, which may need to be converted to standardized types for consistency in data inputs for SEDAR68 Scamp/Yellowmouth Grouper. The SEDAR 68 panel assigned the length type and fish weight for the biological data inputs to be in fork length (cm) and gutted weight (kg), respectively. Meristic data collected on fish landed or surveyed within the GMFMC jurisdiction with paired length types, weight-length and whole weight – gutted weight data were compiled for the regression analyses. Data included were from the Trip Interview Program (TIP), Southeast Region Headboat Survey (SRHS), Marine Recreational Information Program (MRIP), Southeast Reef Fish Survey (SERFS), GulfFIN, and the Shark Bottom Longline Observer Program (SBLOP). Linear regressions for length-length and LN transformed weight and length were modelled. The weight-length equations were converted to the power equation, $W = aL^b$, adding $\frac{1}{2}$ mean squared error (MSE) for transformation bias. Whole weight – gutted weight measurements were collected from fishery-dependent landings data. All lengths were in cm, and all weights were in kg for the various comparisons. Tables 12a, 12b, and 12c provide the parameters, standard errors, sample sizes and ranges of each independent variable.

Comparison of the regression equations from the South Atlantic to those from the Gulf of Mexico revealed similarities and differences. The length – length equations yielded essentially the same results. On the other hand, the weight-length equations were different. Fish from the Gulf of Mexico appeared to be heavier at length than the ones from the South Atlantic after ~ 700

mm FL. A greater proportion of fish larger than 700 mm FL with accompanying whole weights were recorded in the South Atlantic (18% of 17,614) compared to the Gulf of Mexico (2% of 12,660). The LHG recommended that the conversion equations remain separated by area based on these slight differences.

The LHG reviewed data inputs for the whole weight – gutted weight conversion. The whole weight – gutted weight relationships between the areas were different in the estimated slopes by region: 1.07 for the South Atlantic and 1.03 for the Gulf of Mexico. The data source for the South Atlantic was from SCDNR and was primarily from the fishery-independent survey (SERFS) since 2010, while the majority of the data from the Gulf of Mexico was from FWRI fishery dependent monitoring in 1979–1980 of the commercial fishery. The range of the data from the South Atlantic was greater than the Gulf of Mexico (Figure 15). The resulting slope of the combined data was 1.05, which is a value more in line with the conversion factor used for other grouper species. Because of the overall range and sources of the data available, the LHG recommended using results of the combined data for the whole weight – gutted weight conversion, and if needed, a gutted weight – whole weight conversion is also provided for the U.S. Gulf of Mexico (Table 12d).

ADT Recommendation:

Use the meristic conversion equations as presented in Table 12 for the Gulf of Mexico jurisdiction. Use a combined South Atlantic and Gulf of Mexico whole weight – gutted weight equation to be applied to both areas.

2.7 RESEARCH RECOMMENDATIONS

2.7.1 *Natural Mortality*

- Convene a topical workgroup or other workshop to critically review literature used in Then et al. (2015), discuss recent advancements in ageing approaches (e.g., Gray Triggerfish), and propose best options for selecting species for inclusion in regression analyses for reef fish species in the US Southeast Region to be used in estimating natural mortality.

- Research the Thorson FishLife program for use in natural mortality estimates and measures of uncertainty. <https://github.com/James-Thorson-NOAA/FishLife>

2.7.2 Reproductive Biology

- Investigate the male contribution to spawning success and the potential for sperm limitation in the population through model simulations and field research that will fill in critical gaps in knowledge (i.e., fertilization rate under various sex ratio scenarios, mating strategy) and continue to monitor sex ratio.
- Additional sampling with better spatial and especially temporal coverage to confirm preliminary results that male gonadosomatic index (GSI) indicates that Scamp are spawning in pairs or small groups. This information is lacking for Yellowmouth Grouper.
- Collect all sizes of Yellowmouth Grouper and larger female Scamp (> 650 mm FL) during the spawning season to assess batch fecundity and thereby fill a data gap that prevents estimating total egg production.
- Given the likely smaller population size of Yellowmouth Grouper, samples with a wide range of size/age, from fishery-dependent and fishery-independent sources, are needed to determine reproductive parameters for this species and to allow comparisons with those of Scamp.
- Maturity: Develop standardized histological criteria for assigning maturity, as well as a means of estimating uncertainty associated with incorrect assignments.
- Fecundity: More data on batch fecundity is needed, as is data from older fish to assess age-specific spawning frequency.
- There is a need for spatially-referenced reproductive data to better identify scamp spawning sites, whether scamp aggregate to spawn and if they undertake migrations to specific spawning habitat, as well as to understand if there is a spatial component to where sex change occurs.
- Sex ratios: there is a need to study the scamp mating strategy, which is currently unknown to better understand optimal sex ratios in this species and drivers of sex change.

- Form of reproductive potential: There is a need to develop a decision tree that can help inform what measure of reproductive potential is best, given key metrics observed in hermaphroditic fishes including overlap in sizes and ages and sex ratio.

2.8 LITERATURE CITED

- Brooks E.N., Shertzer, K.W., Gedamke, T., and Vaughan, D.S. (2008) Stock assessment of protogynous fish: evaluating measures of spawning biomass used to estimate biological reference points. *Fishery Bulletin* 106: 12–23.
- Burton, M.L., Potts, J.C., and Carr, D.R. (2014) Age, Growth, and Mortality of yellowmouth grouper from the Southeastern United States, *Marine and Coastal Fisheries*, 6:1, 33–42. DOI:10.1080/19425120.2013.866998
- Campana, S.E. and Fowler, G.M. (2012) Age Determination without tears: statistical estimation of silver hake (*Merluccius bilinearis*) age composition on the basis of otolith weight and fish length. *DFO Can. Sci. Advis. Sec. Res. Doc.* 2012/079. Ii + 19 p.
- Charnov, E.L., Gislason, H., and Pope, J.G. (2012) Evolutionary assembly rules for fish life histories. *Fish and Fisheries* 14(2):213–224.
- Coleman, F.C., Koenig, C.C., and Collins, L.A. (1996) Reproductive styles of shallow-water groupers (Pisces: Serranidae) in the eastern Gulf of Mexico and the consequences of fishing spawning aggregations. *Environmental Biology of Fishes* 47:129–141.
- Gulf States Marine Fisheries Commission. (2009) A Practical Handbook for Determining the Ages of Gulf of Mexico Fishes Second Edition. <https://www.gsmfc.org/publications/GSMFC%20Number%20167.pdf> (accessed 24 October 2020).
- Hoening, J. (1983) Empirical use of longevity data to estimate mortality rates. *Fishery Bulletin* 82(1):898–903.
- Lombardi-Carlson, L., Cook, M., Lyon, H., Barnett, B., and Bullock, L. (2012) A description of age, growth, and reproductive life history traits of scamps from the northern Gulf of Mexico. *Marine and Coastal Fisheries* 4(1):129–144.
- Lorenzen, K. (1996) The relationship between body weight and natural mortality in juvenile and adult fish: a comparison of natural ecosystems and aquaculture. *Journal of Fish Biology* 49(4):627–642.
- Lowerre-Barbieri, S., Ganas, K., Saborido-Rey, F., Murua, H., and Hunter, J. (2011) Reproductive timing in marine fishes: variability, temporal scales, and methods. *Marine and Coastal Fisheries: Dynamics, Management, and Ecosystem Science* [online serial] 3:71–91.

- Lowerre-Barbieri, S., Crabtree, L., Switzer, T., Walters Burnsed, S., and Guenther, C. (2015) Assessing reproductive resilience: an example with South Atlantic red snapper *Lutjanus campechanus*. *Marine Ecology Progress Series* 526:125–141.
- Lowerre-Barbieri, S., Menendez, H., Bickford, J., Switzer, T.S., Barbieri, L., and Koenig, C. (2020) Testing assumptions and model predictions about sex change and spatial management in a protogynous grouper, Gag, *Mycteroperca microlepis*. *Marine Ecology Progress Series* 639:199–214.
- McGarvey, R., and Fowler, A.J. (2002) Seasonal growth of King George whiting (*Sillaginodes punctata*) estimated from length-at-age samples of the legal-size harvest. *Fishery Bulletin* 100(3):545–558.
- Then, A.Y., Hoenig, J.M., Hall, N.G., and Hewitt, D.A. (2015) Evaluating the predictive performance of empirical estimators of natural mortality rate using information on over 200 fish species. *Journal of Marine Science*, doi: 10.1093/icesjms/fsu136.

2.9 TABLES

Table 1. The number of Scamp and Yellowmouth Grouper otoliths received (number aged) for SEDAR68 by year and data provider. Data providers include Florida Wildlife Research Institute Fisheries Independent Monitoring (FWRI FIM), Gulf States Fisheries Information Network (GulfFIN), NMFS Panama City Age, Growth and Reproduction (AGR) database, and NMFS Panama City Biological Sampling Database (BSD). Shading indicates years 2003 – 2012 for which ages of Scamp were removed from the NMFS Panama City datasets due to processing issues resulting from a new Benetec saw. NMFS Panama City ages shown for 2003 – 2012 are for Yellowmouth Grouper only.

| Year | FWRI FIM | GulfFIN | NMFS Panama City - AGR | NMFS Panama City - BSD | Total |
|------|----------|---------|------------------------|------------------------|---------------|
| 1972 | | | 6 (6) | | 6 (6) |
| 1973 | | | 8 (7) | | 8 (7) |
| 1977 | | | 47 (36) | | 47 (36) |
| 1978 | | | 37 (23) | | 37 (23) |
| 1979 | | | 293 (203) | | 293 (203) |
| 1980 | | | 197 (140) | | 197 (140) |
| 1981 | | | 118 (114) | | 118 (114) |
| 1986 | | | 51 (43) | | 51 (43) |
| 1987 | | | 11 (8) | | 11 (8) |
| 1988 | | | 13 (13) | | 13 (13) |
| 1989 | | | 19 (19) | | 19 (19) |
| 1990 | | | 4 (4) | | 4 (4) |
| 1991 | | | 320 (253) | | 320 (253) |
| 1992 | | | 196 (170) | | 196 (170) |
| 1993 | | | 439 (346) | | 439 (346) |
| 1994 | | | 324 (244) | | 324 (244) |
| 1995 | | | 242 (201) | | 242 (201) |
| 1996 | | | 287 (241) | | 287 (241) |
| 1997 | | | 106 (101) | | 106 (101) |
| 1998 | | | 127 (120) | | 127 (120) |
| 1999 | | | 184 (176) | | 184 (176) |
| 2000 | | | 232 (211) | | 232 (211) |
| 2001 | | | 1,245 (1,133) | | 1,245 (1,133) |
| 2002 | | | 1,914 (1,703) | | 1,914 (1,703) |
| 2003 | | | 3,138 (8) | | 3,138 (8) |
| 2004 | | | 2,227 (15) | | 2,227 (15) |
| 2005 | | | 2,025 (3) | | 2,025 (3) |
| 2006 | 4 (3) | | 1,591 (10) | | 1,595 (13) |
| 2007 | 5 (5) | | 1,900 (14) | | 1,905 (19) |
| 2008 | 12 (11) | | 2,447 (6) | | 2,459 (17) |
| 2009 | 97 (93) | 5 (5) | 2,087 (13) | | 2,189 (111) |

| | | | | | |
|-------|-----------|-----------|----------------|----------------|-----------------|
| 2010 | 206 (195) | 4 (4) | 2,086 (17) | | 2,296 (216) |
| 2011 | 49 (49) | 19 (19) | 183 (3) | 2,266 (17) | 2,517 (88) |
| 2012 | 44 (42) | | 286 (1) | 3,720 (69) | 4,050 (112) |
| 2013 | 136 (134) | | 376 (345) | 3,433 (987) | 3,945 (1,466) |
| 2014 | 23 (23) | | 221 (212) | 2,475 (1,093) | 2,719 (1,328) |
| 2015 | 52 (51) | 186 (158) | 117 (113) | 2,597 (1,085) | 2,952 (1,407) |
| 2016 | 50 (47) | 200 (195) | 72 (67) | 3,745 (1,163) | 4,067 (1,472) |
| 2017 | 42 (42) | 44 (43) | 66 (58) | 2,831 (1,231) | 2,983 (1,374) |
| 2018 | 62 (61) | 67 (55) | | | 129 (116) |
| 2019 | | 3 (3) | | | 3 (3) |
| Total | 782 (756) | 528 (482) | 25,242 (6,400) | 21,067 (5,645) | 47,619 (13,283) |

Table 2. Number of all Scamp and Yellowmouth Grouper samples aged (number of trips intercepted) from the commercial fishery listed by year, gear, and state landed.

| Gear Group YEAR | Vertical hook and line | | | | | Bottom Longline | | | Spears | Other | | Total |
|--------------------|------------------------|-----------|--------|----------|----------|-----------------|---------|--------|---------|-------|-------|-------|
| | AL | FL | MS | LA | TX | FL | LA | TX | FL | FL | LA | |
| 1977 | | 20 (3) | | | | | | | | | | 20 |
| 1978 | | 15 (3) | | | | | | | | | | 15 |
| 1979 | | 149 (29) | | | | | | | | | | 149 |
| 1980 | | 96 (16) | | | | | | | | | | 96 |
| 1981 | | 102 (10) | | | | | | | | | | 102 |
| 1991 | | 119 (10) | | 80 (22) | | 19 (3) | 5 (1) | | | | 1 (1) | 224 |
| 1992 | | 7 (3) | | 51 (17) | | 12 (6) | 38 (15) | | | | | 108 |
| 1993 | | 123 (25) | | 138 (44) | 4 (1) | 27 (7) | 12 (2) | | | | | 304 |
| 1994 | | 81 (20) | | 36 (19) | | 8 (1) | | | | | | 125 |
| 1995 | | 109 (32) | | 1 (1) | | 3 (3) | | | | | | 113 |
| 1996 | | 64 (19) | | | | 21 (6) | | | | | | 85 |
| 1997 | | 10 (4) | | | | 27 (5) | | | | | | 37 |
| 1998 | | 31 (8) | | | | 34 (7) | | | | | | 65 |
| 1999 | | 26 (8) | | | | 70 (26) | | | | | | 96 |
| 2000 | | 50 (9) | 2 (1) | | | 120 (27) | | | | | | 172 |
| 2001 | | 356 (58) | 14 (3) | 47 (16) | 1 (1) | 681 (109) | | | | | 1 (1) | 1,100 |
| 2002 | | 299 (61) | 14 (4) | 18 (6) | 2 (1) | 1,227 (143) | 16 (1) | | | | 1 (1) | 1,577 |
| 2003 | | 1 (1) | | | | 7 (4) | | | | | | 8 |
| 2004 | | 3 (1) | | | | 12 (4) | | | | | | 15 |
| 2005 | | | | | | 3 (3) | | | | | | 3 |
| 2006 | | 1 (1) | | | | 9 (5) | | | | | | 10 |
| 2007 | | | | 3 (3) | | 8 (7) | | | | | | 11 |
| 2008 | | | | 1 (1) | | 5 (3) | | | | | | 6 |
| 2009 | | 2 (2) | | 6 (5) | 2 (1) | 2 (1) | | | 1 (1) | | | 13 |
| 2010 | | | | 7 (3) | 1 (1) | 3 (3) | | 2 (1) | | | | 13 |
| 2011 | | 1 (1) | | 14 (7) | | 2 (2) | | | | | | 17 |
| 2012 | | 2 (2) | | 4 (2) | 30 (13) | 31 (4) | | 2 (1) | | | | 69 |
| 2013 | 9 (7) | 298 (150) | | 88 (45) | 102 (41) | 607 (217) | 5 (3) | 28 (9) | 8 (3) | | | 1,145 |
| 2014 | 60 (16) | 284 (127) | | 163 (68) | 8 (3) | 537 (115) | | | 64 (12) | 2 (2) | | 1,118 |

December 2020

Gulf of Mexico Scamp

| | | | | | | | | | | | |
|------------------|--------|-----------|-------|----------|-------|-----------|---------|-------|---------|-------|--------|
| 2015 | 16 (9) | 342 (155) | 1 (1) | 173 (79) | 1 (1) | 486 (116) | 12 (6) | | 77 (12) | | 1,108 |
| 2016 | 23 (9) | 281 (128) | | 315 (94) | 1 (1) | 516 (121) | 3 (2) | 2 (2) | 8 (2) | 1 (1) | 1,150 |
| 2017 | 21 (7) | 373 (120) | | 247 (71) | 4 (1) | 488 (122) | 54 (12) | 2 (2) | | 1 (1) | 1,190 |
| Total | 129 | 3,245 | 31 | 1,392 | 156 | 4,965 | 145 | 36 | 158 | 6 1 | 10,264 |
| Gear group total | | | 4,953 | | | | 5,146 | | 158 | 7 | 10,264 |
| Percent | | | 48.3 | | | | 50.1 | | 1.5 | 0.1 | 100.0 |

Table 3. Number of all Scamp and Yellowmouth Grouper samples aged (number of trips intercepted) from the recreational fishery listed by year, gear, and state landed.

| Gear Group | Vertical hook and line | | | | | Spears | | Total | |
|------------------|------------------------|----|-----------|--------|---------|---------|-------|-------|-------|
| | YEAR | AL | FL | LA | TX | UNKNOWN | FL | | LA |
| 1979 | | | 11 (5) | | | | | | 11 |
| 1980 | | | 26 (15) | | | | | | 26 |
| 1981 | | | 12 (4) | | | | | | 12 |
| 1986 | | | 9 (7) | | 19 (15) | 9 (9) | | | 37 |
| 1987 | | | 2 (2) | | 5 (4) | | | | 7 |
| 1988 | | | 8 (7) | | 4 (3) | | | | 12 |
| 1989 | | | 19 (12) | | | | | | 19 |
| 1990 | | | 3 (3) | | 1 (1) | | | | 4 |
| 1991 | | | 21 (18) | 3 (2) | 2 (1) | | | | 26 |
| 1992 | | | 50 (38) | 3 (3) | 9 (6) | | | | 62 |
| 1993 | | | 28 (21) | | 12 (8) | | | | 40 |
| 1994 | | | 90 (46) | 5 (3) | 18 (11) | | | 1 (1) | 114 |
| 1995 | | | 81 (40) | | 2 (2) | | | | 83 |
| 1996 | | | 155 (61) | 1 (1) | | | | | 156 |
| 1997 | | | 48 (23) | | | | 1 (1) | | 49 |
| 1998 | | | 53 (21) | | | | | | 53 |
| 1999 | | | 52 (21) | | | | | | 52 |
| 2000 | 3 (2) | | 7 (6) | 1 (1) | | | | | 11 |
| 2001 | | | 8 (6) | | | | | | 8 |
| 2002 | 1 (1) | | 77 (33) | | | | 5 | | 83 |
| 2009 | 5 (3) | | | | | | | | 5 |
| 2010 | 4 (4) | | 1 (1) | | | | | | 5 |
| 2011 | 19 (15) | | 1 (1) | | | | | | 20 |
| 2012 | | | | | 1 (1) | | | | 1 |
| 2013 | 12 (6) | | 135 (69) | 13 (3) | 15 (10) | | 2 (2) | | 177 |
| 2014 | 9 (5) | | 148 (71) | 3 (2) | 21 (13) | | | | 181 |
| 2015 | 4 (3) | | 206 (118) | | 25 (18) | | | | 235 |
| 2016 | 24 (11) | | 218 (76) | 10 (3) | 14 (11) | | | | 266 |
| 2017 | 4 (4) | | 123 (59) | | 4 (3) | | | | 131 |
| 2018 | | | 54 (40) | | | | | | 54 |
| 2019 | | | 3 (2) | | | | | | 3 |
| Total | 85 | | 1,649 | 39 | 152 | 9 | 8 | 1 | 1,943 |
| Gear group total | | | | | 1,934 | | | 9 | 1,943 |
| Percent | | | | | 99.5 | | | 0.5 | 100.0 |

Table 4. Number of Scamp and Yellowmouth Grouper samples aged from fishery-independent sources by year, gear, and state landed. Other gear types include kali pole (n=1), spear (n=7), and unknown gear type (n=1).

| Gear Group | Vertical hook and line | | | | Longline | | | | | Trap | | | Trawl | Vertical Longline | Other | Total |
|------------------|------------------------|------|----|----|----------|-----|----|----|---------|------|------|----|-------|-------------------|-------|-------|
| | AL | FL | LA | TX | AL | FL | LA | TX | Unknown | AL | FL | LA | FL | FL | FL | |
| 1980 | | | | | | | | | 1 | | | | | | | |
| 1993 | | | | | | | | | | | 2 | | | | | |
| 1994 | | 5 | | | | | | | | | | | | | | |
| 1995 | | 3 | | | | | | | | | 1 | | | | 1 | |
| 1997 | | 14 | | | | | | | | | | 1 | | | | |
| 1998 | | 2 | | | | | | | | | | | | | | |
| 1999 | | 21 | | | 1 | | | | | 3 | 3 | | | | | |
| 2000 | | 9 | | | | | | 2 | | 4 | 13 | | | | | |
| 2001 | | 20 | | | | | | | | | 3 | 2 | | | | |
| 2002 | | 4 | | | 20 | 1 | 1 | | | | 9 | | | | 7 | |
| 2006 | | | | | | 1 | | | | | 1 | | | | 1 | |
| 2007 | | | | 2 | | | 1 | | | | | | 5 | | | |
| 2008 | | | | | | | | | | | 6 | | 5 | | | |
| 2009 | | 50 | | | | | | | | | 34 | | 9 | | | |
| 2010 | | 180 | | | | | | | | | 6 | | 6 | 6 | | |
| 2011 | | 21 | | | | | 2 | | | | 27 | | 1 | | | |
| 2012 | | 5 | | | | | | | | | 35 | | 2 | | | |
| 2013 | | 75 | | | | | 16 | | | | 23 | | 6 | 23 | | |
| 2014 | | 8 | 2 | | | | | | | | 14 | | 5 | | | |
| 2015 | | 12 | 1 | | | | | | | | 38 | | 6 | | | |
| 2016 | 1 | 38 | 1 | | 1 | 2 | | | | | 1 | | 8 | 4 | | |
| 2017 | 1 | 31 | 4 | 1 | 1 | | | | | | 8 | | 2 | 2 | | |
| 2018 | | 46 | | | | | | | | | 6 | | 2 | 7 | | |
| Total | 2 | 544 | 8 | 3 | 23 | 22 | 2 | 2 | 1 | 7 | 230 | 3 | 57 | 42 | 9 | 955 |
| Gear group total | | 557 | | | | 50 | | | | | 240 | | 57 | 42 | 9 | 955 |
| Percent | | 58.3 | | | | 5.2 | | | | | 25.1 | | 6.0 | 4.4 | 0.9 | 100.0 |

Table 6. Number of Scamp samples with left otolith weight and observed age recorded and used in otolith weight – age linear regression models to provide a temporary proxy age for years 2003–2012 (i.e., years when the Benetec saw was used by Panama City Lab to section Scamp otoliths).

| Year | Number of observed ages with otolith weight recorded |
|-------|--|
| 1980 | 8 |
| 1981 | 92 |
| 1986 | 6 |
| 1987 | 3 |
| 1988 | 5 |
| 1989 | 9 |
| 1990 | 2 |
| 1991 | 87 |
| 1999 | 128 |
| 2000 | 168 |
| 2001 | 711 |
| 2002 | 1,393 |
| 2013 | 371 |
| 2014 | 442 |
| 2015 | 1,038 |
| 2016 | 418 |
| 2017 | 574 |
| Total | 5,455 |

Table 7. Results from simple linear regression models for Scamp age regressed on left otolith weight that provided a proxy of age that could be used temporarily for the landings age compositions for years 2003–2012 (i.e., years for which the Benetec saw was used by Panama City Lab to section Scamp otoliths). Model shaded in gray represents the linear regression model recommended by the LHG.

| Model | | Estimate | SE | t | Pr(> t) | Df | F-stat | R ² | Adj. R ² | p |
|--------------------------------------|---------------------|----------|--------|---------|----------|------|--------|----------------|---------------------|--------|
| Calendar age ~ left otolith weight | Intercept | 0.8154 | 0.1023 | 7.968 | <0.001 | 1 | 10630 | 0.6609 | 0.6608 | <0.001 |
| | Left otolith weight | 67.8105 | 0.6578 | 103.083 | <0.001 | 5453 | | | | |
| Fractional age ~ left otolith weight | Intercept | 1.0203 | 0.1018 | 10.02 | <0.001 | 1 | 10770 | 0.6639 | 0.6638 | <0.001 |
| | Left otolith weight | 67.9330 | 0.6546 | 103.78 | <0.001 | 5453 | | | | |

Table 8. Number of Gulf of Mexico Scamp and Yellowmouth Grouper samples with fractional ages and fork length shown by year and used in the population growth model. Note that samples shown for years 2003–2012 (i.e., years for which the Benetec saw was used by Panama City Lab to section Scamp otoliths) include all Yellowmouth Grouper age samples ($n = 175$) and only Scamp ages that were provided by FWRI and GulfFIN ($n = 426$).

| Year | SEDAR 68 |
|-------|----------|
| 1972 | 6 |
| 1973 | 5 |
| 1977 | 36 |
| 1978 | 23 |
| 1979 | 203 |
| 1980 | 140 |
| 1981 | 114 |
| 1986 | 39 |
| 1987 | 7 |
| 1988 | 12 |
| 1989 | 19 |
| 1990 | 3 |
| 1991 | 253 |
| 1992 | 168 |
| 1993 | 346 |
| 1994 | 240 |
| 1995 | 201 |
| 1996 | 222 |
| 1997 | 89 |
| 1998 | 120 |
| 1999 | 176 |
| 2000 | 211 |
| 2001 | 1,133 |
| 2002 | 1,703 |
| 2003 | 8 |
| 2004 | 14 |
| 2005 | 3 |
| 2006 | 13 |
| 2007 | 19 |
| 2008 | 17 |
| 2009 | 111 |
| 2010 | 216 |
| 2011 | 88 |
| 2012 | 112 |
| 2013 | 1,466 |
| 2014 | 1,327 |
| 2015 | 1,407 |
| 2016 | 1,471 |
| 2017 | 1,373 |
| 2018 | 116 |
| 2019 | 3 |
| Total | 13,233 |

Table 9. Gulf of Mexico Scamp and Yellowmouth Grouper growth model parameters for the population and growth model parameters for females and males combined. All parameter estimates are shown with \pm standard deviation. Only fish that were histologically identified as functional females and males were used in the female+male growth models. Growth models shaded in gray represent the population growth models that were recommended by the LHG. Inverse weighting was used in all growth models. AIC = Akaike Information Criterion.

| Model Type | Growth Model | Number of observations | Number of parameters | Objective function | L_{inf} (FL, cm) \pm std. dev | K \pm std. dev | t_0 \pm std. dev | Varpar[1]. \pm std. dev. | Varpar[2]. \pm std. dev. | AIC |
|---------------|--|------------------------|----------------------|--------------------|---|----------------------|-------------------------|-------------------------------|-------------------------------|--------|
| Population | Constant Sigma | 13,233 | 4 | 129.785 | 71.800 \pm 3.243 | 0.112 \pm 0.030 | -2.410 \pm 1.452 | 8.011 \pm 0.956 | | 267.57 |
| Population | Constant CV | 13,233 | 4 | 127.210 | 70.222 \pm 2.610 | 0.134 \pm 0.024 | -1.762 \pm 0.575 | 0.130 \pm 0.016 | | 262.42 |
| Population | Estimate CV as linear function of age | 13,233 | 5 | 127.147 | 69.752 \pm 2.918 | 0.139 \pm 0.028 | -1.689 \pm 0.560 | 0.118 \pm 0.034 | 0.140 \pm 0.034 | 264.29 |
| Population | Estimate CV as linear function of size | 13,233 | 5 | 127.147 | 69.808 \pm 2.808 | 0.139 \pm 0.029 | -1.675 \pm 0.559 | 0.108 \pm 0.060 | 0.134 \pm 0.021 | 264.29 |
| Female + Male | Constant Sigma | 1,931 | 4 | 87.244 | 69.190 \pm 2.874 | 0.138 \pm 0.034 | -1.759 \pm 1.223 | 5.909 \pm 0.802 | | 182.49 |
| Female + Male | Constant CV | 1,931 | 4 | 87.431 | 68.446 \pm 2.924 | 0.146 \pm 0.031 | -1.638 \pm 0.773 | 0.107 \pm 0.015 | | 182.86 |
| Female + Male | Estimate CV as linear function of age | 1,931 | 5 | 86.702 | 68.714 \pm 2.512 | 0.144 \pm 0.030 | -1.628 \pm 0.851 | 0.138 \pm 0.035 | 0.059 \pm 0.036 | 183.40 |
| Female + Male | Estimate CV as linear function of size | 1,931 | 5 | 86.848 | 69.027 \pm 2.836 | 0.141 \pm 0.031 | -1.680 \pm 0.929 | 0.166 \pm 0.070 | 0.090 \pm 0.019 | 183.70 |

Table 10. Parameter estimates for Scamp maturity and transition regression models. Four different link functions (probit, logit, cauchit, and cloglog) were specified, and parameter values for the best-fitting model (as determined by AIC) are displayed here, along with model weight for the best-fitting model (mod_weight) and sample size (N). The inflection point, a derived parameter (intercept/slope) are also shown (i.e., A₅₀ for age and L₅₀ for length).

| Model | Link Fct | Mod_weight | N | Parameter | Estimate | Std Error |
|---------------------------|----------|------------|-------|-----------------|----------|-----------|
| Female maturity at age | logit | 0.945 | 413 | Intercept | - | 7.31E-01 |
| | | | | slope | 4.55E+00 | 1.79E-01 |
| | | | | A ₅₀ | 1.33E+00 | 3.41 |
| Female maturity at length | probit | 0.465 | 763 | Intercept | - | 8.50E-01 |
| | | | | slope | 7.90E+00 | 2.13E-03 |
| | | | | L ₅₀ | 2.17E-02 | 363.7 |
| Transition at age | probit | 0.888 | 1,937 | Intercept | - | 9.48E-02 |
| | | | | slope | 2.15E+00 | 9.81E-03 |
| | | | | A ₅₀ | 1.99E-01 | 10.8 |
| Transition at length | logit | 1 | 4,412 | Intercept | - | 3.05E-01 |
| | | | | slope | 9.48E+00 | 5.65E-04 |
| | | | | L ₅₀ | 1.71E-02 | 555.6 |

Table 11. Natural mortality (M) vectors based on Lorenzen (1996) and scaled to Then et al. (2015) Serranidae data for maximum age for both stocks of Scamp and Yellowmouth Grouper ($M = 0.155$). Size-at-Age was calculated on the mid-point of the age (e.g., 0 = 0.5, 1 = 1.5, etc.)

| Age | M - SA | M - GOM |
|-----|----------|-----------|
| 0 | 0.486 | 0.567 |
| 1 | 0.382 | 0.432 |
| 2 | 0.325 | 0.359 |
| 3 | 0.288 | 0.314 |
| 4 | 0.264 | 0.283 |
| 5 | 0.246 | 0.261 |
| 6 | 0.232 | 0.244 |
| 7 | 0.222 | 0.231 |
| 8 | 0.214 | 0.221 |
| 9 | 0.207 | 0.213 |
| 10 | 0.202 | 0.207 |
| 11 | 0.198 | 0.201 |
| 12 | 0.194 | 0.197 |
| 13 | 0.191 | 0.193 |
| 14 | 0.189 | 0.190 |
| 15 | 0.187 | 0.187 |
| 16 | 0.185 | 0.185 |
| 17 | 0.183 | 0.183 |
| 18 | 0.182 | 0.181 |
| 19 | 0.181 | 0.180 |
| 20 | 0.180 | 0.179 |
| 21 | 0.180 | 0.177 |
| 22 | 0.179 | 0.177 |
| 23 | 0.178 | 0.176 |
| 24 | 0.178 | 0.175 |
| 25 | 0.177 | 0.174 |
| 26 | 0.177 | 0.174 |
| 27 | 0.177 | 0.174 |
| 28 | 0.177 | 0.173 |
| 29 | 0.176 | 0.173 |
| 30 | 0.176 | 0.172 |
| 31 | 0.176 | 0.172 |
| 32 | 0.176 | 0.172 |
| 33 | 0.176 | 0.172 |
| 34 | 0.176 | 0.172 |

Table 12. Meristic conversion equations for Gulf of Mexico Scamp and Yellowmouth Grouper.

a. Length – length equations

| Model: $Y = a + bX$ | n | a | SE | b | SE | r² | Units | range of Independent variable |
|-------------------------------|----------|----------|-----------|----------|-----------|----------------------|--------------|--------------------------------------|
| FL = Natural TL | 3,205 | 1.77 | 0.10 | 0.89 | 0.000 | 0.99 | cm, cm | 16.7 – 97.6 |
| Natural TL = FL | 3,205 | -1.29 | 0.11 | 1.11 | 0.000 | 0.99 | cm, cm | 16.0 – 94.4 |
| Natural TL = maxTL | 520 | -0.28 | 0.14 | 0.99 | 0.000 | 0.996 | cm, cm | 32.5 – 100.1 |
| maxTL = Natural TL | 520 | 0.46 | 0.14 | 1.01 | 0.000 | 0.996 | cm, cm | 31.2 – 97.6 |
| FL = maxTL | 2,994 | 2.30 | 0.07 | 0.87 | 0.000 | 0.99 | cm, cm | 18.7 – 100.1 |
| maxTL = FL | 2,994 | -2.28 | 0.09 | 1.14 | 0.000 | 0.99 | cm, cm | 17.8 – 94.4 |
| FL = SL | 3,042 | 1.95 | 0.08 | 1.12 | 0.000 | 0.99 | cm, cm | 14.6 – 79.8 |
| SL = FL | 3,042 | -1.34 | 0.08 | 0.88 | 0.000 | 0.99 | cm, cm | 17.8 – 94.4 |
| Natural TL = SL | 606 | 0.36 | 0.34 | 1.25 | 0.000 | 0.97 | cm, cm | 24.7 – 79.8 |
| SL = Natural TL | 606 | 0.76 | 0.27 | 0.78 | 0.000 | 0.97 | cm, cm | 26.0 – 97.6 |
| maxTL = SL | 3,258 | -0.05 | 0.10 | 1.28 | 0.000 | 0.99 | cm, cm | 13.9 – 79.8 |
| SL = maxTL | 3,258 | 0.48 | 0.08 | 0.77 | 0.000 | 0.99 | cm, cm | 17.5 – 100.1 |

- b. Whole weight – length equations. LN transformed weight and length for linear regression analyses. Equations converted to power equation including ½ MSE for transformation bias.

| Model: $Y = a + bX$ | n | a | SE | b | SE | r² | Units | range of Independent variable | MSE | Power Equation: $Y = a(X)^b$ |
|---------------------------------------|----------|----------|-----------|----------|-----------|----------------------|--------------|--------------------------------------|------------|--|
| Ln(WW) = Ln(FL) | 12,660 | -10.92 | 0.03 | 2.94 | 0.01 | 0.92 | kg, cm | 16.0 – 124.0 | 0.03 | WW = 1.83E-05(FL) ^{2.94} |
| Ln(FL) = Ln(WW) | 12,660 | 3.73 | 0.00 | 0.31 | 0.00 | 0.92 | kg, cm | 0.053 – 29.93 | 0.0035 | FL = 41.75(WW) ^{0.31} |
| Ln(WW) = Ln(Natural TL) | 3,059 | -11.00 | 0.06 | 2.90 | 0.02 | 0.92 | kg, cm | 16.7 – 117.6 | 0.04 | WW = 1.70E-05(Natural TL) ^{2.90} |
| Ln(Natural TL) = Ln(WW) | 3,059 | 3.80 | 0.00 | 0.32 | 0.00 | 0.92 | kg, cm | 0.053 – 16.82 | 0.0045 | Natural TL = 44.80(WW) ^{0.32} |
| Ln(WW) = Ln(maxTL) | 1,972 | -10.97 | 0.05 | 2.88 | 0.01 | 0.96 | kg, cm | 23.0 – 100.1 | 0.01 | WW = 1.73E-05(maxTL) ^{2.88} |
| Ln(maxTL) = Ln(WW) | 1,972 | 3.82 | 0.00 | 0.33 | 0.00 | 0.96 | kg, cm | 0.13 – 10.14 | 0.0015 | maxTL = 45.64(WW) ^{0.33} |
| Ln(WW) = Ln(SL) | 2,092 | -10.3 | 0.04 | 2.89 | 0.01 | 0.97 | kg, cm | 17.7 – 79.8 | 0.013 | WW = 3.39E-05(SL) ^{2.89} |
| Ln(SL) = Ln(WW) | 2,092 | 3.57 | 0.00 | 0.33 | 0.00 | 0.97 | kg, cm | 0.13 – 10.14 | 0.0014 | SL = 35.54(WW) ^{0.33} |

- c. Gutted weight – length equations. LN transformed weight and length for linear regression analyses. Equations converted to power equation including ½ MSE for transformation bias.

| Model: $Y = a + bX$ | n | a | SE | b | SE | r ² | Units | range of Independent variable | MSE | Power Equation: $Y = a(X)^b$ |
|--------------------------|--------|--------|------|------|------|----------------|--------|-------------------------------|-------|---|
| Ln(GW) = Ln(FL) | 30,798 | -11.35 | 0.02 | 3.04 | 0.00 | 0.94 | kg, cm | 22.0 – 117.0 | 0.016 | GW = 1.19E-05(FL) ^{3.04} |
| Ln(FL) = Ln(GW) | 30,798 | 3.75 | 0.00 | 0.31 | 0.00 | 0.94 | kg, cm | 0.050 – 25.58 | 0.002 | FL = 42.56(GW) ^{0.31} |
| Ln(GW) = Ln(Natural TL) | 617 | -11.75 | 0.18 | 3.08 | 0.05 | 0.88 | kg, cm | 26.7 – 99.0 | 0.074 | GW = 8.19E-06(Natural TL) ^{3.08} |
| Ln(Natural TL) = Ln(GW) | 617 | 3.83 | 0.00 | 0.29 | 0.00 | 0.88 | kg, cm | 0.05 – 10.35 | 0.007 | Natural TL = 46.22(GW) ^{0.32} |
| Ln(GW) = Ln(maxTL) | 1,156 | -10.94 | 0.08 | 2.86 | 0.02 | 0.95 | kg, cm | 34.8 – 87.1 | 0.009 | GW = 1.78E-05(maxTL) ^{2.86} |
| Ln(maxTL) = Ln(GW) | 1,156 | 3.83 | 0.00 | 0.33 | 0.00 | 0.95 | kg, cm | 0.48 – 8.11 | 0.001 | maxTL = 46.09(GW) ^{0.33} |
| Ln(GW) = Ln(SL) | 1,131 | -10.55 | 0.07 | 2.95 | 0.02 | 0.96 | kg, cm | 27.4 – 70.8 | 0.007 | GW = 2.63E-05(SL) ^{2.95} |
| Ln(SL) = Ln(GW) | 1,131 | 3.58 | 0.00 | 0.33 | 0.00 | 0.96 | kg, cm | 0.45 – 8.62 | 0.001 | SL = 35.89(GW) ^{0.33} |

- d. Whole weight – gutted weight, and gutted weight – whole weight conversions.

| Model: WW = GW (no intercept; $Y = bX$) | N | B | SE | R ² | Units | Range of Independent variable |
|--|-----|------|----|----------------|--------|-------------------------------|
| South Atlantic | 172 | 1.07 | 0 | 0.9977 | kg, kg | 0.129 – 7.1 |
| Gulf of Mexico | 230 | 1.03 | 0 | 0.9981 | kg, kg | 0.19 – 4.75 |
| Southeast Region | 402 | 1.05 | 0 | 0.9946 | kg, kg | 0.129 – 7.1 |
| | | | | | | |
| Model: GW = WW (no intercept; $Y = bX$) | | | | | | |
| Gulf of Mexico | 396 | 0.95 | 0 | 0.9987 | kg, kg | 0.136 – 7.8 |

2.10 FIGURES

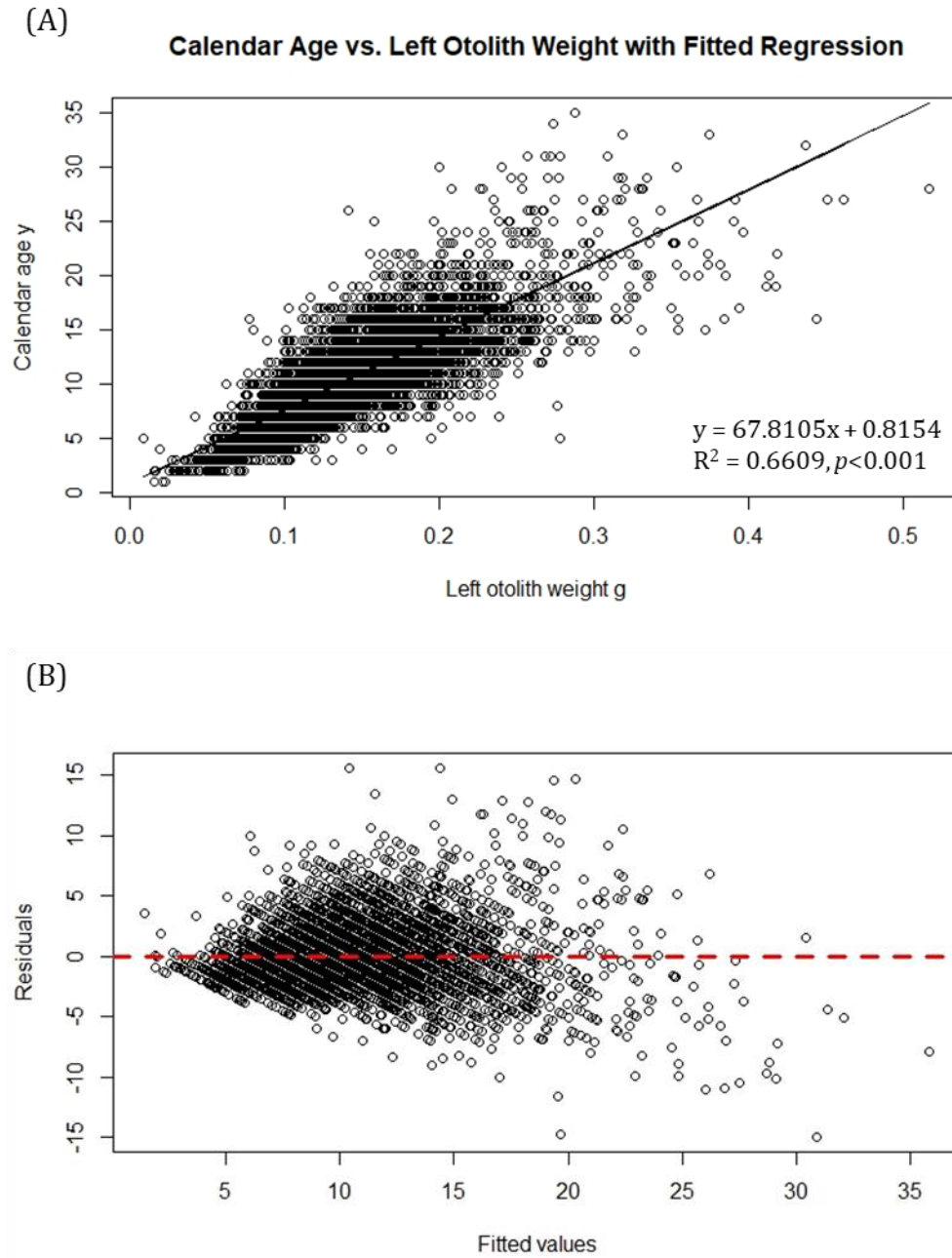
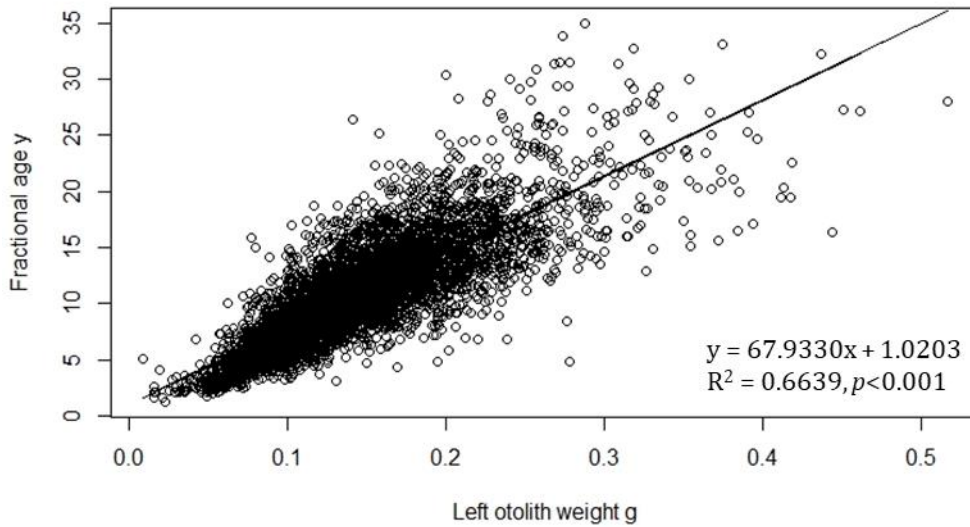

Figure 1. Plots showing the (A) simple linear regression model calendar age (years) regressed on left otolith weight (grams), and (B) residuals versus fitted values from the linear regression. The LHG recommended using this linear regression model to produce a proxy of age that could be used temporarily for the landings age compositions for years 2003–2012 (years for which the Benetec saw was used to section Scamp otoliths).

(A)

Fractional Age vs. Left Otolith Weight with Fitted Regression



(B)

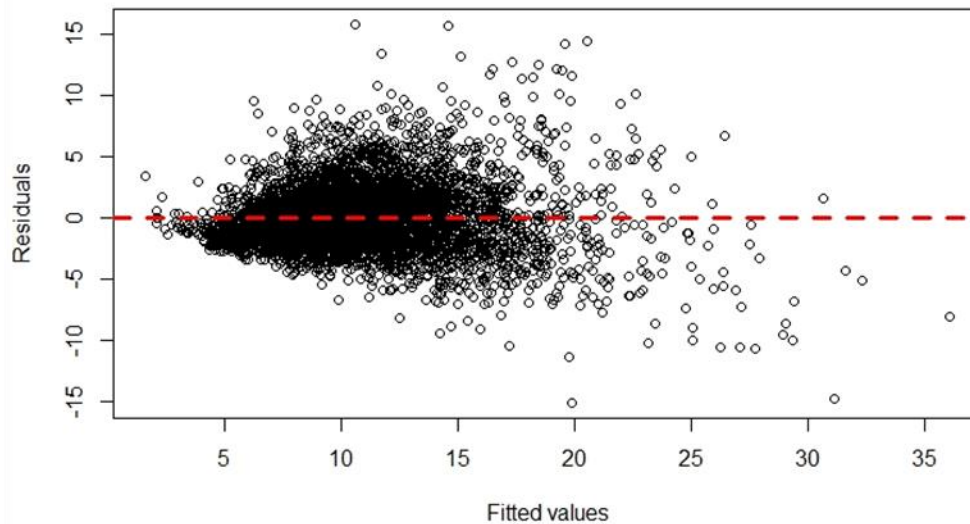

Figure 2. Plots showing the (A) simple linear regression model fractional age (years) regressed on left otolith weight (grams), and (B) residuals versus fitted values from the linear regression model.

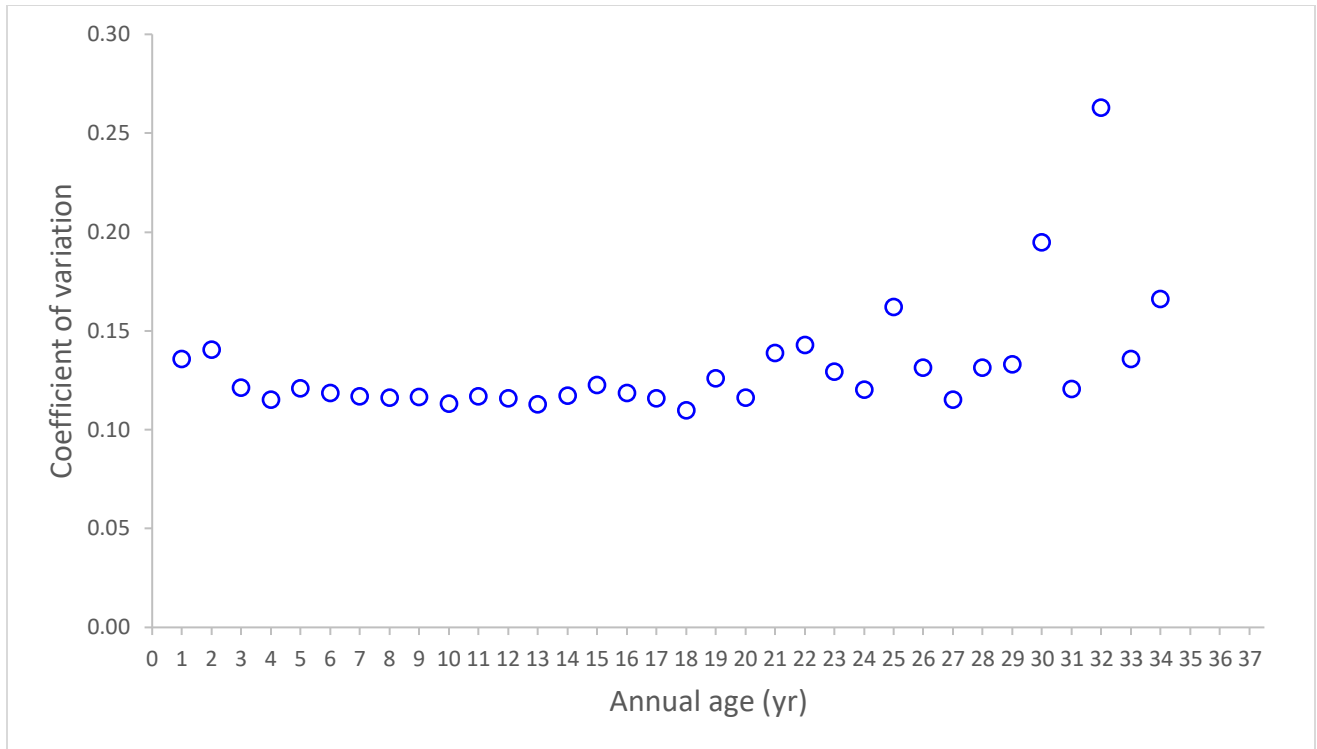

Figure 3. Variance structure for observed size-at-age data for Scamp and Yellowmouth Grouper from the U.S. Gulf of Mexico (1972–2019) showing the coefficient of variation at length for each age group ($n = 13,233$).

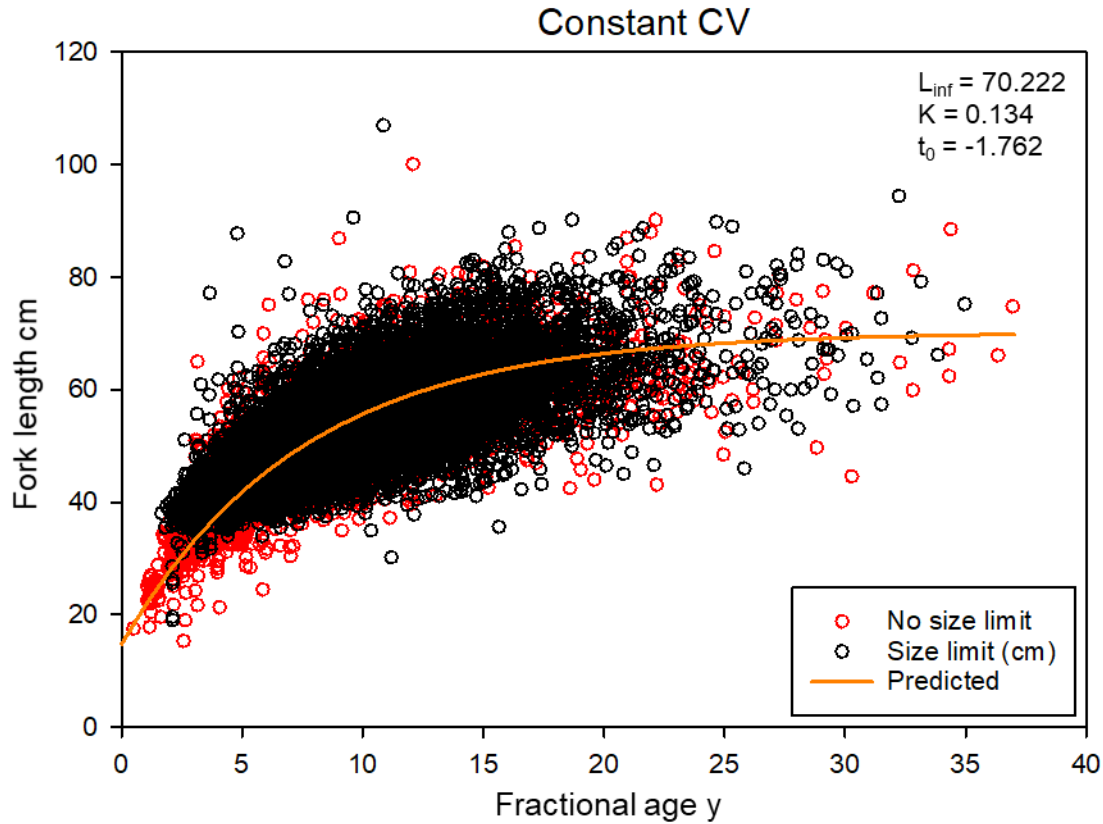

Figure 4. Population growth model for Gulf of Mexico Scamp and Yellowmouth Grouper ($n = 13,233$) using fractional age at fork length (cm) with correction for left truncated distribution of size-at-age under minimum size regulations, inverse weighted by sample size at calendar age, and assuming a constant CV across all ages. Von Bertalanffy growth parameters are shown on figure, and L_{inf} units are in cm.

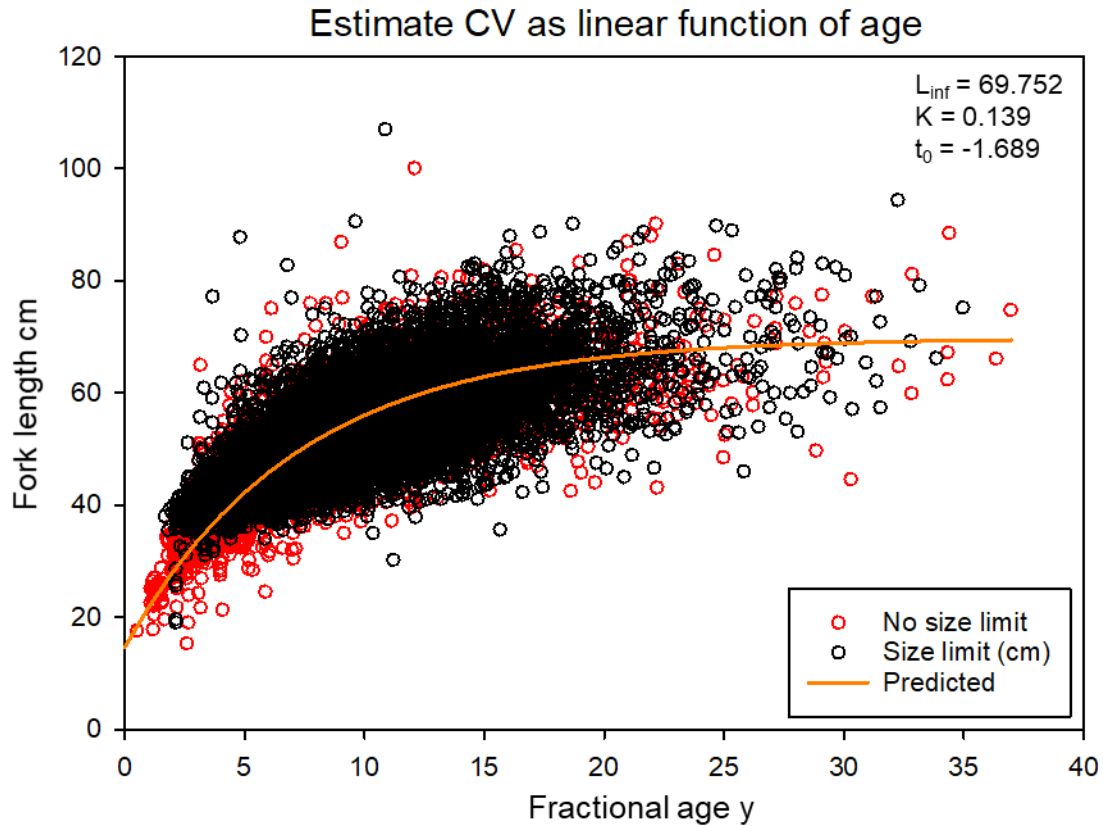

Figure 5. Population growth model for Gulf of Mexico Scamp and Yellowmouth Grouper ($n = 13,233$) using fractional age at fork length (cm) with correction for left truncated distribution of size-at-age under minimum size regulations, inverse weighted by sample size at calendar age, and assuming a variance structure of estimating CV as a linear function of age across all ages. Von Bertalanffy growth parameters are shown on figure, and L_{inf} units are in cm.

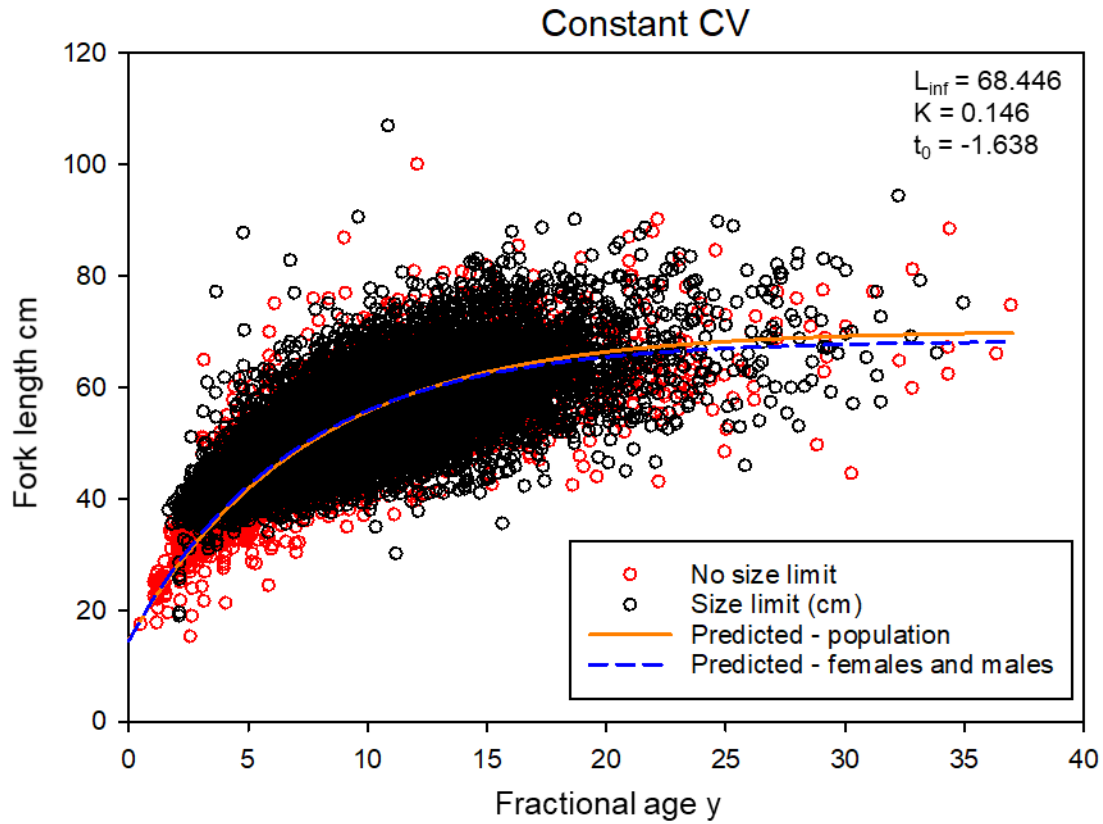

Figure 6. Population growth model for Gulf of Mexico Scamp and Yellowmouth Grouper ($n = 13,233$) using fractional age at fork length (cm) with correction for left truncated distribution of size-at-age under minimum size regulations, inverse weighted by sample size at calendar age, and assuming a constant CV across all ages. Growth model for females and males combined together ($n = 1,931$) is overlain on the population growth model. Von Bertalanffy growth parameters are shown on figure, and L_{inf} units are in cm.

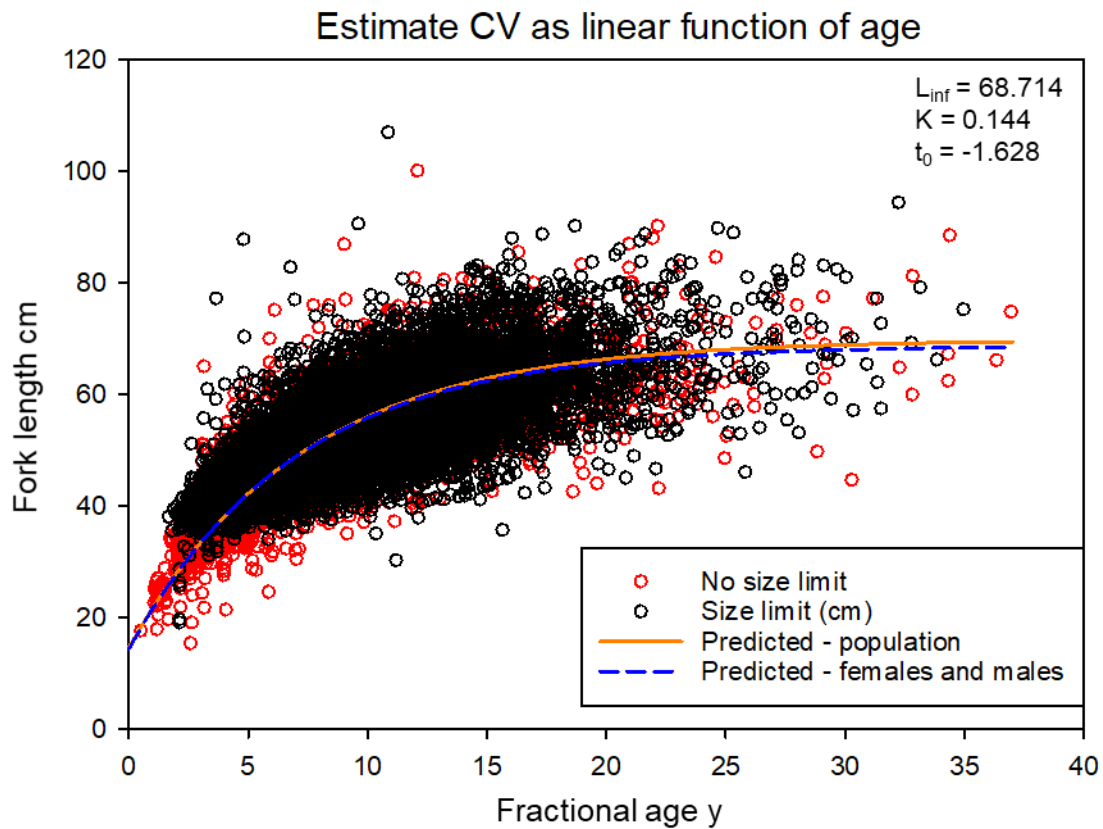

Figure 7. Population growth model for Gulf of Mexico Scamp and Yellowmouth Grouper ($n = 13,233$) using fractional age at fork length (cm) with correction for left truncated distribution of size-at-age under minimum size regulations, inverse weighted by sample size at calendar age, and assuming a variance structure of estimating CV as a linear function of age across all ages. Growth model for females and males combined together ($n = 1,931$) is overlain on the population growth model. Von Bertalanffy growth parameters are shown on figure, and L_{inf} units are in cm.

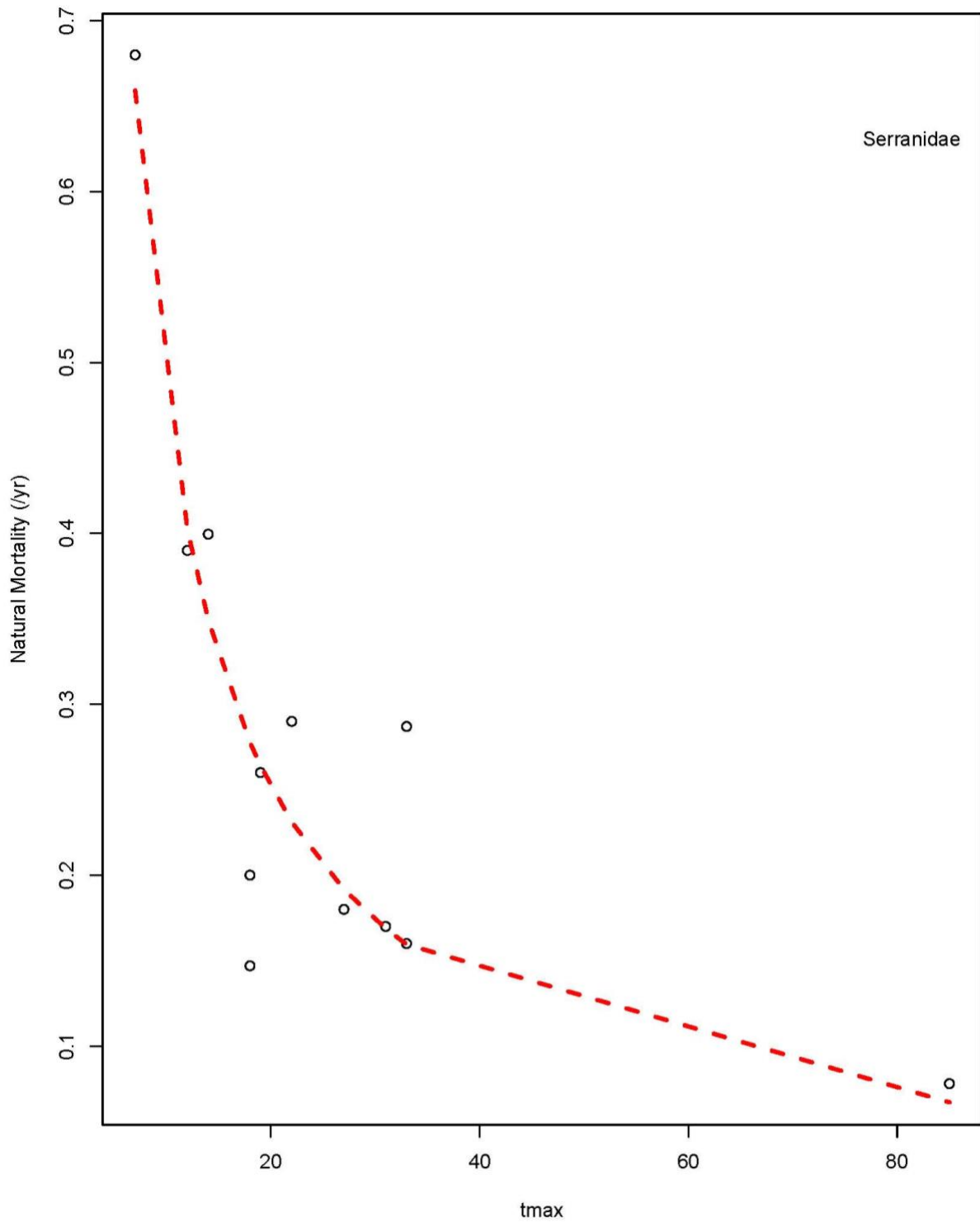

Figure 8. Values of M estimated for Serranids (Groupers) from Then et al. (2015) data set and regression line.

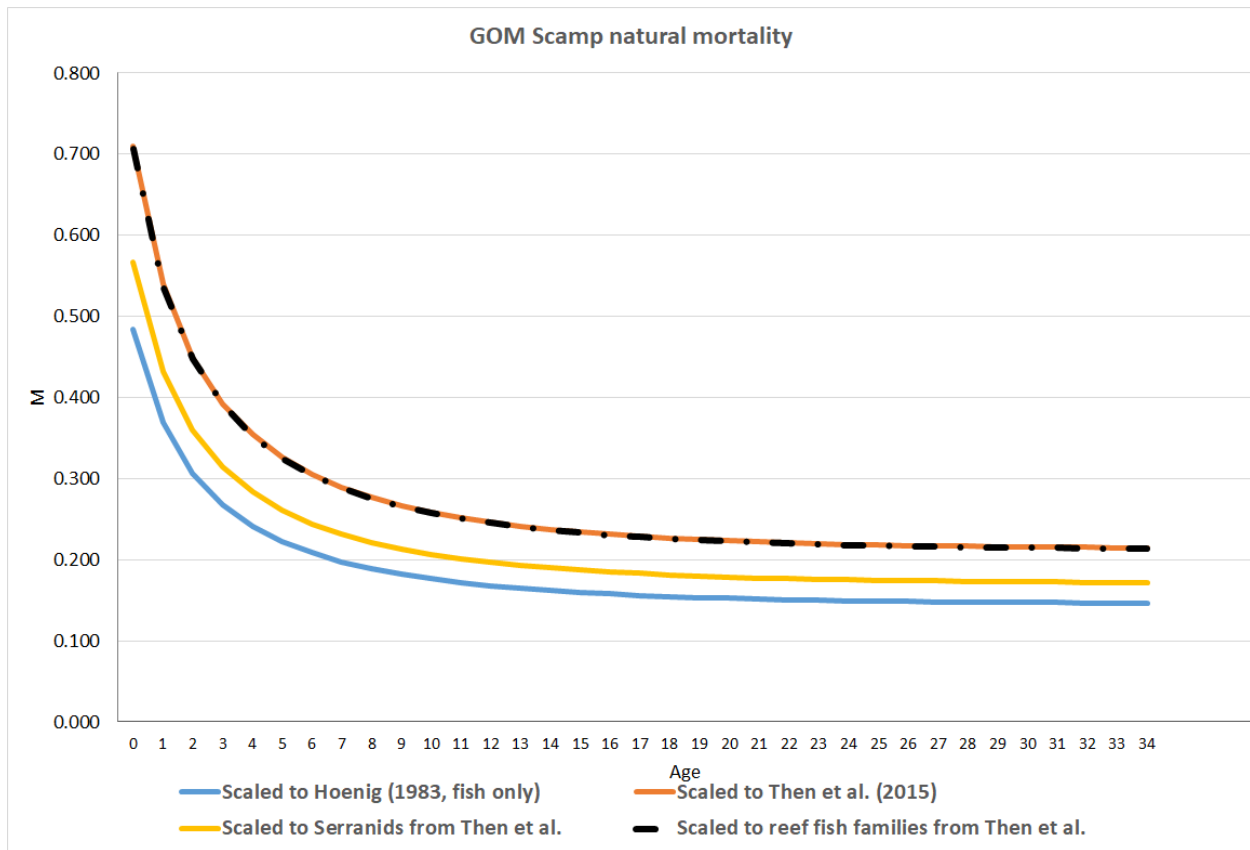

Figure 9. Natural mortality (M) vector for Gulf of Mexico Scamp and Yellowmouth Grouper. Lorenzen size-at-age natural mortality scaled to point estimates of M based on maximum age in the population, age 34. Recommended values (yellow) are the ones scaled to the point estimate of M based on the Serranidae data used in Then et al. (2015).

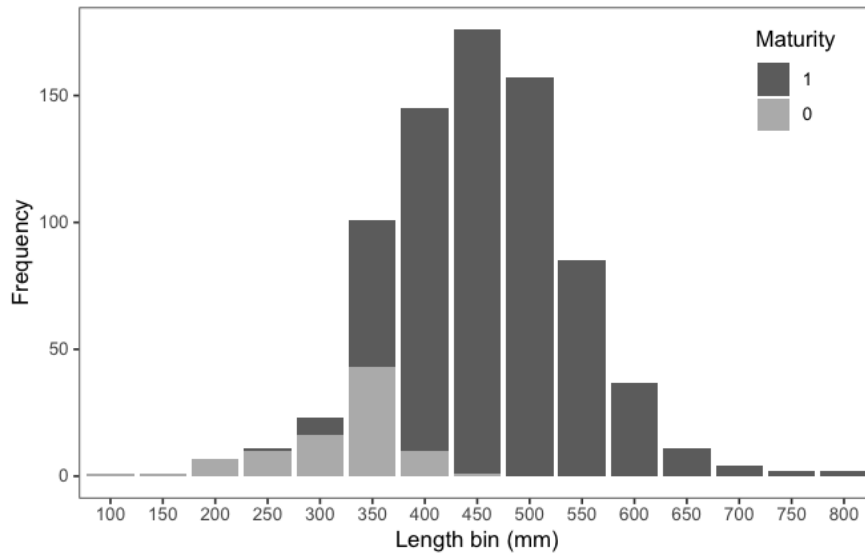

Figure 10. Frequency distributions of immature (light grey) versus mature (dark grey) females for fork length. Mature females shown here included only individuals assigned as spawning capable. 0 = Immature, 1 = Mature.

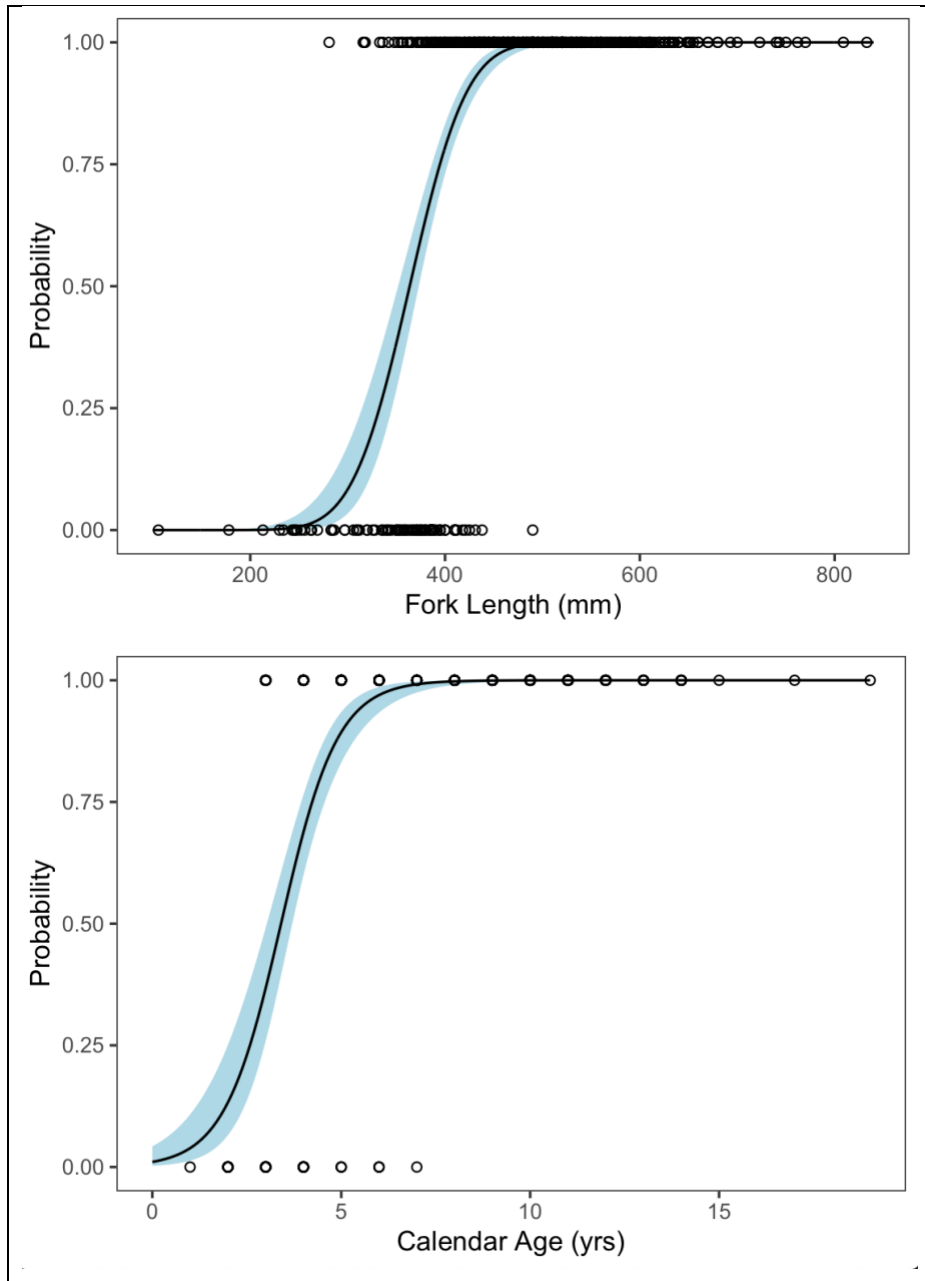

Figure 11. Observed and predicted length (top) and age (bottom) at maturity with 95% confidence intervals. The estimated size at 50% maturity under the best-fitting model (probit) was 363.7 mm FL, and the estimated age at 50% maturity under the best-fitting model (logit) was 3.41 years.

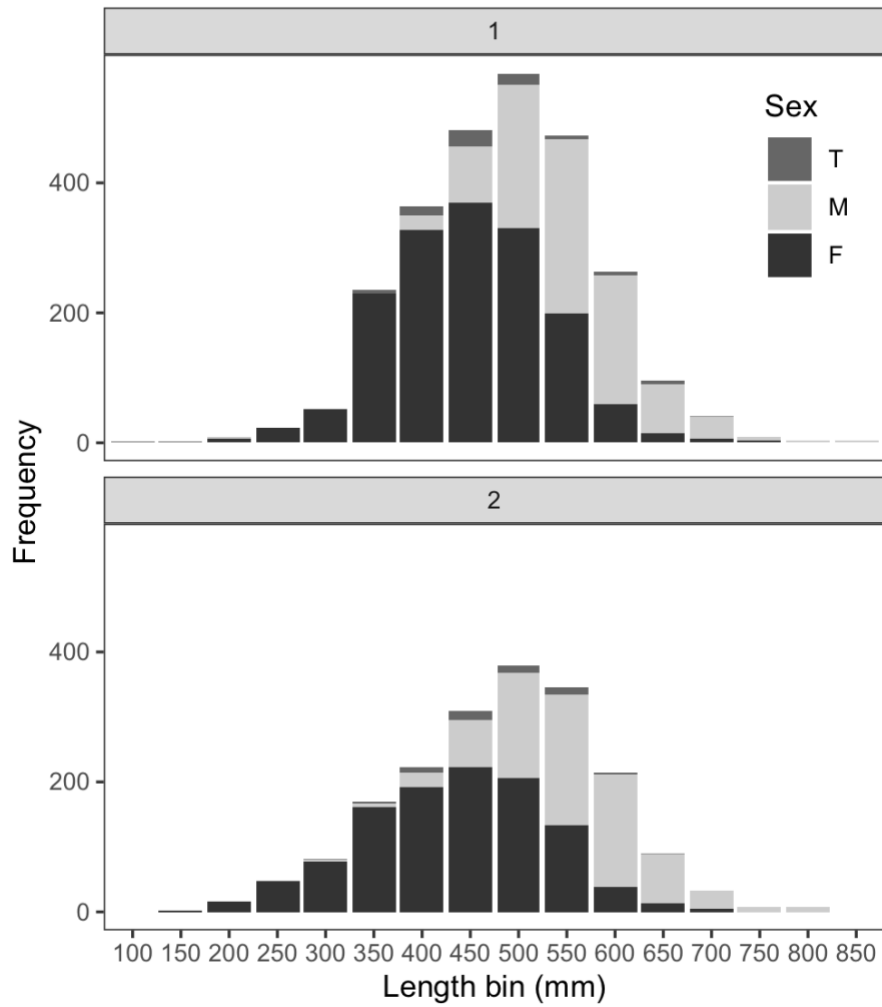

Figure 12. Length frequency distribution by sex (F = female, M = male, T = transitional). The male sex ratio has increased from 36% in the early period (period 1, 1972–2002) to 41% in more recent years (period 2, 2003–2017).

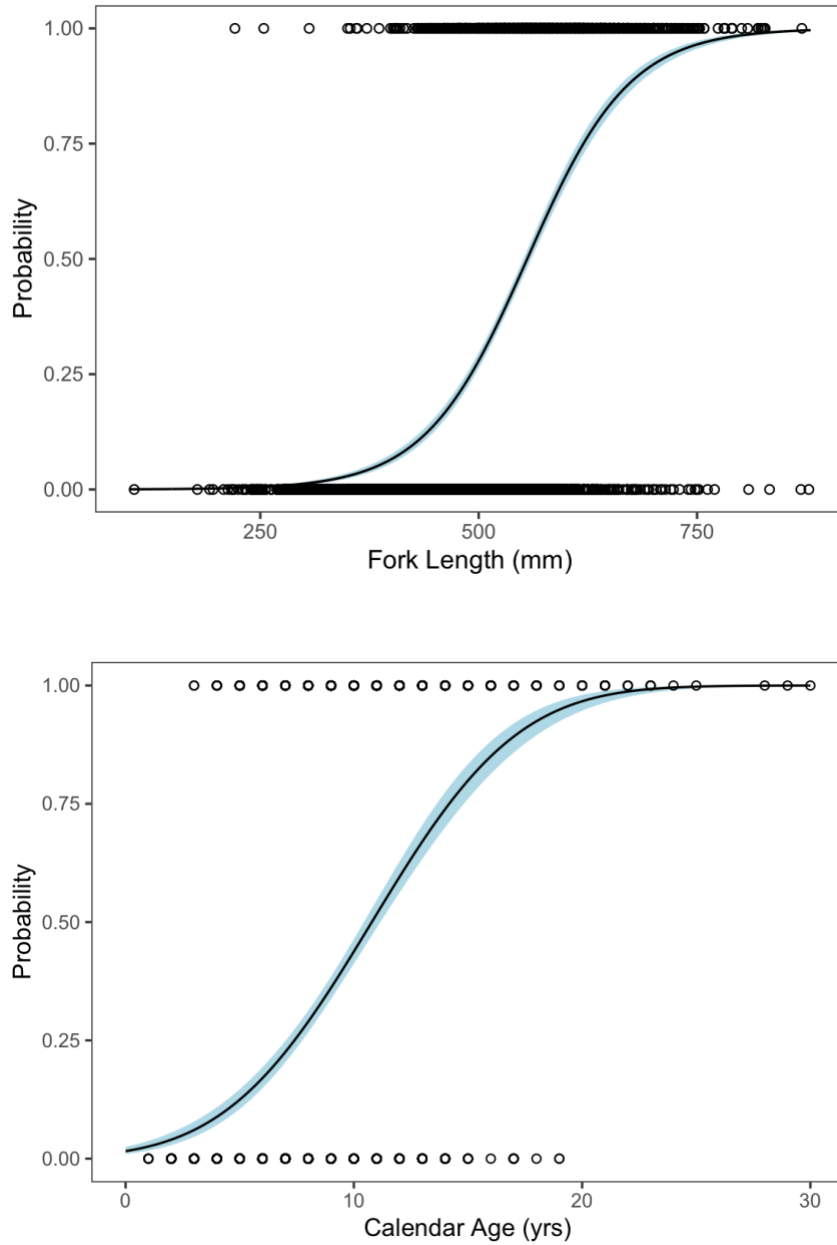

Figure 13. Observed and predicted length (top) and age (bottom) at transition with 95% confidence intervals. Estimated size at 50% male under the best-fitting model (logit) was 555.6 mm FL, and estimated age at 50% male under the best-fitting model (probit) was 10.8 years.

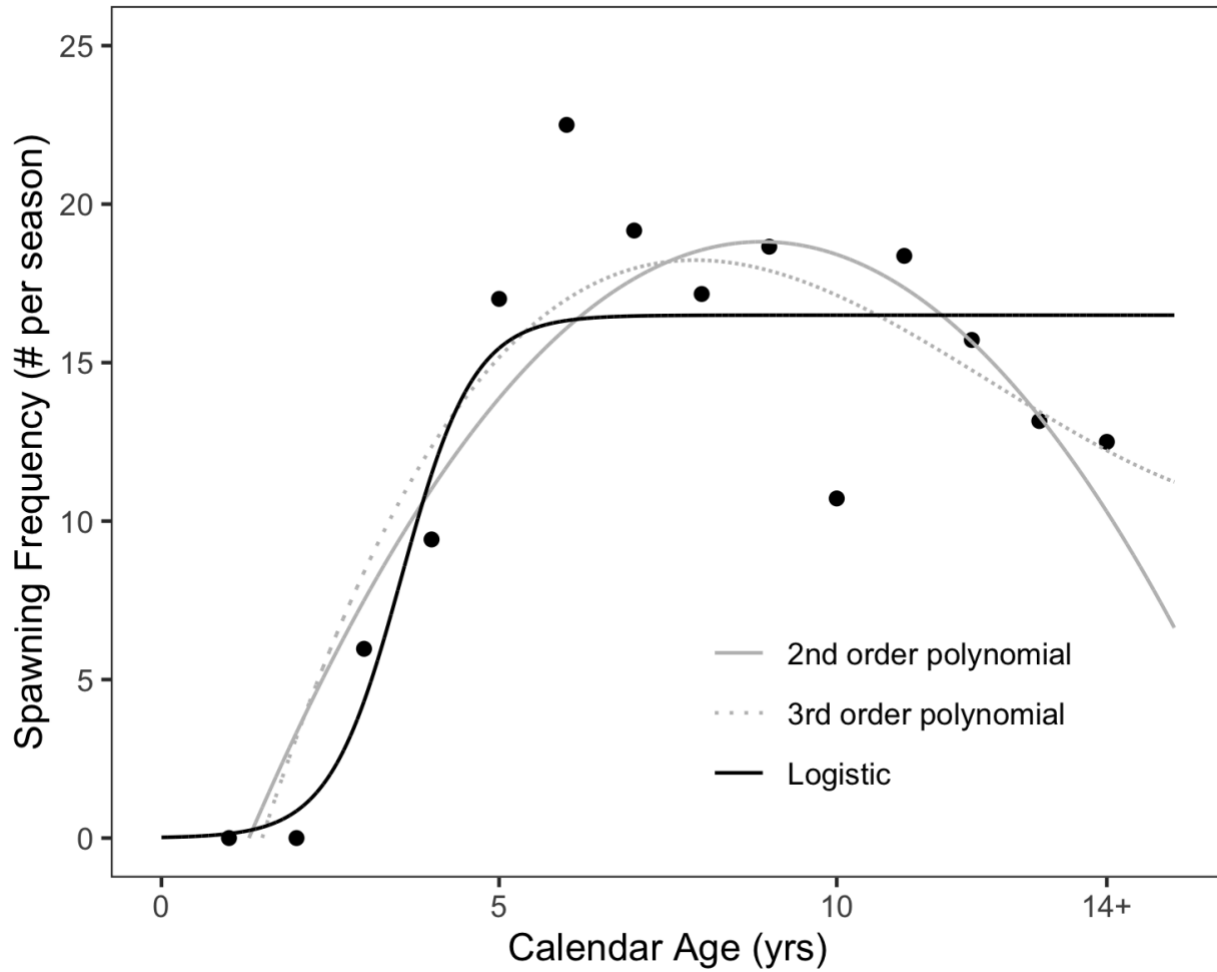

Figure 14. Estimated spawning frequency at age (filled circles) and the three best-fitting models for the base spawning season length of 100 days. The logistic provided the best fit (black line), followed by a second-order polynomial (grey solid line) which was a marginally better fit compared to the third order polynomial (dotted grey line). Ages 14 through 19 were pooled. Spawning frequency was estimated using all (mature and immature) females with available age information.

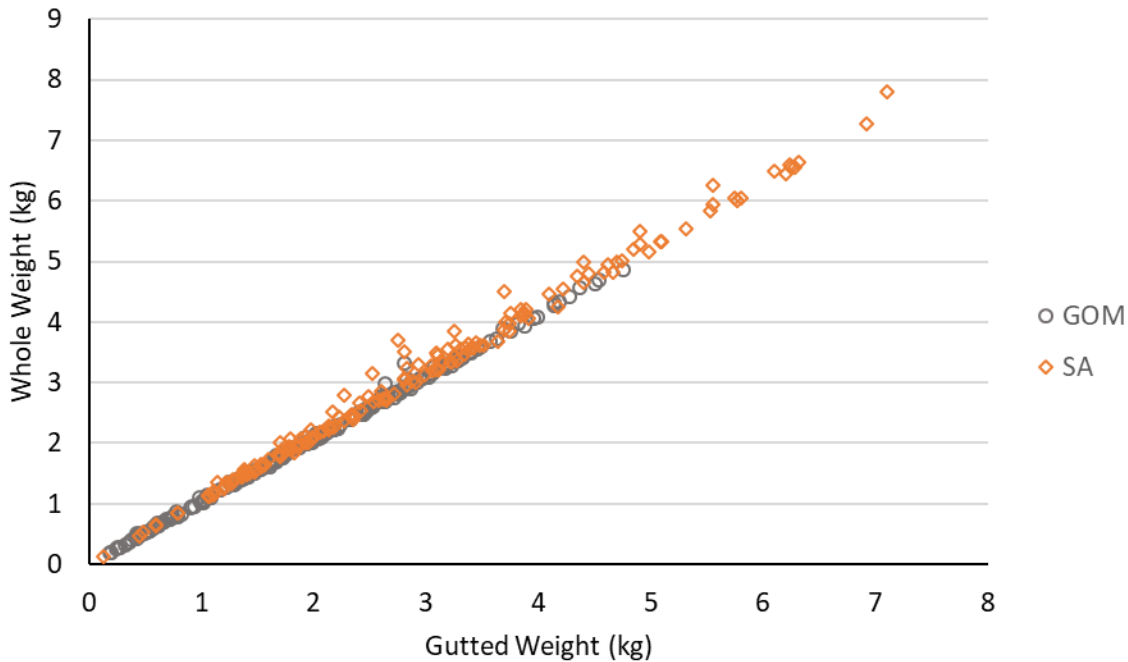

Figure 15. Scamp and Yellowmouth Grouper whole weight – gutted weight data for the entire Southeast region.

3 COMMERCIAL FISHERY STATISTICS

3.1 OVERVIEW

Commercial landings for the US Gulf of Mexico Scamp and Yellowmouth Grouper stock were developed in gutted weight pounds for the period 1962-2018 based on federal and state trip ticket databases. The SEDAR 68 Stock ID Workshop established the South Atlantic and Gulf of Mexico Council boundary line as the delimiting stock boundary between stocks. The Stock Identification Workshop also recommended that, Scamp and Yellowmouth be combined for the U.S. Gulf of Mexico (see section 3.3.3 on Scamp/Yellowmouth Groupers Misidentification). From now on when referring to the “landings”, both Scamp and Yellowmouth Grouper landings are included. The landings for non-Florida Gulf of Mexico were constructed primarily using data housed in the NOAA’s Southeast Fisheries Science Center’s Accumulated Landings System (ALS) from 1986 through 2018. West Florida landings from 1986 through 2018 were obtained from the Florida Trip Ticket program and were preferred over ALS due to the data’s finer temporal resolution. Overall most of the methodologies used to produce landings for the Gulf of Mexico were similar to those used in the last grouper benchmark assessment, SEDAR 42, for Red Grouper. Scamp (and Yellowmouth Grouper) are part of the “Other Shallow Water

Grouper” complex designated by the NMFS Southeast Regional Office, which has been managed under an Individual Fishing Quota (IFQ) program since 2010. Gear grouping for the final landings were provided by year and gear, i.e. Handline, Longline, and Other gears.

Discards were calculated for the directed fishery using discard rates from the Reef Fish Observer Program multiplied by total fishing effort from the Coastal Fisheries Logbook Program. Discard estimation was conducted separately for two gears, vertical line and bottom longline. A verification step compared annual total landed catch from logbook data with the estimated observer annual total landed catch. Once verified, annual total discards in weight and number were estimated for the observer data period 2007-2018, and then hind casted for the period 2000-2006.

Scamp and Yellowmouth Grouper length samples were reviewed for the years 1984-2018 using available TIP length data. Commercial landings length frequency distributions were provided by year and gear (Handline, Longline). Commercial discard lengths from observer data were provided for 2006-2018. Commercial landings ages were weighted by the length frequency distributions and will be provided by year and gear.

3.1.1 Commercial Workgroup Participants

| | | |
|-------------------------|--------------------------|--------------------|
| Beth Wrege | Workgroup Leader | NMFS Miami |
| Julia Defilippi Simpson | Workgroup Leader | ACCSP |
| Mike Rinaldi | Workgroup Rapporteur | ACCSP |
| Alan Bianchi | Workgroup Co-Rapporteur | North Carolina DMF |
| Steve Brown | Data provider | Florida FWC |
| Amy Dukes | Data Provider | South Carolina DNR |
| Julia Byrd | Data Provider | SAFMC |
| Max Lee | Data Provider | Mote Marine Lab |
| Refik Orhun | Data provider | NMFS Miami |
| Kevin McCarthy | Data provider | NMFS Miami |
| Sarina Atkinson | Data provider | NMFS Miami |
| Steven Smith | Data provider | NMFS Miami |
| Molly Stevens | Data provider | NMFS Miami |
| Carole Neidig | Rapporteur/Data provider | Mote Marine Lab |
| Jeff Pulver | Data provider | NMFS SERO |
| Marcel Reichert | ADT | South Carolina DNR |
| Skyler Sagarese | Analyst | NMFS Miami |
| Kyle Shertzer | Analyst | NMFS Beaufort |
| Jay Mullins | Data Provider | Gulf Fisherman |

| | | |
|--------------------|---------------|--------------------------|
| Randy Mckinley | Data Provider | North Carolina Fisherman |
| Jimmy Hull | Data Provider | Hull Seafood |
| Kenneth Roberts | Participant | Louisiana Sea Grant |
| Alexandra Smith | Participant | NMFS Miami |
| Stephanie Martinez | Participant | NMFS Miami |
| Shannon Calay | Participant | NMFS Miami |
| Katie Siegfried | Participant | NMFS Miami |

*Workshop done via webinar format due to COVID-19 Pandemic

3.1.2 Issues Discussed at the Data Workshop

Commercial landings issues the workgroup addressed included historical landings, gears, Florida Trip Ticket data, and IFQ reported landings. The commercial workgroup was briefed on the Stock ID Workshop previous to this SEDAR (SEDAR68) in which the boundary designation was verified and the species composition determined to include both the Scamp and Yellowmouth. Other topics of discussion included unclassified grouper landings, and west Florida data source and proportioning.

3.2 REVIEW OF WORKING PAPERS

The workgroup considered data and analyses presented from the following workshop working papers.

SEDAR68-DW-17: Commercial Discard Length Composition for Gulf of Mexico Scamp and Yellowmouth Grouper. This working paper provided summary data from the NOAA Fisheries Reef Fish Observer Program (RFOP) and Shark Bottom Longline Observer Program (SBLOP). RFOP data were from bottom longline and vertical line gears in the Gulf of Mexico. The SBLOP includes data from only the bottom longline fishery in the eastern Gulf of Mexico. Data from both sources were analyzed by year and gear and length compositions were generated.

SEDAR68-DW-22: The group reviewed the working paper on Mote Marine Lab's Scamp data from their participating electronic monitoring (EM) fisheries. C. Neidig presented on the results of linking EM data with observer, dealer, and TIP (dockside) sampling data. The group agreed that EM data may support mortality, and depth of occurrence, but will primarily inform SEDAR from a qualitative perspective.

3.3 COMMERCIAL LANDINGS

Commercial landings of Scamp and Yellowmouth Grouper in the Gulf of Mexico were compiled from 1962 - 2018, from now on referred to as “Landings”. Gulf States landings from Texas to Alabama were obtained from the SEFSC’s Accumulated Landings System (ALS) maintained in the SEFSC's Oracle database. The west Florida landings 1986 – 2018 collected by the Florida Trip Ticket Program were obtained from the ACCSP database.

The total combined landings for the Gulf of Mexico are shown in Table 3.1 and Figure 3.4 by year and gear (Handline, Longline, and Other). There are several situations where the commercial landings data, as they change temporally (annual to month to trip-level/daily), may not have the desired level of resolution. Thus, the recommendation was made to limit the commercial landings data to begin in 1986. This was not accepted. The following issues were identified:

Florida Trip Ticket Program

Comparisons were made between the commercial Florida Trip Ticket Program and NMFS SEFSC CFLP (Coastal Fisheries Logbook Program) logbook data. Both datasets were very similar in landings trends and level of landings reported for matching years. While no direct comparison was made between Florida Trip Ticket Program (FTT) and ALS General Canvass, it was decided to use the total landings from the Florida Trip Ticket data over the General Canvass and CFLP logbook since General Canvass data are Florida Trip Ticket data since 1997, the Florida Trip Ticket data are more complete and are of a longer time series than the CFLP logbook data.

One issue arose with regard to Scamp landings from Florida Gulf of Mexico waters: how to apportion Scamp from unclassified grouper. Since Scamp have been coded to species since 1986, it was decided to apportion Scamp from unclassified grouper on trips where only unclassified grouper was reported. The rationale was that if grouper were coded to species on trips that also included unclassified grouper, the dealer was probably diligent in reporting major grouper species correctly. To apportion Scamp from unclassified only grouper, Florida Trip Ticket data were used to calculate the ratio of Scamp to total identified grouper which was then applied to unclassified only grouper landings by year and gear from 1962-1985.

The quantity of Gulf Scamp from the Florida Trip Ticket Program (FTT) data was determined by calculating the annual Gulf Scamp stratified by area and gear from the CFLP logbook data. The decision to use CFLP logbook data for proportioning gear and area was based on the general acceptance that effort and location data are more accurate on fisher reported logbook records than on dealer reported trip tickets. Proportions were calculated by dividing the amount of Gulf Scamp by area and gear into total Scamp for each year from 1992-2018. Since reliable CFLP logbook data were not available prior to 1993, gear and area data were retained for Florida from the ALS General Canvass but were scaled to the Florida Trip Ticket total.

The average proportion of landings was applied to the corresponding Monroe Scamp and Yellowmouth landings from 1986 – 1992. Gulf of Mexico (non-Monroe) and calculated Gulf of Mexico Monroe County landings were then combined into a total representing Scamp and Yellowmouth landings for the west coast of Florida. This assures there were no duplication. This was done by dividing landings for each gear into total Florida Gulf of Mexico landings, then applying those proportions to the Florida Trip Ticket Gulf of Mexico landings by year from 1993 to 2013.

The average proportion of CFLP logbook landings from 1993 through 2009, by gear, was then applied to trip ticket landings from 1986 to 1992. Data later than 2009 were not used in calculating a mean due to the beginning of IFQ fisheries and a temporary hook limitation on long line gears in 2010, as well as seasonal closures on bottom long line. Data from 2010-2013 were not used in calculating a mean as there were closed seasons.

Texas to Alabama Landings

For ALS landings data in Texas, Mississippi, and Alabama, CFLP logbook data has been used to assign gear and area information for 1993 forward. The same treatment (assignment of gear and area) was applied to the Louisiana landings, but for 1990-1999. The Texas trip ticket program began in 2000. Further details regarding the data in ALS and General Canvass can be found in Appendix A.

1. For Louisiana, gear and fishing area are not available for 1990 - 1999
2. For Texas, gear and fishing area are not available for 1990 - 2011.

Decision 1: It was the workgroup’s recommendation to use Florida trip ticket data when available (1986-2018).

This decision was approved by the plenary.

Decision 2: It was the workgroup’s recommendation to use logbook data to apportion annual state landings to gear and area.

This decision was approved by the plenary.

3.3.1 Commercial Gears

Work group discussion on fleet composition and predominant gears resulted in the final three gear groupings of Handline, longline, and other Handline including hook and line, electric/hydraulic (a.k.a., bandit) reels, and trolling. The list of gears used in the assessment can be found in Table 3.2a for Non-FL States and Table 3.2b for West Florida, respectively. The non-FL states (TX-AL) used ALS data with NMFS gear codes; whereas West Florida used the Florida Trip Ticket data with FIN gear codes.

Based on previous benchmark information from SEDAR 22 Yellowedge Grouper, it was discussed that longline fisheries for grouper species did not begin until 1979 in the Gulf of Mexico.

Decision 3: The workgroup suggested three gear groupings to characterize the Scamp fishery (Handline, longline, and other). Handline include hook and line, electric/hydraulic bandit reels, and trolling.

This decision was approved by the plenary.

Decision 4: It was decided by the commercial working group that there was no longline fishery prior to 1979. There were only two fisheries from 1962 – 1979, Handline and other. After 1979, there were three gear groupings, Handline, longline, and other.

This decision was approved.

3.3.2 Boundaries

DW ToR #1: Review stock structure and unit stock definitions and consider whether changes are required. There was a species identification workshop where the stock boundary was covered. Figure 3.1 shows the US Fisheries Management Regions of the Atlantic seaboard and the Gulf of Mexico. Gulf of Mexico landings are spatially distributed using the statistical areas 1 to 21, reaching from statistical area 1 in the Florida Keys to statistical area 21 bordering Mexico, see Figure 3.2. The CFLP landings are reported by statistical area 1-21. ALS landings are reported by waterbody. When available, water body code is converted to statistical areas using the first two digits of the water body codes. When ALS water body is not available, the county of landing was used.

The Gulf of Mexico and South Atlantic stock boundary lays in CFLP Statistical areas 1 and 2. The Gulf of Mexico landings from areas 1 and 2 are taken from water bodies north of highway U.S. 1 in the Florida Keys and north of the boundary line that extends from Key West to the Dry Tortugas. Waters west of the Dry Tortugas are considered to be the Gulf of Mexico (Figure 3.3).

Decision 5: The workgroup's recommendation was to maintain the region boundaries as defined by the Gulf of Mexico Council boundaries between CFLP statistical grid areas 1 and 21.

This decision was approved by the plenary.

3.3.3 Scamp/Yellowmouth Groupers Misidentification

Both Scamp and Yellowmouth Grouper are very similar in their external appearances, and the adults of both species reach approximately the same maximum size. Because of the two species' similarity, they report that Yellowmouth Grouper and Scamp are both marketed as Scamp, though Yellowmouth's contribution to 'Scamp' landings are low but exact proportions are unknown. Therefore, Scamp and Yellowmouth Grouper landings will be combined for all sources of data (landings, indices, length comps, age comps, discards) for the assessment.

Decision 6: The workgroup's recommendation is to combine Yellowmouth Grouper with the Scamp landings, since they cannot be differentiated from Scamp, and as recommended in the Scamp/Yellowmouth Stock-Id workshop.

This decision was approved by the plenary.

3.3.4 Unclassified Groupers

Prior to 1986 all grouper landings, with the exception of Goliath and Warsaw, were reported as unclassified grouper. After this time unclassified grouper can still be found to varying degrees but are very minor since 2000. After groupers began to be classified in 1986 a mean Scamp proportion was created using data for 1986-1989, and applied back in time to unclassified grouper landings beginning in 1962.

Since Scamp have been identified to species since 1986, it was decided to apportion Scamp from unclassified grouper on trips where only unclassified grouper was reported. The rationale was that if grouper were coded to species on trips that also included unclassified grouper, the dealer was probably diligent in reporting major grouper species correctly.

To apportion Scamp from unclassified only grouper, landings were used to calculate the ratio of Scamp to total identified grouper. The proportion of Scamp to the total identified grouper $\{(Scamp) / (all\ identified\ grouper\ species)\}$ was developed for each year and state. It was then applied to unclassified only grouper landings by year and gear from 1962-2018.

For West Florida

Landings from the ACCSP database were selected for 1962-1985. Data were originally sourced from the NMFS General Canvass survey. All base data reported unclassified groupers. Data were separated between the South Atlantic and Gulf of Mexico using the subregion code, county landed, and/or the reported fishing area. Proportions of Gulf of Mexico Scamp and Yellowmouth Grouper to unclassified grouper were calculated for 1986-1991. Gulf of Mexico gear proportions were also created for the same years. Species proportions were applied to unclassified grouper landings by year. Gear proportions were applied as well, with the following caveat.

Decision 7: The workgroup recommended using a mean Scamp proportion from 1986 through 1989 for grouper landings prior to 1986 for Non-FL Gulf of Mexico states to remain consistent with SEDARs 42 and 12 for Red Grouper. For the Gulf of Mexico, the unclassified groupers were only available 1962 and after. All of Florida was processed with the rest of the South Atlantic states by ACCSP. Calculated Scamp proportions were applied to *West* Florida landings of unclassified groupers starting in 1962.

This decision was approved by the plenary.

3.3.5 IFQ Landings

The Scamp Individual Fishing Quota program (IFQ) is an [online system](#) where all transactions (share, allocation, and landing transfers) are recorded immediately upon entry by Scamp and Yellowmouth Grouper-IFQ participants. Landing transactions contain the following information: shareholder, vessel, and dealer name, landing date/time, landing location, species and pounds landed, and a landing confirmation number. Landings transactions cannot be completed for more pounds than are allocated to the vessel at the time of the landing and are not completed until approved by both the dealer and shareholder. Scamp is part of the Other Shallow-Water Grouper (OTHER SWG) IFQ program which records weights in gutted-pounds. Individual landings were summed for ‘annual total pounds landed’. Additional information concerning the IFQ program can be found in Appendix B. Landings from IFQ and ALS/TTP were compiled and adjusted for 2010 through 2018 (Table 3.3).

Decision 8: Use IFQ landings to adjust compiled landings from 2010 through 2018. Apply the differences between the compiled and IFQ landings across all strata.

3.4 COMMERCIAL DISCARDS

The general approach for estimating discards for the commercial reef fish fleet in the Gulf of Mexico utilizes catch-per-unit-effort (CPUE) from the coastal reef fish observer program and total fishing effort from the commercial reef logbook program to estimate total catch.

For discard estimation, CPUE was computed for total discards, including fish released alive, released dead, released in unknown condition, and used for bait. Discard estimation for Gulf of Mexico Scamp/Yellowmouth Grouper was conducted separately for two gears, vertical line and bottom longline. A verification step compared annual total landed catch from logbook data with the estimated observer annual total landed catch. Once verified, Scamp/Yellowmouth Grouper annual total discards in weight and number were estimated for the observer data period 2006-2017, and then hind casted for the period 2000-2006. Full details of the methodology applied to Gulf of Mexico Scamp/Yellowmouth Grouper are described in the working paper SEDAR68-DW-30 (Smith et al. 2020).

CPUE expansion estimates for annual discards in numbers and weight of GOM Scamp/Yellowmouth Grouper for 2000-2018 are provided in Table 3.4.1 for vertical line gear. Estimated discards in number ranged from 3,000 to 4,000 fish during the pre-IFQ management regime 2000-2009, and averaged about 2,500 fish during the IFQ management regime 2010-2018 (Fig. 3.4.1 A). Discards in weight accounted for about 3% of the total catch (kept + discards) during 2000-2009 and 3.5 to 5% of the total catch during 2010-2018 (Fig. 3.4.1 B).

CPUE expansion estimates for annual discards in numbers and weight of GOM Scamp/Yellowmouth Grouper for 2000-2018 are provided in Table 3.4.2 for bottom longline gear.

Estimated discards in number averaged about 500 fish for 2000-2018 (Fig. 3.4.2 A). Discards in weight accounted for about one to 1.5% of the total catch (kept + discards) during 2000-2018 (Fig. 3.4.2 B).

Working Paper reference:

Smith, S.G., S. Martinez, K.J. McCarthy. 2020. CPUE Expansion Estimation for Commercial Discards of Gulf of Mexico Scamp and Yellowmouth Grouper. SEDAR68-DW-30. SEDAR, North Charleston, SC. 27 pp.

3.5 COMMERCIAL EFFORT

Spatial distribution of commercial effort is aggregated from the Coastal Fisheries Logbook Program (CFLP) and presented in the NMFS Area Code grid also called the NMFS Statistical Area grid (Figure 3.5.1). Total Cumulative Scamp Effort (in Trips) 1990 - 2019 for both the Gulf of Mexico and South Atlantic (start 1992) is shown in Figure 3.5.2. Mean Annual Effort (in Trips) for 1990 - 2019 for both the Gulf of Mexico and South Atlantic (starts in 1992) is shown in Figure 3.5.3. Total Cumulative Effort and Mean Annual Effort (in Trips) for the Gulf Mexico are shown in Figure 3.5.4 and Figure 3.5.5, respectively. The distribution of directed commercial effort in trips by year for the Gulf of Mexico 1990 -2019 is shown in Figure 3.5.6.

3.6 BIOLOGICAL SAMPLING

Biological sample data for Scamp and Yellowmouth Grouper were obtained from the TIP database housed at NMFS-SEFSC (1984-2018) and the Gulf States Marine Fisheries

Commission's Fisheries Information Network (GulfFIN, 2002-2018). Data were filtered to eliminate records that included a size or effort bias and non-random collection of length data.

3.6.1 Sampling Intensity

The bulk of the samples came from Florida, where there was a high of 3,300 fish sampled for LONGLINE gear and 2,168 for HANDLINE gear, both occurring in 1999. The average number of fish caught via HANDLINE per year for FL, AL, MS, LA, and TX were 909, 84, 30, 309, and 60, respectively. The average number of fish caught via LONGLINE per year for FL, AL, LA, and TX were 1214, 11, 24, and 40, respectively, with no samples for this gear from MS.

Following the Data Workshop, weighted compositions were developed, and minimum sample size cutoffs were explored for both number of fish and number of trips. Details pertaining to these sample sizes can be found in the working paper that will be available following the release of the Data Workshop report and prior to the Assessment Workshop.

3.6.2 Length/Age distributions

Scamp and Yellowmouth Grouper length samples were reviewed for the years 1984-2018 using available TIP length data. Commercial landings length frequency distributions will be provided by year and gear (Handline and Longline). Commercial discard lengths from observer data were provided for 2006-2018. Commercial landings ages were weighted by the length distribution frequency distributions and will be provided by year and gear. Details of these compositions will be provided in a working paper following the Data Workshop.

3.6.3 Adequacy for Characterizing Catch

Adequacy of length data and length sampling fractions will be reported in the Assessment Workshop Report.

3.7 ADEQUACY OF DATA FOR ASSESSMENT ANALYSES

Overall the workgroup felt the landings were adequate for assessment analyses. Landings after 1986 should be considered most accurate as this is when trip tickets went into place and landings were generally reported to species (e.g. reported as red grouper instead of 'unclassified' grouper). IFQ landings used for 2010 through 2018 were also agreed upon as being the most accurate.

The workgroup felt the commercial landings length samples appear to be adequate for assessment analyses. There appears to be an adequate number of samples for most years for predominant gears, especially Handline and Longline. There were fewer age samples, but the workgroup felt those data were the best available science and should be weighted by length frequency distributions.

3.8 RESEARCH RECOMMENDATIONS

- **Recommendation for assigning annual uncertainty estimates.**
 - Assign annual uncertainty estimates (e.g., SE) to historic and recent commercial landings by fishery, which would allow the assessment to include all available landings data while accounting for greater uncertainty in the historic period.
- **Recommendation for sustained investment in EM infrastructure for the GoM.**
 - Support a sustained investment in Electronic Monitoring (EM) infrastructure for the GoM commercial reef fish fishery. The strides taken by the Center for Electronic Monitoring at Mote (CFEMM) in applying EM in the commercial reef fish fishery has resulted in permanent imagery and sensor documentation of over 300 BLL and VL reef fish trips, >100,000 detailed catch records, from over 2,300 sea days and counting. Continuing this valuable monitoring effort will provide additional CPUE metrics for consideration in stock assessments. This monitoring tool is for researchers to directly observe and permanently document location, identify bycatch hotspots, catch, effort, and discard data, which may help to reduce uncertainty in stock assessments.
 - EM has proven to be effective for permanently documenting the time and location of bycatch events to quantify bycatch rates and identify bycatch hotspots, and importantly, discard condition data which may reduce uncertainty in discard mortality estimation, especially regarding bottom longline trips.
- **Support the application of EM with biological sample collection for priority species.**
 - The COVID-19 pandemic has hampered interactions between the fishing industry and state/federal fisheries data collections. The working group recognizes the potential for work pioneered by the CFEMM to advance biological sampling needs without human observers while providing accurate georeferenced capture data.

- **Provide regional support for machine learning (ML) activities.**
 - Develop EM ML efforts and leverage over 200 terabytes of species video imagery footage and CFEMM data to improve regional capabilities to advance artificial intelligence (AI), and support the development of image recognition to automatically identify species presence, species of fish, and their weight estimates.

3.9 TABLES

Table 3.1 Annual Scamp and Yellowmouth Grouper Landings in gutted pounds for 1962 -2018.

| YEAR | HANDLINE | LOGLINE | OTHER |
|-------------|-----------------|----------------|--------------|
| 1962 | 188,783 | - | 3,546 |
| 1963 | 171,674 | - | 3,016 |
| 1964 | 176,900 | - | 3,430 |
| 1965 | 189,173 | - | 3,630 |
| 1966 | 166,558 | - | 3,297 |
| 1967 | 149,936 | - | 3,368 |
| 1968 | 157,703 | - | 3,608 |
| 1969 | 166,414 | - | 3,621 |
| 1970 | 170,984 | - | 3,912 |
| 1971 | 163,337 | - | 3,854 |
| 1972 | 163,993 | - | 5,185 |
| 1973 | 132,827 | - | 4,139 |
| 1974 | 148,264 | - | 3,453 |
| 1975 | 166,498 | - | 3,480 |
| 1976 | 155,337 | - | 4,238 |
| 1977 | 121,154 | - | 2,555 |
| 1978 | 113,050 | - | 4,792 |
| 1979 | 148,139 | - | 3,576 |
| 1980 | 155,965 | - | 4,160 |
| 1981 | 112,248 | 107,395 | 21,394 |
| 1982 | 140,378 | 138,315 | 13,675 |
| 1983 | 110,837 | 103,459 | 17,626 |
| 1984 | 121,491 | 117,803 | 4,242 |
| 1985 | 126,997 | 144,820 | 4,416 |
| 1986 | 178,419 | 174,428 | 5,427 |
| 1987 | 180,055 | 154,071 | 5,340 |
| 1988 | 155,529 | 110,414 | 3,919 |
| 1989 | 160,144 | 127,059 | 4,220 |
| 1990 | 98,192 | 109,171 | 57,821 |
| 1991 | 126,139 | 129,427 | 59,509 |

| | | | |
|------|---------|---------|--------|
| 1992 | 166,389 | 76,227 | 59,245 |
| 1993 | 157,538 | 102,138 | 60,858 |
| 1994 | 107,612 | 57,454 | 50,830 |
| 1995 | 130,757 | 60,779 | 44,332 |
| 1996 | 127,484 | 66,711 | 38,874 |
| 1997 | 136,524 | 79,514 | 76,299 |
| 1998 | 98,858 | 85,243 | 36,720 |
| 1999 | 103,403 | 85,405 | 71,820 |
| 2000 | 114,610 | 73,528 | 11,721 |
| 2001 | 133,561 | 112,002 | 22,235 |
| 2002 | 149,583 | 118,036 | 37,010 |
| 2003 | 164,034 | 136,708 | 11,874 |
| 2004 | 151,845 | 151,716 | 15,581 |
| 2005 | 154,666 | 141,964 | 12,184 |
| 2006 | 115,796 | 86,283 | 16,040 |
| 2007 | 134,089 | 120,265 | 20,565 |
| 2008 | 122,179 | 138,725 | 17,138 |
| 2009 | 141,611 | 89,656 | 19,705 |
| 2010 | 75,921 | 64,936 | 15,197 |
| 2011 | 75,374 | 60,415 | 10,095 |
| 2012 | 141,093 | 93,246 | 16,090 |
| 2013 | 125,540 | 103,610 | 16,077 |
| 2014 | 96,973 | 62,095 | 9,394 |
| 2015 | 91,383 | 80,820 | 6,310 |
| 2016 | 141,099 | 143,307 | 1,629 |
| 2017 | 84,706 | 77,086 | 1,185 |
| 2018 | 71,279 | 68,711 | 2,616 |

Table 3.2 A SEFSC ALS Non-FL States Gear Groups with NMFS Gear Codes

| HANDLINE | |
|-----------------------|---|
| NMFS GEAR CODE | GEAR DESCRIPTION |
| 600 | COMBINED GEARS |
| 610 | COMBINED GEARS, LINES HAND, OTHER |
| 611 | COMBINED GEARS, ROD AND REEL |
| 612 | REEL, MANUAL |
| 613 | REEL, ELECTRIC OR HYDRAULIC, COMBINED GEARS |
| 616 | COMBINED GEAR |
| 657 | LINES TROLL, GREEN-STICK |
| 660 | LINES TROLL, OTHER |
| 661 | LINES POWER TROLL, OTHER |
| LONGLINE | |
| NMFS GEAR CODE | GEAR DESCRIPTION |
| 614 | BUOY GEAR, VERTICAL |
| 675 | COMBINED GEARS, LINES LONG WITH HOOKS |
| 674 | COMBINED GEARS, LINES LONG, REEF FISH |
| 677 | COMBINED GEARS, LINES LONG, SHARK |
| OTHER | |
| NMFS GEAR CODE | GEAR DESCRIPTION |
| * | ALL OTHER GEARS |

Table 3.2 B ACCSP West Florida Trip Ticket Program Gear Groups with Fin Gear Codes.

| HANDLINE | | | |
|------------------------------|-----------------------------|------------------|----------------------|
| GEAR CODE | GEAR NAME | TYPE CODE | GEAR TYPE |
| 300 | HOOK AND LINE | 7 | HOOK AND LINE |
| 301 | HOOK AND LINE, MANUAL | 7 | HOOK AND LINE |
| 302 | HOOK AND LINE, ELECTRIC | 7 | HOOK AND LINE |
| 303 | ELECTRIC/HYDRAULIC, BANDIT | 7 | HOOK AND LINE |
| 304 | HOOK AND LINE, CHUM | 7 | HOOK AND LINE |
| 305 | HOOK AND LINE, JIG | 7 | HOOK AND LINE |
| 306 | HOOK AND LINE, TROLL | 7 | HOOK AND LINE |
| 307 | HOOK AND LINE, CAST | 7 | HOOK AND LINE |
| 308 | HOOK AND LINE, DRIFTING EEL | 7 | HOOK AND LINE |
| 309 | HOOK AND LINE, FLY | 7 | HOOK AND LINE |
| 310 | HOOK AND LINE, BOTTOM | 7 | HOOK AND LINE |
| 320 | TROLL LINES | 7 | HOOK AND LINE |
| 321 | TROLL LINE, MANUAL | 7 | HOOK AND LINE |
| 322 | TROLL LINE, ELECTRIC | 7 | HOOK AND LINE |
| 323 | TROLL LINE, HYDRAULIC | 7 | HOOK AND LINE |
| 324 | TROLL LINE, GREEN-STICK | 7 | HOOK AND LINE |
| 330 | HAND LINE | 13 | HAND LINE |
| 331 | TROLL & HAND LINE CMB | 13 | HAND LINE |
| 340 | AUTO JIG | 13 | HAND LINE |
| 700 | HAND LINE | 13 | HAND LINE |
| 701 | TROLL AND HAND LINES CMB | 13 | HAND LINE |
| 702 | HAND LINES, AUTO JIG | 13 | HAND LINE |
| LOGLINE (1981-onward) | | | |
| GEAR CODE | GEAR NAME | TYPE CODE | GEAR TYPE |
| 400 | LONG LINES | 8 | LONG LINES |
| 401 | LONG LINES, VERTICAL | 8 | LONG LINES |
| 402 | LONG LINES, SURFACE | 8 | LONG LINES |
| 403 | LONG LINES, BOTTOM | 8 | LONG LINES |
| 404 | LONG LINES, SURFACE, MIDWA | 8 | LONG LINES |
| 405 | LONG LINES, TROT | 8 | LONG LINES |
| 406 | LONG LINES, TURTLE HOOKS | 8 | LONG LINES |
| 407 | LONG LINES, DRIFT W/HOOKS | 8 | LONG LINES |
| 408 | BOUY GEAR | 8 | LONG LINES |
| OTHER | | | |
| GEAR CODE | GEAR NAME | TYPE CODE | GEAR TYPE |
| * | All other gears | * | All other gear types |

Table 3.3 Annual IFQ correction factors from ALS to IFQ.

| Year | IFQ Correction Factors |
|------|------------------------|
| 2010 | 0.984611 |
| 2011 | 1.025188 |
| 2012 | 0.996947 |
| 2013 | 0.989045 |
| 2014 | 0.996538 |
| 2015 | 1.020419 |
| 2016 | 0.996953 |
| 2017 | 0.996735 |
| 2018 | 1.001332 |

Table 3.4.1 Time-series of CPUE expansion estimates for GOM Scamp & Yellowmouth Grouper vertical line discards in weight (lbs.) and number (with associated standard errors).

| Year | Estimated Discards in Weight | SE of | | SE of Estimated Discards in Number |
|------|------------------------------|------------------------------|------------------------------|------------------------------------|
| | | Estimated Discards in Weight | Estimated Discards in Number | |
| 2000 | 4,035.2 | 1,556.7 | 2,946.0 | 1,149.4 |
| 2001 | 4,727.3 | 1,823.7 | 3,469.9 | 1,353.9 |
| 2002 | 5,239.0 | 2,021.1 | 3,842.2 | 1,499.1 |
| 2003 | 5,790.0 | 2,233.7 | 4,235.7 | 1,652.6 |
| 2004 | 5,582.6 | 2,153.7 | 4,083.2 | 1,593.1 |
| 2005 | 4,913.5 | 1,895.5 | 3,611.2 | 1,409.0 |
| 2006 | 4,416.5 | 1,703.8 | 3,230.8 | 1,260.6 |
| 2007 | 4,186.5 | 1,615.0 | 3,080.2 | 1,201.8 |
| 2008 | 3,746.5 | 1,490.8 | 2,747.8 | 1,113.3 |
| 2009 | 4,562.8 | 1,833.7 | 3,356.1 | 1,382.2 |
| 2010 | 3,910.7 | 2,175.9 | 2,421.5 | 1,019.3 |
| 2011 | 4,418.2 | 2,458.3 | 2,735.7 | 1,151.5 |

| | | | | |
|------|---------|---------|---------|---------|
| 2012 | 5,528.0 | 3,075.8 | 3,422.9 | 1,440.8 |
| 2013 | 4,557.2 | 2,535.6 | 2,821.7 | 1,187.8 |
| 2014 | 4,291.1 | 2,387.6 | 2,657.0 | 1,118.4 |
| 2015 | 3,717.3 | 2,068.3 | 2,301.7 | 968.9 |
| 2016 | 4,506.3 | 2,507.3 | 2,790.3 | 1,174.5 |
| 2017 | 3,411.2 | 1,898.0 | 2,112.2 | 889.1 |
| 2018 | 2,944.6 | 1,638.4 | 1,823.3 | 767.5 |

Table 3.4.2 Time-series of CPUE expansion estimates for GOM Scamp & Yellowmouth Grouper bottom longline discards in weight (lbs.) and number (with associated standard errors).

| Year | Estimated Discards in Weight | SE of Estimated Discards in Weight | Estimated Discards in Number | SE of Estimated Discards in Number |
|------|------------------------------|------------------------------------|------------------------------|------------------------------------|
| 2000 | 1,237.0 | 773.0 | 461.9 | 229.5 |
| 2001 | 1,547.5 | 967.1 | 564.2 | 280.3 |
| 2002 | 1,453.6 | 908.4 | 532.8 | 264.7 |
| 2003 | 1,728.2 | 1,080.0 | 643.1 | 319.5 |
| 2004 | 1,900.6 | 1,187.7 | 688.0 | 341.8 |
| 2005 | 1,925.4 | 1,203.2 | 691.9 | 343.8 |
| 2006 | 1,354.6 | 846.5 | 510.0 | 253.4 |
| 2007 | 1,518.0 | 948.6 | 536.8 | 266.7 |
| 2008 | 1,895.6 | 1,184.6 | 667.3 | 331.6 |
| 2009 | 1,232.5 | 770.2 | 429.8 | 213.6 |
| 2010 | 460.8 | 180.8 | 250.5 | 83.3 |
| 2011 | 742.1 | 291.2 | 403.4 | 134.2 |
| 2012 | 697.6 | 273.7 | 379.2 | 126.1 |
| 2013 | 842.0 | 330.4 | 457.7 | 152.2 |
| 2014 | 963.7 | 378.1 | 523.9 | 174.3 |
| 2015 | 1,136.9 | 446.1 | 618.1 | 205.6 |
| 2016 | 1,220.9 | 479.0 | 663.7 | 220.8 |
| 2017 | 1,184.1 | 464.6 | 643.7 | 214.1 |
| 2018 | 1,039.3 | 407.8 | 565.0 | 187.9 |

3.10 FIGURES

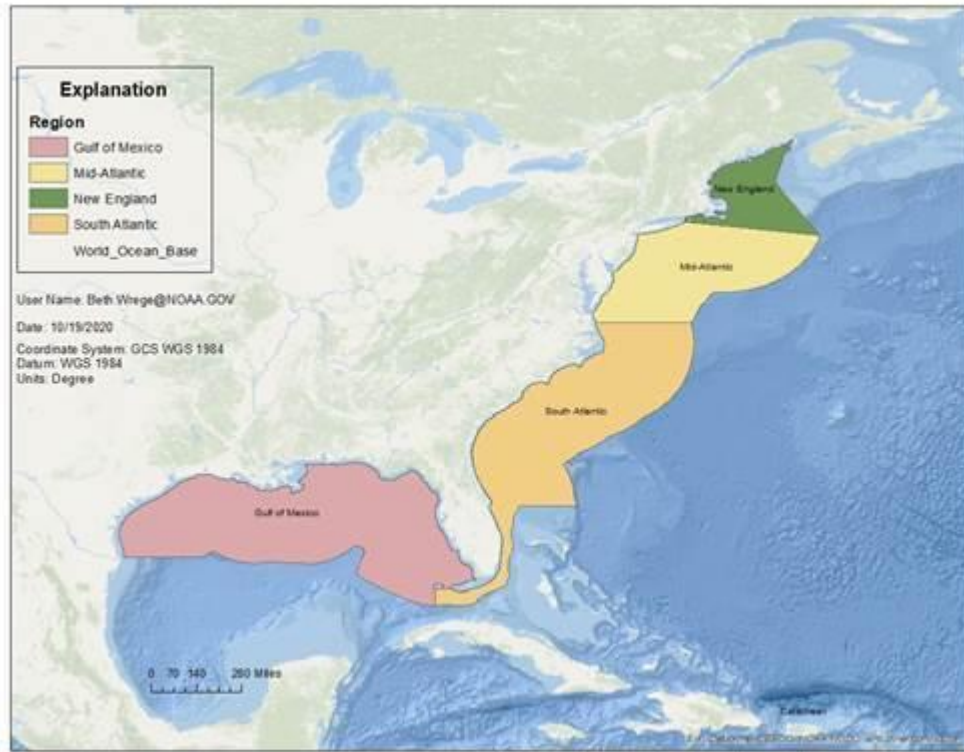

Figure 3.1 Map showing Fisheries Management Region in the Atlantic Ocean.

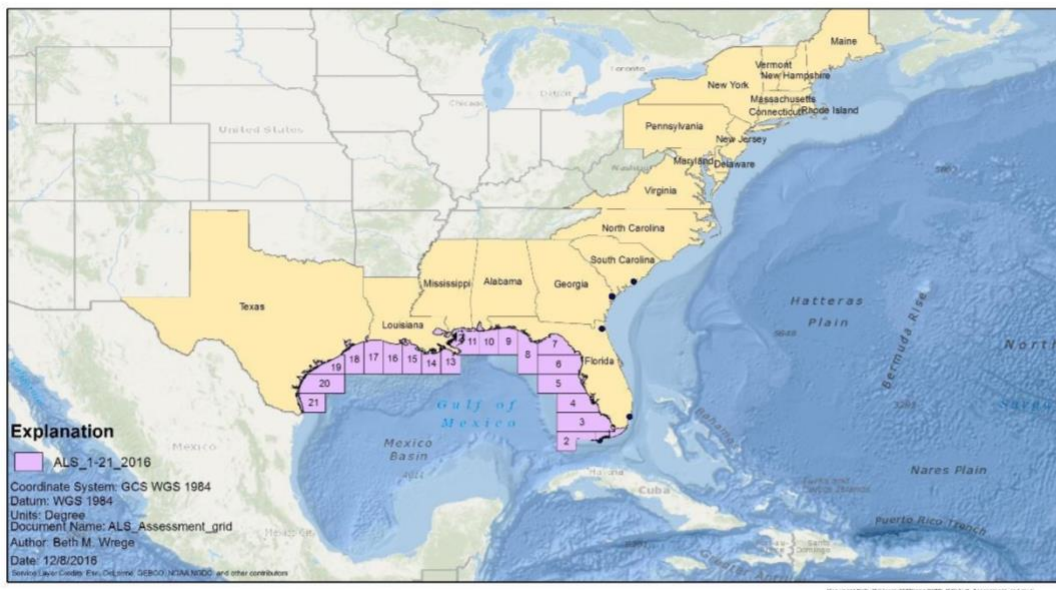

Figure 3.2 Map showing the NMFS Area code/Statistical areas 1-21 from Key West at the Southern tip of Florida to the Texas/Mexico border

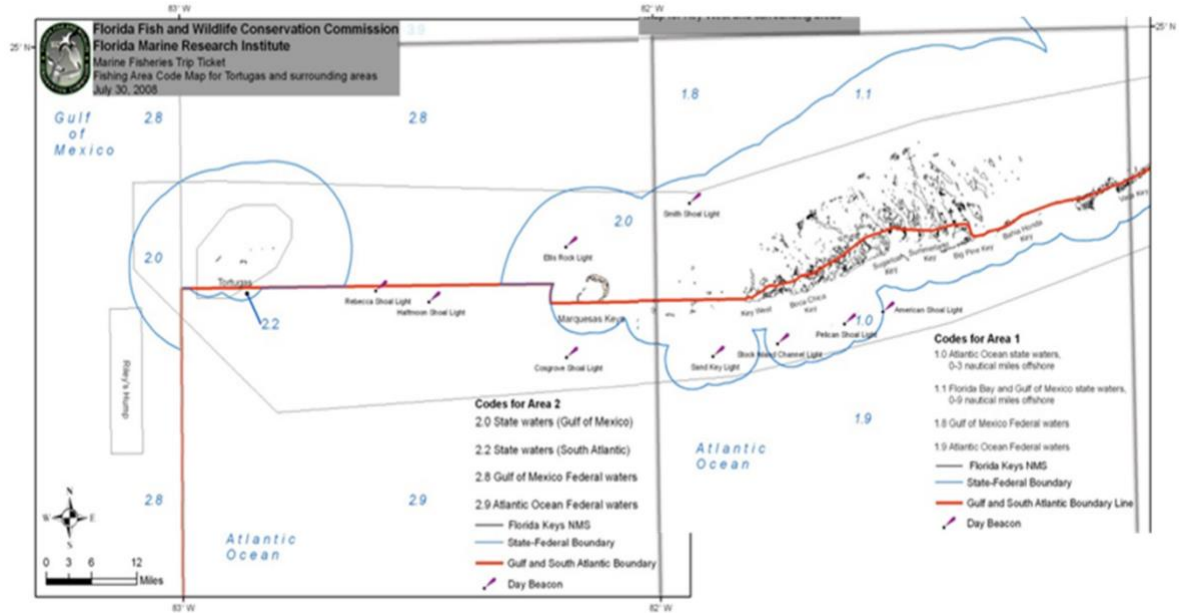

Figure 3.3 Close-up of the southern boundary as defined by the Gulf of Mexico/South Atlantic Council boundary.

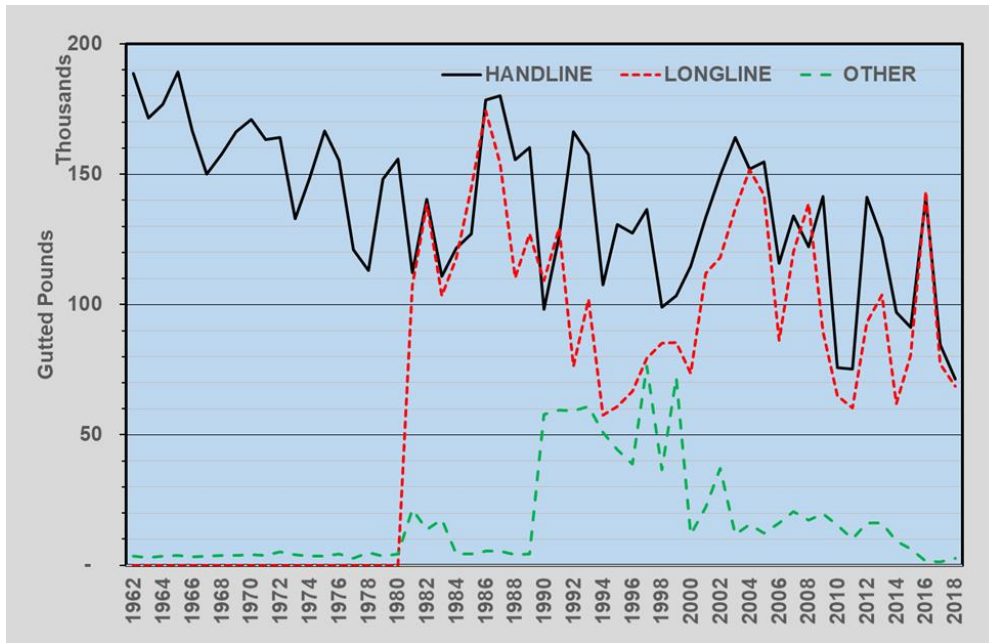

Figure 3.3a Scamp (and YM) Gulf of Mexico landings 1962-2018, in gutted-weight pounds by gear groups.

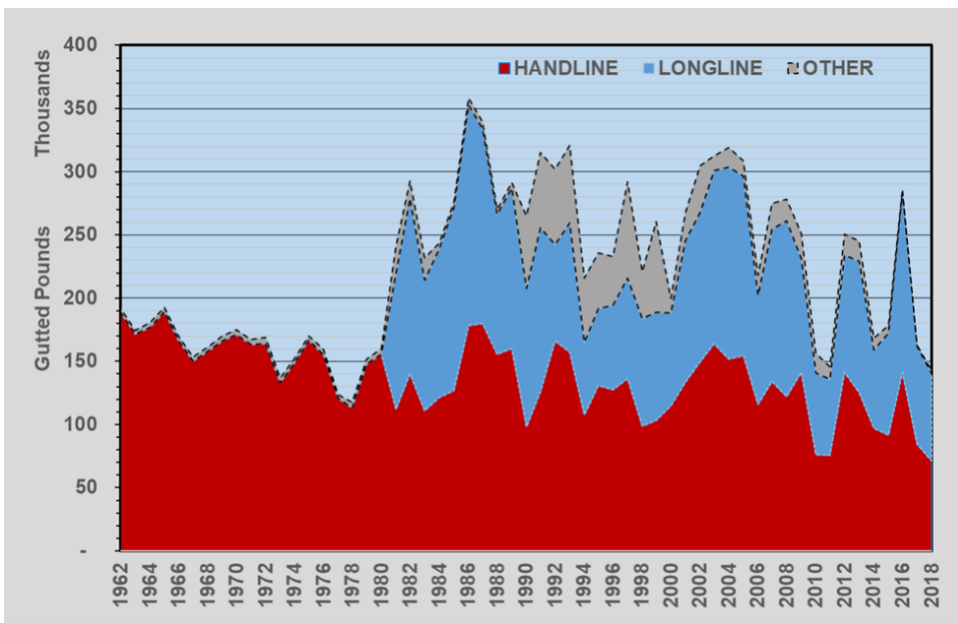
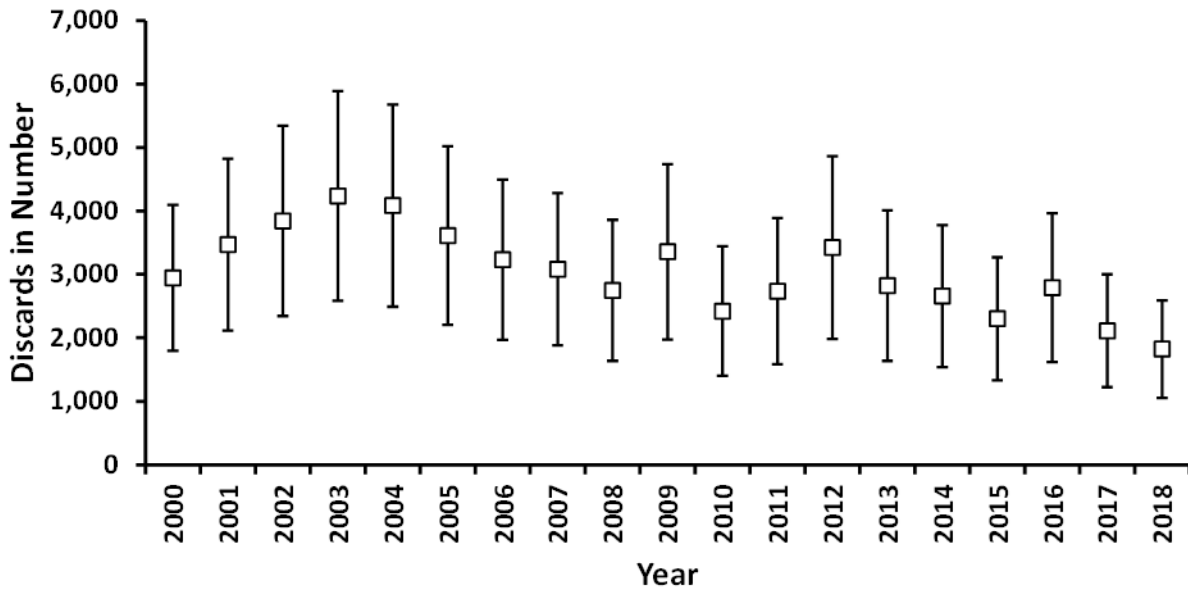

Figure 3.3b Stacked Scamp (and YM) Gulf of Mexico landings 1962-2018, in gutted-weight pounds by gear groups.

(A) Discards in Number



(B) Discards in Weight, Percentage of Total Catch

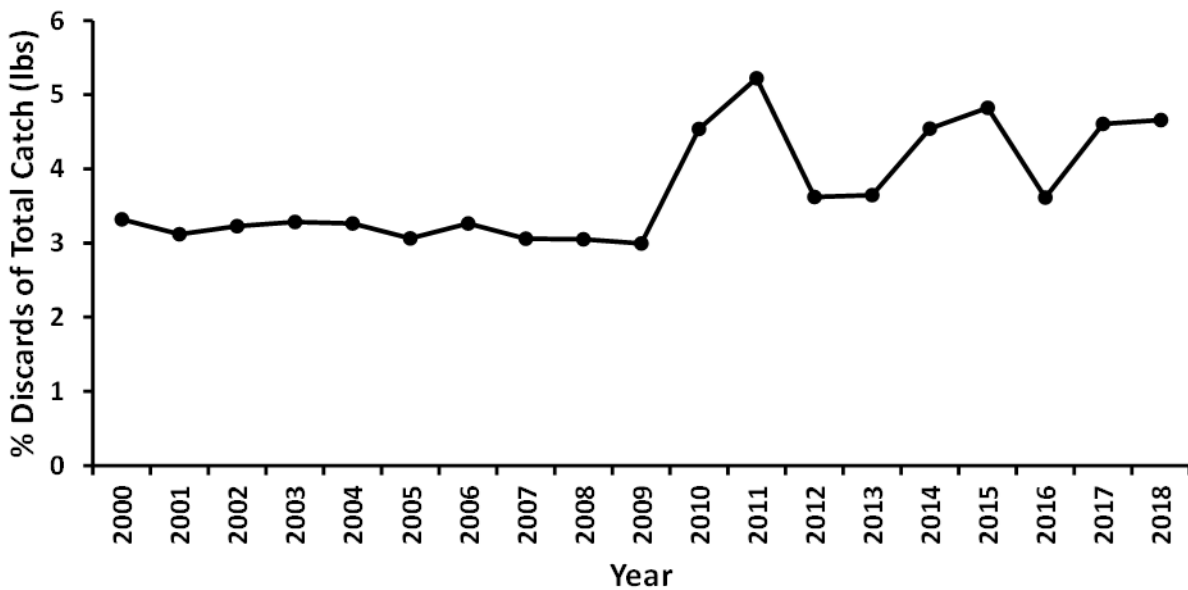
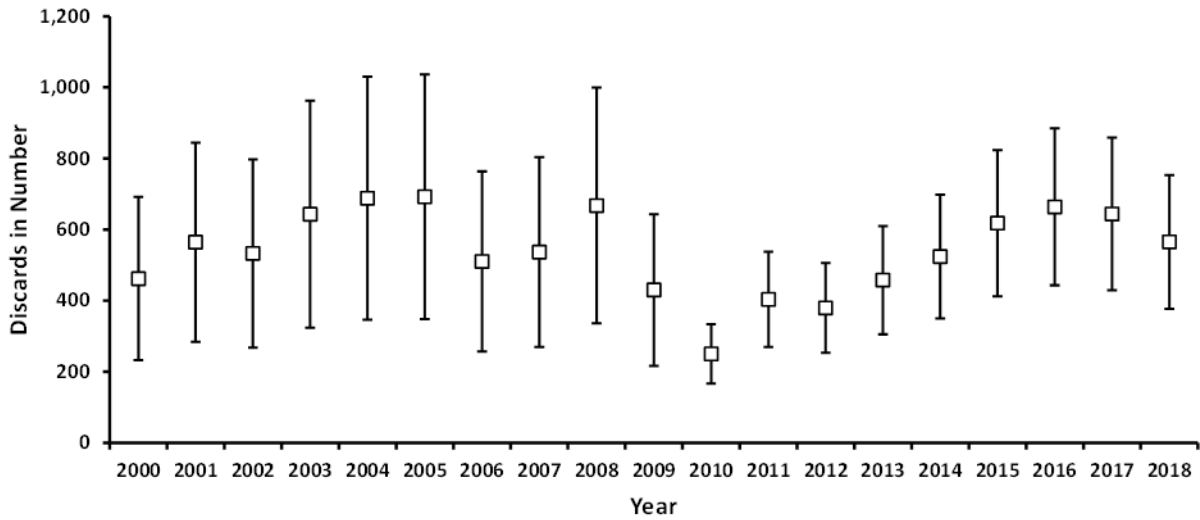

Figure 3.4.1 Observer CPUE expansion estimates of GOM Scamp/Yellowmouth Grouper vertical line annual discards (\pm SE) in (A) number and (B) weight expressed as percentage of total catch (kept + discards) for 2000-2018.

(A) Discards in Number



(B) Discards in Weight, Percentage of Total Catch

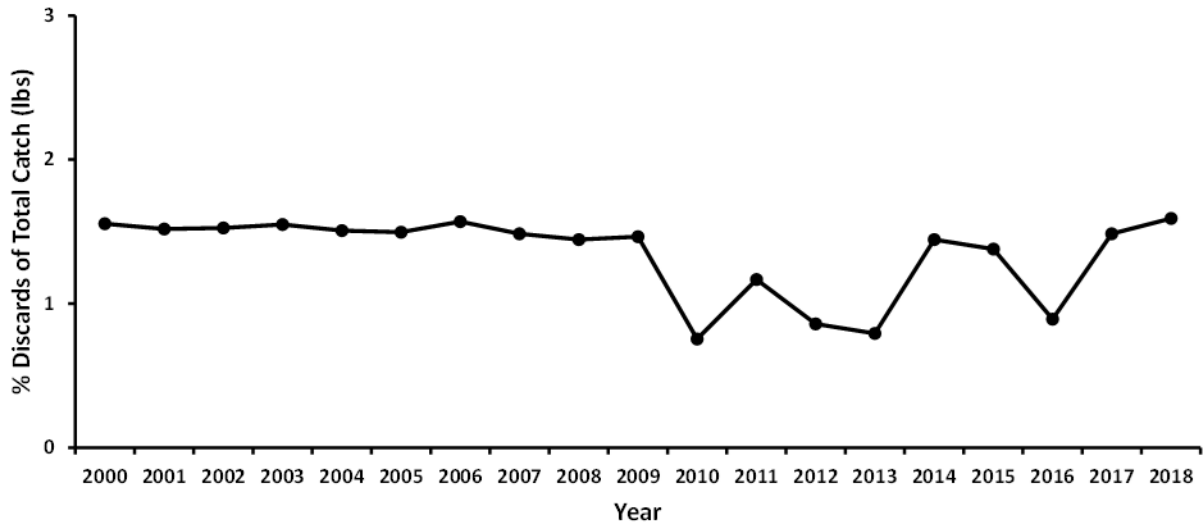

Figure 3.4.2 Observer CPUE expansion estimates of GOM Scamp/Yellowmouth Grouper bottom longline annual discards (\pm SE) in (A) number and (B) weight expressed as percentage of total catch (kept + discards) for 2000-2018.



Figure 3.5.1 Map showing the extent of Southeastern Fisheries Management Region areas for the SEDAR 68 Scamp assessment data compilation.

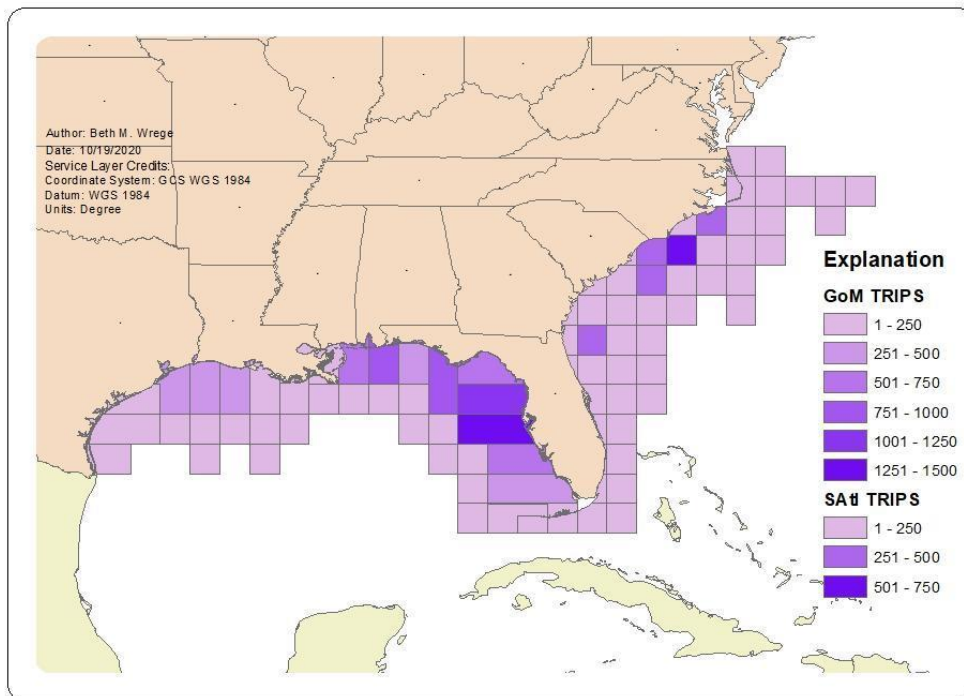

Figure 3.5.2 Map of Total Cumulative Scamp Effort (Trips) 1990 - 2019 in the Gulf of Mexico and South Atlantic (SATL starts in 1992) as reported to CFLP.

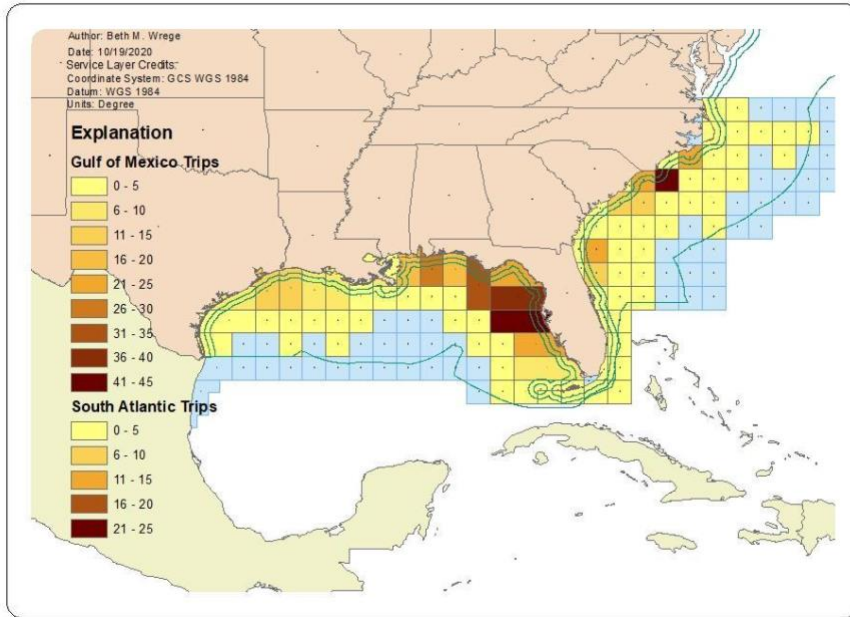
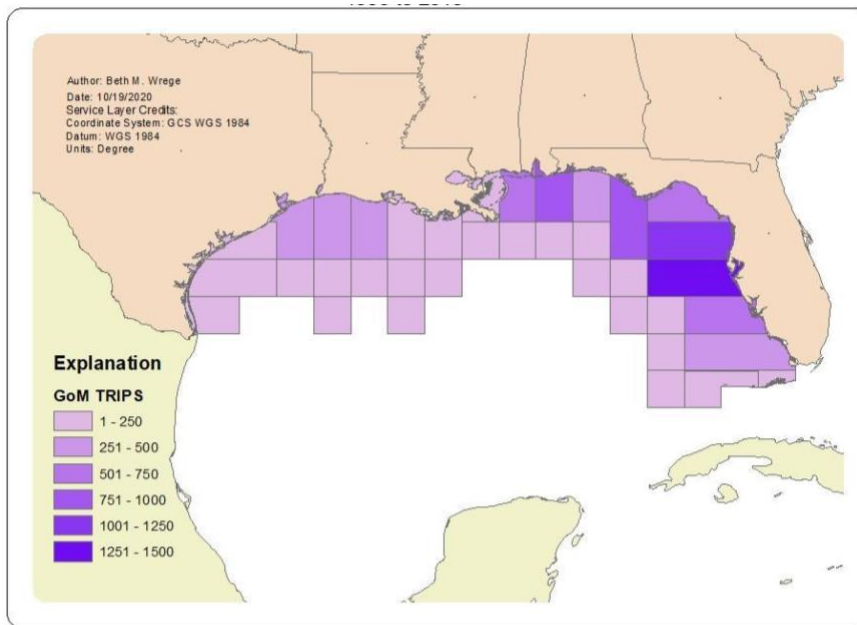

Figure 3.5.3 Map of Mean Annual Scamp Effort (Trips) 1990 - 2019 in the Gulf of Mexico and South Atlantic (SATL starts in 1992) as reported to CFLP.



Map of Scamp effort in the South Atlantic as reported to the CFLP.

Figure 3.5.4 Map of Total Cumulative Scamp Effort (Trips) 1990 - 2019 in the Gulf of Mexico as reported to CFLP.

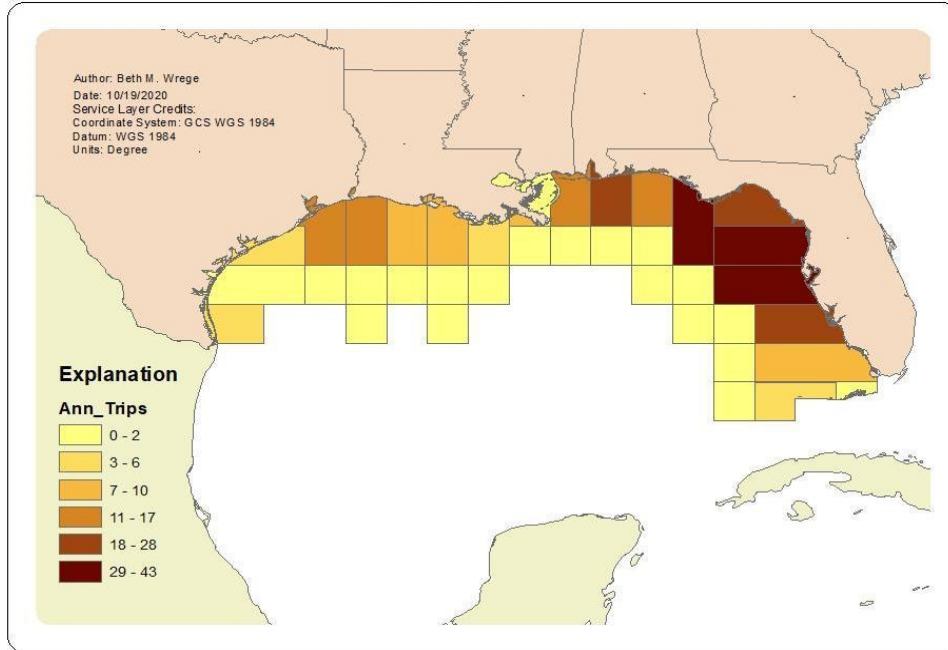

Figure 3.5.5 Map of Mean Annual Scamp Effort (Trips) 1990 - 2019 in the Gulf of Mexico as reported to CFLP.



Figure 3.5.6 Commercial Annual Scamp Effort (in Trips that landed Scamp or Yellowmouth Grouper) 1990 - 2019 in the Gulf of Mexico (GOM) as reported to CLFP.

3.11 APPENDIX A - ALS

NMFS SECPR Accumulated Landings System (ALS)

Information on the quantity and value of seafood products caught by fishermen in the U.S. has been collected starting in the late 1800s (inaugural year is species dependent). Fairly serious collection activity began in the 1920s. The data set maintained by the Southeast Fisheries Science Center (SEFSC) in the SECPR database management system is a continuous dataset that begins in 1962.

In addition to the quantity and value, information on the gear used to catch the fish, the area where the fishing occurred and the distance from shore are also recorded. Because the quantity and value data are collected from seafood dealers, the information on gear and fishing location are estimated and added to the data by data collection specialists. In some states, this ancillary data are not available.

Commercial landings statistics have been collected and processed by various organizations during the 1962-to-present period that the SECPR data set covers. During the 16 years from 1962 through 1978, these data were collected by port agents employed by the Federal government and stationed at major fishing ports in the southeast. The program was run from the Headquarters Office of the Bureau of Commercial Fisheries in Washington DC until 1970. After 1970 it was run by the newly created National Marine Fisheries Service, which had replaced the Bureau of Commercial Fisheries. Data collection procedures were established by Headquarters and the data were submitted to Washington for processing and computer storage. In 1978, the responsibility for collection and processing was transferred to the SEFSC.

In the early 1980s, the NMFS and the state fishery agencies within the Southeast began to develop a cooperative program for the collection and processing of commercial fisheries statistics. With the exception of two counties, one in Mississippi and one in Alabama, all of the General Canvass statistics are collected by the fishery agency in the respective state and provided to the SEFSC under a comprehensive Cooperative Statistics Program (CSP). The purpose of this documentation is to describe the current collection and processing procedures that are employed for the commercial fisheries statistics maintained in the SECPR database.

1960 - Late 1980s

=====

Although the data processing and database management responsibilities were transferred from the Headquarters in Washington DC to the SEFSC during this period, the data collection procedures remained essentially the same. Trained data collection personnel, referred to as fishery reporting specialists or port agents, were stationed at major fishing ports throughout the Southeast Region. The data collection procedures for commercial landings included two parts.

The primary task for the port agents was to visit all seafood dealers or fish houses within their assigned areas at least once a month to record the pounds and value for each species or product type that was purchased or handled by the dealer or fish house. The agents summed the landings

and value data and submitted these data in monthly reports to their area supervisors. All of the monthly data were submitted in essentially the same form.

The second task was to estimate the quantity of fish that were caught by specific types of gear and the location of the fishing activity. Port agents provided this gear/area information for all of the landings data that they collected. The objective was to have gear and area information assigned to all monthly commercial landings data.

There are two problems with the commercial fishery statistics that were collected from seafood dealers. First, dealers do not always record the specific species that are caught and second, fish or shellfish are not always purchased at the same location where they are unloaded, i.e., landed. Dealers have always recorded fishery products in ways that meet their needs, which sometimes make it ambiguous for scientific uses. Although the port agents can readily identify individual species, they usually were not at the fish house when fish were being unloaded and thus, could not observe and identify the fish.

The second problem is to identify where the fish were landed from the information recorded by the dealers on their sales receipts. The NMFS standard for fisheries statistics is to associate commercial statistics with the location where the product was first unloaded, i.e., landed, at a shore-based facility. Because some products are unloaded at a dock or fish house and purchased and transported to another dealer, the actual 'landing' location may not be apparent from the dealers' sales receipts. Historically, communications between individual port agents and the area supervisors were the primary source of information that was available to identify the actual unloading location.

Cooperative Statistics Program

In the early 1980s, it became apparent that the collection of commercial fisheries statistics was an activity that was conducted by both the Federal government and individual state fishery agencies. Plans and negotiations were initiated to develop a program that would provide the fisheries statistics that are needed for management by both Federal and state agencies. By the mid-1980s, formal cooperative agreements had been signed between the NMFS/SEFSC and each of the eight coastal states in the southeast, Puerto Rico and the US Virgin Islands.

Initially, the data collection procedures that were used by the states under the cooperative agreements were essentially the same as the historical NMFS procedures. As the states developed their data collection programs, many of them promulgated legislation that authorized their fishery agencies to collect fishery statistics. Many of the state statutes include mandatory data submission by seafood dealers.

Because the data collection procedures (regulations) are different for each state, the type and detail of data varies throughout the Region. The commercial landings database maintained in SECPR contains a standard set of data that is consistent for all states in the Region.

A description of the data collection procedures and associated data submission requirements for each state follows.

Florida

=====
Prior to 1986, commercial landings statistics were collected by a combination of monthly mail submissions and port agent visits. These procedures provided quantity and value, but did not provide information on gear, area or distance from shore. Because of the large number of dealers, port agents were not able to provide the gear, area and distance information for monthly data. This information, however, is provided for annual summaries of the quantity and value and known as the Florida Annual Canvas data (see below).

Beginning in 1986, mandatory reporting by all seafood dealers was implemented by the State of Florida. The State requires that a report (ticket) be completed and submitted to the State for every trip. Dealers have to report the type of gear as well as the quantity (pounds) purchased for each species. Information on the area of catch can also be provided on the tickets for individual trips. As of 1986 the ALS system relies solely on the Florida trip ticket data to create the ALS landings data for all species other than shrimp.

NMFS SECPR Annual Canvass Data for Florida

The Florida Annual Data files from 1976–1996 represent annual landings by county (from dealer reports) which are broken out on a percentage estimate by species, gear, area of capture, and distance from shore. These estimates are submitted by Port agents, which were assigned responsibility for the particular county, from interviews and discussions from dealers and fishermen collected throughout the year. The estimates are processed against the annual landings totals by county on a percentage basis to create the estimated proportions of catch by the gear, area and distance from shore. The sum of percentages for a given Year, State, County, Species combination will equal 100.

Area of capture considerations: ALS is considered to be a commercial landings database which reports where the marine resource was landed. With the advent of some State trip ticket programs, the definition is more loosely applied. As such one cannot assume reports from the ALS by State or county will accurately inform you of Gulf vs. South Atlantic vs. Foreign catch. To make that determination you must consider the area of capture.

3.12 APPENDIX B

Brief overview on Gulf of Mexico Grouper-Tilefish IFQ programs

Jessica A. Stephen

National Marine Fisheries Service, Southeast Regional Office,

263 13th Ave S, St. Petersburg, FL 33701

Date Written: 12/08/2014

I. Background

The first year of fishing in the Grouper-Tilefish IFQ (GT-IFQ) program began on January 1, 2010. Initial shares were issued based on the amount of grouper-tilefish logbook landings reported under each entity's qualifying permit during 1999 through 2004, with an allowance for dropping one year of data. Initial shares were issued in five different IFQ categories: deep-water grouper, gag, red grouper, other shallow-water grouper, and tilefish. For the first five years of the program, shares and allocation can only be sold to and fished by an entity that owns a valid commercial Gulf reef fish permit and has an active GT-IFQ online account. After January 1, 2015, all U.S. citizens and permanent resident aliens will be eligible to purchase GTIFQ shares and allocation, although a valid Gulf reef fish permit will still be required to harvest, possess, and land any allocation.

The GT-IFQ program is a multi-species program with five share categories: gag, red grouper, other shallow-water groupers, deep-water groupers, and tilefishes. Each share category has distinct shares and associated allocations. Shares are a percentage of the commercial quota, while allocation refers to the poundage that is possessed, landed, or sold during a given calendar year. At the beginning of each year, allocation is distributed based on the annual quota and the share percentages held by a GT-IFQ shareholder account. Allocation can then be used to harvest GT-IFQ species or sold to another valid shareholder account. Adjustments in quota can occur if the status of a stock changes as a result of new assessments or through the reallocation of quota between fishing sectors. Adjustments in quota are distributed proportionately among shareholder accounts based on the percentage of shares each account holds at the time of the adjustment. All transactions (share transfers, allocation transfers, landings, and cost recovery fees) in the GT-IFQ program are completed online.

There are three main account roles in the GT-IFQ system: shareholder, vessel, and dealer accounts. All accounts were assigned to users based on the unique entity (single or combination of individuals and/or business) that held either a Gulf of Mexico (Gulf) dealer or reef fish permit. Shareholder accounts with valid Gulf reef fish permits may transfer GT-IFQ shares and allocation to and from their accounts, as well as land GT-IFQ species at an approved dealer. Shareholder accounts that do not have a valid Gulf reef fish permit can only transfer shares and allocation to other accounts, and may not increase their holdings. A list of all accounts that hold

shares is available through the NMFS Southeast Regional Office (SERO) Freedom of Information Act website. Vessel accounts, which belong to shareholder accounts, only hold allocation that is debited from the account through landing transactions. Shareholder accounts may have multiple vessel accounts. Dealer accounts were assigned to a unique entity that has a valid Gulf reef fish dealer permit, and functions are limited to completing landing transactions and paying cost recovery fees.

The GT-IFQ program has several built-in flexibility measures to accommodate the multi-species nature of the fishery and reduce bycatch. Two share categories, gag and red grouper, have a multi-use provision that allows a portion of the red grouper to be harvested under the gag allocation, or vice versa. The three remaining categories (shallow-water grouper, deep-water grouper, and tilefish) are multiple-species categories, designed to capture species complexes that are commonly caught together. Three grouper species (Scamp, Warsaw grouper, and speckled hind) are found in both shallow and deep water. Flexibility measures in the GT-IFQ program allow for these species to be landed under both share categories. Scamp are designated as a shallow-water grouper species and may be landed using deep-water grouper allocation once all shallow-water grouper allocation in an account has been harvested. Warsaw grouper and speckled hind are designated as deep-water grouper species and may be landed using shallow-water grouper allocation once all deep-water grouper allocation in an account has been harvested. The GT-IFQ program has a built-in flexibility measure to allow a once-per-year allocation overage per share category for any GT-IFQ account that owns shares in that share category. For these accounts, a vessel can land 10% more than their remaining allocation on the vessel. This overage is then deducted from the shareholder's allocation at the start of the following fishing year. Because overages need to be deducted in the following year, GT-IFQ accounts without shares cannot land an excess of their remaining allocation and GT-IFQ accounts with shares are prohibited from selling shares that would reduce the account's shares fewer than the amount needed to repay the overage in the following year.

When harvesting GT-IFQ species, vessels are required to have a GOM reef fish permit, and to hail out before leaving port. While at-sea, vessels are monitored using vessel monitoring systems. When returning to port, vessels landing GT-IFQ species must provide a landing notification indicating the time and location of landing, the intended dealer, and the estimated pounds landed. Landing may occur at any time, but fish may not be offloaded between 6 p.m. and 6 a.m. A landing transaction report is completed by the GT-IFQ dealer and validated by the fisherman. The landing transaction includes the date, time, and location of the transaction; weight and actual ex-vessel value of fish landed and sold; and the identity of shareholder account, vessel, and dealer. For current total GT-IFQ landings go to: <https://portal.southeast.fisheries.noaa.gov/cs/main.html#> and past landings are recorded under 'Additional Documents'. All current landings data are updated in a real-time basis as the landing transaction is processed.

II. Data Description

The GT-IFQ program is a real-time online system, with all transactions recorded immediately upon entry. Data is entered directly by the GT-IFQ participants for all transactions that occur within the system. The GT-IFQ program directly links to the Southeast Regional Office's Permits database in order to validate all vessel and dealer accounts. There are three types of transactions that occur in the GT-IFQ program: share transfer, allocation transfers, and landing transactions. Share transactions contain the following information: transferor, transferee, transaction completion date/time, share category, share percentage transferred, and a confirmation number. Share transfers can only occur between shareholder accounts. Allocation transfers contain similar information as share transfers and include: transferor, transferee, transfer date/time, share category, pounds transferred, and confirmation number. Allocation transfers can occur between a shareholder and his vessel, between two shareholder accounts, or from a shareholder account to another shareholder's vessel account. Landing transactions contain the following information: shareholder account, vessel account, dealer account, landing date/time, landing location, species, pounds, and a landing confirmation number. Additional tables in the GT-IFQ program contain address information for each participant in the GT-IFQ program. The primary contact's address information is used when connecting address information to any transaction.

III. Database Structure

The data is stored in a relational database system that is fishermen-vessel based and accounts are based on unique entities associated with the account, where no account contains the exact same entities as another account. Many vessel accounts may be associated with one shareholder account, if the permit holder is the same on each vessel. This allows the GT-IFQ system to link to the Permits database and establish a validity status for each vessel account. Establishing vessel accounts also allowed IFQ program staff and law enforcement to verify that a vessel has sufficient allocation at the time of a landing notification.

IV. Data Quality

The Vessel Monitoring Systems (VMS) staff provides quality control over GT-IFQ data when vessels are out at sea. Vessels are required to notify VMS staff each time they leave dock (hail out) and complete a landing notification (hail in) prior to landing. While at sea, VMS staff is able to monitor vessel locations hourly to determine if the vessel is fishing in approved areas. GT-IFQ landing notifications can be submitted directly from the GT-IFQ system through VMS units.

The online system has a series of built-in quality assurance measures that reduce the possibility of errors within the system. Pre-designed web-based screens direct the GT-IFQ participants through a detailed process for each transaction. Transactions are not completed until pertinent information has been completed. The system will not allow the completion of any transaction if

any of the participating accounts is in a suspended or inactive status. Share transactions are not completed until verified by both the transferor and transferee. Similarly, landing transactions are not completed until the shareholder enters their vessel personal identification number. In 2012, the system was updated to allow for the selection of the associated 3-hour notification for each landing transaction. Dealers can also enter an associated trip ticket number with an IFQ landing transaction, although this is an optional field currently.

IFQ staff provides additional quality control which includes but is not limited to: adjusting landings based on submitted Landing Correction Forms, and auditing landing notifications and transactions. IFQ staff continues to work with system developers to improve data quality and accuracy and ensure that all web-based screen shots capture required information.

4 RECREATIONAL FISHERY STATISTICS

4.1 OVERVIEW

4.1.1 Group Membership

Members - Ken Brennan (Co-leader/NMFS SEFSC Beaufort), Julia Byrd (SAFMC), Kelly Fitzpatrick (NMFS SEFSC Beaufort), Dominique Lazarre (FWCC, FL), Vivian Matter (Co-leader/NMFS SEFSC Miami), Matthew Nuttall (NMFS SEFSC Miami), Alexandra Smith (CIMAS/NMFS SEFSC Miami), Molly Stevens (NMFS SEFSC Miami)

4.1.2 Tasks

1. Identify potential species misidentification issues
2. Review fully calibrated MRIP FES/APAIS/FHS landings and discard estimates
3. Determine whether MRIP catch estimates from Monroe County belong to the Gulf of Mexico or South Atlantic stock
4. Evaluate MRIP catch estimates by mode of fishing to determine appropriate modes for inclusion in the Scamp assessment
5. Determine when Scamp was included in the SRHS universal logbook form
6. Evaluate usefulness of historical data sources such as the Fishing, Hunting, and Wildlife-Associated Recreation Survey (FHVAR) to generate estimates of landings prior to 1981

7. Provide estimates of uncertainty around each set of landings and discard estimates
8. Review whether SRHS discard estimates (2004+) are reliable for use and determine if there are other sources of data prior to 2004 that could be used as a proxy to estimate headboat discards
9. Provide nominal length distributions for both landings and discards if feasible
10. Evaluate adequacy of available data
11. Provide research recommendations to improve recreational data

4.1.3 Gulf of Mexico Fishery Management Council Scamp Group Management Boundaries

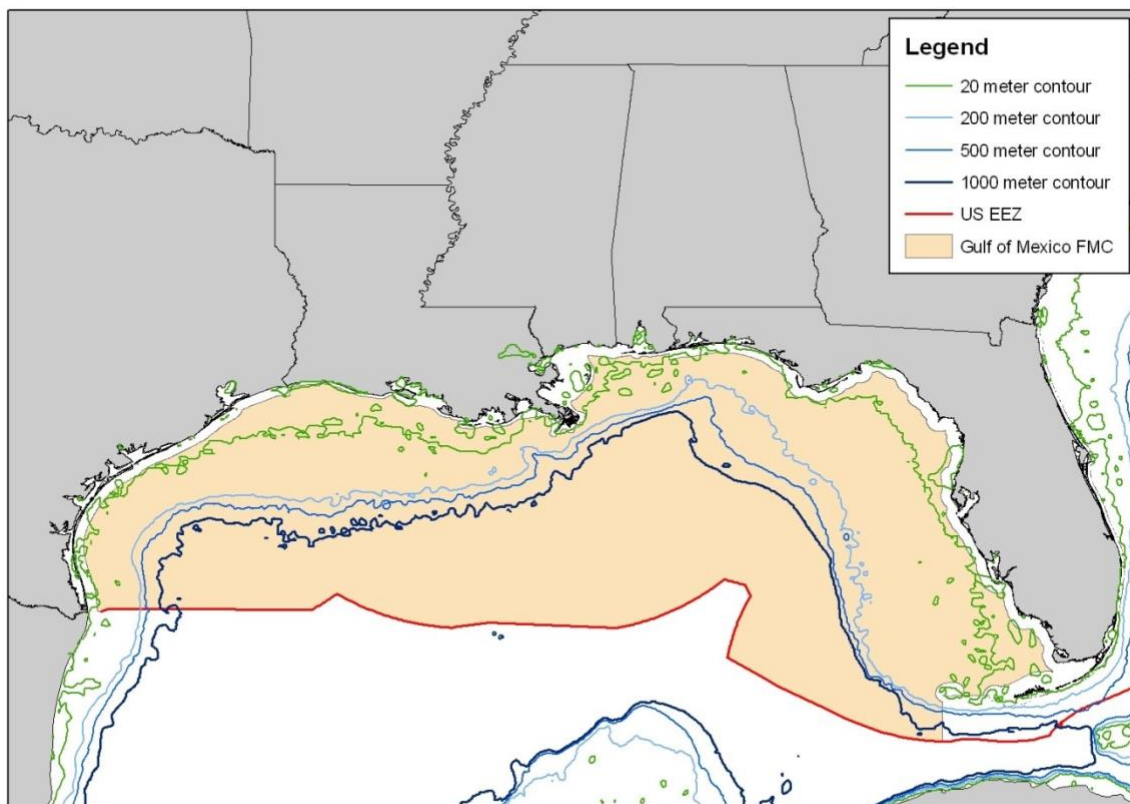

4.1.4 Stock ID Recommendations

Geographic boundaries

The SEDAR 68 Stock ID Workshop “recommended that two stock assessments be conducted, separated by the default boundary between the Gulf of Mexico and Atlantic waters, as defined by the Councils’ jurisdictions” (SEDAR68-SID-05).

Species identification

Task 1: The SEDAR 68 Stock ID Workshop found that “Scamp are very difficult to distinguish from Yellowmouth Grouper, even for trained biologists, and thus much of the assessment data likely represent both species in unknown proportions”. It was recommended that the Scamp assessment “be conducted on both Scamp and Yellowmouth Grouper jointly, with the two species treated as a single complex” (SEDAR68-SID-05). As such, the recreational working group included both Scamp and Yellowmouth Grouper when providing recreational data for this stock assessment. Subsequent references to Scamp in this Recreational Data Workshop report include both Scamp and Yellowmouth Grouper.

4.2 ABSTRACTS OF WORKING PAPERS

Recreational Survey data for Scamp and Yellowmouth Grouper in the Gulf of Mexico (SEDAR 68-DW-09)

General recreational survey data for Scamp and Yellowmouth Grouper from the Marine Recreational Information Program (MRIP), Texas Parks and Wildlife Department (TPWD), and Louisiana Creel Survey (LA Creel) are summarized from 1981 to 2018 for Gulf of Mexico states from Texas to western Florida, not including the Florida Keys. Charter boat, private, shore, and headboat (1981-1985) fishing modes are presented. These estimates include fully calibrated MRIP estimates that take into account the change in the Fishing Effort Survey, the redesigned Access Point Angler Intercept Survey, and the For-hire Survey. Tables and figures presented include calibration comparisons, landing and discard estimates, associated CVs, sample sizes, fish sizes, and effort estimates.

SEFSC computation of variance estimates for custom data aggregations from the Marine Recreational Information Program (SEDAR 68-DW-10)

Coefficient of variation (CV) estimates for Marine Recreational Information Program (MRIP) survey catch totals are provided for stock assessments by the Southeast Fisheries Science Center (SEFSC). Variances of total catch estimates are computed directly from the raw survey data to obtain CVs appropriate for custom aggregations by year, wave, sub-region, state, and mode using standard survey methods.

Estimates of Historic Recreational Landings of Scamp and Yellowmouth Grouper in the Gulf of Mexico Using the FHWAR Census Method (SEDAR 68-DW-12)

The National Survey of Fishing, Hunting, and Wildlife-Associated Recreation Survey (FHWAR) has been conducted every 5 years since 1955 and is one of the oldest and most comprehensive recreational surveys. The FHWAR census method utilizes information from these surveys including U.S. angler population estimates and angling effort estimates from 1955–1985 for the Gulf of Mexico region. To obtain historical Scamp landings prior to 1981, estimated saltwater angler trips (1955-1980) are multiplied by average catch rates that are calculated from early years (1981-1985) of recreational data. Interpolation is used to complete time series.

Marine Recreational Information Program Metadata for the Atlantic, Gulf of Mexico, and Caribbean regions (SEDAR 68-DW-13)

The Marine Recreational Information Program (MRIP), formerly the Marine Recreational Fisheries Statistics Survey (MRFSS), is conducted by the NOAA National Marine Fisheries Service (NMFS) to provide estimates of catch per unit effort, total effort, landings, and discards for six two-month periods (waves) per year. MRIP provides estimates for three main recreational fishing modes: shore-based fishing, private and rental boat fishing, and for-hire charter boat and guide boat fishing. MRIP also provides estimates for the headboat mode in the mid and north Atlantic regions and in the early years (1981-1985) in the South Atlantic and Gulf of Mexico. Methodologies through time, spatiotemporal coverage, and field descriptions are summarized in this metadata paper.

A Summary of Observer Data from the Size Distribution and Release Condition of Scamp Discards from Recreational Fishery Surveys in the Eastern Gulf of Mexico (SEDAR 68-DW-24)

This report summarizes available size distribution and release condition data for Scamp and Yellowmouth Grouper captured in the for-hire fleets (Headboats and Charter boats) operating along the Gulf coast of Florida.

SEFSC Computation of Uncertainty for Southeast Regional Headboat Survey and Total Recreational Landings Estimates (SEDAR 68-DW-31)

Coefficient of variation (CV) estimates for recreational catch totals are provided as uncertainty measures for use in stock assessments by the Southeast Fisheries Science Center (SEFSC). Variances for landings estimates from the Southeast Region Headboat Survey (SRHS) are calculated at the vessel level from reported logbook landings. Uncertainty in total recreational landings are calculated as the sum total of variances from reported SRHS logbook landings and landings data from the Marine Recreational Information Program.

Discards of Scamp (*Mycteroperca phenax*) for the headboat fishery in the US Gulf of Mexico (SEDAR 68-DW-33)

The Southeast Region Headboat Survey (SRHS) was modified in 2004 to collect self-reported discards for each reported trip. These self-reported data are currently not validated within the SRHS. The SRHS discard proportions were compared to the MRIP At-Sea Observer program discard proportions for validation purposes and to determine whether the SRHS discard estimates should be used for a full or partial time series (2004-2018). Discard estimates prior to 2004 are calculated using a proxy method. For Scamp, MRIP CH mode, MRIP PR mode, and the mean MRIP CH:SRHS discard ratio method were considered as sources for proxy discard estimates for headboat discards. Due to variability in the MRIP CH mode and PR mode discard and landings estimates, a mean SRHS discard ratio method was also considered, as well as a three year rolling average of the MRIP CH mode and mean MRIP CH:SRHS discard ratio method.

4.3 RECREATIONAL DATA SOURCES

4.3.1 *Marine Recreational Information Program (MRIP)*

Introduction

The Marine Recreational Information Program (MRIP), formerly the Marine Recreational Fisheries Statistics Survey, conducted by NOAA Fisheries (NMFS) provides estimates of catch per unit effort, total effort, landings, and discards for six two-month periods (waves) each year. MRIP provides estimates for three main recreational fishing modes: shore-based fishing (Shore), private and rental boat fishing (Priv), and for-hire charter boat and guide boat fishing (Cbt). MRIP also provides estimates for headboat mode (Hbt) in the mid and north Atlantic regions. MRIP covers all Gulf of Mexico states from western Florida to Mississippi. Louisiana was covered by the survey until 2014. Texas does not participate in MRIP as the state conducts its own recreational survey (discussed below in 4.3.2). When the survey first began in Wave 2 (Mar/Apr) of 1981, headboats were included in the for-hire mode, but were excluded after 1985 to avoid overlap with the Southeast Region Headboat Survey (SRHS), conducted by the NMFS Beaufort laboratory.

Recreational catch, effort, and participation were estimated through a suite of independent but complementary surveys that are described in SEDAR 68-DW-13. Over the years, effort data have been collected from three different surveys: (1) the Coastal Household Telephone Survey (CHTS) which used random digit dialing of coastal households to obtain information about recreational fishing trips, (2) the weekly For-Hire Survey which interviews charter boat operators (captains or owners) to obtain trip information and replaced the CHTS for the charter boat mode (in 2000 for the Gulf of Mexico and East Florida and 2004 for the Atlantic coast north of Georgia), and (3) the Fishing Effort Survey which is a mail based survey whose sample frame consists of anglers from the National Saltwater Angler Registry and replaced the CHTS for the private and shore modes in 2018. Catch data are collected through dockside angler interviews in the Access Point Angler Intercept Survey (APAIS), which samples recreational fishing trips after they have been completed. In 2013, MRIP implemented a new APAIS to remove sources of potential bias from the sampling process. Catch rates from dockside intercept surveys are combined with estimates of effort to estimate total landings and discards by wave, mode, and area fished (inland, state, and federal waters). Catch estimates from early years of the survey are highly variable with high proportional standard errors (PSE's). Sample sizes in the dockside intercept portion have been increased over time to improve precision of catch estimates.

Task 2: In order to maintain a consistent time series, charter boat estimates were calibrated on the Gulf coast prior to 2000 (SEDAR64-RD-12). CHTS and calibrated FHS charter boat catch estimates for Gulf of Mexico Scamp from 1981 to 1999 are shown in Figure 1 of SEDAR 68-DW-09. Calibrated APAIS and FES estimates for Gulf of Mexico Scamp from 1981 to 2018 are shown in Figure 2 of SEDAR 68-DW-09.

Monroe County

Monroe County MRIP landings are included in the official West Florida estimates. However, they can be estimated separately using domain estimation. The Monroe County domain includes only intercepted trips returning to that county as identified in the intercept survey data. Estimates are then calculated within this domain using standard design-based estimation which incorporates the MRIP design stratification, clustering, and sample weights (SEDAR68-DW-13). Although Monroe county estimates can be separated using this process, they cannot be partitioned into those from the Atlantic Ocean and those from the Gulf of Mexico (SEDAR-PW-07).

Task 3: For SEDAR 68, MRIP Scamp landings from Monroe County were allocated to the South Atlantic region because it is more likely that this deep-water species would be caught on the Atlantic side of the Florida Keys than the Florida Bay side.

Adjustment to Fishing Modes

Task 4a: Between 1981 and 1985, MRIP charter boat and headboat modes were combined into a single mode for estimation purposes. Since the NMFS Southeast Region Headboat Survey (SRHS) began in the Gulf in 1986, the MRIP combined charter boat/headboat mode must be split in order to provide estimates of headboat landings in these early years. The MRIP charter boat /headboat mode (1981-1985) was split by using a ratio of SRHS headboat angler trip estimates to MRIP charter boat angler trip estimates for 1986-1990. In accordance with SEDAR Best Practices, the mean ratio was calculated by state (or state equivalent to match SRHS areas to MRIP states) and then applied to the 1981-1985 estimates to split out the headboat component (SEDAR-PW-07). The MRIP headboat component from this split was used to represent headboat fishing in the Gulf (West Florida to Louisiana) from 1981-1985. Since Texas does not participate

in MRIP, headboat estimates from Texas for these early years are informed from SRHS (discussed below in 4.3.4). SRHS estimates represent headboat fishing starting in 1986 for all Gulf states.

Task 4b: The working group also discussed the validity of the MRIP shore mode estimates for Gulf of Mexico Scamp. The working group recommended that all shore mode estimates be excluded because:

- Shore landings are sporadic and generally extremely low compared to other modes or based on only a few intercepts that have expanded the estimates greatly
- Scamp are primarily a deep-water species
- Legal sized fish aren't likely to be caught during a shore trip
- Scamp identified during shore mode trips may be a result of misidentification

Uncertainty

Coefficient of variation (CV) estimates for Marine Recreational Information Program (MRIP) survey catch totals are provided for stock assessments by the Southeast Fisheries Science Center (SEFSC). Variances of total catch estimates are computed directly from the raw survey data to obtain CVs appropriate for custom aggregations by year, wave, sub-region, state, and mode using standard survey methods (SEDAR 68-DW-10).

4.3.2 Texas Parks and Wildlife Department's (TPWD) Marine Sport-Harvest Monitoring Program

The TPWD Sport-Boat Angling Survey samples fishing trips made by sport-boat anglers fishing in Texas marine waters. All sampling takes place at recreational boat access sites. The raw data include information on catch, effort and length composition of the catch for sampled boat-trips. These data are used by TPWD to generate recreational catch and effort estimates starting in May 1983 (SEDAR 70-WP-03). The survey is designed to estimate landings and effort by high-use (May 15-November 20) and low-use seasons (November 21-May 14). Since SEDAR 16 in 2008, SEFSC personnel have disaggregated the TPWD seasonal estimates into waves (2 month periods) using the TPWD intercept data. This was done to make the TPWD time series compatible with the MRIP time series. TPWD surveys private and charter boat fishing trips. While TPWD samples all trips (private, charter boat, ocean, bay/pass), most of the sampled trips

are associated with private boats fishing in bay/pass, as these trips represent most of the fishing effort. Charter boat trips in ocean waters are the least encountered in the survey. Additional information on the TPWD survey can be found in SEDAR 70-WP-03.

4.3.3 Louisiana Creel Survey (LA Creel)

The Louisiana Department of Wildlife and Fisheries (LDWF) began conducting the Louisiana Creel (LA Creel) survey program on January 1, 2014 to monitor marine recreational fishery catch and effort. Private and charter boat modes of fishing are sampled. The program is comprised of three separate surveys: a shoreside intercept survey, a private telephone survey, and a for-hire telephone survey. The shoreside survey is used to collect data needed to estimate the mean numbers of fish landed by species for each of five different inshore basins and one offshore area. The private telephone survey samples from a list of people who possess either a LA fishing license or a LA offshore fishing permit and provided a valid telephone number. The for-hire telephone survey samples from a list of Louisiana's registered for-hire captains who provided a valid telephone number. Both telephone surveys are conducted weekly. Discard information has been collected since 2016 but only for a subset of finfish species; Scamp are not a target species of the LA Creel survey.

4.3.4 Southeast Region Headboat Survey (SRHS)

The Southeast Region Headboat Survey estimates landings and effort for headboats in the South Atlantic and Gulf of Mexico. The Headboat Survey incorporates two components for estimating catch and effort. 1) Information about the size of fish landed is collected by port samplers during dockside sampling, where fish are measured to the nearest mm and weighed to the nearest 0.01 kg. These data are used to generate mean weights for all species by area and month. Port samplers also collect otoliths for ageing studies during dockside sampling events. 2) Information about total catch and effort are collected via the logbook, a form filled out by vessel personnel and containing total catch and effort data for individual trips. These logbooks are summarized by vessel to generate estimated landings by species, area, and time strata.

The SRHS began in 1972 in North Carolina and South Carolina. In 1975 the SRHS expanded to northeast Florida (Nassau-Indian River counties), followed by Georgia in 1976, and southeast Florida (St. Lucie-Monroe counties) in 1978. In 1986 the survey expanded to include west

Florida, Alabama, Louisiana, and Texas. Mississippi was added to the survey in 2010. For SEDAR 68, only data from western Florida through Texas were included. Due to headboat area definitions and confidentiality issues, estimates of SRHS catch are combined for: (i) Texas, Louisiana, and Mississippi and (ii) Alabama and western Florida. The portion of the SRHS covering the Gulf of Mexico generally includes 70-80 vessels participating in the area annually.

Uncertainty

As an associated measure of uncertainty for landings estimates from the Southeast Region Headboat Survey (SRHS), the variance in reported landings from SRHS logbooks is computed at the vessel level for each area-month strata. Because the SRHS is designed to be a census, this calculation also includes a finite population correction factor where uncertainty equals zero when the entire headboat fleet is covered by the survey (i.e., reported landings = actual landings). Details of this approach are outlined in SEDAR 68-DW-31.

4.3.5 Headboat At-Sea Observer Survey

An observer survey of the recreational headboat fishery was launched in NC and SC in 2004 and in GA and FL in 2005 to collect more detailed information on recreational headboat catch, particularly for discarded fish. Sampling in western FL was discontinued in 2008 but started again in June 2009, and started to include sampling of the charter boat fleet. The coverage for both fleets continued through 2017. Headboat and charter boat vessels were randomly selected throughout the year in each state. Biologists board selected vessels with permission from the captain and observe anglers as they fish on the recreational trip. Data collected include the species, number, final disposition, and size of landed and discarded fish. Data are also collected on the length of the trip and area fished (inland, state, and federal waters) (SEDAR 68-DW-24).

4.4 RECREATIONAL LANDINGS

4.4.1 MRIP Landings

Weight Estimation

The Southeast Fisheries Science Center used the MRIP sample data to obtain an average weight by strata using the following hierarchy: species, region, year, state, mode, wave, and area (SEDAR32-DW-02). The minimum number of weights used at each level of substitution is 15

fish, except for the final species level where the minimum is 1 fish (SEDAR67-WP-06). Average weights are then multiplied by the landings estimates in numbers to obtain estimates of landings in weight. These estimates are provided in pounds whole weight.

Landing Estimates

Final MRIP landings estimates and associated coefficients of variation, in numbers of fish, are shown by year and mode in Table 3 of SEDAR 68-DW-09 and by year in Table 5 of SEDAR 68-DW-09. Estimates are provided by year and mode for all Gulf of Mexico states from Texas to western Florida, excluding the Florida Keys. Final MRIP landings estimates in pounds whole weight are shown by year and state in Table 6 of SEDAR 68-DW-09 (MRIP landings for LA through 2003 and FLW to MS for all years).

4.4.2 TPWD Landings

TPWD average estimates from 1983 to 1985 (by wave and mode) are typically used to fill in the missing estimates for Texas charter boat and private boat fishing from 1981 until the survey starts in May 1983. However, due to sparse TPWD Scamp estimates in 1983-1985, Scamp landings between 1981 and May 1983 are considered negligible. TPWD estimates of Scamp landings from 1983 to 2018 are provided in Table 1 of SEDAR 68-DW-09.

4.4.3 LA Creel Landings

Starting in 2014, recreational data for Louisiana are only available from the LA Creel survey. LA Creel landings estimates for Louisiana Scamp (2014-2018) are provided in Table 1 of SEDAR 68-DW-09.

4.4.4 SRHS Headboat Logbook Landings

The headboat logbook has changed multiple times throughout the history of the SRHS. In the case of Scamp, both Scamp and Yellowmouth Grouper were included on the SRHS logbooks used throughout the Gulf since 1986.

Task 5: Since the SRHS has had a universal logbook form that included Scamp and Yellowmouth Grouper for all Gulf of Mexico headboat areas since 1986, the SRHS estimates for this assessment will start in 1986.

Landing Estimates

Final SRHS landing estimates are shown in Table 4.12.1. Headboat landing estimates from 1981-1985 come from the MRIP survey for all states except Texas. Headboat landings for Texas 1981 to 1985 were estimated using a 5 year average (1986-1990) from SRHS Texas landings.

4.4.5 Historic Recreational Landings

Introduction

The historic recreational landings time period is defined as pre-1981 for the charter boat, headboat, and private fishing modes, which represents the start of the Marine Recreational Information Program (MRIP) and availability of landings estimates for Scamp. The Recreational Working Group was tasked with evaluating historical sources and methods to compile landings estimates for Scamp prior to 1981.

FHWAR Census Method

The 2001 National Survey of Fishing, Hunting, and Wildlife-Associated Recreation (FHWAR) presents summary tables of U.S. population estimates, along with estimates of hunting and fishing participation and effort from surveys conducted by the US Fish and Wildlife Service every 5 years from 1955 to 1985 (SEDAR 68-DW-12). This information was used to develop an alternative method for estimating recreational landings prior to 1981.

The two key components from these FHWAR surveys that were used in this census method were the estimates of U.S. saltwater anglers and U.S. saltwater days. These estimates are used to calculate the historical effort of Gulf of Mexico saltwater anglers. The mean CPUE from the MRIP estimates from 1981 to 1985 for Scamp is then applied to the historical effort estimates for Gulf of Mexico anglers to provide estimates of recreational Scamp landings prior to 1981 (Table 4.12.2).

Task 6: Historical Scamp landings are available from 1955-1980

- Option 1: Use historical Scamp landings from the FHWAR method (Table 4.12.2; 1955-1980) and non-historical Scamp landings estimates from the MRIP, SRHS, TPWD, and LA Creel surveys (1981-2018), shown in Figure 1 of SEDAR 68-DW-12.
- Option 2: Use only non-historical Scamp landings estimates (1981-2018)

The SEDAR 68 recreational working group recommended to include historical landings estimates from the FHWAR method (option 1) because this method has been accepted as a best practice for SEDARs and is the most representative method available for characterizing recreational landings prior to standardized data collection programs.

4.4.6 Total Recreational Landings

Combined landings estimates (MRIP, SRHS, TPWD, and LA Creel) are shown in Table 4.12.3, Figure 4.13.1, and mapped in Figure 4.13.2. The majority of the recreational Scamp landings in the Gulf of Mexico come from the private mode (about 65%). The charter boat mode contributes about 30% and the headboat mode is almost negligible (about 5%). Geographically, landings mostly come from West Florida (about 80%), followed by Alabama (about 10%). Scamp landings estimates show a major decline in the late 1980s and remained low throughout the 1990s. Scamp landings have generally increased since the early 2000s, with some decline in late 2000s and the most recent years.

Uncertainty

Task 7: To provide an associated measure of uncertainty for total recreational landings estimates, coefficients of variation (CVs) are calculated from the sum total of variance in reported SRHS logbook landings and MRIP landings data. Details of this approach are outlined in SEDAR 68-DW-31.

4.5 RECREATIONAL DISCARDS

4.5.1 MRIP Discards

Fish reported to have been discarded alive are not seen by MRIP interviewers and so neither the identity nor the quantities of discarded fish can be verified. The size and weight of discarded fish are also unknown for all modes of fishing. MRIP discard estimates and associated coefficients of

variation, in numbers of fish, are shown by year and mode in Table 4 of SEDAR 68-DW-09 and by year in Table 5 of SEDAR 68-DW-09. Estimates are provided by year and mode for all Gulf of Mexico states from Texas to western Florida, excluding the Florida Keys.

The working group investigated the 2010 discards estimate, which is the highest estimate in the time series. The estimate of 232,070 fish for that year came primarily from West Florida, private mode, and ocean greater than 10 miles during two different waves:

- Wave 1- Six trips resulted in a discards estimate of 54,354 fish
 - Four trips released three live fish
 - Two trips released one live fish
- Wave 5- Seven trips resulted in a discards estimate of 93,486 fish
 - One trip released thirteen live fish
 - One trip released twelve live fish (and landed six fish, seen by an interviewer)
 - One trip released eleven live fish
 - Two trips released five live fish
 - One trip released five live fish (and landed two fish, seen by an interviewer)
 - One trip released one live fish

4.5.2 LA Creel Discards

Scamp are not a target species of the LA Creel survey and so discard estimates are not provided. However, since Louisiana MRIP discards from 1981 to 2013 are sparse and negligible relative to the Gulf-wide discards estimates, Louisiana Scamp discards since 2014 are also considered negligible.

4.5.3 TPWD Discards

Self-reported catch is not monitored by the TPWD survey and so Texas discards are not estimable from this survey (SEDAR 70-WP-03). Typically, MRIP/LA Creel discard ratios (Gulf-wide or LA) are applied to the TPWD landings as a proxy (SEDAR-PW-07). However, because Scamp landings from the TPWD are negligible, discards of Scamp from Texas are also assumed to be negligible.

4.5.4 Headboat At-Sea Observer Survey Discards

Self-reported headboat discards (discussed in 4.5.5) are not currently validated within the SRHS. However, discard information from the At-Sea Observer Survey is used to validate the SRHS discard estimates and determine whether SRHS discards should be used for the entire time series (2004-2018) or for a partial time series. In the Gulf of Mexico, the At-Sea Observer Survey operates mainly in west Florida, with limited coverage in Alabama in certain years. No trips were sampled in the At-Sea Observer Survey in 2008. In the SRHS, 14,204 Scamp logbook records were collected in the Gulf of Mexico from 2004-2018. Of these records, 6,181 trips reported discards of Scamp. In the At-Sea Observer Program, only 495 observed trips were positive for Scamp, 437 of which had Scamp discards. Due to the differences in magnitude of the number of trips sampled within the At-Sea Observer Program and SRHS, the discard proportion was compared only for those trips where Scamp were discarded. The SRHS and At-Sea Observer discard proportions exhibit the same pattern and degree of magnitude (SEDAR68-DW-33, 2020). Therefore, the SEDAR 68 recreational working group recommended using SRHS discard estimates for 2004-2018.

4.5.5 SRHS Headboat Logbook Discards

The Southeast Region Headboat Survey logbook form was modified in 2004 to include a category to collect self-reported discards for each reported trip. This category is described on the form as the number of fish by species released alive and number released dead. Port agents instructed each captain on criteria for determining the condition of discarded fish. A fish is considered “released alive” if it is able to swim away on its own. If the fish floats off or is obviously dead or unable to swim, it is considered “released dead”. As of Jan 1, 2013, the SRHS began collecting logbook data electronically. Changes to the trip report were also made at this time, one of which removed the condition category for discards (i.e., released alive vs. released dead). The form now collects only the total number of fish released, regardless of condition.

Due to the lack of a Scamp size limit in federal waters of the Gulf of Mexico, it is assumed that discards were negligible prior to 2000. Florida did have a size limit in the 1990s, however, an analysis of the length data showed no impact on the size distribution of the landings (discussed below in 4.6.1.4). The MRIP charter boat mode, MRIP private mode, and mean MRIP CH:SRHS discard ratio method (SEDAR 28 Assessment Workshop Report, 2013) were considered as

sources for proxy discard estimates for headboat discards 2000-2003. Due to variability in the MRIP charter boat mode and private mode discard and landings estimates, a mean SRHS discard ratio method was also considered, as well as a three year rolling average of the MRIP charter boat mode and mean MRIP CH:SRHS discard ratio method (SEDAR68-DW-33).

Task 8: Proxy for estimated headboat discards from 2000-2003

- Option 1: Apply the MRIP private boat discard:landings ratio to estimated headboat landings to estimate headboat discards from 2000-2003.
- Option 2: Apply the MRIP charter boat discard:landings ratio to estimated headboat landings to estimate headboat discards from 2000-2003.
- Option 3: Apply a three year rolling average MRIP charter boat discard:landings ratio to estimated headboat landings to estimate headboat discards (2000-2003).
- Option 4: Mean MRIP CH:SRHS discard ratio method: Calculate the ratio of the mean ratio of SRHS discard:landings (2004-2018) and MRIP CH discard:landings (2004-2018). Apply this ratio to the yearly MRIP charter boat discard:landings ratio (2000-2003) to estimate the yearly SRHS discard:landings ratio (2000-2003). This ratio is then applied to the SRHS landings (2000-2003) to estimate headboat discards (2000-2003).
- Option 5: Apply a three year rolling average of the mean MRIP CH:SRHS discard ratio method to estimated headboat landings to estimate headboat discards (2000-2003).
- Option 6: Apply a mean SRHS discard:landings ratio (2004-2008) to estimated headboat landings to estimate headboat discards (2000-2003).
- Option 7: Apply a mean SRHS discard:landings ratio (2004-2018) to estimated headboat landings to estimate headboat discards (2000-2003).

For years prior to 2004, the working group recommended option 7 as a proxy method for SRHS headboat discards because the MRIP private and charter boat modes showed highly variable discard ratios which did not agree with the SRHS discard ratios and were not recommended for use. The variability within the MRIP charter boat mode discard ratios in turn affected the mean

MRIP CH:SRHS discard ratio method. In an effort to reduce the variability of the MRIP charter boat mode and MRIP CH:SRHS discard ratio methods, a three year rolling average discard ratio from each method was applied to the SRHS landings estimates. A mean SRHS discard:landings ratio was also examined, using a mean of years 2004-2008 and 2004-2018. The MRIP charter boat mode three year rolling average, mean MRIP CH:SRHS discard ratio method three year rolling average, mean SRHS discard ratio (2004-2008), and mean SRHS discard ratio (2004-2018) were compared to the SRHS discard estimates (SEDAR68-DW-33). The cross correlation analysis was used to first determine if lagging the discard estimates with the landings would identify a stronger relationship (strong year class in one year (discards) could be seen in following years (landings)), and secondly provide an objective approach to identify a preferred recommendation. A lag of zero had the highest correlation for the Gulf of Mexico. The mean SRHS discard ratio (2004-2018) method had the strongest relationship with the landings with a lag of zero for the Gulf of Mexico. Therefore, the mean SRHS discard ratio (2004-2018) method was recommended as the proxy method for SRHS discard estimates.

Discard Estimates

Final estimated discards (2004-2018) are presented in Table 4.12.4 along with the proxy discard estimates (2000-2003). Discards of Scamp are nearly negligible west of Alabama. SRHS discards in FLW/AL vary through time and correspond to fluctuations in the SRHS landings and effort.

4.5.6 Total Recreational Discards

Combined discard estimates (MRIP, SRHS, TPWD, and LA Creel) are shown in Table 4.12.5, Figure 4.13.3, and mapped in Figure 4.13.4. Due to the recommendation for SRHS discards to start in 2000 (section 4.5.5), MRIP headboat discards from 1981-1985 were not included in the final discard estimates. The vast majority of the recreational discards in the Gulf of Mexico come from the private mode (about 95% of the discards by mode) and from West Florida (about 90% of the discards by state). Discard estimates for Scamp have generally increased since the late 1990s with considerable inter-annual variability.

4.6 BIOLOGICAL SAMPLING

4.6.1 Landings

4.6.1.1 MRIP Biological Sampling

The MRIP angler intercept survey includes the collection of fish lengths from the harvested catch (landed, whole condition). Up to 15 of each landed species per angler interviewed are measured to the nearest mm along a centerline (defined as tip of snout to center of tail along a straight line, not curved over body). In those fish with a forked tail, this measure would typically be referred to as a fork length. In those fish that do not have a forked tail, it would typically be referred to as a total length, with the exception of some fish that have a single, or few, caudal fin rays that extend further. Weights are typically collected for the same fish measured, although weights are preferred when time is constrained. Ageing structures and other biological samples are not collected during MRIP assignments because of concerns over the introduction of bias to survey data collection due to the time required to collect aging structures. Discarded fish size is unknown for all modes of fishing covered by MRIP.

Summaries of fish size for MRIP-sampled Scamp in the Gulf of Mexico by state (1981-2018) are provided in Table 4.12.6 (pounds whole weight) and Table 7 of SEDAR 68-DW-09 (millimeters fork length). Comparable summaries of fish size by mode are provided in Table 10 of SEDAR 68-DW-09 (pounds whole weight) and Table 9 of SEDAR 68-DW-09 (millimeters fork length). These summaries include the number of measured Scamp, number of angler trips from which Scamp were measured, and the minimum, average, and maximum size of all measured Scamp.

4.6.1.2 TPWD Biological Sampling

Length composition of the catch of Texas sport-boat anglers has been sampled by the TPWD since the high-season of 1983 (mid-May). Total length is measured by compressing the caudal fin lobes dorsoventrally to obtain the maximum possible total length. Weights of sampled fish are not recorded, but lengths can be converted to weights using a length-weight equation (SEDAR 70-WP-03).

Summaries of fish size, in millimeters total length, for TPWD-sampled Scamp in the Gulf of Mexico by mode (1983-2018) are provided in Table 12 of SEDAR 68-DW-09. These summaries include the number of measured Scamp, number of angler trips from which Scamp were measured, and the minimum, average, and maximum size of all measured Scamp.

4.6.1.3 SRHS Biological Sampling

Lengths were collected by headboat dockside samplers beginning in 1972. From 1972 to 1975, only North Carolina and South Carolina were sampled whereas Georgia and northeast Florida sampling began in 1976. The SRHS conducted dockside sampling throughout the southeast portion of the US (from the NC-VA border to the Florida Keys) beginning in 1978. SRHS dockside sampling has been conducted in all Gulf states since 1986, except for Mississippi where sampling started in 2010. Weights are typically collected for the same fish measured during dockside sampling. Biological samples (scales, otoliths, spines, stomachs, and gonads) are also collected routinely and processed for aging, diet studies, and maturity studies.

Summaries of fish size, in kilograms whole weight, for SRHS-sampled Scamp in the Gulf of Mexico (1986-2018) are provided in Table 4.12.7. These summaries include the annual number of measured Scamp, the number of trips from which Scamp were measured, and the minimum, average, and maximum size of Scamp measured by SRHS dockside samplers.

Any existing total length measurements without an associated fork length measurement were converted using the following equation derived by the Life History Working Group for the Gulf of Mexico stock at the SEDAR 68 Data Workshop:

$$FL_mm = 17.74 + 0.89 * TL_mm$$

Any existing whole weight measurements without an associated fork length measurement were converted using the following equation derived by the Life History Working Group for the Gulf of Mexico stock at the SEDAR 68 Data Workshop:

$$FL_mm = 417.17(WW_kg)^{0.31}$$

4.6.1.4 Nominal Length Frequency Distributions of Landings

Task 9: Nominal length frequencies were generated for recreational data by mode and source. Length compositions were shown aggregated by management period for the headboat, charter boat, and private fleets. There were 4 distinct management periods for minimum size limits in Florida: (1) 1981-1989, no minimum size limits; (2) 1990-1999, 20" TL in state waters and no size limit in federal waters; (3) 2000-2003, 20" TL in state waters and 16" TL in federal waters; (4) 2004-2018, 16" TL size limit. These length compositions indicate that only the federal

regulations had an impact on the length frequency distribution of Scamp and Yellowmouth Grouper landings in Florida (Figure 4.13.5). This is consistent with anecdotal knowledge that these species tend to be caught in deeper waters outside of state jurisdiction. The length frequencies pre- and post- federal size limit for the Gulf are provided by fleet in Figure 4.13.6.

4.6.1.5 Aging Data

Age samples are collected as part of the SRHS sampling protocol. Age samples collected from the private/rental boat, charter boat, and shore modes are not typically collected as part of the MRIP sampling protocol. These samples come from a number of sources including state agencies, special projects, and sometimes as add-ons to the MRIP survey. The number of Scamp aged from the recreational fishery by year, state, and mode is summarized in Table 4.12.8. The recreational landings ages will be weighted by the length frequency distributions by year and fleet.

4.6.2 Discards

4.6.2.1 Headboat At-Sea Observer Survey Biological Sampling

At-sea sampling of headboat (starting in 2005) and charter boat (starting in 2009) discards were initiated as part of the improved for-hire surveys to characterize the size distribution of live discarded fish in the headboat fishery.

4.6.2.2 Nominal Length Frequency Distributions of Discards

Length measurements from 1,684 discarded fish were used to generate headboat and charter boat discard length frequency distributions. The headboat length data were weighted by trip duration and region to account for differences in sampling frequency across the Gulf coast of Florida. Charter boat length data were not weighted. The distributions for the headboat and charter boat fleets are very similar, with both fleets showing that releases appear to be regulatory discards (Figure 4.13.7). The group recommended the use of the weighted length distribution for the headboat fleet, as it corrects for under or over-sampling. While the charter boat length data are un-weighted, they provide additional discard information for the charter boat fleet. A full accounting of the weighting procedure applied to the raw length data is provided in SEDAR 68-DW-24.

4.7 RECREATIONAL EFFORT

4.7.1 MRIP Effort

MRIP effort estimates are produced via the Fishing Effort Survey (FES) for private/rental boats and shore mode and the For-Hire Survey (FHS) for charter boat mode. MRIP effort is calculated in units of angler trips, which represents a single day of fishing in the specified mode that does not exceed 24 hours and is provided by year in Table 13 of SEDAR 68-DW-09. This table includes MRIP effort estimates for Louisiana until 2013, Mississippi, Alabama, and western Florida, excluding the Florida Keys.

4.7.2 TPWD Effort

Texas effort estimates (in angler trips) are provided in Table 13 of SEDAR 68-DW-09 for years 1983-2018.

4.7.3 LA Creel Effort

Louisiana effort estimates (in angler trips) are provided by LA Creel for years 2014 to 2018 in Table 13 of SEDAR 68-DW-09.

4.7.4 SRHS Effort

Effort data from the SRHS is provided as the number of anglers on a given trip, which is standardized to “angler days” based on the length of the trip (e.g., 40 anglers on a half-day trip would yield $40 * 0.5 = 20$ angler days). Angler days are summed by month for individual vessels. Each month, port agents collect these logbook trip reports and check for accuracy and completeness. Although reporting via the logbooks is mandatory, compliance is not 100% and is variable by location. To account for non-reporting, a correction factor is developed based on sampler observations, angler numbers from office books, and any available information. This information is used to provide estimates of total catch by month and area, along with estimates of effort.

In order to summarize recreational fishing effort across the Gulf of Mexico, SRHS effort estimates are also provided in units of angler trips to match that provided by the MRIP, TPWD, and LA Creel surveys. Monthly estimates of angler trips are calculated as the product of the reported number of anglers and ratios for the estimated number of total trips to the reported number of total trips (SEDAR 28-DW-12).

SRHS effort estimates (in angler days) are provided in Table 4.12.9. Estimated headboat angler days have increased in the Gulf of Mexico in recent years, following a decrease in effort which began with high fuel prices in both the South Atlantic and Gulf of Mexico in the 2000s (Table 4.12.9). This coupled with the economic downturn starting in 2008 and the Deepwater Horizon oil spill in 2010 resulted in a marked decline in angler days in the Gulf of Mexico headboat fishery. Reports from industry staff, captains/owners, and port agents indicated fuel prices, the economy and fishing regulations are the factors that most affected the number of trips, number of passengers, and overall fishing effort.

4.7.5 Total Recreational Fishing Effort

Combined effort estimates in angler trips (MRIP, SRHS, TPWD, and LA Creel) are shown by year and mode in Table 4.12.10, Figure 4.13.8, and mapped in Figure 4.13.9. These effort estimates depict all recreational fishing activity in the Gulf of Mexico and are not specific to Scamp. The vast majority (about 95%) of the general recreational fishing effort in the Gulf of Mexico comes from the private mode. Geographically, the majority of the fishing effort comes from West Florida, not including the Florida Keys (about 65%), followed by Louisiana (about 20%). Effort estimates have steadily increased until about the early-2010s, after which effort declined and has remained low. It is worth noting that the Louisiana effort estimates since 2014 have been collected under a different survey methodology.

4.8 COMMENTS ON ADEQUACY OF DATA FOR ASSESSMENT ANALYSES

Task 10: Regarding the adequacy of the available recreational data for assessment analyses, the recreational working group discussed the following:

- Catch estimates (landings and discards) appear to be adequate for the time period covered (1955-2018)
- Size data appear to adequately represent the landed catch for all modes
- Discard size data from the headboat and charter boat fleets appear to be regulatory discards
- Uncertainty for total recreational landing estimates are considered adequate for use in this assessment.

4.9 Itemized List of Tasks for Completion following Workshop

- Weighted length and age compositions will be completed for the Assessment Workshop

4.10 RESEARCH RECOMMENDATIONS

4.10.1 Research Recommendations for SEDAR 68

Task 11:

- Continue to develop methods to provide uncertainty estimates around landings and discard estimates
- Increase sampling of the recreational fishing fleet, particularly the charter boat and private angler sector, to improve discard data collection. Discard length data and discard mortality are two areas of importance that should be included.
- Investigate the implications of the MRIP imputed lengths and weighting factors for a range of data-rich to data-limited species, where the length frequency distributions become erratic

4.11 Literature Cited

Brennan, K. 2020. SEDAR 68-DW-12. Estimates of Historic Recreational Landings of Scamp and Yellowmouth Grouper in the Gulf of Mexico Using the FHWAR Census Method. National Marine Fisheries Service (NMFS) Southeast Fisheries Science Center (SEFSC) Beaufort Laboratory. Beaufort, NC.

Dettloff, K and V Matter. 2019. SEDAR 64-RD-12. Model-estimated conversion factors for calibrating Coastal Household Telephone Survey (CHTS) charter boat catch and effort estimates with For-hire Survey (FHS) estimates in the Atlantic and Gulf of Mexico with application to red grouper and greater amberjack. National Marine Fisheries Service (NMFS) Southeast Fisheries Science Center (SEFSC) Fisheries Statistics Division. Miami, FL.

Dettloff, K and V Matter. 2019. SEDAR 67-WP-06. Sample Size Sensitivity Analysis for calculating MRIP Weight Estimates. National Marine Fisheries Service (NMFS) Southeast Fisheries Science Center (SEFSC) Fisheries Statistics Division. Miami, FL.

- Dettloff, K, V Matter, and M Nuttall. 2020. SEDAR 68-DW-10. SEFSC Computation of Variance Estimates for Custom Data Aggregations from the Marine Recreational Information Program. National Marine Fisheries Service (NMFS) Southeast Fisheries Science Center (SEFSC) Fisheries Statistics Division. Miami, FL.
- Fisheries Ecosystems Branch. 2020. SEDAR68-DW-33. Discards of scamp (*Mycteroperca phenax*) for the headboat fishery in the US Gulf of Mexico. National Marine Fisheries Service (NMFS), Southeast Fisheries Science Center (SEFSC), Beaufort, NC.
- Lazarre, D. 2020. SEDAR68-DW-24. A Summary of Observer Data from the Size Distribution and Release Condition of Scamp Discards from Recreational Fishery Surveys in the Eastern Gulf of Mexico. Florida Fish and Wildlife Conservation Commission (FWC), Fish and Wildlife Research Institute (FWRI) Saint Petersburg, FL.
- Matter, VM and A Rios. 2013. SEDAR 32-DW-02. MRFSS to MRIP Adjustment Ratios and Weight Estimation Procedures for South Atlantic and Gulf of Mexico Managed Species. National Marine Fisheries Service (NMFS) Southeast Fisheries Science Center (SEFSC) Fisheries Statistics Division. Miami, FL.
- Matter, V, N Cummings, J Isely, K Brennan, and K Fitzpatrick. 2012. SEDAR 28-DW-12. Estimated conversion factors for calibrating MRFSS charter boat landings and effort estimates for the South Atlantic and Gulf of Mexico in 1981-1985 with For-hire Survey estimates with application to Spanish mackerel and cobia landings. National Marine Fisheries Service (NMFS) Southeast Fisheries Science Center (SEFSC) Fisheries Statistics Division. Miami, FL.
- Matter, V and M Nuttall. 2020. SEDAR 68-WP-09. Recreational Survey Data for Scamp and Yellowmouth Grouper in the Gulf of Mexico. National Marine Fisheries Service (NMFS) Southeast Fisheries Science Center (SEFSC) Fisheries Statistics Division. Miami, FL.
- Matter, V and M Nuttall. 2020. SEDAR 68-DW-13. Marine Recreational Information Program: Metadata for the Atlantic, Gulf of Mexico, and Caribbean Regions. National Marine Fisheries Service (NMFS) Southeast Fisheries Science Center (SEFSC) Fisheries Statistics Division. Miami, FL.

Nuttall, M, K Dettloff, K Fitzpatrick, K Brennan, and V Matter. 2020. SEDAR 68-DW-31. SEFSC Computation of Uncertainty for Southeast Regional Headboat Survey and Total Recreational Landings Estimates. National Marine Fisheries Service (NMFS) Southeast Fisheries Science Center (SEFSC) Fisheries Statistics Division. Miami, FL.

Nuttall, M and V Matter. 2020. SEDAR 70-WP-03. Texas Parks and Wildlife Department's Marine Sport-Harvest Monitoring Program Metadata. National Marine Fisheries Service (NMFS) Southeast Fisheries Science Center (SEFSC) Fisheries Statistics Division. Miami, FL.

SEDAR Procedural Workshop 7. 2015. SEDAR-PW-07. Data Best Practices. SEDAR, North Charleston, SC.

SEDAR 68 Stock ID Panel. 2020. Gulf of Mexico and Atlantic Scamp Stock ID Process Final Report. SEDAR68-SID-05. SEDAR, North Charleston, SC.

4.12 TABLES

Table 4.12.1. Estimated SRHS headboat landings of Gulf of Mexico Scamp and Yellowmouth Grouper. Landings are provided in number of fish and pounds whole weight; CVs are not available in weight units. Due to headboat area definitions and confidentiality issues, estimates of SRHS catch are combined for: (i) Texas, Louisiana, and Mississippi and (ii) Alabama and western Florida.

| Year | Number | | | | Pounds | | |
|------|----------|--------|-------|-------|----------|--------|--------|
| | TX/LA/MS | FLW/AL | Total | CV | TX/LA/MS | FLW/AL | Total |
| 1981 | 871 | | 871 | | 3,285 | | 3,285 |
| 1982 | 871 | | 871 | | 3,285 | | 3,285 |
| 1983 | 871 | | 871 | | 3,285 | | 3,285 |
| 1984 | 871 | | 871 | | 3,285 | | 3,285 |
| 1985 | 871 | | 871 | | 3,285 | | 3,285 |
| 1986 | 1,397 | 5,866 | 7,263 | 0.058 | 3,942 | 14,053 | 17,995 |
| 1987 | 797 | 3,780 | 4,577 | 0.046 | 5,139 | 6,559 | 11,698 |
| 1988 | 1,121 | 2,278 | 3,399 | 0.049 | 4,150 | 4,395 | 8,545 |
| 1989 | 467 | 8,843 | 9,310 | 0.030 | 1,159 | 23,016 | 24,175 |
| 1990 | 677 | 1,711 | 2,388 | 0.033 | 2,339 | 4,594 | 6,933 |
| 1991 | 922 | 1,134 | 2,056 | 0.019 | 3,199 | 4,313 | 7,512 |
| 1992 | 709 | 902 | 1,611 | 0.011 | 1,529 | 2,679 | 4,208 |
| 1993 | 438 | 1,247 | 1,685 | 0.006 | 1,247 | 2,876 | 4,123 |
| 1994 | 356 | 781 | 1,137 | 0.040 | 1,445 | 1,493 | 2,938 |
| 1995 | 644 | 726 | 1,370 | 0.102 | 2,167 | 1,548 | 3,715 |
| 1996 | 479 | 334 | 813 | 0.069 | 1,811 | 674 | 2,484 |
| 1997 | 531 | 634 | 1,165 | 0.041 | 1,658 | 1,192 | 2,850 |
| 1998 | 456 | 785 | 1,241 | 0.026 | 2,589 | 2,474 | 5,063 |
| 1999 | 301 | 763 | 1,064 | 0.021 | 1,055 | 1,678 | 2,733 |
| 2000 | 281 | 747 | 1,028 | 0.030 | 1,530 | 2,876 | 4,406 |
| 2001 | 337 | 279 | 616 | 0.032 | 1,110 | 665 | 1,775 |
| 2002 | 388 | 317 | 705 | 0.046 | 1,281 | 542 | 1,823 |
| 2003 | 246 | 429 | 675 | 0.026 | 1,067 | 801 | 1,867 |
| 2004 | 307 | 1,008 | 1,315 | 0.063 | 754 | 2,254 | 3,007 |
| 2005 | 307 | 768 | 1,075 | 0.018 | 868 | 1,365 | 2,233 |
| 2006 | 273 | 316 | 589 | 0.040 | 1,983 | 594 | 2,576 |
| 2007 | 169 | 499 | 668 | 0.042 | 688 | 1,668 | 2,356 |
| 2008 | 173 | 435 | 608 | 0.016 | 1,019 | 1,049 | 2,068 |
| 2009 | 220 | 378 | 598 | 0.005 | 543 | 877 | 1,420 |
| 2010 | 451 | 541 | 992 | 0.005 | 2,802 | 1,089 | 3,891 |
| 2011 | 312 | 503 | 815 | 0.000 | 1,675 | 2,722 | 4,396 |
| 2012 | 204 | 892 | 1,096 | 0.000 | 1,397 | 2,239 | 3,636 |
| 2013 | 231 | 1,157 | 1,388 | 0.001 | 1,627 | 2,834 | 4,461 |
| 2014 | 377 | 1,723 | 2,100 | 0.000 | 2,709 | 4,253 | 6,962 |
| 2015 | 389 | 2,224 | 2,613 | 0.000 | 2,867 | 6,376 | 9,242 |
| 2016 | 486 | 1,244 | 1,730 | 0.000 | 2,952 | 2,818 | 5,769 |
| 2017 | 499 | 1,038 | 1,537 | 0.000 | 2,302 | 2,023 | 4,325 |
| 2018 | 651 | 1,215 | 1,866 | 0.000 | 4,629 | 3,089 | 7,718 |

Table 4.12.2. Estimated historical recreational landings for Scamp and Yellowmouth Grouper in the Gulf of Mexico 1955-1980 (CV=0.67).

| Year | Number |
|-------------|---------------|
| 1955 | 18,673 |
| 1956 | 20,667 |
| 1957 | 22,661 |
| 1958 | 24,655 |
| 1959 | 26,649 |
| 1960 | 28,642 |
| 1961 | 29,599 |
| 1962 | 30,555 |
| 1963 | 31,511 |
| 1964 | 32,467 |
| 1965 | 33,423 |
| 1966 | 34,447 |
| 1967 | 35,470 |
| 1968 | 36,494 |
| 1969 | 37,518 |
| 1970 | 38,541 |
| 1971 | 42,117 |
| 1972 | 45,693 |
| 1973 | 49,268 |
| 1974 | 52,844 |
| 1975 | 56,420 |
| 1976 | 56,648 |
| 1977 | 56,877 |
| 1978 | 57,105 |
| 1979 | 57,334 |
| 1980 | 57,563 |

Table 4.12.3. Total recreational landings estimates (AB1) for Gulf of Mexico Scamp and Yellowmouth Grouper combined across all surveys (MRIP, SRHS, TPWD, and LA Creel) by year and mode in numbers of fish. The associated coefficients of variation (CV) are provided for total recreational catch (in numbers). Annual landings are also provided in pounds whole weight (lbs); CVs are not available in weight units.

| Year | Hbt | Cbt | Priv | Total | CV | lbs |
|------|--------|--------|--------|---------|------|---------|
| 1981 | 7,211 | 10,137 | 37,194 | 54,542 | 0.50 | 103,469 |
| 1982 | 9,222 | 13,353 | 80,044 | 102,620 | 0.34 | 228,909 |
| 1983 | 13,650 | 20,432 | 16,305 | 50,387 | 0.52 | 205,864 |
| 1984 | 4,478 | 5,768 | 0 | 10,246 | 0.46 | 35,583 |
| 1985 | 4,433 | 5,714 | 11,386 | 21,533 | 0.63 | 76,658 |
| 1986 | 7,263 | 22,873 | 24,902 | 55,038 | 0.28 | 221,874 |
| 1987 | 4,577 | 10,150 | 58,366 | 73,093 | 0.60 | 290,968 |
| 1988 | 3,399 | 11,175 | 28,352 | 42,926 | 0.26 | 153,563 |
| 1989 | 9,310 | 12,590 | 6,021 | 27,921 | 0.25 | 110,112 |
| 1990 | 2,388 | 6,450 | 74 | 8,912 | 0.65 | 30,565 |
| 1991 | 2,056 | 5,170 | 9,703 | 16,929 | 0.63 | 55,704 |
| 1992 | 1,611 | 10,118 | 3,534 | 15,262 | 0.33 | 64,930 |
| 1993 | 1,685 | 14,397 | 9,036 | 25,119 | 0.40 | 132,689 |
| 1994 | 1,137 | 12,769 | 99 | 14,005 | 0.53 | 56,008 |
| 1995 | 1,370 | 4,296 | 34 | 5,700 | 0.49 | 19,432 |
| 1996 | 813 | 12,281 | 32 | 13,126 | 0.55 | 47,088 |
| 1997 | 1,165 | 10,200 | 4,519 | 15,885 | 0.33 | 107,305 |
| 1998 | 1,241 | 20,104 | 629 | 21,974 | 0.20 | 140,080 |
| 1999 | 1,064 | 26,794 | 12,935 | 40,794 | 0.27 | 161,466 |
| 2000 | 1,028 | 5,297 | 5,265 | 11,591 | 0.34 | 48,313 |
| 2001 | 616 | 10,311 | 3,263 | 14,190 | 0.20 | 66,219 |
| 2002 | 705 | 10,832 | 13,631 | 25,168 | 0.27 | 94,570 |
| 2003 | 675 | 11,725 | 33,667 | 46,067 | 0.50 | 159,813 |
| 2004 | 1,315 | 31,443 | 20,665 | 53,423 | 0.25 | 140,523 |
| 2005 | 1,075 | 17,904 | 43,379 | 62,358 | 0.47 | 172,859 |
| 2006 | 589 | 17,974 | 87,416 | 105,979 | 0.77 | 326,910 |
| 2007 | 668 | 11,912 | 28,549 | 41,129 | 0.30 | 104,987 |
| 2008 | 608 | 9,168 | 50,681 | 60,457 | 0.46 | 250,828 |
| 2009 | 598 | 12,582 | 36,665 | 49,845 | 0.55 | 203,628 |
| 2010 | 992 | 6,260 | 21,147 | 28,399 | 0.45 | 93,336 |
| 2011 | 815 | 14,872 | 29,077 | 44,764 | 0.26 | 114,936 |
| 2012 | 1,096 | 11,210 | 64,982 | 77,288 | 0.34 | 235,918 |
| 2013 | 1,388 | 14,262 | 62,888 | 78,538 | 0.25 | 270,883 |
| 2014 | 2,100 | 18,497 | 57,838 | 78,436 | 0.28 | 274,026 |
| 2015 | 2,613 | 13,668 | 92,326 | 108,607 | 0.52 | 355,556 |
| 2016 | 1,730 | 24,430 | 44,122 | 70,282 | 0.32 | 255,152 |
| 2017 | 1,537 | 14,916 | 31,528 | 47,981 | 0.41 | 199,274 |
| 2018 | 1,866 | 7,121 | 47,118 | 56,105 | 0.33 | 239,033 |

Table 4.12.4. Estimated SRHS headboat discards of Gulf of Mexico Scamp and Yellowmouth Grouper. Discards are provided in number of fish. Due to headboat area definitions and confidentiality issues, estimates of SRHS catch are combined for: (i) Texas, Louisiana, and Mississippi and (ii) Alabama and western Florida.

| Year | TX/LA/MS | FLW/AL | Total |
|------|----------|--------|-------|
| 1986 | 0 | 0 | 0 |
| 1987 | 0 | 0 | 0 |
| 1988 | 0 | 0 | 0 |
| 1989 | 0 | 0 | 0 |
| 1990 | 0 | 0 | 0 |
| 1991 | 0 | 0 | 0 |
| 1992 | 0 | 0 | 0 |
| 1993 | 0 | 0 | 0 |
| 1994 | 0 | 0 | 0 |
| 1995 | 0 | 0 | 0 |
| 1996 | 0 | 0 | 0 |
| 1997 | 0 | 0 | 0 |
| 1998 | 0 | 0 | 0 |
| 1999 | 0 | 0 | 0 |
| 2000 | 0 | 1,811 | 1,811 |
| 2001 | 0 | 676 | 676 |
| 2002 | 0 | 768 | 768 |
| 2003 | 0 | 1,040 | 1,040 |
| 2004 | 1 | 1,609 | 1,610 |
| 2005 | 0 | 685 | 685 |
| 2006 | 42 | 427 | 469 |
| 2007 | 14 | 657 | 671 |
| 2008 | 24 | 2,775 | 2,799 |
| 2009 | 6 | 2,676 | 2,682 |
| 2010 | 3 | 1,757 | 1,760 |
| 2011 | 88 | 1,848 | 1,936 |
| 2012 | 5 | 1,904 | 1,909 |
| 2013 | 17 | 1,878 | 1,895 |
| 2014 | 17 | 2,953 | 2,970 |
| 2015 | 0 | 3,500 | 3,500 |
| 2016 | 6 | 1,874 | 1,880 |
| 2017 | 0 | 1,689 | 1,689 |
| 2018 | 3 | 2,173 | 2,176 |

Table 4.12.5. Total recreational discard estimates (B2) for Gulf of Mexico Scamp and Yellowmouth Grouper combined across all surveys (MRIP, SRHS, TPWD, and LA Creel) by year and mode in numbers of fish. The associated coefficients of variation (CV) are provided for total recreational discards (in numbers).

| Year | Hbt | Cbt | Priv | Total | CV |
|------|-------|--------|---------|---------|------|
| 1981 | 0 | 0 | 0 | 0 | 0.00 |
| 1982 | 0 | 1,411 | 50,137 | 51,548 | 0.43 |
| 1983 | 0 | 1,089 | 0 | 1,089 | 0.62 |
| 1984 | 0 | 1,389 | 0 | 1,389 | 0.63 |
| 1985 | 0 | 7,453 | 0 | 7,453 | 0.66 |
| 1986 | 0 | 30,041 | 24,077 | 54,118 | 0.67 |
| 1987 | 0 | 605 | 823 | 1,428 | 0.72 |
| 1988 | 0 | 323 | 3,378 | 3,701 | 0.92 |
| 1989 | 0 | 1,858 | 0 | 1,858 | 0.68 |
| 1990 | 0 | 4,395 | 36,301 | 40,696 | 0.66 |
| 1991 | 0 | 0 | 3,128 | 3,128 | 1.00 |
| 1992 | 0 | 4,443 | 27,406 | 31,849 | 0.54 |
| 1993 | 0 | 2,723 | 37,345 | 40,068 | 0.52 |
| 1994 | 0 | 2,007 | 10,786 | 12,792 | 0.71 |
| 1995 | 0 | 1,922 | 2,859 | 4,780 | 0.63 |
| 1996 | 0 | 114 | 816 | 930 | 0.88 |
| 1997 | 0 | 3,554 | 3,471 | 7,025 | 0.63 |
| 1998 | 0 | 1,661 | 2,884 | 4,545 | 0.51 |
| 1999 | 0 | 661 | 8,983 | 9,645 | 0.57 |
| 2000 | 1,811 | 2,153 | 61,616 | 65,579 | 0.87 |
| 2001 | 676 | 3,792 | 51,082 | 55,550 | 0.74 |
| 2002 | 768 | 8,637 | 11,268 | 20,673 | 0.36 |
| 2003 | 1,040 | 5,886 | 164,133 | 171,059 | 0.42 |
| 2004 | 1,610 | 20,433 | 156,051 | 178,094 | 0.33 |
| 2005 | 685 | 6,051 | 20,881 | 27,617 | 0.33 |
| 2006 | 469 | 1,650 | 17,476 | 19,596 | 0.48 |
| 2007 | 671 | 6,408 | 82,688 | 89,767 | 0.33 |
| 2008 | 2,799 | 9,896 | 104,783 | 117,478 | 0.37 |
| 2009 | 2,682 | 5,081 | 138,261 | 146,024 | 0.50 |
| 2010 | 1,760 | 7,153 | 224,917 | 233,830 | 0.40 |
| 2011 | 1,936 | 1,698 | 29,744 | 33,378 | 0.46 |
| 2012 | 1,909 | 1,370 | 183,013 | 186,292 | 0.68 |
| 2013 | 1,895 | 3,009 | 25,356 | 30,260 | 0.53 |
| 2014 | 2,970 | 5,941 | 119,954 | 128,865 | 0.32 |
| 2015 | 3,500 | 5,988 | 178,674 | 188,162 | 0.53 |
| 2016 | 1,880 | 17,399 | 41,688 | 60,967 | 0.36 |
| 2017 | 1,689 | 5,222 | 71,870 | 78,780 | 0.67 |
| 2018 | 2,176 | 2,181 | 8,669 | 13,026 | 0.76 |

Table 4.12.6. Summary of weight measurements (pounds whole weight) from MRIP-intercepted Scamp and Yellowmouth Grouper by state and year. Summaries include the number of fish weighed by MRIP (Fish), the number of angler trips from which those fish were weighed (Trp), and the minimum (Min), geometric mean (Avg), and maximum (Max) size of fish weights. MRIP catch estimates for western Florida exclude the Florida Keys. LA weights are available from MRIP only until 2013.

| Year | LA | | | | | MS | | | | | AL | | | | | FLW | | | | |
|------|------|-----|-----|------|------|------|-----|-----|-----|-----|------|-----|-----|------|------|------|-----|-----|-----|------|
| | Fish | Trp | Min | Avg | Max | Fish | Trp | Min | Avg | Max | Fish | Trp | Min | Avg | Max | Fish | Trp | Min | Avg | Max |
| 1981 | 0 | 0 | 0.0 | 0.0 | 0.0 | 0 | 0 | 0.0 | 0.0 | 0.0 | 1 | 1 | 6.6 | 6.6 | 6.6 | 49 | 21 | 0.9 | 1.9 | 11.5 |
| 1982 | 0 | 0 | 0.0 | 0.0 | 0.0 | 25 | 4 | 1.0 | 1.3 | 2.2 | 9 | 4 | 0.9 | 1.7 | 5.5 | 18 | 16 | 0.7 | 3.0 | 10.4 |
| 1983 | 0 | 0 | 0.0 | 0.0 | 0.0 | 0 | 0 | 0.0 | 0.0 | 0.0 | 1 | 1 | 4.9 | 4.9 | 4.9 | 28 | 21 | 0.9 | 4.3 | 10.9 |
| 1984 | 0 | 0 | 0.0 | 0.0 | 0.0 | 0 | 0 | 0.0 | 0.0 | 0.0 | 0 | 0 | 0.0 | 0.0 | 0.0 | 16 | 8 | 1.1 | 2.8 | 6.3 |
| 1985 | 0 | 0 | 0.0 | 0.0 | 0.0 | 0 | 0 | 0.0 | 0.0 | 0.0 | 0 | 0 | 0.0 | 0.0 | 0.0 | 11 | 11 | 0.9 | 4.9 | 8.9 |
| 1986 | 0 | 0 | 0.0 | 0.0 | 0.0 | 0 | 0 | 0.0 | 0.0 | 0.0 | 0 | 0 | 0.0 | 0.0 | 0.0 | 78 | 45 | 0.5 | 3.9 | 8.1 |
| 1987 | 2 | 1 | 0.4 | 0.8 | 1.1 | 0 | 0 | 0.0 | 0.0 | 0.0 | 0 | 0 | 0.0 | 0.0 | 0.0 | 35 | 23 | 0.7 | 3.7 | 11.5 |
| 1988 | 0 | 0 | 0.0 | 0.0 | 0.0 | 0 | 0 | 0.0 | 0.0 | 0.0 | 0 | 3 | 0.0 | 0.0 | 0.0 | 15 | 20 | 0.6 | 2.5 | 5.4 |
| 1989 | 0 | 0 | 0.0 | 0.0 | 0.0 | 0 | 0 | 0.0 | 0.0 | 0.0 | 1 | 2 | 2.0 | 2.0 | 2.0 | 23 | 11 | 0.7 | 4.3 | 8.2 |
| 1990 | 0 | 0 | 0.0 | 0.0 | 0.0 | 0 | 0 | 0.0 | 0.0 | 0.0 | 0 | 0 | 0.0 | 0.0 | 0.0 | 4 | 3 | 1.3 | 3.4 | 5.9 |
| 1991 | 5 | 2 | 1.6 | 2.2 | 2.9 | 0 | 0 | 0.0 | 0.0 | 0.0 | 1 | 1 | 7.6 | 7.6 | 7.6 | 11 | 6 | 1.3 | 3.3 | 7.9 |
| 1992 | 4 | 4 | 2.4 | 3.1 | 3.4 | 0 | 0 | 0.0 | 0.0 | 0.0 | 12 | 6 | 2.1 | 5.0 | 9.2 | 21 | 10 | 1.9 | 4.6 | 11.4 |
| 1993 | 1 | 1 | 2.8 | 2.8 | 2.8 | 0 | 0 | 0.0 | 0.0 | 0.0 | 3 | 2 | 3.7 | 5.7 | 8.0 | 46 | 11 | 1.2 | 4.9 | 17.1 |
| 1994 | 0 | 0 | 0.0 | 0.0 | 0.0 | 0 | 0 | 0.0 | 0.0 | 0.0 | 1 | 1 | 2.3 | 2.3 | 2.3 | 21 | 9 | 1.1 | 4.1 | 10.3 |
| 1995 | 1 | 1 | 4.4 | 4.4 | 4.4 | 0 | 0 | 0.0 | 0.0 | 0.0 | 1 | 1 | 4.3 | 4.3 | 4.3 | 2 | 2 | 1.2 | 2.5 | 3.9 |
| 1996 | 0 | 0 | 0.0 | 0.0 | 0.0 | 0 | 0 | 0.0 | 0.0 | 0.0 | 1 | 1 | 2.2 | 2.2 | 2.2 | 5 | 3 | 3.7 | 5.7 | 9.0 |
| 1997 | 3 | 2 | 9.5 | 10.7 | 12.9 | 0 | 0 | 0.0 | 0.0 | 0.0 | 1 | 1 | 8.3 | 8.3 | 8.3 | 76 | 27 | 2.0 | 6.9 | 16.6 |
| 1998 | 0 | 0 | 0.0 | 0.0 | 0.0 | 0 | 0 | 0.0 | 0.0 | 0.0 | 7 | 5 | 0.7 | 5.5 | 12.1 | 159 | 65 | 1.1 | 6.1 | 17.1 |
| 1999 | 6 | 5 | 2.3 | 7.0 | 16.0 | 0 | 0 | 0.0 | 0.0 | 0.0 | 6 | 3 | 3.6 | 16.0 | 28.5 | 299 | 86 | 0.8 | 3.8 | 15.5 |
| 2000 | 4 | 3 | 1.6 | 14.7 | 28.6 | 0 | 0 | 0.0 | 0.0 | 0.0 | 4 | 4 | 1.4 | 2.7 | 5.7 | 125 | 68 | 0.6 | 4.0 | 16.2 |
| 2001 | 3 | 3 | 1.7 | 8.8 | 19.1 | 0 | 0 | 0.0 | 0.0 | 0.0 | 9 | 6 | 1.4 | 4.3 | 10.0 | 269 | 77 | 1.1 | 4.6 | 18.1 |
| 2002 | 9 | 6 | 2.5 | 5.8 | 10.5 | 0 | 0 | 0.0 | 0.0 | 0.0 | 14 | 10 | 0.9 | 4.1 | 18.7 | 310 | 114 | 0.8 | 3.7 | 15.3 |
| 2003 | 0 | 0 | 0.0 | 0.0 | 0.0 | 0 | 0 | 0.0 | 0.0 | 0.0 | 13 | 12 | 1.4 | 3.1 | 4.7 | 379 | 125 | 0.8 | 3.5 | 17.4 |
| 2004 | 4 | 3 | 1.8 | 2.3 | 3.3 | 0 | 0 | 0.0 | 0.0 | 0.0 | 69 | 22 | 1.0 | 3.5 | 16.6 | 645 | 255 | 1.0 | 2.9 | 18.5 |
| 2005 | 13 | 5 | 1.9 | 3.9 | 10.1 | 0 | 0 | 0.0 | 0.0 | 0.0 | 47 | 27 | 1.3 | 2.5 | 16.9 | 460 | 182 | 1.0 | 3.0 | 18.6 |
| 2006 | 33 | 12 | 1.2 | 5.6 | 17.1 | 0 | 0 | 0.0 | 0.0 | 0.0 | 40 | 15 | 1.1 | 2.6 | 7.7 | 299 | 119 | 1.2 | 3.0 | 19.5 |
| 2007 | 3 | 3 | 1.7 | 1.8 | 2.1 | 0 | 0 | 0.0 | 0.0 | 0.0 | 28 | 13 | 1.2 | 3.2 | 5.5 | 241 | 114 | 1.4 | 3.0 | 16.3 |
| 2008 | 7 | 3 | 1.8 | 3.3 | 4.2 | 0 | 0 | 0.0 | 0.0 | 0.0 | 11 | 5 | 1.4 | 2.9 | 6.0 | 165 | 72 | 1.3 | 3.6 | 11.7 |
| 2009 | 1 | 1 | 3.6 | 3.6 | 3.6 | 0 | 0 | 0.0 | 0.0 | 0.0 | 1 | 1 | 1.7 | 1.7 | 1.7 | 127 | 50 | 1.5 | 4.2 | 13.4 |

| Year | LA | | | | | MS | | | | | AL | | | | | FLW | | | | |
|------|------|-----|-----|-----|------|------|-----|-----|-----|------|------|-----|-----|-----|------|------|-----|-----|-----|------|
| | Fish | Trp | Min | Avg | Max | Fish | Trp | Min | Avg | Max | Fish | Trp | Min | Avg | Max | Fish | Trp | Min | Avg | Max |
| 2010 | 7 | 2 | 1.8 | 5.2 | 12.9 | 0 | 0 | 0.0 | 0.0 | 0.0 | 7 | 7 | 1.3 | 2.2 | 4.5 | 101 | 56 | 1.2 | 3.3 | 13.5 |
| 2011 | 9 | 1 | 3.5 | 4.0 | 5.1 | 0 | 0 | 0.0 | 0.0 | 0.0 | 27 | 14 | 1.7 | 2.5 | 4.4 | 373 | 131 | 1.2 | 2.6 | 9.5 |
| 2012 | 25 | 7 | 2.5 | 5.3 | 11.7 | 0 | 0 | 0.0 | 0.0 | 0.0 | 5 | 5 | 2.0 | 3.2 | 4.9 | 185 | 91 | 1.4 | 3.1 | 12.0 |
| 2013 | 9 | 4 | 2.3 | 6.7 | 16.5 | 5 | 1 | 5.2 | 8.3 | 14.4 | 28 | 14 | 1.6 | 3.6 | 8.3 | 87 | 31 | 1.4 | 3.4 | 10.2 |
| 2014 | | | | | | 0 | 0 | 0.0 | 0.0 | 0.0 | 25 | 13 | 1.4 | 4.1 | 14.0 | 123 | 53 | 1.1 | 3.3 | 10.7 |
| 2015 | | | | | | 0 | 0 | 0.0 | 0.0 | 0.0 | 36 | 15 | 1.4 | 4.2 | 11.0 | 128 | 61 | 1.5 | 3.2 | 12.5 |
| 2016 | | | | | | 0 | 0 | 0.0 | 0.0 | 0.0 | 20 | 7 | 0.9 | 4.0 | 7.2 | 145 | 52 | 1.3 | 4.3 | 12.3 |
| 2017 | | | | | | 0 | 0 | 0.0 | 0.0 | 0.0 | 24 | 10 | 1.8 | 5.0 | 8.8 | 41 | 23 | 1.5 | 4.2 | 10.8 |
| 2018 | | | | | | 1 | 1 | 3.1 | 3.1 | 3.1 | 43 | 10 | 2.2 | 4.2 | 8.3 | 27 | 14 | 1.5 | 4.4 | 10.8 |

Table 4.12.7. Summary of weight measurements (kilograms whole weight) from SRHS-intercepted Scamp and Yellowmouth Grouper by state and year. Summaries include the number of fish weighed by SRHS (Fish), the number of angler trips from which those fish were weighed (Trips), and the geometric mean (Mean), minimum (Min), and maximum (Max) size of fish weights.

| YEAR | TX/LA/MS | | | | | FLW/AL | | | | | Gulf of Mexico | | | | |
|------|----------|-----------|-----------|----------|----------|----------|-----------|-----------|----------|----------|----------------|-----------|-----------|----------|----------|
| | Fish (n) | Trips (n) | Mean (kg) | Min (kg) | Max (kg) | Fish (n) | Trips (n) | Mean (kg) | Min (kg) | Max (kg) | Fish (n) | Trips (n) | Mean (kg) | Min (kg) | Max (kg) |
| 1986 | 79 | 60 | 1.25 | 0.23 | 5.80 | 98 | 67 | 1.42 | 0.23 | 6.30 | 177 | 127 | 1.34 | 0.23 | 6.05 |
| 1987 | 49 | 35 | 1.97 | 0.21 | 18.60 | 98 | 67 | 1.32 | 0.30 | 4.92 | 147 | 102 | 1.65 | 0.25 | 11.76 |
| 1988 | 16 | 16 | 1.51 | 0.26 | 4.41 | 72 | 60 | 1.10 | 0.21 | 4.48 | 88 | 76 | 1.31 | 0.24 | 4.45 |
| 1989 | 19 | 17 | 1.21 | 0.40 | 7.46 | 185 | 84 | 1.08 | 0.28 | 9.90 | 204 | 101 | 1.14 | 0.34 | 8.68 |
| 1990 | 24 | 17 | 1.46 | 0.32 | 4.73 | 99 | 38 | 1.29 | 0.27 | 7.36 | 123 | 55 | 1.38 | 0.30 | 6.05 |
| 1991 | 6 | 5 | 0.49 | 0.41 | 0.57 | 43 | 21 | 1.58 | 0.28 | 4.52 | 49 | 26 | 1.03 | 0.35 | 2.55 |
| 1992 | 27 | 21 | 0.90 | 0.41 | 2.87 | 36 | 24 | 1.29 | 0.26 | 4.39 | 63 | 45 | 1.09 | 0.34 | 3.63 |
| 1993 | 10 | 9 | 1.37 | 0.61 | 3.18 | 38 | 24 | 0.99 | 0.42 | 4.82 | 48 | 33 | 1.18 | 0.52 | 4.00 |
| 1994 | 33 | 23 | 1.56 | 0.52 | 3.58 | 44 | 33 | 0.83 | 0.36 | 4.35 | 77 | 56 | 1.20 | 0.44 | 3.97 |
| 1995 | 28 | 21 | 1.56 | 0.43 | 4.12 | 40 | 30 | 1.11 | 0.35 | 5.27 | 68 | 51 | 1.33 | 0.39 | 4.70 |
| 1996 | 13 | 11 | 2.60 | 0.50 | 9.90 | 40 | 26 | 0.93 | 0.45 | 2.71 | 53 | 37 | 1.76 | 0.48 | 6.31 |
| 1997 | 12 | 10 | 1.25 | 0.36 | 5.19 | 19 | 15 | 0.86 | 0.38 | 3.98 | 31 | 25 | 1.06 | 0.37 | 4.59 |
| 1998 | 12 | 11 | 3.34 | 0.77 | 8.78 | 25 | 17 | 1.25 | 0.60 | 4.14 | 37 | 28 | 2.30 | 0.69 | 6.46 |
| 1999 | 12 | 10 | 1.66 | 0.47 | 4.58 | 26 | 19 | 0.94 | 0.35 | 1.97 | 38 | 29 | 1.30 | 0.41 | 3.28 |
| 2000 | 2 | 2 | 2.14 | 1.08 | 3.19 | 33 | 22 | 1.78 | 0.50 | 7.77 | 35 | 24 | 1.96 | 0.79 | 5.48 |
| 2001 | 6 | 6 | 2.18 | 0.68 | 3.82 | 21 | 17 | 1.12 | 0.55 | 2.04 | 27 | 23 | 1.65 | 0.62 | 2.93 |
| 2002 | 4 | 4 | 1.33 | 0.58 | 2.07 | 40 | 18 | 0.99 | 0.49 | 8.14 | 44 | 22 | 1.16 | 0.54 | 5.11 |
| 2003 | 11 | 7 | 1.97 | 0.63 | 4.69 | 154 | 50 | 0.88 | 0.19 | 7.58 | 165 | 57 | 1.42 | 0.41 | 6.14 |
| 2004 | 5 | 5 | 0.88 | 0.49 | 1.28 | 41 | 31 | 1.03 | 0.63 | 6.81 | 46 | 36 | 0.96 | 0.56 | 4.05 |
| 2005 | 6 | 6 | 2.12 | 0.84 | 3.94 | 22 | 13 | 0.80 | 0.59 | 1.33 | 28 | 19 | 1.46 | 0.72 | 2.64 |
| 2006 | 10 | 8 | 2.48 | 1.27 | 4.86 | 42 | 28 | 0.93 | 0.49 | 2.48 | 52 | 36 | 1.70 | 0.88 | 3.67 |
| 2007 | 5 | 3 | 1.98 | 1.46 | 2.32 | 58 | 38 | 0.92 | 0.59 | 2.99 | 63 | 41 | 1.45 | 1.03 | 2.66 |
| 2008 | 3 | 1 | 4.46 | 2.63 | 5.90 | 38 | 26 | 1.03 | 0.64 | 4.17 | 41 | 27 | 2.74 | 1.64 | 5.04 |
| 2009 | 5 | 4 | 1.96 | 1.15 | 2.77 | 36 | 20 | 0.93 | 0.64 | 1.79 | 41 | 24 | 1.44 | 0.90 | 2.28 |
| 2010 | 4 | 3 | 3.21 | 1.12 | 5.86 | 46 | 29 | 0.90 | 0.21 | 2.02 | 50 | 32 | 2.05 | 0.67 | 3.94 |
| 2011 | 1 | 1 | | | | 59 | 35 | 0.97 | 0.33 | 3.19 | 60 | 36 | 0.97 | 0.33 | 3.19 |
| 2012 | 44 | 31 | 2.99 | 0.05 | 10.49 | 53 | 31 | 1.30 | 0.14 | 5.43 | 97 | 62 | 2.15 | 0.10 | 7.96 |
| 2013 | 48 | 27 | 2.66 | 0.63 | 6.10 | 38 | 24 | 1.41 | 0.39 | 5.09 | 86 | 51 | 2.04 | 0.51 | 5.60 |
| 2014 | 51 | 30 | 1.89 | 0.43 | 6.20 | 24 | 18 | 1.89 | 0.69 | 11.86 | 75 | 48 | 1.89 | 0.56 | 9.03 |
| 2015 | 69 | 36 | 3.03 | 0.62 | 8.35 | 35 | 23 | 1.23 | 0.60 | 3.91 | 104 | 59 | 2.13 | 0.61 | 6.13 |
| 2016 | 66 | 31 | 3.17 | 0.77 | 7.16 | 19 | 15 | 1.18 | 0.39 | 4.30 | 85 | 46 | 2.18 | 0.58 | 5.73 |
| 2017 | 48 | 26 | 2.55 | 0.30 | 6.60 | 18 | 12 | 0.97 | 0.53 | 2.23 | 66 | 38 | 1.76 | 0.41 | 4.42 |
| 2018 | 71 | 33 | 2.58 | 0.60 | 7.49 | 23 | 15 | 1.35 | 0.55 | 5.01 | 94 | 48 | 1.96 | 0.58 | 6.25 |

Table 4.12.8. Number of age samples (number of trips intercepted) from the recreational fishery by year, state and mode.

| Year | Charter boat | | | Private | | Headboat | | | |
|------|--------------|---------|----------|---------|---------|----------|--------|--------|---------|
| | LA | AL | FL | AL | FL | TX | LA | AL | FL |
| 1979 | | | | | | | | | 11 (5) |
| 1980 | | | 9 (5) | | | | | | 17 (10) |
| 1981 | | | 12 (4) | | | | | | |
| 1986 | | | | | | 19 (15) | | | 9 (7) |
| 1987 | | | | | | 5 (4) | | | 2 (2) |
| 1988 | | | | | | 4 (3) | | | 8 (7) |
| 1989 | | | | | | | | | 19 (12) |
| 1990 | | | | | | 1 (1) | | | 3 (3) |
| 1991 | | | 5 (4) | | | 2 (1) | | | 16 (14) |
| 1992 | | | 10 (10) | | 1 (1) | 9 (6) | 3 (3) | | 39 (27) |
| 1993 | | | 10 (6) | | | 12 (8) | | | 18 (15) |
| 1994 | | | 59 (22) | | | 18 (11) | 4 (2) | | 31 (24) |
| 1995 | | | 51 (16) | | | 2 (2) | | | 30 (24) |
| 1996 | | | 113 (34) | | 5 (1) | | 1 (1) | | 37 (25) |
| 1997 | | | 27 (10) | | 1 (1) | | | | 21 (13) |
| 1998 | | | 47 (15) | | | | | | 6 (6) |
| 1999 | | | 45 (18) | | 2 (1) | | | | 5 (4) |
| 2000 | 1 (1) | | 3 (3) | | | | | 3 (2) | 4 (3) |
| 2001 | | | 6 (4) | | | | | | 2 (2) |
| 2002 | | | 52 (22) | | 7 (3) | | | 1 (1) | 23 (7) |
| 2009 | | 4 (2) | | 1 (1) | | | | | |
| 2010 | | 3 (3) | | 1 (1) | | | | | 1 (1) |
| 2011 | | 19 (15) | | | | | | | 1 (1) |
| 2012 | | | | | | 1 (1) | | | |
| 2013 | | | 111 (53) | | | 15 (10) | 13 (3) | 12 (6) | 24 (17) |
| 2014 | | | 121 (56) | | 14 (6) | 21 (13) | 3 (2) | 9 (5) | 13 (10) |
| 2015 | | | 148 (76) | | 17 (13) | 25 (18) | | 4 (3) | 41 (29) |
| 2016 | | 17 (5) | 158 (50) | | 26 (12) | 14 (11) | 10 (3) | 7 (6) | 34 (13) |
| 2017 | | | 71 (30) | | 5 (4) | 4 (3) | | 4 (4) | 44 (23) |
| 2018 | | | 28 (20) | | 4 (4) | | | | 22 (16) |
| 2019 | | | 3 (2) | | | | | | |

Table 4.12.9. Estimated SRHS headboat effort (in angler days) for Gulf of Mexico anglers. Due to headboat area definitions and confidentiality issues, estimates of SRHS effort are combined for: (i) Louisiana and Mississippi and (ii) Alabama and western Florida.

| Year | TX | LA/MS | FLW/AL | Total |
|------|---------|--------|---------|---------|
| 1986 | 56,568 | 5,891 | 240,077 | 302,536 |
| 1987 | 63,363 | 6,362 | 217,049 | 286,774 |
| 1988 | 70,396 | 7,691 | 195,948 | 274,035 |
| 1989 | 63,389 | 2,867 | 208,325 | 274,581 |
| 1990 | 58,144 | 6,898 | 213,906 | 278,948 |
| 1991 | 59,969 | 6,373 | 174,312 | 240,654 |
| 1992 | 76,218 | 9,911 | 184,802 | 270,931 |
| 1993 | 80,904 | 11,256 | 207,898 | 300,058 |
| 1994 | 100,778 | 12,651 | 204,562 | 317,991 |
| 1995 | 90,464 | 10,498 | 182,410 | 283,372 |
| 1996 | 91,852 | 10,988 | 154,913 | 257,753 |
| 1997 | 82,207 | 9,008 | 149,442 | 240,657 |
| 1998 | 77,650 | 7,854 | 185,331 | 270,835 |
| 1999 | 58,235 | 8,026 | 176,117 | 242,378 |
| 2000 | 58,395 | 4,952 | 159,331 | 222,678 |
| 2001 | 55,361 | 6,222 | 157,243 | 218,826 |
| 2002 | 66,951 | 6,222 | 141,831 | 215,004 |
| 2003 | 74,432 | 6,636 | 144,211 | 225,279 |
| 2004 | 64,990 | 0 | 158,430 | 223,420 |
| 2005 | 59,857 | 0 | 130,233 | 190,090 |
| 2006 | 70,789 | 5,005 | 124,049 | 199,843 |
| 2007 | 63,764 | 2,522 | 136,880 | 203,166 |
| 2008 | 41,188 | 2,945 | 130,176 | 174,309 |
| 2009 | 50,737 | 3,268 | 142,438 | 196,443 |
| 2010 | 47,154 | 715 | 111,018 | 158,887 |
| 2011 | 47,284 | 3,657 | 157,025 | 207,966 |
| 2012 | 51,776 | 3,680 | 161,975 | 217,431 |
| 2013 | 55,749 | 3,406 | 174,731 | 233,886 |
| 2014 | 51,231 | 3,257 | 191,365 | 245,853 |
| 2015 | 55,135 | 3,587 | 194,383 | 253,105 |
| 2016 | 54,083 | 2,955 | 199,978 | 257,016 |
| 2017 | 51,575 | 3,189 | 196,657 | 251,421 |
| 2018 | 52,160 | 3,235 | 191,847 | 247,242 |

Table 4.12.10. Total recreational fishing effort (in angler trips) for Gulf of Mexico anglers by mode and year (MRIP, SRHS, TPWD, and LA Creel). MRIP headboat estimates are used from 1981-1985 and SRHS from 1986+. The combined private-shore mode in the LA Creel survey is allocated as private fishing.

| Year | Cbt | Hbt | Priv | Total |
|------|-----------|---------|------------|------------|
| 1981 | 393,653 | 184,590 | 9,788,741 | 10,366,984 |
| 1982 | 523,703 | 260,912 | 11,539,636 | 12,324,250 |
| 1983 | 577,982 | 256,493 | 14,486,938 | 15,321,413 |
| 1984 | 538,634 | 242,211 | 14,092,265 | 14,873,111 |
| 1985 | 590,627 | 277,516 | 15,254,933 | 16,123,076 |
| 1986 | 568,071 | 330,173 | 14,774,401 | 15,672,645 |
| 1987 | 589,079 | 351,541 | 14,797,442 | 15,738,062 |
| 1988 | 514,257 | 359,278 | 17,206,317 | 18,079,852 |
| 1989 | 598,554 | 358,847 | 16,639,761 | 17,597,162 |
| 1990 | 582,562 | 374,904 | 17,643,786 | 18,601,252 |
| 1991 | 538,436 | 318,585 | 17,342,858 | 18,199,879 |
| 1992 | 562,637 | 343,636 | 17,960,471 | 18,866,744 |
| 1993 | 632,103 | 362,102 | 18,369,691 | 19,363,896 |
| 1994 | 674,540 | 390,133 | 18,879,440 | 19,944,112 |
| 1995 | 767,107 | 364,384 | 19,483,060 | 20,614,552 |
| 1996 | 728,968 | 337,152 | 19,486,760 | 20,552,880 |
| 1997 | 775,426 | 299,961 | 20,868,517 | 21,943,905 |
| 1998 | 770,950 | 326,333 | 22,378,087 | 23,475,370 |
| 1999 | 785,377 | 219,374 | 24,652,366 | 25,657,117 |
| 2000 | 764,302 | 298,776 | 24,235,439 | 25,298,517 |
| 2001 | 779,587 | 271,970 | 26,736,316 | 27,787,873 |
| 2002 | 747,306 | 260,044 | 25,968,811 | 26,976,162 |
| 2003 | 705,784 | 276,561 | 26,781,055 | 27,763,400 |
| 2004 | 784,050 | 275,804 | 30,051,274 | 31,111,128 |
| 2005 | 693,307 | 240,459 | 29,101,391 | 30,035,158 |
| 2006 | 824,855 | 248,496 | 27,001,186 | 28,074,537 |
| 2007 | 867,716 | 329,881 | 27,430,701 | 28,628,298 |
| 2008 | 815,284 | 214,982 | 29,704,327 | 30,734,593 |
| 2009 | 777,345 | 264,403 | 28,971,676 | 30,013,424 |
| 2010 | 598,246 | 209,111 | 30,041,475 | 30,848,832 |
| 2011 | 761,822 | 281,137 | 30,443,129 | 31,486,088 |
| 2012 | 942,070 | 301,077 | 31,766,244 | 33,009,390 |
| 2013 | 872,550 | 293,420 | 29,690,881 | 30,856,851 |
| 2014 | 864,446 | 312,881 | 23,290,379 | 24,467,706 |
| 2015 | 994,732 | 320,287 | 22,093,560 | 23,408,580 |
| 2016 | 1,058,564 | 326,815 | 23,433,797 | 24,819,176 |
| 2017 | 1,092,177 | 321,252 | 24,321,168 | 25,734,596 |
| 2018 | 1,230,739 | 316,205 | 22,674,462 | 24,221,405 |

4.13 FIGURES

Total Recreational Landings

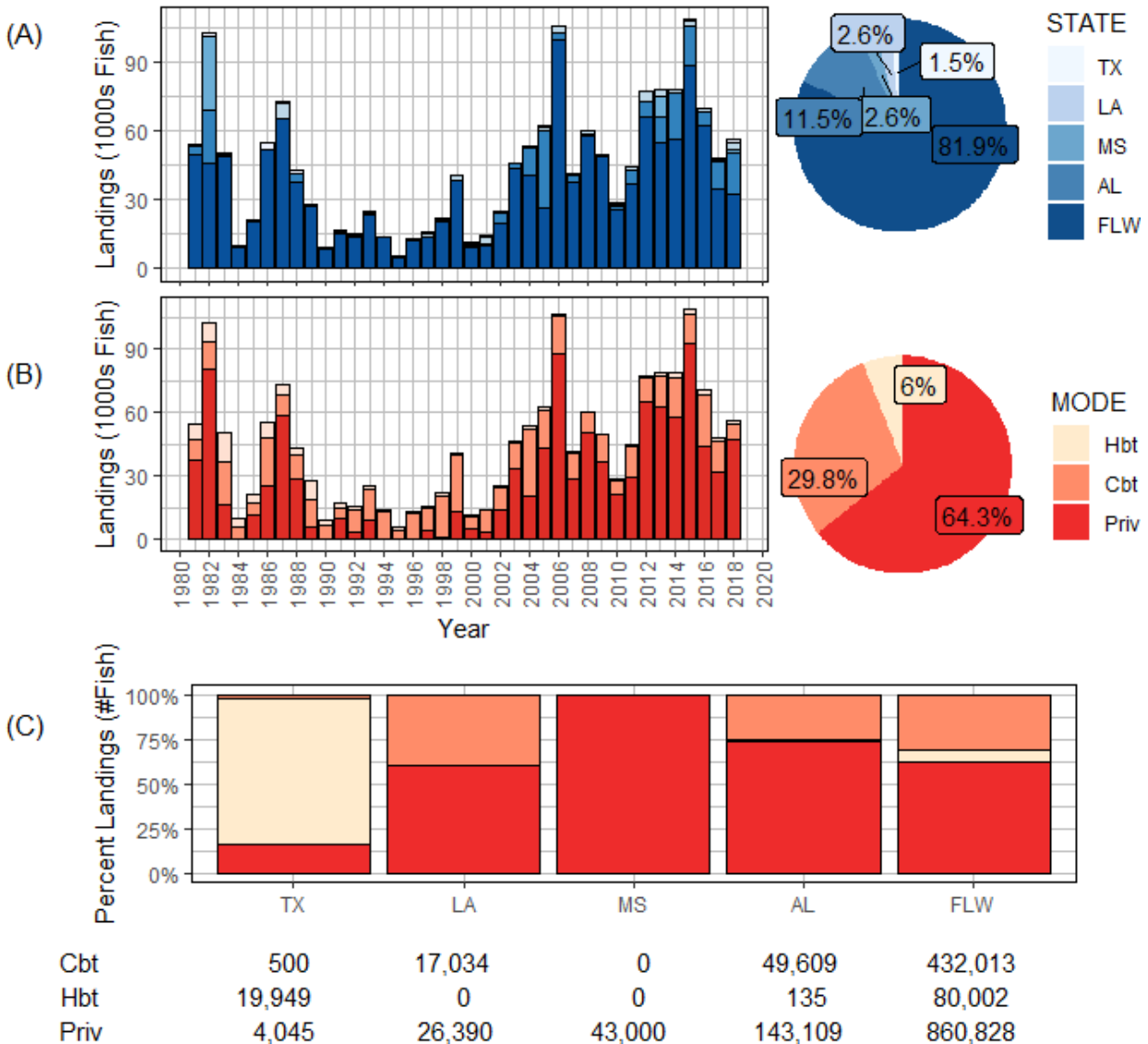

Figure 4.13.1. Total recreational landings (AB1) for Gulf of Mexico Scamp and Yellowmouth Grouper across all surveys (MRIP, SRHS, TPWD, and LA Creel). Landings are provided (A) by state and year (1981-2018) in thousands of fish, (B) by mode and year in thousands of fish, and (C) by mode and state in numbers of fish (as a percentage). MRIP landings estimates for western Florida exclude the Florida Keys. Due to headboat area definitions and confidentiality issues, estimates of SRHS landings are combined for: (i) Texas, Louisiana, and Mississippi and (ii) Alabama and western Florida, which are allocated as (i) Texas and (ii) western Florida landings respectively. MRIP headboat estimates are used from 1981-1985 and SRHS from 1986+. The combined private-shore mode in the LA Creel survey is allocated as private fishing.

**Total Recreational Landings (1981-2018)
Gulf of Mexico Scamp and Yellowmouth Grouper**

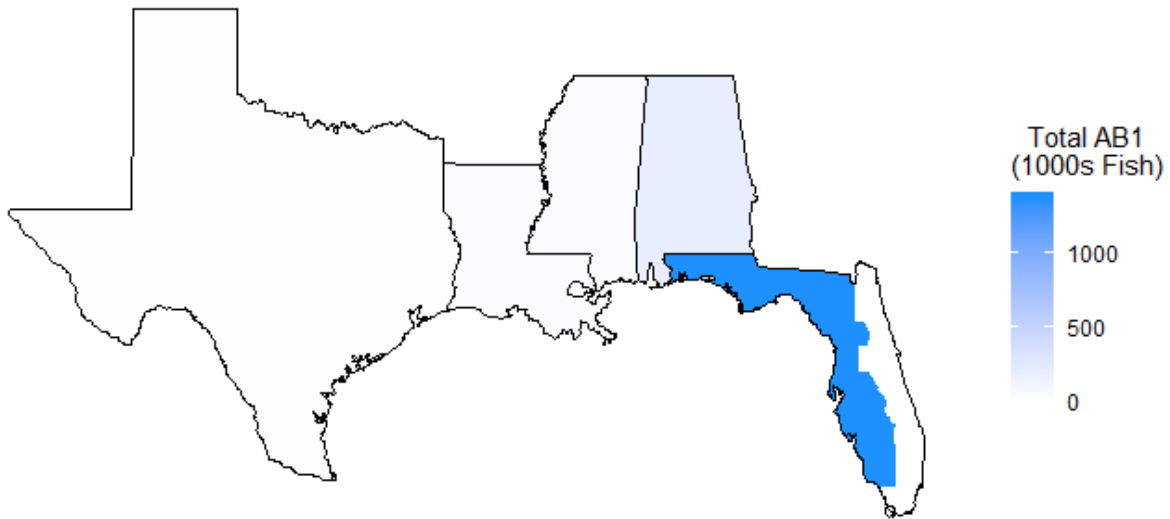

Figure 4.13.2. Distribution of total recreational landings (AB1), in thousands of fish, for Scamp and Yellowmouth Grouper across the Gulf of Mexico. Estimates are combined across all surveys (MRIP, SRHS, TPWD, and LA Creel) and years (1981-2018). MRIP landings estimates for western Florida exclude the Florida Keys. Due to headboat area definitions and confidentiality issues, estimates of SRHS landings are combined for: (i) Texas, Louisiana, and Mississippi and (ii) Alabama and western Florida, which are allocated as (i) Texas and (ii) western Florida landings respectively.

Total Recreational Discards

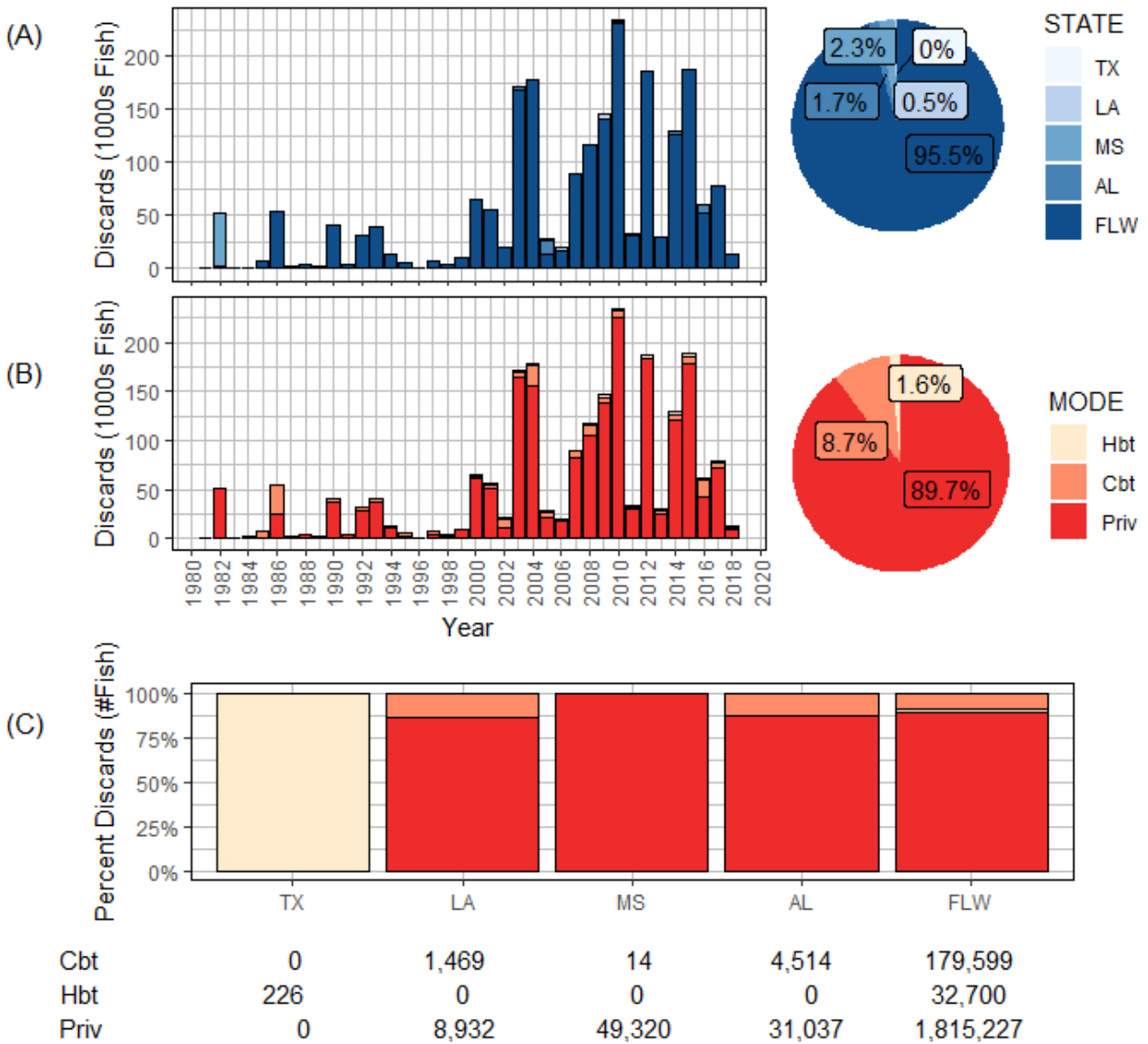

Figure 4.13.3. Total recreational discards (B2) for Gulf of Mexico Scamp and Yellowmouth Grouper across all surveys (MRIP, SRHS, TPWD, and LA Creel). Discards are provided (A) by state and year (1981-2018) in thousands of fish, (B) by mode and year in thousands of fish, and (C) by mode and state in numbers of fish (as a percentage). MRIP discards estimates for western Florida exclude the Florida Keys. Due to headboat area definitions and confidentiality issues, estimates of SRHS discards are combined for: (i) Texas, Louisiana, and Mississippi and (ii) Alabama and western Florida, which are allocated as (i) Texas and (ii) western Florida discards respectively. MRIP headboat estimates are used from 1981-1985 and SRHS from 1986+. The combined private-shore mode in the LA Creel survey is allocated as private fishing.

**Total Recreational Discards (1981-2018)
Gulf of Mexico Scamp and Yellowmouth Grouper**

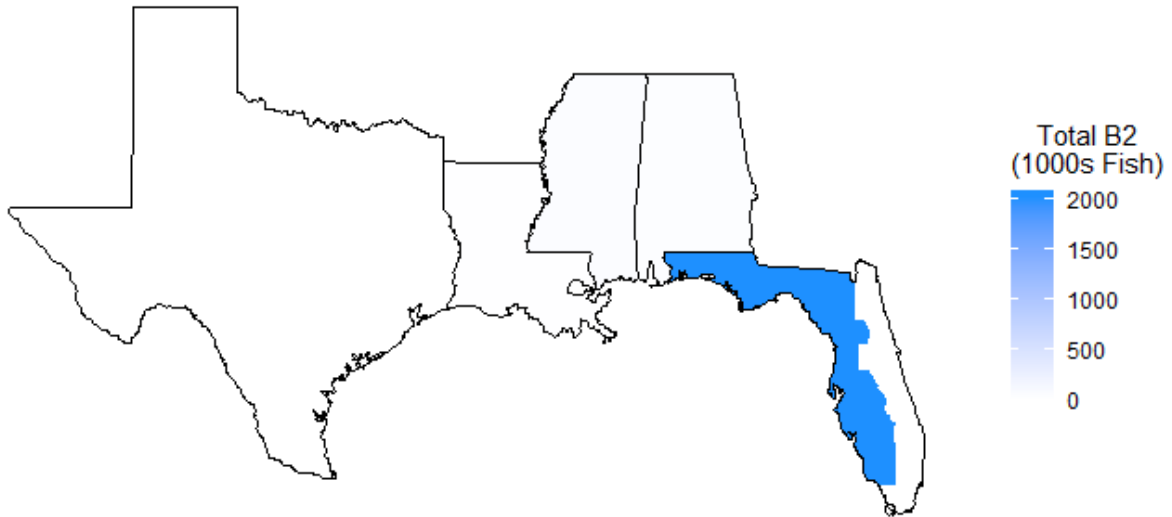

Figure 4.13.4. Distribution of total recreational discards (B2), in thousands of fish, for Scamp and Yellowmouth Grouper across the Gulf of Mexico. Estimates are combined across all surveys (MRIP, SRHS, TPWD, and LA Creel) and years (1981-2018). MRIP discards estimates for western Florida exclude the Florida Keys. Due to headboat area definitions and confidentiality issues, estimates of SRHS discards are combined for: (i) Texas, Louisiana, and Mississippi and (ii) Alabama and western Florida, which are allocated as (i) Texas and (ii) western Florida discards respectively.

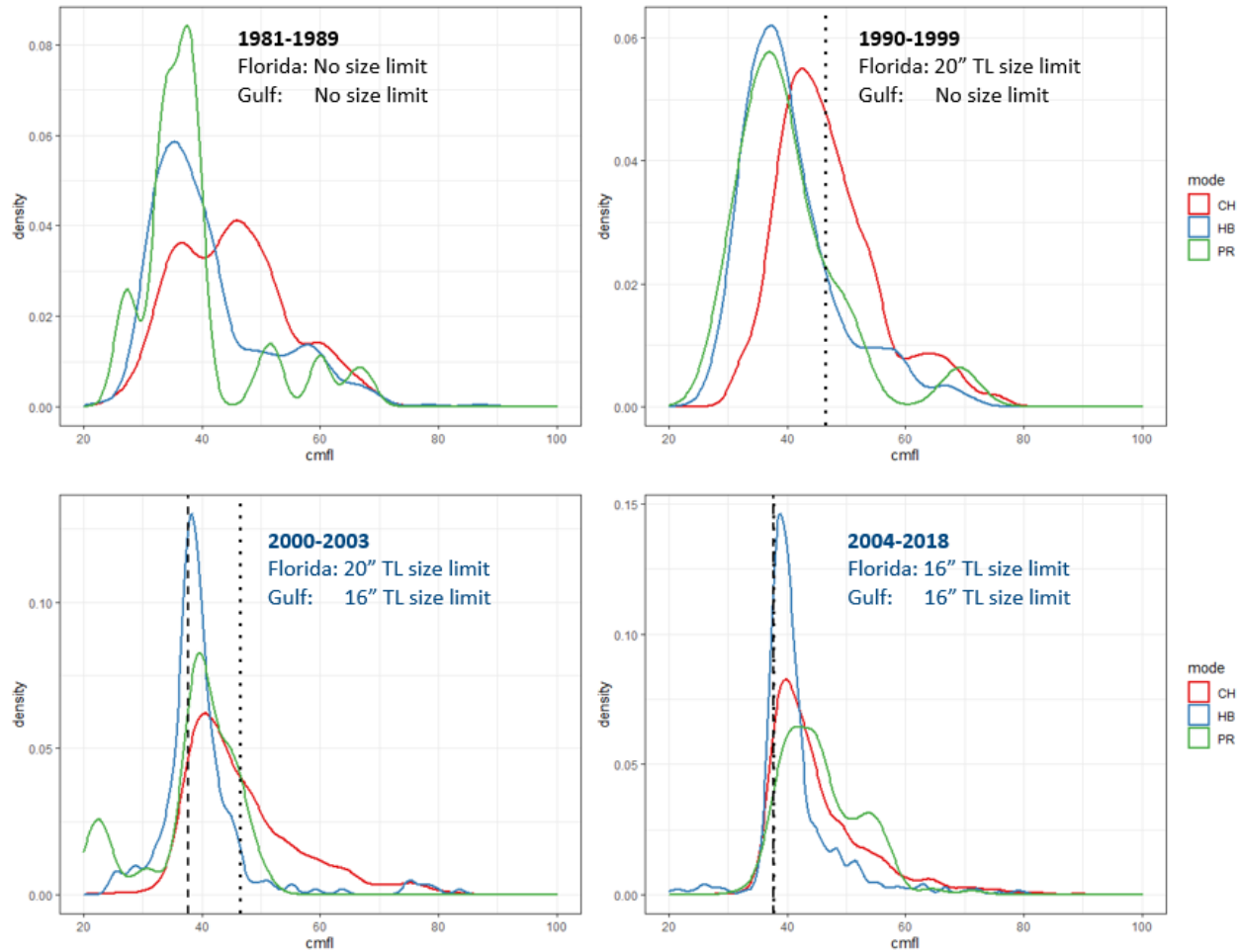

Figure 4.13.5. Florida landings length frequency distributions of recreational fleets (CH=Charter boat, PR=Private, HB=Headboat) by management period. The top two panels represent a single management period, and the bottom two show the impacts of the federal 16" TL size limit.

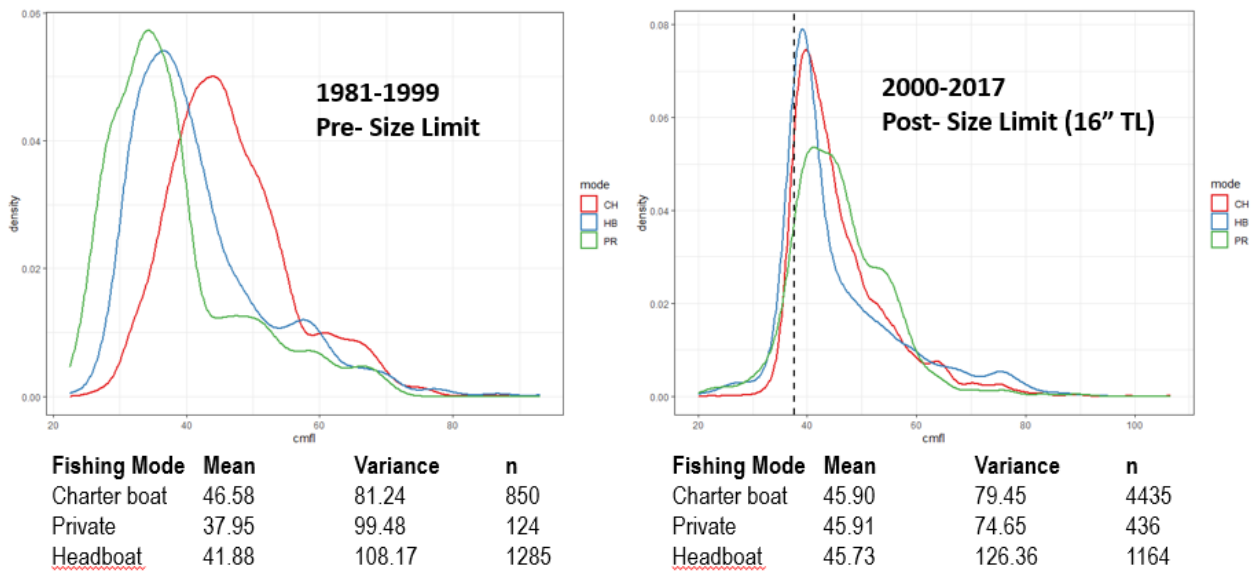

Figure 4.13.6. Length frequency distributions of recreational landings by mode (CH=Charter boat, PR=Private, HB=Headboat) pre- and post- size limit. Mean, variance, and sample size (n) are included for each time period.

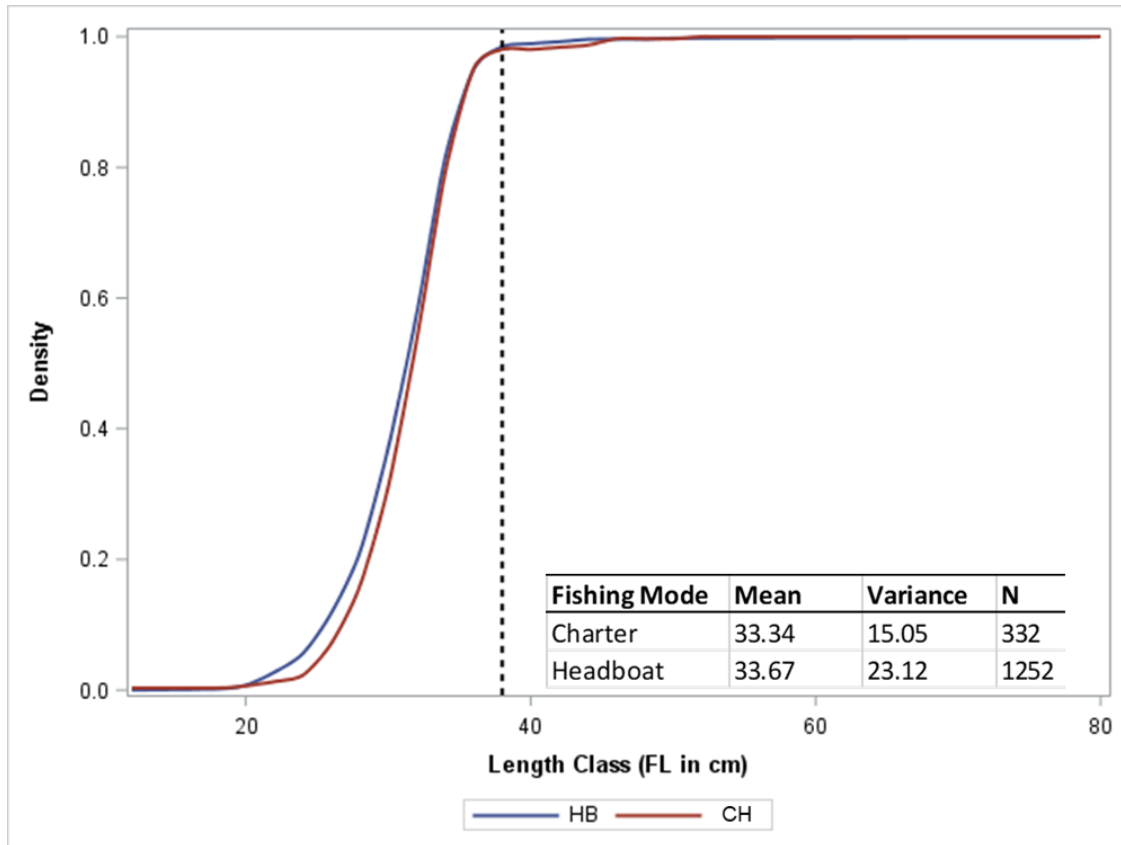

Figure 4.13.7. Cumulative frequency distribution for Scamp and Yellowmouth Grouper discard lengths collected from the Gulf of Mexico headboat and charter boat fisheries from 2005 to 2017, all years combined. The dotted line represents the fork length associated with the current Gulf of Mexico recreational minimum size limit of 16 inches total length.

Total Recreational Effort

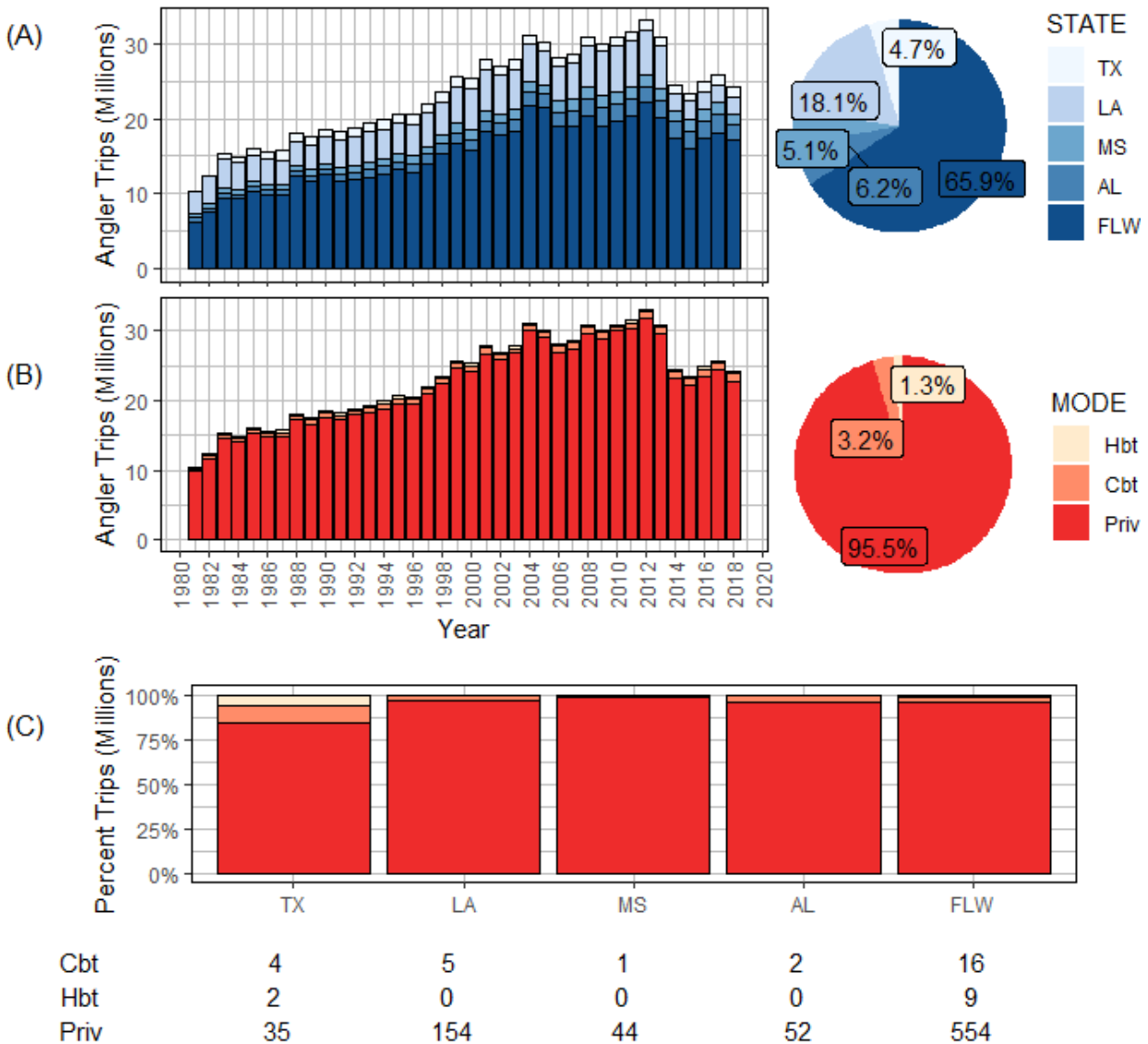

Figure 4.13.8. Total recreational fishing effort for Gulf of Mexico anglers in millions of angler trips (MRIP, SRHS, TPWD, and LA Creel). Effort is provided (A) by state and year (1981-2018), (B) by mode and year, and (C) by mode and state (as a percentage). MRIP effort estimates for western Florida exclude the Florida Keys. Due to headboat area definitions and confidentiality issues, estimates of SRHS effort are combined for: (i) Louisiana and Mississippi and (ii) Alabama and western Florida, which are allocated as (i) Louisiana and (ii) western Florida effort respectively. MRIP headboat estimates are used from 1981-1985 and SRHS from 1986+. The combined private-shore mode in the LA Creel survey is allocated as private fishing.

Total Recreational Fishing Effort (1981-2018) Gulf of Mexico Anglers

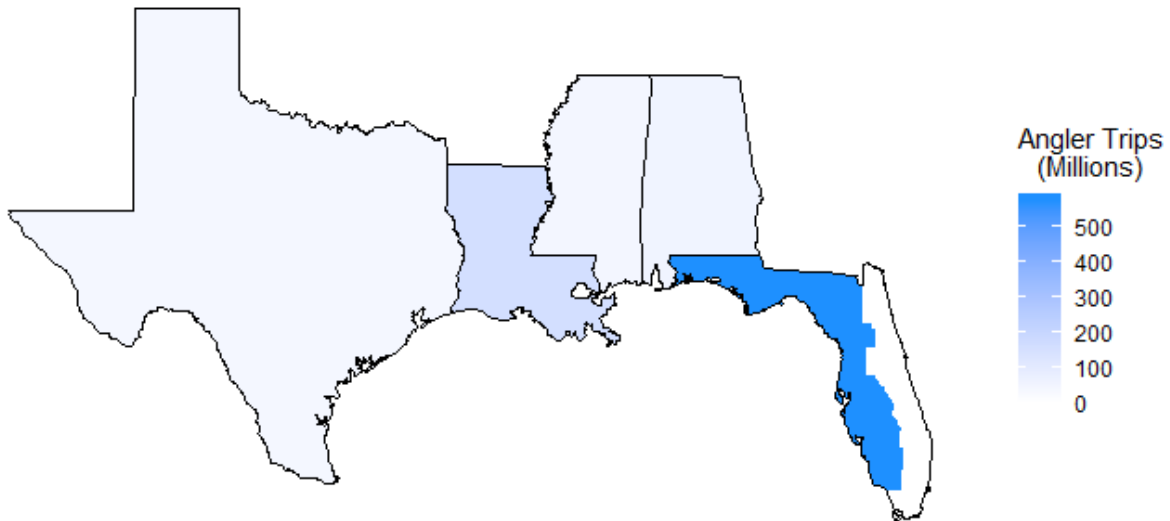

Figure 4.13.9. Distribution of total recreational fishing effort by Gulf of Mexico anglers. Estimates are combined across all surveys (MRIP, SRHS, TPWD, and LA Creel) and years (1981-2018). MRIP effort estimates for western Florida exclude the Florida Keys. Due to headboat area definitions and confidentiality issues, estimates of SRHS effort are combined for: (i) Louisiana and Mississippi and (ii) Alabama and western Florida, which are allocated as (i) Louisiana and (ii) western Florida effort respectively.

5 INDICES OF POPULATION ABUNDANCE

5.1 OVERVIEW

For the Gulf of Mexico (GOM) U.S. region, three fishery-independent data sets were considered for use in developing an index of abundance (Table 5.1). Only one was retained for use in this assessment following discussions at the DW, the combined video survey.

For the GOM U.S. region, seven fishery-dependent data sets were considered for use in developing an index of abundance (Table 5.1). Ultimately, the DW recommended indices from three of these fishery-dependent data sets for potential use in the assessment model: recreational

headboat logbook index, commercial pre-Individual Fishing Quota (pre-IFQ) vertical line logbook index, and a novel reef-fish observer index characterizing the commercial vertical line fishery. An emerging fishery dependent, video and electronic monitoring survey conducted by Mote Marine Laboratory was also presented; however, the limited time series prevented consideration of this index for this assessment. This data source was presented during this research track as an introduction for future assessments, with its utility likely to increase as its spatial coverage increases and additional years of data are collected.

In total, the DW recommended one fishery-independent index (combined video survey) and three fishery-dependent indices (recreational headboat index, commercial pre-IFQ vertical line index, and reef-fish observer index) for potential use in the Scamp and Yellowmouth Grouper stock assessment. These indices are listed in Table 5.1, with pros and cons of each in Table 5.2.

5.1.1 Group membership

Membership of this DW Index Working Group (IWG) included Nate Bacheler, Wally Buble, Rob Cheshire, Eric Fitzpatrick, Chris Gardner, Robert Leaf, Kevin McCarthy, Kate Overly, Will Patterson, Skyler Sagarese, Alexei Sharov, Kyle Shertzer, Tracy Smart, Ted Switzer, Kevin Thompson and Jim Tolan. Several other DW panelists and observers contributed to the IWG discussions throughout the Data Workshop webinars.

5.2 REVIEW OF WORKING PAPERS

The relevant working papers describing index construction were presented to the IWG (SEDAR 68-DW-06, SEDAR 68-DW-07, SEDAR 68-DW-14, SEDAR 68-DW-18, SEDAR 68-DW-29, and the observer index WP, SEDAR 68-DW-XX). In most cases, the IWG recommended modifications to the initial modeling attempts, such that data treatments and/or model specifications were updated during the DW. Final working papers reflect decisions made during the DW, using addenda if necessary.

The index working papers provide information on methodology, sample sizes, diagnostics of model fits, and in some cases, maps of catch and effort. A summary of each index is provided below.

5.3 FISHERY-INDEPENDENT INDICES

5.3.1 Combined stereo-video index

Historically, three different stationary video surveys were conducted for reef fish in the GOM. The NMFS SEAMAP reef fish video survey, carried out by NMFS Mississippi Laboratory (Pascagoula), has the longest running time series (1993-1997, 2002, and 2004+) on primarily deep, high relief habitats. This was followed by the NMFS Panama City lab survey (PC; 2005+), with the most recent survey being the Florida Fish and Wildlife Research Institute video survey (FWRI, starting year 2010; Table 1 in SEDAR68-DW-07). While the surveys use standardized deployment, camera field of view, and fish abundance methods to assess fish abundance on reef or structured habitat, there are variations in survey design and habitat characteristics collected in addition to the time period and area sampled. Traditionally each survey has submitted independent indices, however, combining indices across datasets likely increases predictive capabilities by allowing for the largest possible sample sizes in model fitting and encompassing a greater proportion of the distribution of the stock. Previous research has indicated that combining data across changing spatial areas and surveys and using a year only model, can yield spurious conclusions regarding stock abundance (Campbell 2004; Ye et al. 2004). As such, a habitat-based approach was used to combine relative abundance data for generating annual trends for Scamp throughout the GOM.

5.3.1.1 Methods of Estimation

Data Filtering

For all surveys, video reads were excluded if they were unreadable due to turbidity or deployment errors. For the Pascagoula survey, data included in this index are from 1993 and on, due to different counting methods in 1992. The entire spatial extent of the Panama City data was used from 2006 on with 2005 excluded because of an incomplete survey. For the FWRI data, prior to 2010 was excluded due to the earlier years not including side-scan geform as a variable which was determined to be important as an explanatory variable in the analyses. FWRI data were spatially limited to zones 4 and 5 due to the other areas of the WFS not having enough years of sampling. These zones represent key areas where Scamp are caught (SEDAR68-SID-05).

For this assessment, the Stock ID Workshop and initial scoping calls indicated that data should be combined for Scamp and the congener Yellowmouth Grouper (*Mycteroperca interstitialis*) due to difficulties distinguishing them apart across all gears and surveys. As such, the MaxN

values used were the sum of Scamp and Yellowmouth Grouper. However, counts of Yellowmouth Grouper were rare in the PC and FWRI survey (less than 3 observations total) so they were excluded for those datasets. Pascagoula's survey had more occurrences of Yellowmouth Grouper or fish deemed to be either Yellowmouth or Scamp (45 occurrences for a total of 52 fish) and therefore these observations were included in analyses.

Model Description

Response and explanatory variables

The response variable, MaxN, is the maximum number of individuals of each species viewed in a single frame within a 20-minute time frame for each site sampled.

Years-categorical from 1993-2018

Survey-the categorical survey that the site was part of; Pascagoula East, Pascagoula West, Panama City, and FWRI

Hab- categorical variable designating the quality of the habitat for each site as Fair, Good or Poor. Assigned by individual survey CART analyses using several variables regarding space, habitat at the landscape level, and localized, visual described habitats (e.g. presence of sponge). Variables were across surveys however some were survey specific. Additional details are provided in SEDAR68-DW-07.

Standardization

The index was fit using a Generalized Linear Model (GLM) with a negative binomial distribution. The estimated MaxN means provided by the GLM were adjusted to account for the variation in survey area, differences in area mapped with known habitat, and the distribution of Fair, Good, and Poor habitats by survey by year. The known potential survey universe for each of the three surveys was first multiplied by the proportion of habitat mapping grids that had reef habitat to provide an area weight. This was then multiplied by each year x Survey x hab combination (up to 12 for the final years with three surveys and three habitat levels), providing a weighting factor for each of the mean estimates. Weighted index values were then standardized to the grand mean.

5.3.1.2 Sampling Intensity

The resulting data set used in creating this index was over 10,000 video samples, with larger sample sizes in later years as surveys were added to the time series. Sets with Scamp present were between ~15% and 40% depending upon the year (Table 5.3).

5.3.1.3 Size/Age data

Collection and processing of fish length measurements have varied through time for the surveys. Starting with the Pascagoula survey in 1995, fish lengths were measured from video using lasers attached on the camera system with known geometry. The Panama City survey also used this laser-based approach from 2007 to 2009. However, the frequency of hitting targets with the laser was low and to increase sample size any measurable fish during the video read was measured (i.e. not just at the MaxN). Therefore, fish could have potentially been measured twice. Subsequent years from 2008 in Pascagoula and 2010 in Panama City used a stereo-video approach, which is the only method used in the entirety of the FWRI dataset. Vision Measurement System (VMS, Geometrics Inc.) was used to estimate size of fish up to 2014 for all three surveys and all switched to SeaGIS software (SeaGIS Pty. Ltd.) and have used them for the remainder of the timeseries. Length composition data were compared across the surveys to check that similar sized fish were targeted by each survey. No age data are collected during video surveys.

5.3.1.4 Catch Rates

Standardized catch rates and associated error bars are shown in Figure 5.1 and tabulated in Table 5.3. The unit of annual abundance is average MaxN for each year, relativized to the grand mean.

5.3.1.5 Uncertainty and Measures of Precision

Annual CVs of MaxN were calculated from the weighted model standard errors and means and are tabulated in Table 5.3.

5.3.1.6 Comments on Adequacy for Assessment

The index of abundance created from the combined stereo video survey was considered by the IWG to be adequate for use in the assessment. Initial presentations of this index only included data from the eastern GOM, following previous assessments where this approach has been applied with species that were not abundant in the western GOM (e.g., Red Grouper, SEDAR61)

or were assessed with two regional sub models (e.g., Vermilion Snapper, SEDAR67). As such, following discussions in the IWG, this index was adjusted for the first incorporation of western GOM data from the Pascagoula survey along with the standard eastern Pascagoula, Panama City and FWRI datasets. Following this adjustment, the opinions of the IWG were that this index was of significant value given the fishery-independent nature of the data, its lengthy time series, geographic scope and gear that allowed for the largest possible range of fish lengths to be observed on a wide variety of habitats. Further details regarding sampling and model fitting, especially regarding survey-specific habitat models can be reviewed in SEDAR 68-DW-07.

5.4 FISHERY-DEPENDENT INDICES

In general, indices derived from fishery-independent surveys are believed to represent abundance more accurately than those from fishery-dependent data sources. This is because fishery-dependent indices can be strongly affected by factors other than abundance, such as management regulations on the focal or other species, shifts in targeting, changes in fishing efficiency (technology creep), and density-dependent catchability (hyperdepletion or hyperstability). The standardization procedures attempt to account for some of these issues to the extent possible.

5.4.1 *Recreational Headboat Index*

Rod and reel catch and effort from party (head) boats in the GOM have been monitored by the NMFS Southeast Region Headboat Survey (conducted by the NMFS Beaufort Laboratory) since 1986. The Headboat Survey collects data on the catch and effort for a vessel trip. Reported information includes landing date and location, vessel identification, the number of anglers, a single fishing location (10' x 10' rectangle of latitude and longitude) for the entire trip, trip duration and/or type (half/three-quarter/full/multi-day, day/night, morning/afternoon), and catch by species in number and weight. These data were used to construct an index of Scamp and Yellowmouth Grouper catch rates in the GOM. The index was constructed using Generalized Linear Models, and a delta-lognormal approach.

Catch per unit effort (CPUE) for each trip was estimated as the number of Scamp and Yellowmouth Grouper landed on a trip divided by the fishing effort, where effort was the product of the number of anglers and the total hours fished. To estimate effort for each trip type

(i.e., trip duration), the following assumptions were adopted: Half day trip = 5 hours fished; Three-quarter day trip = 7.5 hours fished, and Full day trip = 10 hours fished.

5.4.1.1 Methods of Estimation

Data Filtering

Observations were included from all states across the GOM and from half-day trips, three-quarter day trips, and full-day trips. Data were excluded from analyses for vessels that had fewer than 30 trips in the headboat logbook database and for trips with six or fewer anglers. Trips with possible errors in catch and effort information and trips during the closed season for shallow-water groupers were excluded. Lastly, the top 0.5% of values for catch, CPUE, and the number of anglers were excluded from analyses.

The Stephens and MacCall (2004) approach was used to restrict the dataset to trips that likely encountered Scamp and Yellowmouth Grouper. This approach uses the species composition of each trip in a logistic regression of species presence/absence to infer if effort on a given trip occurred in habitat similar to that preferred by Scamp and Yellowmouth Grouper. This approach was applied separately for the Eastern and Western U.S. GOM due to suspected differences in species compositions between regions. In applying the Stephens and MacCall (2004) approach, the species considered in this analysis were limited to reef fish species that were on the headboat logbook forms across all years and species without seasonal or quota closures in recent years.

Standardization

A two-stage delta-lognormal generalized linear model (GLM; Lo et al. 1992) was used to develop standardized catch rate indices. This method combines two separate GLM analyses of the proportion of trips that caught at least one Scamp and Yellowmouth Grouper (i.e., proportion of positive trips) and the catch rates of the positive trips to construct a single standardized index of abundance. A forward stepwise approach was used during the construction of each GLM. The factors in the table below were examined as possible influences on the proportion of positive trips, and the catch rates on positive trips.

Submodel Variables

| Factor | DF | Details |
|------------|----|---------------------------------------|
| Year | 32 | 1986-2017 |
| Season | 4 | Dec-Feb, Mar-May, Jun-Aug, Sep-Nov |
| Area | 4 | CenTX_SWTX, NWFL_AL, NWTX_LA, SW_FL |
| Trip Type* | 3 | Full day, Half day, Three quarter day |
| Anglers* | 7 | 7-10, 11-20, 21-30, 41-50, 51-60, 61+ |

*Only explored as factors for modeling success because these factors were confounded with effort for the CPUE response variable in the lognormal model.

Once a set of fixed factors was identified, first level interactions were examined.

YEAR*FACTOR interaction terms were included in the model as random effects. The final delta-lognormal model was fit using the SAS macro GLIMMIX (glmm800MaOB.sas: Russ Wolfinger, SAS Institute) and the SAS procedure PROC MIXED (SAS Institute Inc. 1997) following the procedures by Lo et al. (1992). The variation in catch rates by vessel was examined using a “repeated measures” approach (Littell et al., 1998). The term ‘repeated measures’ refers to multiple measurements taken over time on the same experimental unit (i.e. vessel). Specifying the repeated measure “VESSEL” and the subject “VESSEL(YEAR)” allows PROC MIXED to model the covariance structure of the data. This is particularly important because catch rates may vary by vessel and because catch rates by a given vessel that are close in time can have a higher correlation than those far apart in time (Littell et al., 1998).

Annual Abundance Indices

The final models for the binomial and lognormal components were:

Proportion Positive = YEAR

$\ln(\text{CPUE}) = \text{YEAR} + \text{AREA} + \text{SEASON} + \text{YEAR} * \text{AREA}$

5.4.1.2 Sampling Intensity and Time Series

Table 5.4 shows the annual number of trips and the number of positive trips that were included in this analysis.

5.4.1.3 Size/Age Data

Recreational size limits for Scamp have been in place since 1990 in Florida state waters, where the size limit remained at 20 inches total length (TL) until 2002. The federal size limit of 16 inches TL was imposed in late 1999. It is assumed that the size range of Scamp targeted by headboats is comprised of legal sized fish.

5.4.1.4 Catch Rates

Standardized catch rates are presented in Table 5.4 and Figure 5.2.

5.4.1.5 Uncertainty and Measures of Precision

Annual CVs of catch rates are presented in Table 5.4.

5.4.1.6 Comments on Adequacy for Assessment

The headboat index was deemed adequate for use in the assessment by the IWG. This decision was largely based on the long time series and large spatial coverage associated with the Headboat Survey, as this survey often represents the longest time series for GOM reef fish stocks. For Scamp, the lack of targeting by anglers suggests that this index may be reflective of abundance, which was a topic of discussion by the IWG. The final headboat index recommended for the GOM was based on improved data filtering and modifications to the trip selection approach as used in the South Atlantic region and detailed in SEDAR68-DW-18. Developing the GOM index using these enhanced procedures as applied in Beaufort was possible during this research track because time allowed a thorough comparison of how both NMFS Beaufort and NMFS Miami develop indices of abundance. Ultimately, and after confirming that there were no clear trends in nominal CPUE between the Eastern and Western GOM, the IWG supported the final headboat index discussed in SEDAR69-DW18.

Additional research was suggested, including the need to explore alternative trip selection approaches which may be more appropriate for the U.S. Gulf of Mexico and South Atlantic recreational fisheries.

5.4.2 Coastal Fisheries Logbook Program

The National Marine Fisheries Service (NMFS) collects information on catch and fishing effort from the commercial fishing industry in the Southeastern Region through the Southeast Fisheries

Science Center's Coastal Fisheries Logbook Program (CFLP). Individuals who carry commercial federal fishing permits are required to provide information on their landings and fishing effort for each trip that they take. The CFLP in the GOM began in 1990 with the objective of a complete census of reef fish fishery permitted vessel activity. Florida was the exception, where a 20% sample of vessels was targeted. Beginning in 1993, the sampling in Florida was increased to require reports from all vessels permitted in the reef fish fishery and a complete census was obtained.

The CFLP collects data on the catch and effort for individual commercial fishing trips. Reported information includes a unique trip identifier, the landing date, fishing gear deployed, areas fished (equivalent to NMFS shrimp statistical grids), number of days at sea, number of crew, gear specific fishing effort, species caught and whole weight of the landings. Logbook data were used to characterize abundance trends of Scamp and Yellowmouth Grouper in the U.S. GOM, with catch-per-unit-effort (CPUE) calculated on an individual trip basis for each fishery.

The implementation of the Grouper-Tilefish Individual Fishing Quota (IFQ) program in 2010 by Amendment 29 aimed to reduce overcapacity of the grouper-tilefish fishing fleet, increase harvesting efficiency, and eliminate the race to fish. Additional information on the IFQ program can be found at the NMFS's Southeast Regional Office webpage on limited access programs at <http://portal.southeast.fisheries.noaa.gov/cs/main.html>. This major change to the fishery, which has been suggested to impact fishing behavior and potentially catchability, has resulted in the exploration and development of separate indices both pre- and post-IFQ for GOM reef fish in recent stock assessments (Red Grouper, SEDAR 42 and Gag Grouper, SEDAR 33).

Indices were developed for Scamp and Yellowmouth Grouper for both the pre-IFQ and IFQ time periods. Pre-IFQ indices were developed for the vertical line and longline fisheries separately for the years 1993 to 2009. Post-IFQ indices were developed for the vertical line and longline fisheries for the years 2010 to 2017. All indices used data from the Coastal Fisheries Logbook Program and were developed following standardization methodologies consistent with previous analyses for other GOM grouper species. Improved data filtering techniques and modifications to

the trip selection approach were made as implemented in the South Atlantic region.

CFLP Data Filtering

General data exclusions using CFLP data for analyses were as follows:

12. Multiple areas fished may be recorded for a single fishing trip. In such cases, assigning catch and effort to specific locations was not possible; therefore, only trips in which one area fished was reported were included.
13. Multiple fishing gears may be recorded for a single fishing trip. In such cases assigning catch and effort to a particular gear type was not possible. Trips fishing multiple gears were excluded in these analyses.
14. Logbook reports submitted 45 days or more after the trip completion data were excluded due to the lengthy gap in reporting time.

5.4.3 Commercial Vertical Line

Electric reel (bandit) and manual handline were combined into a single vertical line fishery as they are often reported together on the same trip, or one gear may be reported in place of the other. As a result, it is not possible to apportion fishing effort separately by electric or manual handlines. Fishing effort data available for handline and electric reel (bandit gear) trips include the number of lines fished, total hours fished, and the number of hooks per line.

5.4.3.1 Methods of Estimation

Data Filtering Techniques

Data exclusions using CFLP data subset to vertical line trips for analyses (both pre- and post-IFQ where applicable) for Scamp and Yellowmouth Grouper were as follows:

- A. Vertical line trips with reported fishing more than 24 hours per day were excluded.

- B. Trips that fell outside the 99.5th percentile were considered to represent mis-reported data or data entry errors and were excluded for the following variables: number of, number of hooks per line, the hours fished per day, number of hook hours, the number of days at sea (trip duration), and the number of crew members.
- C. Seasonal closures and regulatory closures have been employed to manage the commercial shallow-water grouper fishery. Closures in the pre-IFQ period were implemented on the following dates: November 15, 2004 – December 31, 2004; and October 10, 2005 – December 31, 2005. The dataset was restricted to time periods for which fishing on Scamp and Yellowmouth Grouper was allowed.
- D. No shallow-water grouper trip limits were reached between 2005 and 2008 in the pre-IFQ period.

The Stephens and MacCall (2004) multispecies approach was used to restrict the dataset to trips that likely encountered Scamp and Yellowmouth Grouper. This approach uses the species composition of each trip in a logistic regression of species presence/absence to infer if effort on that trip occurred in similar habitat occupied by Scamp and Yellowmouth Grouper. This approach was applied separately for the Eastern and Western GOM due to suspected differences in species compositions between regions. In applying the Stephens and MacCall (2004) approach, the species considered were limited to reef fish species. Lastly, any trips that may have caught exclusively Scamp and Yellowmouth Grouper were kept in the dataset and included in the analysis following previous decisions for other GOM grouper analyses.

For the pre-IFQ period, the percentage of trips catching Scamp and Yellowmouth Grouper was 21-23% on average before trip selection and 65% after trip selection for both the Eastern and Western GOM. For the post-IFQ period, the percentage of trips catching Scamp and Yellowmouth Grouper was 25-29% on average before trip selection and 72-83% after trip selection for both the Eastern and Western GOM.

Catch rate calculation

For the vertical line fishery, CPUE for each trip was defined as the whole weight of Scamp and Yellowmouth Grouper landed on a trip divided by the effort, where effort was the product of the number of lines fished, the hooks per line, and the total hours fished. For each trip, CPUE was calculated as:

$$\ln(\text{CPUE}) = \ln(\text{whole pounds of Scamp and Yellowmouth Grouper}) / (\text{number of lines fished} \times \text{hooks per line} \times \text{total hours fished})$$

Standardization

The delta lognormal modeling approach (Lo et al. 1992) was used to construct the standardized indices of abundance. Parameterization of each model was accomplished using the GENMOD procedure of SAS 9.2 (SAS Institute, 2008) to quantify the relative importance of the explanatory factors. For the GLM analysis of proportion positive trips, the response variable was the proportion of successful trips, a type-3 model was fit, a binomial error distribution was assumed, and the logit link function was selected. For the GLM analysis of catch rates on successful trips, the response variable was $\ln(\text{CPUE})$, a type-3 model was fit, a lognormal error distribution was assumed, and the normal link function was selected. All two-way interactions among significant main effects were examined. Higher order interaction terms were not examined.

A forward stepwise regression procedure was used to determine the set of fixed factors and interaction terms that explained a significant portion of the observed variability. Each potential factor was added to the null model sequentially and the resulting reduction in deviance per degree of freedom was examined. The factor that caused the greatest reduction in deviance per degree of freedom was added to the base model if the factor was significant based upon a Chi-Square test ($p < 0.05$), and the reduction in deviance per degree of freedom was $\geq 1\%$. This model then became the base model, and the process was repeated, adding factors and interactions individually until no factor or interaction met the criteria for incorporation into the final model. Once a set of fixed factors was identified, the influence of the YEAR*FACTOR interactions was examined. YEAR*FACTOR interaction terms were included in the model as random effects. Selection of the final model was based on the Akaike's Information Criterion (AIC) and a Chi-Square test of the difference between the negative log likelihood statistics between successive

model formulations (Littell et al. 1996). The final delta-lognormal models were fit using the SAS GLIMMIX macro (Russ Wolfinger, SAS Institute). To facilitate visual comparison, relative indices and relative nominal CPUE series were calculated by dividing each value in the series by the mean CPUE of the series.

Submodel Variables

Pre-IFQ

For the pre-IFQ index construction, five factors were considered as possible influences on the proportion of trips that landed Scamp and Yellowmouth Grouper and on the catch rate of Scamp and Yellowmouth Grouper. An additional factor, number of hook hours fished (indicated by gray and an *), was examined solely for its effect on the proportion of positive trips because this factor was confounded with effort for the CPUE response variable in the lognormal model. In order to develop a well-balanced sample design, it was necessary to define categories within some of the factors examined:

| Factor | DF | Details |
|----------|----|--|
| Year | 17 | 1993-2009 |
| Month | 12 | Jan, Feb, Mar, Apr, May, Jun, Jul, Aug, Sep, Oct, Nov, Dec |
| Area | 4 | 1 (areas 1-7), 2 (area 8), 3 (areas 9-11), 4 (areas 12-21) |
| Crew | 3 | 1 (1-2 crew), 2 (3 crew), 3 (4-6 crew) |
| Away | 4 | 1 (1-2 days), 2 (3-4 days), 3 (5-6 days), 4 (7-12 days) |
| Hookhrs* | 4 | 1 (1-180), 2 (181-660), 3 (661-2,400), 4 (2,401-12,400) |

Post-IFQ

For the post-IFQ index construction, seven factors were considered as possible influences on the proportion of trips that landed Scamp and Yellowmouth Grouper and on the catch rate of Scamp and Yellowmouth Grouper. Two additional factors were considered: (1) depth and (2) Scamp IFQ. Total Scamp IFQ allocation was assumed to be the sum of shallow-water and deep-water allocation available to a vessel on a fishing trip, where provided (note that some trips did not have allocation assigned).

| Factor | DF | Details |
|-----------|----|--|
| Year | 8 | 2010-2017 |
| Month | 12 | Jan, Feb, Mar, Apr, May, Jun, Jul, Aug, Sep, Oct, Nov, Dec |
| Area | 4 | 1 (areas 2-6), 2 (areas 7-8), 3 (areas 9-10), 4 (areas 11-21) |
| Crew | 3 | 1 (1-2 crew), 2 (3 crew), 3 (4-7 crew) |
| Away | 4 | 1 (1-4 days), 2 (5 days), 3 (6-7 days), 4 (8-14 days) |
| Scamp IFQ | 4 | 1 (NA), 2 (0-650 pounds), 3 (651-1,659 pounds), 4 (1,660-3,636 pounds), 5 (3,637-129,440 pounds) |
| Depth | 4 | 1 (0-120 m), 2 (121-175 m), 3 (176-200 m), 4 (201-700 m) |
| Hookhrs* | 4 | 1 (0.3-300), 2 (301-1,760), 3 (1,761-4,032), 4 (4,033-15,000) |

Annual Abundance Indices

Pre-IFQ

The final models for the binomial and lognormal components of the pre-IFQ index were:

$$\text{Proportion Positive} = \text{YEAR} + \text{AWAY} + \text{HOOKHRS}$$

$$\ln(\text{CPUE}) = \text{YEAR} + \text{AREA} + \text{AWAY} + \text{CREW} + \text{YEAR} * \text{AREA}$$

Nominal and standardized abundance indices for the pre-IFQ index are provided in Table 5.5 and Figure 5.3. Relative abundance has remained fairly stable throughout the time series, with peak predicted abundance in 1997 and the lowest abundance in 2000. As observed for both Red Grouper (SEDAR 42) and Gag Grouper (SEDAR 33), relative abundance declined rather sharply between 2005 and 2006, which is likely related to the severe 2005 red tide event that occurred on the West Florida Shelf (SEDAR33-DW-08).

Post-IFQ

The final models for the binomial and lognormal components of the post-IFQ index were:

$$\text{Proportion Positive} = \text{YEAR} + \text{AWAY} + \text{DEPTH} + \text{SCAMP IFQ} + \text{CREW} + \text{DEPTH} * \text{CREW}$$

$$\ln(\text{CPUE}) = \text{YEAR} + \text{AREA} + \text{AWAY} + \text{CREW} + \text{DEPTH} + \text{AREA} * \text{DEPTH}$$

Nominal and standardized abundance indices for the post-IFQ index are provided in Table 5.6 and Figure 5.4. Relative abundance has remained fairly stable throughout the time series, with peak abundance in 2016 and the lowest value in 2011.

5.4.3.2 Sampling Intensity and Time Series

Data were available from fisher-reported commercial logbooks for the years 1993-2017. Reporting to the coastal logbook program is mandatory for commercial fishers with federal fishing permits since 1993 and, therefore, is presumed to be a census of commercial Scamp and Yellowmouth Grouper fishing. Numbers of reported trips per year are provided in Table 5.5 for the pre-IFQ period and Table 5.6 for the post-IFQ period.

5.4.3.3 Size/Age Data

No size information is directly available in the commercial coastal logbook data set (reports were in pounds landed); however, size composition presumably matches that provided in Trip Interview Program data for commercial vertical line landings.

5.4.3.4 Catch Rates

Nominal and standardized CPUE (whole pounds landed per hook hour fished) are provided in Table 5.5 for the pre-IFQ period and Table 5.6 for the post-IFQ period.

5.4.3.5 Uncertainty and Measures of Precision

Coefficients of variation per year for the constructed index are provided in Table 5.5 for the pre-IFQ period and Table 5.6 for the post-IFQ period.

5.4.3.6 Comments on Adequacy for Assessment

Pre-IFQ index

The IWG found that the index was properly constructed and recommended its use in the assessment model. The diagnostics for both the binomial and lognormal models were satisfactory, suggesting that the assumptions behind each analysis were appropriate.

IFQ index

This index was not recommended for use in the assessment for several reasons. First, the diagnostics for the binomial model were poor, suggesting that the assumptions were not

appropriate for the data. Strong patterns in residuals were observed in all factors included in the model. Second, the IWG discussed concerns over using CFLP data to develop indices reflective of trends in relative abundance of the population of Scamp and Yellowmouth Grouper since the implementation of the IFQ program in 2010. Since CFLP data reflect landings only and do not include reliable data on discarded fish, any changes to discarding procedures since the implementation of the IFQ program could change the catchability and render trends not reflective of population abundance. Another potential limitation of the logbook data discussed was that the data collected on depth fished for a trip may be unreliable when reported. The logbook data forms contain a single line for entry of a single area and a single depth, which may not allow for accurate characterization of the various areas or depths fished during a single trip. Lastly, the implementation of the IFQ program in 2010 changed the way the fisheries operated by reducing the race to fish and striving for reduced discards. Fishermen were allowed more flexibility in their fishing practices (e.g., seasonal targeting or regional targeting depending upon species they have quota for or market prices). Most importantly, changes in catchability may mask true trends in population abundance.

5.4.4 Commercial Longline

Fishing effort data available for longline trips include the number of sets and number of hooks per set.

5.4.4.1 Methods of Estimation

Data Filtering Techniques

Data exclusions using CFLP data subset to longline trips for analyses (both pre- and post-IFQ) for Scamp and Yellowmouth Grouper were as follows:

- A. Longline trips fishing more the 24 longline sets per day were excluded.
- B. Trips that fell outside the 99.5th percentile were considered to represent mis-reported data or data entry errors and were excluded for the following variables: number of sets, number of hooks per set, the longline length, the number of days at sea (trip duration), and the number of crew members.

- C. Seasonal closures and regulatory closures have been employed to manage the commercial shallow-water grouper fishery. Closures in the pre-IFQ period were implemented on the following dates: November 15, 2004 – December 31, 2004; and October 10, 2005 – December 31, 2005. The dataset was restricted to time periods for which fishing on Scamp and Yellowmouth Grouper was allowed.
- D. No shallow-water grouper trip limits were reached between 2005 and 2008 in the pre-IFQ period.

The Stephens and MacCall (2004) multispecies approach was used to restrict the dataset to trips that likely encountered Scamp and Yellowmouth Grouper. This approach uses the species composition of each trip in a logistic regression of species presence/absence to infer if effort on that trip occurred in similar habitat occupied by Scamp and Yellowmouth Grouper. This approach was applied separately for the Eastern and Western GOM due to suspected differences in species compositions between regions. In applying the Stephens and MacCall (2004) approach, the species considered were limited to reef fish species. Lastly, any trips that may have caught exclusively Scamp and Yellowmouth Grouper were kept in the dataset and included in the analysis following previous decisions for other GOM grouper analyses.

For the pre-IFQ period, the percentage of trips catching Scamp and Yellowmouth Grouper was 19-45% before trip selection and 64-78% after trip selection for both the Eastern and Western GOM. For the post-IFQ period, the percentage of trips catching Scamp and Yellowmouth Grouper was 7-62% before trip selection and 77-87% after trip selection for both the Eastern and Western GOM.

Catch rate calculation

For the longline fishery, CPUE for each trip was defined as the whole weight of Scamp and Yellowmouth Grouper landed on a trip divided by the effort, where effort was the product of the number of longline sets and the number of hooks per set. For each trip, catch per unit effort was calculated as:

$\ln(\text{CPUE}) = \ln(\text{whole pounds of Scamp and Yellowmouth Grouper}) / (\text{number of longline sets} \times \text{number of hooks per set})$

Standardization

Given the high proportion of positive trips, a GLM assuming a binomial error distribution was deemed inappropriate. A GLM assuming a lognormal error distribution was used to examine the above factors for effects on Scamp and Yellowmouth Grouper CPUE. Factors that significantly affected CPUE were then identified using the GLM assuming a lognormal error distribution. The index was fit using the Proc Mixed procedure in SAS. All factors were modeled as fixed effects except two-way interaction terms containing YEAR that were modeled as random effects.

Submodel Variables

Pre-IFQ

For the pre-IFQ index construction, six factors were considered as possible influences on the proportion of trips that landed Scamp and Yellowmouth Grouper and on the catch rate of Scamp and Yellowmouth Grouper. In order to develop a well-balanced sample design, it was necessary to define categories within some of the factors examined:

| Factor | DF | Details |
|--------|----|---|
| Year | 17 | 1993-2009 |
| Month | 12 | Jan, Feb, Mar, Apr, May, Jun, Jul, Aug, Sep, Oct, Nov, Dec |
| Area | 3 | 1 (areas 1-4), 2 (area 5), 3 (area 6), 4 (areas 7-21) |
| Length | 3 | 1 (0.5-4), 2 (4.1-5), 3 (5.1-6), 4 (6.1-60) |
| Crew | 4 | 1 (1-2 crew), 2 (3 crew), 3 (4-6 crew) |
| Away | 4 | 1 (1-7 days), 2 (8-10 days), 3 (11-13 days), 4 (14-20 days) |

Post-IFQ

For the post-IFQ index construction, nine factors were considered as possible influences on the proportion of trips that landed Scamp and Yellowmouth Grouper and on the catch rate of Scamp and Yellowmouth Grouper. Three additional factors were considered: (1) depth, (2) season related to the closure inside 35 fathoms east of Cape San Blas, Florida, and (3) Scamp IFQ. Total

Scamp IFQ allocation was assumed to be the sum of shallow-water and deep-water allocation available to a vessel on a fishing trip, where provided (note that some trips did not have allocation assigned).

| Factor | DF | Details |
|--------|----|--|
| Year | 8 | 2010-2017 |
| Month | 12 | Jan, Feb, Mar, Apr, May, Jun, Jul, Aug, Sep, Oct, Nov, Dec |
| Area | 3 | 1 (areas 1-4), 2 (area 5), 3 (area 6-21) |
| Length | 3 | 1 (1-4), 2 (4.1-5), 3 (5.1-10) |
| Crew | 4 | 1 (1-2 crew), 2 (3 crew), 3 (4 crew), 4 (5-6 crew) |
| Away | 4 | 1 (1-9 days), 2 (10-12 days), 3 (13-14 days), 4 (15-21 days) |
| Depth | 4 | 1 (20-150 m), 2 (151-200 m), 3 (201-250 m), 4 (251-1,000 m) |
| Season | 2 | 1 (35 ftms), 2 (open) |
| IFQ | 4 | 1 (NA), 2 (0-1,765 pounds), 3 (1,766-5,145 pounds), 4 (5,146-11,311 pounds), 5 (11,312-171,562 pounds) |

Annual Abundance Indices

Pre-IFQ

The final model for the lognormal component of the pre-IFQ index was:

$$\ln(\text{CPUE}) = \text{YEAR} + \text{AWAY}$$

Nominal and standardized abundance indices for the pre-IFQ index are provided in Table 5.7 and Figure 5.5. Relative abundance remained fairly stable throughout the first half of the time series, with peak predicted abundance in 2009 and the lowest value in 1994. As observed above for the vertical line index, relative abundance declined rather sharply between 2005 and 2006, which is likely related to the severe 2005 red tide event that occurred on the West Florida Shelf (SEDAR33-DW-08).

Post-IFQ

The final model for the lognormal component of the post-IFQ index was:

$$\ln(\text{CPUE}) = \text{YEAR} + \text{DEPTH}$$

Nominal and standardized abundance indices for the post-IFQ index are provided in Table 5.8 and Figure 5.6. Relative abundance has remained fairly stable throughout the time series, with peak abundance in 2013 and the lowest value in 2014.

5.4.4.2 Sampling Intensity and Time Series

Data were available from fisher-reported commercial logbooks for the years 1993-2017. Reporting to the coastal logbook program is mandatory for commercial fishers with federal fishing permits since 1993 and, therefore, is presumed to be a census of commercial Scamp and Yellowmouth Grouper fishing. Numbers of reported trips per year are provided in Table 5.7 for the pre-IFQ period and Table 5.8 for the post-IFQ period.

5.4.4.3 Size/Age Data

No size information is directly available in the commercial coastal logbook data set (reports were in pounds landed); however, size composition presumably matches that provided in Trip Interview Program data for commercial longline landings.

5.4.4.4 Catch Rates

Nominal and standardized CPUE (whole pounds landed per hook fished) are provided in Table 5.7 for the pre-IFQ period and Table 5.8 for the post-IFQ period.

5.4.4.5 Uncertainty and Measures of Precision

Coefficients of variation per year for the constructed index are provided in Table 5.7 for the pre-IFQ period and Table 5.8 for the post-IFQ period.

5.4.4.6 Comments on Adequacy for Assessment

Pre-IFQ index

This index was not recommended for use in the assessment for a number of reasons. First, the diagnostics for the lognormal model were poor, suggesting that the assumptions were not appropriate for the data. Strong patterns in residuals were observed in all factors included in the model. Second, the IWG discussed concerns over using CFLP data to develop indices reflective of trends in relative abundance of the population of Scamp and Yellowmouth Grouper. In this case, discussions centered around the potential influence of regulations on the trend in the index.

For example, the large increase towards the end of the 2000s may be the result of regulations that went into place to reduce sea turtle bycatch (74 FR 53889).

Post-IFQ index

This index was not recommended for use in the assessment for a number of reasons. As discussed above for the commercial vertical line index, the IWG discussed concerns over using CFLP data to develop indices reflective of trends in relative abundance of the population of Scamp and Yellowmouth Grouper since the implementation of the IFQ program in 2010. Since CFLP data reflect landings only and do not include reliable data on discarded fish, any changes to discarding procedures since the implementation of the IFQ program could change the catchability and render trends not reflective of population abundance. Another potential limitation of the logbook data discussed was that the data collected on depth fished for a trip may be unreliable when reported. The logbook data forms contain a single line for entry of a single area and a single depth, which may not allow for accurate characterization of the various areas or depths fished during a single trip. Lastly, the implementation of the IFQ program in 2010 changed the way the fisheries operated by reducing the race to fish and striving for reduced discards. Fishermen were allowed more flexibility in their fishing practices (e.g., seasonal targeting or regional targeting depending upon species they have quota for or market prices). Most importantly, changes in catchability may mask true trends in population abundance.

5.4.5 Reef Fish Observer Program

There are concerns that catch-per-unit-effort (CPUE) abundance indices based on commercial fleet landings may not be valid after implementation of individual fishing quotas (IFQs) for selected grouper-snapper species in the GOM. For example, discards of Scamp and Yellowmouth Grouper were primarily smaller fish at or below the legal minimum length before IFQs were implemented in 2010; however, discards post-IFQ included larger legal-sized fish as well as sublegal fish (Smith et al. 2020). These findings suggest that a fundamental change may have occurred in the catch-effort relationship of legal-sized fish, the basis for commercial fleet CPUE indices of abundance, before and after implementation of IFQs. To address these concerns, a novel CPUE index was developed for the commercial fleet using data from the reef fish observer program. Observer observations of catch include both kept and discarded fish, and

are thus not directly impacted by changes in management regulations (e.g., minimum size, catch quotas, etc.).

5.4.5.1 Methods of Estimation

Reef fish observer data for vertical line gear have much in common with fishery-independent surveys utilizing fishing gears, including: latitude-longitude coordinates were recorded at each specific fishing location, catches were recorded for individual species, and lengths were recorded for individual fish (Scott-Denton et al. 2011). A probability survey approach was thus used for estimation of the reef fish observer CPUE index. The spatial sample frame was delineated as 500x500 m grid cells (i.e., sample units) encompassing the full range of Scamp/Yellowmouth Grouper observed depths (20-150 m) in the Western and Eastern GOM. Analysis techniques were developed to account for varying gear characteristics (e.g., hook types, hook sizes, etc.) and varying effort (e.g., number of lines, fishing time at a location, etc.) in the estimation procedure.

Data Filtering

Initial filtering steps restricted data to vertical line gears, and excluded observations with missing location information (i.e., latitude-longitude). This enabled assignment of observations at specific fishing locations to a unique 500x500 m grid cell with associated depth information, and subsequent restriction of observations to the observed Scamp depth range of 20-150 m.

Scamp/Yellowmouth Grouper length frequency distributions were found to differ with respect to hook type (j-hooks vs. circle hooks) as well as hook size. Data were subsequently filtered to include circle hooks, which accounted for over 90% of observations, for two distinct hook size categories (medium and large) based on a combination of hook length and hook point-to-shaft length measurements taken by observers.

Species co-occurrence analysis following methods of Mackenzie et al. (2006) was used to identify valid Scamp/Yellowmouth Grouper sample units, i.e., sample units with a non-zero probability of catching Scamp: fishing samples were included if either Scamp/Yellowmouth Grouper or a positively-associated species were captured.

Analyses identified line-hours as the most appropriate effort variable for CPUE estimation. High values of line-hours exceeding the 99th percentile were excluded as outliers.

Standardization

Line-hours were standardized for the two hook size categories using the fishing power approach (Robson 1966), which estimates the relative catchability (q) between two gears, and then converts effort of one gear in terms of the second gear. Estimation of fishing power was carried out using a compound pdf generalized linear model (GLM), which analyzed presence-absence using a logistic regression model and catch-when-present using a gamma pdf GLM. Effort for large circle hooks was converted to that of medium circle hooks, and the data were pooled for estimating the CPUE index.

5.4.5.2 Sampling Intensity and Time Series

After data filtering, the final sample size used in this index was over 14,000 and is shown in Table 5.9. While the RFOP covers about 2 percent of the vertical line vessels in the GOM (SEDAR68-DW-17), this index was developed on sets which reflect a substantial sample size.

5.4.5.3 Size/Age Data

The commercial Reef Fish Observer Program (RFOP) provides extensive information on fish hauled onboard a vessel including: condition (alive, dead, barotrauma), disposition (kept, discarded dead, discarded alive, etc.), whether the fish was vented before release, length, and weight.

5.4.5.4 Catch Rates

Annual estimates of Scamp/Yellowmouth Grouper CPUE and associated variance were estimated using a Hurwitz-Thompson ratio-of-means estimator for a stratified sample frame (Lohr 2010). Analysis of subregion (West vs. East GOM) and depth stratification variables identified a depth-only scheme with three levels of depth—20-50m, 50-75m, and 75-150m—as the most effective with respect to spatial partitioning of sample variance for CPUE. Spatial strata weighting controlled for potential bias of stock-wide CPUE estimates due to disproportionate sampling in relation to depth strata.

Estimates of the reef fish observer abundance index for GOM Scamp/Yellowmouth Grouper for 2007-2018 are provided in Table 5.9 for the commercial vertical line fleet. The standardized index (scaled to mean CPUE for 2007-2018) time-series is graphed in Fig. 5.7, which also shows

the 95% confidence intervals. The estimates suggest that Scamp/Yellowmouth Grouper abundance was relatively stable in the GOM during 2007-2018, but indicate generally lower abundance during 2010-2011 compared to other years.

5.4.5.5 Uncertainty and Measures of Precision

Coefficients of variation per year for the constructed index are provided in Table 5.9.

5.4.5.6 Comments on Adequacy for Assessment

The RFOP index was deemed adequate for use in the assessment by the IWG. This decision was the result of several factors. Primarily, the index provides valuable fishery-dependent data that includes both landed fish and discards, unique to this dataset. Furthermore, Scamp and Yellowmouth Grouper are rarely a primarily targeted species and the IWG considered this index to be potentially more representative of population abundance rather than effort or response to management. This dataset also fills in later years of the assessment where other fishery-dependent data (vertical line logbook) were not used due to the implementation of IFQs. Considerable effort went into developing this index in terms of data selection, model development and evaluation and stratification of effort in space to. As such, this novel index was approved for use and methods evaluated thoroughly for this and potentially, future assessments.

5.5 OTHER DATA SOURCES CONSIDERED DURING THE DW

Additional data sources were discussed during the IWG webinar for the potential to support indices of abundance, and some of these were discarded after review. These were the reef fish visual survey in the FL Keys and Tortugas, the SEAMAP stand-alone video survey, and the Recreational Marine Recreational Information program survey. Reasons for not recommending are given in Tables 5.1 and 5.2. An additional, emerging, electronic monitoring dataset of the commercial vertical line fishery was presented by the Mote Marine Laboratory; however, data were limited and didn't have consideration as a potential data set. However, this data set is to be expected to be valuable to future assessments as data continue to be collected.

5.6 CONSENSUS RECOMMENDATIONS AND SURVEY EVALUATIONS

The DW recommended one fishery-independent (combined stereo-video) and three fishery dependent indices (headboat logbook index, commercial vertical line logbook, and reef fish observer program) for potential use in the Scamp and Yellowmouth Grouper stock assessment.

Pearson correlations between indices are presented in Table 5.10. All recommended indices are compared graphically in Figure 5.8 with standardized index values and CVs for each in Table 5.11.

5.7 LITERATURE CITED

- Campbell, R.A. 2004. CPUE standardization and the construction of indices of stock abundance in a spatially varying fishery using general linear models. *Fisheries Research* 70: 209-227.
- Littell, R.C., P.R. Henry and C.B. Ammerman. 1998. Statistical analysis of repeated measures data using SAS procedures. *J. Anim. Sci.* 76:1216-1231.
- Lo, N.C., L.D. Jacobson, J.L. Squire. 1992. Indices of relative abundance from fish spotter data based on delta-lognormal models. *Can. J. Fish. Aquat. Sci.* 49:2515–2526.
- Lohr, S.L. 2010. *Sampling: design and analysis*, 2nd ed. Boston: Brooks/Cole.
- Mackenzie, D.I., J.D. Nichols, J.A. Royle, K.H. Pollock, L. Bailey, J.E. Hines. 2006. *Occupancy estimation and modeling: inferring patterns and dynamics of species occurrence*. Academic Press.
- Robson, D.S. 1966. Estimation of the relative fishing power of individual ships. *ICNAF Res. Bull.* 3:5-15.
- Scott-Denton, E., P.F. Cryer, J.P. Gocke, Harrelson, M.R., Kinsella, D.L., Pulver, J.R., Smith, R.C., Williams, J. 2011. Descriptions of the U.S. Gulf of Mexico reef fish bottom longline and vertical line fisheries based on observer data. *Marine Fisheries Review* 73(2):1-26.
- Smith, S.G., S. Martinez, K.J. McCarthy. 2020. CPUE Expansion Estimation for Commercial Discards of Gulf of Mexico Scamp and Yellowmouth Grouper. SEDAR68-DW-30. SEDAR, North Charleston, SC. 27 pp.
- Stephens, A. and A. MacCall. 2004. A multispecies approach to subsetting logbook data for purposes of estimating CPUE. *Fish. Res.* 70:299–310.
- Ye, Y., and D. Dennis. 2009. How reliable are abundance indices derived from commercial catch-effort standardization. *Can. J. Fish. Aqu. Sci.* 66:1169-1178.

5.8 Tables

Table 5.1. Table of the data sources considered for indices of abundance.

| Fishery Type | Data Source | Area | Yrs | Units | Standardization Method | Issues | Use? |
|--------------|------------------------------|-------------------|-----------|------------------------|------------------------|---|------|
| Recreational | Headboat | TX-FL | 1986-2017 | N kept/ angler*hour | Delta-GLM | Fishery-dependent, logbook-reported, landings only | Yes |
| Recreational | MRIP | TX-FL | 1986-2017 | Not calculated | No model fit | Limited data, low proportion positive | No |
| Commercial | Vertical line, Pre-IFQ | TX-FL | 1993-2009 | Pounds/hook* hour | Delta-GLM | Fishery-dependent, logbook reported, landings only | Yes |
| Commercial | Vertical line, Post-IFQ | TX-FL | 2010-2017 | Pounds/hook* hour | Delta-GLM | Fishery-dependent, logbook reported, landings only. Post-IFQ management changes effects on fishery behavior | No |
| Commercial | Longline, Pre-IFQ | TX-FL | 1993-2009 | Pounds/hooks | Lognormal-GLM | Fishery-dependent, logbook reported, landings only. Low catch rate for species. | No |
| Commercial | Longline, Post-IFQ | TX-FL | 2010-2017 | Pounds/hooks | Lognormal-GLM | Fishery-dependent, logbook reported, landings only. Low catch rate for species. | No |
| Commercial | Reef fish observer program | TX-FL | 2007-2018 | N/line*hour | Design based model | Fishery-dependent | Yes |
| Independent | Reef-fish visual survey | FL Keys, Tortugas | 1999-2018 | N/visual cylinder | Strata-weighted | Small area of survey not likely fully representative of recruitment dynamics of GOM | No |
| Independent | Combined stereo-video survey | TX-FL | 1993-2018 | MaxN | Negative Binomial-GLM | Changing spatial extent through time | Yes |
| Independent | SEAMAP video survey | TX-FL | 1993-2018 | MaxN | Delta-GLM | Subset of combined video survey, limited depth range | No |

Table 5.2. Table of the pros and cons for each data set considered at the Data Workshop.Fishery-independent indicesCombined stereo-video index (*Recommended for use*)

Pros:

- Fishery-independent and stratified-random
- GOM-wide coverage
- No size selectivity of gear
- Size measurements provided for species of interest
- Index weighted to account for spatial and habitat variation by survey

Cons

- Shifts in coverage through years as surveys are added
- Differences in mapping/habitat description by survey

SEAMAP stereo-video survey (*Not recommended for use*)

Pros:

- Fishery-independent and stratified-random
- GOM-wide coverage
- No size selectivity of gear
- Size measurements provided for species of interest
- Longest time series for fishery-independent surveys

Cons

- Limited to deep, high relief habitats
- Subset of the combined video index that includes greater habitat and spatial coverage

Reef-fish visual survey (*Not recommended for use*)

Pros:

- Fishery-independent
- Provides data on smaller fish and recruits to nearshore
- Provides data on reef-building coral

Cons:

- Gaps in years of sampling
- Area not likely representative of entire GOM recruitment dynamics
- Low Scamp counts with high CVs of annual estimates

Fishery-dependent indicesRecreational headboat logbook (*Recommended for use*)

Pros:

- Complete census

- Covers the entire management area
- Large sample size
- Generally non-targeted for focal species, which should minimize changes in catchability relative to fishery dependent indices that target specific species
- Update to methods to follow standardized South Atlantic protocols in relation to trip selection and data processing

Cons:

- Fishery dependent (i.e., potentially affected by regulations on both the focal species and other species, targeting, hyperdepletion, hyperstability)
- No information on discard rates
- Catchability may vary over time or with abundance
- Effective effort is difficult to identify

Commercial logbook-vertical line (*Pre-IFQ recommended for use, Post-IFQ not recommended*)

Pros:

- Complete census
- Covers the entire management area
- Large sample size
- Generally non-targeted for focal species, which should minimize changes in catchability relative to fishery dependent indices that target specific species
- Relatively high frequency of trips with Scamp after trip selection model
- Pre-IFQ management consistent enough that variance in effort is similar to baseline fishery dependent data

Cons:

- Fishery-dependent (i.e., potentially affected by regulations on both the focal species and other species, targeting, hyperdepletion, hyperstability)
- No information on discard rates
- Catchability may vary over time or with abundance
- Effective effort is difficult to identify
- Post-IFQ changes in annual catchability may mask trends in population abundance

Commercial logbook-longline (*Pre-IFQ and Post-IFQ not recommended*)

Pros:

- Complete census
- Covers the entire management area
- Large sample size
- Generally non-targeted for focal species, which should minimize changes in catchability relative to fishery dependent indices that target specific species
- Pre-IFQ management consistent enough that variance in effort is similar to baseline fishery dependent data

Cons:

- Fishery-dependent (i.e., potentially affected by regulations on both the focal species and other species, targeting, hyperdepletion, hyperstability)
- Low catch rates for Scamp in the fishery
- Poor model fit and diagnostics
- No information on discard rates
- Catchability may vary over time or with abundance
- Effective effort is difficult to identify

Reef fish observer program

Pros:

- Covers the entire management area
- Large sample size
- Observer data includes kept fish and discards and therefore catch is less affected by regulations
- Used vertical line gear with high frequency of Scamp caught
- Analytical approach accounts for gear and effort variation
- Spatial strata weighting adjusts for bias in sampling through the spatial extent of the stock

Cons:

- Fishery-dependent (i.e., potentially affected by regulations, targeting, hyperdepletion, hyperstability)
- Variation in gear and effort by locations adjusted for 500m-squared grid cells
- Assumes sampling within a stratum representative of habitat in that stratum
- Catchability may vary over time or with abundance

Table 5.3. Number of stations sampled (N) combined across surveys and year, proportion of positive sets, standardized index, standardized nominal index, and CV for the annual Combined video index of the Gulf of Mexico.

| Year | N | Prop present | Std. Index | Std. Nominal | CV | Lower 95% CI | Upper 95% CI |
|------|-----|--------------|------------|--------------|-------|--------------|--------------|
| 1993 | 180 | 0.217 | 0.870 | 0.952 | 0.173 | 0.650 | 1.091 |
| 1994 | 160 | 0.150 | 0.497 | 0.526 | 0.235 | 0.326 | 0.668 |
| 1995 | 125 | 0.224 | 0.565 | 0.627 | 0.255 | 0.354 | 0.776 |
| 1996 | 312 | 0.218 | 0.778 | 0.753 | 0.175 | 0.579 | 0.977 |
| 1997 | 296 | 0.236 | 0.645 | 0.884 | 0.134 | 0.518 | 0.773 |
| 2002 | 260 | 0.419 | 1.758 | 1.841 | 0.142 | 1.393 | 2.123 |
| 2004 | 200 | 0.305 | 1.990 | 2.246 | 0.175 | 1.479 | 2.501 |
| 2005 | 414 | 0.290 | 1.499 | 1.628 | 0.134 | 1.205 | 1.793 |
| 2006 | 545 | 0.169 | 0.941 | 0.878 | 0.169 | 0.709 | 1.174 |
| 2007 | 585 | 0.287 | 1.532 | 1.435 | 0.121 | 1.260 | 1.803 |
| 2008 | 429 | 0.273 | 1.131 | 1.150 | 0.147 | 0.887 | 1.376 |
| 2009 | 555 | 0.265 | 1.228 | 1.193 | 0.127 | 0.999 | 1.458 |
| 2010 | 640 | 0.239 | 1.071 | 1.062 | 0.124 | 0.876 | 1.267 |
| 2011 | 834 | 0.254 | 1.182 | 1.242 | 0.097 | 1.013 | 1.351 |
| 2012 | 872 | 0.182 | 0.673 | 0.727 | 0.120 | 0.555 | 0.791 |
| 2013 | 594 | 0.215 | 0.729 | 0.761 | 0.118 | 0.602 | 0.856 |
| 2014 | 799 | 0.208 | 0.876 | 0.830 | 0.117 | 0.725 | 1.027 |
| 2015 | 603 | 0.226 | 0.938 | 0.841 | 0.132 | 0.757 | 1.119 |
| 2016 | 750 | 0.245 | 0.790 | 0.869 | 0.102 | 0.672 | 0.907 |
| 2017 | 738 | 0.225 | 0.751 | 0.801 | 0.116 | 0.624 | 0.878 |
| 2018 | 642 | 0.181 | 0.555 | 0.642 | 0.108 | 0.467 | 0.642 |

Table 5.4. Numbers (N) of total and positive trips, proportion of positive trips (PPT), relative nominal CPUE, and standardized abundance index statistics for Scamp and Yellowmouth Grouper in the U.S. Gulf of Mexico NMFS Southeast Region Headboat Survey index.

| Year | N | Positive N | PPT | Relative Nominal CPUE | Relative Index | Lower 95% CI | Upper 95% CI | CV |
|------|------|------------|-------|-----------------------|----------------|--------------|--------------|-------|
| 1986 | 240 | 144 | 0.600 | 1.826 | 2.015 | 1.534 | 2.648 | 0.137 |
| 1987 | 317 | 144 | 0.454 | 1.005 | 1.384 | 1.046 | 1.833 | 0.141 |
| 1988 | 365 | 163 | 0.447 | 1.248 | 1.477 | 1.137 | 1.919 | 0.131 |
| 1989 | 352 | 90 | 0.256 | 0.667 | 0.817 | 0.624 | 1.070 | 0.135 |
| 1990 | 367 | 120 | 0.327 | 0.964 | 1.172 | 0.899 | 1.529 | 0.133 |
| 1991 | 393 | 100 | 0.254 | 0.734 | 0.979 | 0.744 | 1.289 | 0.138 |
| 1992 | 471 | 107 | 0.227 | 0.582 | 0.708 | 0.542 | 0.923 | 0.133 |
| 1993 | 411 | 102 | 0.248 | 0.699 | 0.745 | 0.571 | 0.972 | 0.134 |
| 1994 | 506 | 155 | 0.306 | 0.877 | 0.863 | 0.662 | 1.125 | 0.133 |
| 1995 | 493 | 165 | 0.335 | 0.986 | 1.208 | 0.923 | 1.583 | 0.136 |
| 1996 | 385 | 99 | 0.257 | 0.793 | 0.846 | 0.639 | 1.120 | 0.141 |
| 1997 | 445 | 108 | 0.243 | 0.743 | 0.764 | 0.562 | 1.038 | 0.154 |
| 1998 | 336 | 101 | 0.301 | 0.816 | 0.967 | 0.721 | 1.298 | 0.148 |
| 1999 | 268 | 49 | 0.183 | 0.665 | 0.679 | 0.491 | 0.938 | 0.163 |
| 2000 | 389 | 98 | 0.252 | 0.666 | 0.806 | 0.600 | 1.083 | 0.148 |
| 2001 | 516 | 91 | 0.176 | 0.687 | 0.667 | 0.489 | 0.911 | 0.156 |
| 2002 | 476 | 125 | 0.263 | 1.223 | 1.005 | 0.756 | 1.338 | 0.144 |
| 2003 | 492 | 108 | 0.220 | 1.234 | 0.791 | 0.579 | 1.082 | 0.157 |
| 2004 | 317 | 121 | 0.382 | 1.520 | 1.329 | 1.006 | 1.757 | 0.140 |
| 2005 | 359 | 141 | 0.393 | 1.427 | 1.287 | 0.972 | 1.704 | 0.141 |
| 2006 | 349 | 86 | 0.246 | 1.286 | 0.943 | 0.687 | 1.294 | 0.159 |
| 2007 | 377 | 146 | 0.387 | 1.643 | 1.546 | 1.126 | 2.124 | 0.160 |
| 2008 | 618 | 223 | 0.361 | 1.563 | 1.440 | 1.075 | 1.929 | 0.147 |
| 2009 | 716 | 198 | 0.277 | 1.066 | 0.912 | 0.685 | 1.214 | 0.144 |
| 2010 | 286 | 66 | 0.231 | 0.832 | 0.708 | 0.505 | 0.994 | 0.171 |
| 2011 | 438 | 230 | 0.525 | 2.068 | 1.757 | 1.301 | 2.372 | 0.151 |
| 2012 | 680 | 236 | 0.347 | 1.223 | 1.066 | 0.813 | 1.397 | 0.136 |
| 2013 | 826 | 197 | 0.238 | 0.663 | 0.676 | 0.490 | 0.932 | 0.162 |
| 2014 | 934 | 228 | 0.244 | 0.658 | 0.733 | 0.550 | 0.977 | 0.144 |
| 2015 | 957 | 280 | 0.293 | 0.747 | 0.785 | 0.589 | 1.045 | 0.144 |
| 2016 | 1080 | 197 | 0.182 | 0.448 | 0.461 | 0.348 | 0.611 | 0.141 |
| 2017 | 870 | 156 | 0.179 | 0.441 | 0.460 | 0.336 | 0.629 | 0.158 |

Table 5.5. Numbers (N) of total and positive trips, proportion of positive trips (PPT), relative nominal CPUE, and standardized abundance index statistics for Scamp and Yellowmouth Grouper in the U.S. GOM for the Pre-IFQ vertical line index.

| Year | N | Positive N | PPT | Relative Nominal CPUE | Relative Index | Lower 95% CI | Upper 95% CI | CV |
|------|------|------------|-------|-----------------------|----------------|--------------|--------------|-------|
| 1993 | 1006 | 645 | 0.641 | 0.870 | 0.986 | 0.591 | 1.643 | 0.260 |
| 1994 | 1239 | 735 | 0.593 | 0.857 | 0.849 | 0.511 | 1.410 | 0.258 |
| 1995 | 1380 | 867 | 0.628 | 1.104 | 1.254 | 0.755 | 2.082 | 0.258 |
| 1996 | 1475 | 898 | 0.609 | 0.978 | 1.048 | 0.631 | 1.741 | 0.258 |
| 1997 | 1876 | 1238 | 0.660 | 1.099 | 1.314 | 0.792 | 2.179 | 0.257 |
| 1998 | 1874 | 1111 | 0.593 | 0.837 | 0.991 | 0.598 | 1.644 | 0.257 |
| 1999 | 2131 | 1283 | 0.602 | 0.860 | 0.954 | 0.576 | 1.581 | 0.257 |
| 2000 | 1643 | 930 | 0.566 | 0.538 | 0.634 | 0.382 | 1.052 | 0.257 |
| 2001 | 1818 | 1082 | 0.595 | 1.095 | 1.005 | 0.606 | 1.666 | 0.257 |
| 2002 | 2166 | 1378 | 0.636 | 0.923 | 0.991 | 0.598 | 1.642 | 0.257 |
| 2003 | 2335 | 1602 | 0.686 | 1.007 | 0.948 | 0.571 | 1.571 | 0.257 |
| 2004 | 1996 | 1411 | 0.707 | 1.270 | 1.081 | 0.652 | 1.795 | 0.257 |
| 2005 | 1629 | 1148 | 0.705 | 1.299 | 1.302 | 0.784 | 2.162 | 0.258 |
| 2006 | 1561 | 1026 | 0.657 | 1.116 | 0.847 | 0.510 | 1.405 | 0.257 |
| 2007 | 1242 | 953 | 0.767 | 1.325 | 1.001 | 0.603 | 1.662 | 0.257 |
| 2008 | 1274 | 978 | 0.768 | 0.899 | 0.966 | 0.581 | 1.604 | 0.258 |
| 2009 | 1404 | 1075 | 0.766 | 0.921 | 0.829 | 0.499 | 1.376 | 0.258 |

Table 5.6. Numbers (N) of total and positive trips, proportion of positive trips (PPT), relative nominal CPUE, and standardized abundance index statistics for Scamp and Yellowmouth Grouper in the U.S. GOM for the Post-IFQ vertical line index.

| Year | N | Positive N | PPT | Relative Nominal CPUE | Relative Index | Lower 95% CI | Upper 95% CI | CV |
|------|------|------------|-------|-----------------------|----------------|--------------|--------------|-------|
| 2010 | 924 | 673 | 0.728 | 0.555 | 0.956 | 0.811 | 1.126 | 0.082 |
| 2011 | 969 | 698 | 0.720 | 0.345 | 0.632 | 0.535 | 0.747 | 0.084 |
| 2012 | 1256 | 948 | 0.755 | 1.154 | 1.149 | 0.995 | 1.327 | 0.072 |
| 2013 | 1047 | 787 | 0.752 | 2.187 | 1.183 | 1.014 | 1.381 | 0.077 |
| 2014 | 1052 | 778 | 0.740 | 0.561 | 0.903 | 0.767 | 1.064 | 0.082 |
| 2015 | 972 | 718 | 0.739 | 1.640 | 1.018 | 0.864 | 1.199 | 0.082 |
| 2016 | 1150 | 881 | 0.766 | 0.890 | 1.274 | 1.082 | 1.501 | 0.082 |
| 2017 | 959 | 673 | 0.702 | 0.669 | 0.885 | 0.744 | 1.051 | 0.086 |

Table 5.7. Numbers (N) of total trips, relative nominal CPUE, and standardized abundance index statistics for Scamp and Yellowmouth Grouper in the U.S. GOM for the Pre-IFQ longline index.

| Year | N | Relative Nominal CPUE | Relative Index | Lower 95% CI | Upper 95% CI | CV |
|------|-----|-----------------------|----------------|--------------|--------------|-------|
| 1993 | 362 | 0.521 | 0.677 | 0.579 | 0.790 | 0.078 |
| 1994 | 378 | 0.571 | 0.582 | 0.498 | 0.681 | 0.078 |
| 1995 | 361 | 0.781 | 0.667 | 0.571 | 0.779 | 0.078 |
| 1996 | 366 | 0.517 | 0.696 | 0.597 | 0.812 | 0.077 |
| 1997 | 494 | 0.799 | 0.885 | 0.778 | 1.006 | 0.064 |
| 1998 | 519 | 1.679 | 0.935 | 0.825 | 1.059 | 0.062 |
| 1999 | 552 | 0.954 | 0.755 | 0.666 | 0.855 | 0.062 |
| 2000 | 473 | 0.669 | 0.654 | 0.570 | 0.750 | 0.069 |
| 2001 | 501 | 0.908 | 0.893 | 0.786 | 1.014 | 0.064 |
| 2002 | 474 | 1.128 | 1.014 | 0.891 | 1.153 | 0.064 |
| 2003 | 574 | 0.988 | 1.074 | 0.956 | 1.208 | 0.058 |
| 2004 | 592 | 1.108 | 1.215 | 1.085 | 1.362 | 0.057 |
| 2005 | 545 | 1.501 | 1.559 | 1.388 | 1.751 | 0.058 |
| 2006 | 605 | 0.778 | 0.858 | 0.763 | 0.965 | 0.059 |
| 2007 | 418 | 1.055 | 1.098 | 0.959 | 1.257 | 0.068 |
| 2008 | 469 | 1.340 | 1.376 | 1.214 | 1.560 | 0.063 |
| 2009 | 226 | 1.703 | 2.062 | 1.734 | 2.453 | 0.087 |

Table 5.8. Numbers (N) of total trips, relative nominal CPUE, and standardized abundance index statistics for Scamp and Yellowmouth Grouper in the U.S. GOM for the Post-IFQ longline index.

| Year | N | Relative Nominal CPUE | Relative Index | Lower 95% CI | Upper 95% CI | CV |
|------|-----|-----------------------|----------------|--------------|--------------|-------|
| 2010 | 184 | 1.237 | 1.181 | 1.004 | 1.389 | 0.081 |
| 2011 | 281 | 0.998 | 0.790 | 0.688 | 0.908 | 0.070 |
| 2012 | 246 | 1.507 | 1.242 | 1.079 | 1.429 | 0.070 |
| 2013 | 255 | 1.447 | 1.329 | 1.159 | 1.524 | 0.069 |
| 2014 | 299 | 0.484 | 0.720 | 0.628 | 0.825 | 0.069 |
| 2015 | 371 | 0.774 | 0.908 | 0.805 | 1.023 | 0.060 |
| 2016 | 451 | 1.045 | 1.101 | 0.989 | 1.225 | 0.054 |
| 2017 | 415 | 0.508 | 0.729 | 0.649 | 0.820 | 0.059 |

Table 5.9. Reef fish observer CPUE index time-series for GOM Scamp/Yellowmouth Grouper for the commercial vertical line fleet. Effort units are standardized line-hours. The relative index was scaled to mean CPUE for 2007-2018.

| Year | n | Mean Catch | Mean Effort | Nominal CPUE | Relative Index | CV |
|------|------|------------|-------------|--------------|----------------|-------|
| 2007 | 698 | 1.984 | 0.264 | 0.133 | 0.923 | 0.103 |
| 2008 | 499 | 2.333 | 0.335 | 0.144 | 0.998 | 0.178 |
| 2009 | 433 | 2.047 | 0.289 | 0.141 | 0.979 | 0.187 |
| 2010 | 804 | 1.763 | 0.173 | 0.098 | 0.682 | 0.200 |
| 2011 | 1431 | 1.898 | 0.164 | 0.087 | 0.602 | 0.130 |
| 2012 | 3638 | 1.844 | 0.320 | 0.174 | 1.206 | 0.059 |
| 2013 | 1192 | 1.682 | 0.260 | 0.154 | 1.072 | 0.220 |
| 2014 | 1167 | 1.650 | 0.205 | 0.124 | 0.864 | 0.095 |
| 2015 | 2251 | 1.690 | 0.278 | 0.164 | 1.142 | 0.074 |
| 2016 | 1476 | 1.723 | 0.310 | 0.180 | 1.251 | 0.098 |
| 2017 | 769 | 1.707 | 0.262 | 0.153 | 1.066 | 0.126 |
| 2018 | 384 | 2.094 | 0.366 | 0.175 | 1.215 | 0.123 |

Table 5.10. Pearson correlation values for indices recommended for use.

| | Headboat logbook | Combined stereo- video | Reef fish observer | Vertical Line Logbook (Pre-IFQ) |
|------------------------------------|---------------------|------------------------------|-----------------------|--|
| Headboat logbook | 1 | | | |
| Combined stereo- video | 0.524 | 1 | | |
| Reef fish observer | 0.482 | 0.604 | 1 | |
| Vertical Line Logbook (Pre-IFQ) | 0.282 | 0.023 | 0.454 | 1 |

Table 5.11. Scamp and Yellowmouth Grouper standardized indices of abundance and annual CVs recommended for potential use in the stock assessment.

| year | Standardized Index Values | | | | CVs | | | |
|------|---------------------------|------------------|-----------------------|--------------------|-----------------------|------------------|-----------------------|--------------------|
| | Combined stereo-video | Headboat Logbook | Vertical Line Logbook | Reef fish observer | Combined stereo-video | Headboat Logbook | Vertical Line Logbook | Reef fish observer |
| 1986 | | 2.02 | | | | 0.137 | | |
| 1987 | | 1.38 | | | | 0.141 | | |
| 1988 | | 1.48 | | | | 0.131 | | |
| 1989 | | 0.82 | | | | 0.135 | | |
| 1990 | | 1.17 | | | | 0.133 | | |
| 1991 | | 0.98 | | | | 0.138 | | |
| 1992 | | 0.71 | | | | 0.133 | | |
| 1993 | 0.87 | 0.75 | 0.99 | | 0.173 | 0.134 | 0.26 | |
| 1994 | 0.50 | 0.86 | 0.85 | | 0.235 | 0.133 | 0.258 | |
| 1995 | 0.57 | 1.21 | 1.25 | | 0.255 | 0.136 | 0.258 | |
| 1996 | 0.78 | 0.85 | 1.05 | | 0.175 | 0.141 | 0.258 | |
| 1997 | 0.65 | 0.76 | 1.31 | | 0.134 | 0.154 | 0.257 | |
| 1998 | | 0.97 | 0.99 | | | 0.148 | 0.257 | |
| 1999 | | 0.68 | 0.95 | | | 0.163 | 0.257 | |
| 2000 | | 0.81 | 0.63 | | | 0.148 | 0.257 | |
| 2001 | | 0.67 | 1.01 | | | 0.156 | 0.257 | |
| 2002 | 1.76 | 1.01 | 0.99 | | 0.142 | 0.144 | 0.257 | |
| 2003 | | 0.79 | 0.95 | | | 0.157 | 0.257 | |
| 2004 | 1.99 | 1.33 | 1.08 | | 0.175 | 0.14 | 0.257 | |
| 2005 | 1.50 | 1.29 | 1.30 | | 0.134 | 0.141 | 0.258 | |
| 2006 | 0.94 | 0.94 | 0.85 | | 0.169 | 0.159 | 0.257 | |
| 2007 | 1.53 | 1.55 | 1.00 | 0.92 | 0.121 | 0.16 | 0.257 | 0.103 |
| 2008 | 1.13 | 1.44 | 0.97 | 1.00 | 0.147 | 0.147 | 0.258 | 0.178 |
| 2009 | 1.23 | 0.91 | 0.83 | 0.98 | 0.127 | 0.144 | 0.258 | 0.187 |
| 2010 | 1.07 | 0.71 | | 0.68 | 0.124 | 0.171 | | 0.2 |
| 2011 | 1.18 | 1.76 | | 0.60 | 0.097 | 0.151 | | 0.13 |
| 2012 | 0.67 | 1.07 | | 1.21 | 0.12 | 0.136 | | 0.059 |
| 2013 | 0.73 | 0.68 | | 1.07 | 0.118 | 0.162 | | 0.22 |
| 2014 | 0.88 | 0.73 | | 0.86 | 0.117 | 0.144 | | 0.095 |
| 2015 | 0.94 | 0.78 | | 1.14 | 0.132 | 0.144 | | 0.074 |
| 2016 | 0.79 | 0.46 | | 1.25 | 0.102 | 0.141 | | 0.098 |
| 2017 | 0.75 | 0.46 | | 1.07 | 0.116 | 0.158 | | 0.126 |
| 2018 | 0.55 | | | 1.21 | 0.108 | | | 0.123 |

5.8 FIGURES

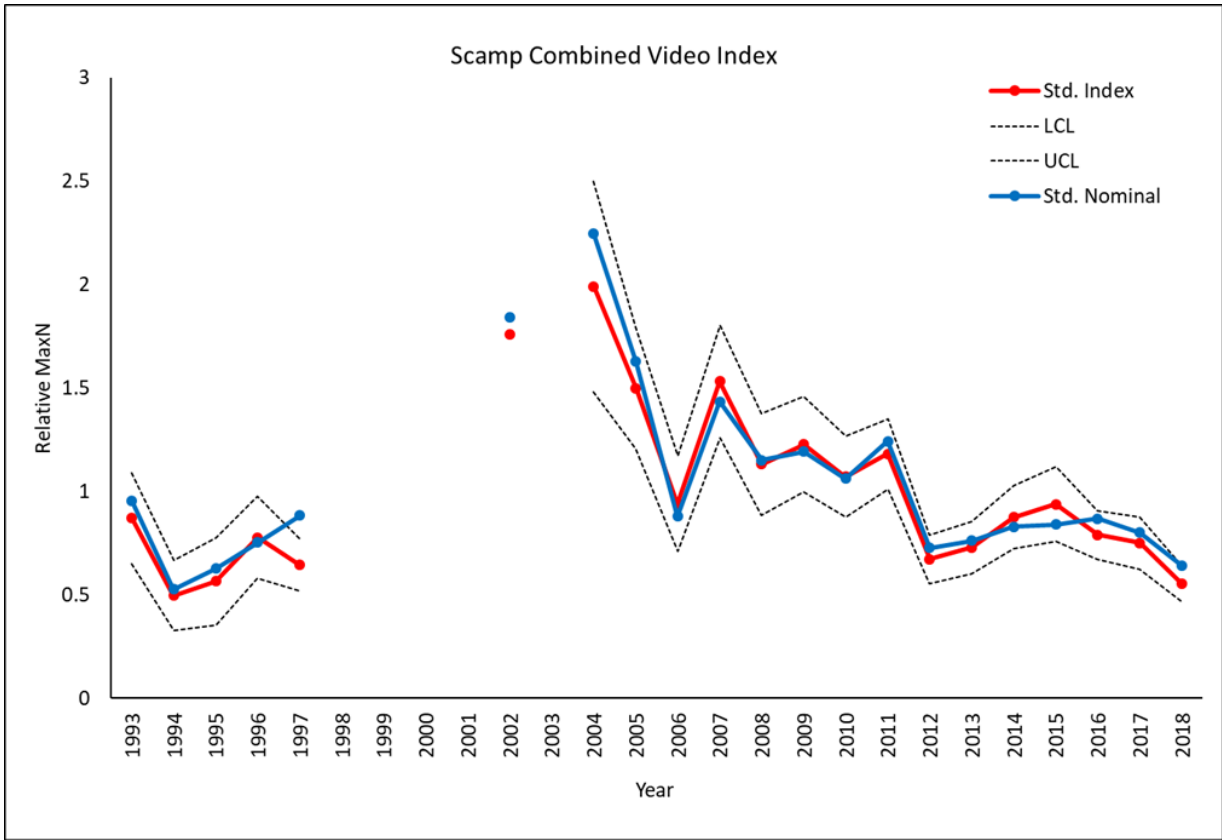

Figure 5.1. Standardized index (solid red line) with 2.5% and 97.5% confidence intervals (black dotted lines) and nominal index (solid blue line) for Scamp CPUE (MaxN) using the integrated GOM stereo-video data. This index was recommended for use.

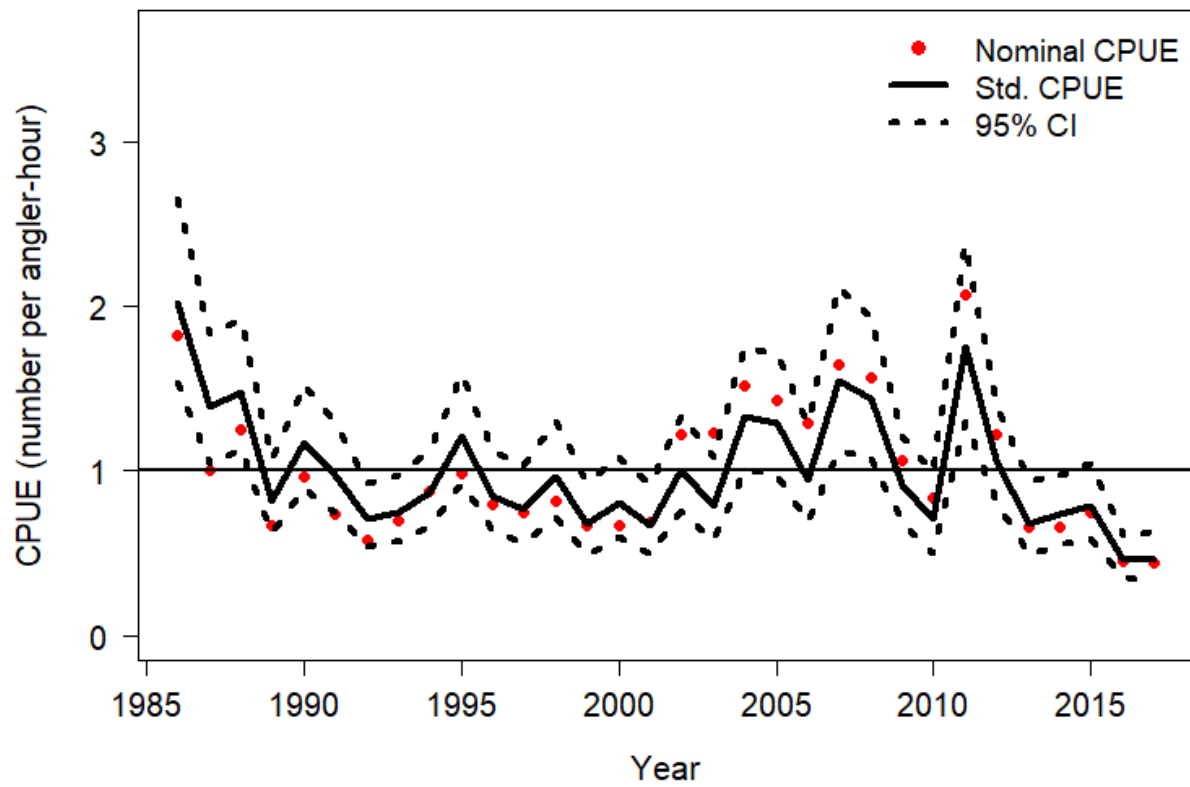

Figure 5.2. Standardized index with 95% confidence interval, and nominal CPUE for Scamp and Yellowmouth Grouper in the U.S. Gulf of Mexico for the Headboat fishery. The index was scaled to the mean value of the entire time series. This index was recommended for use.

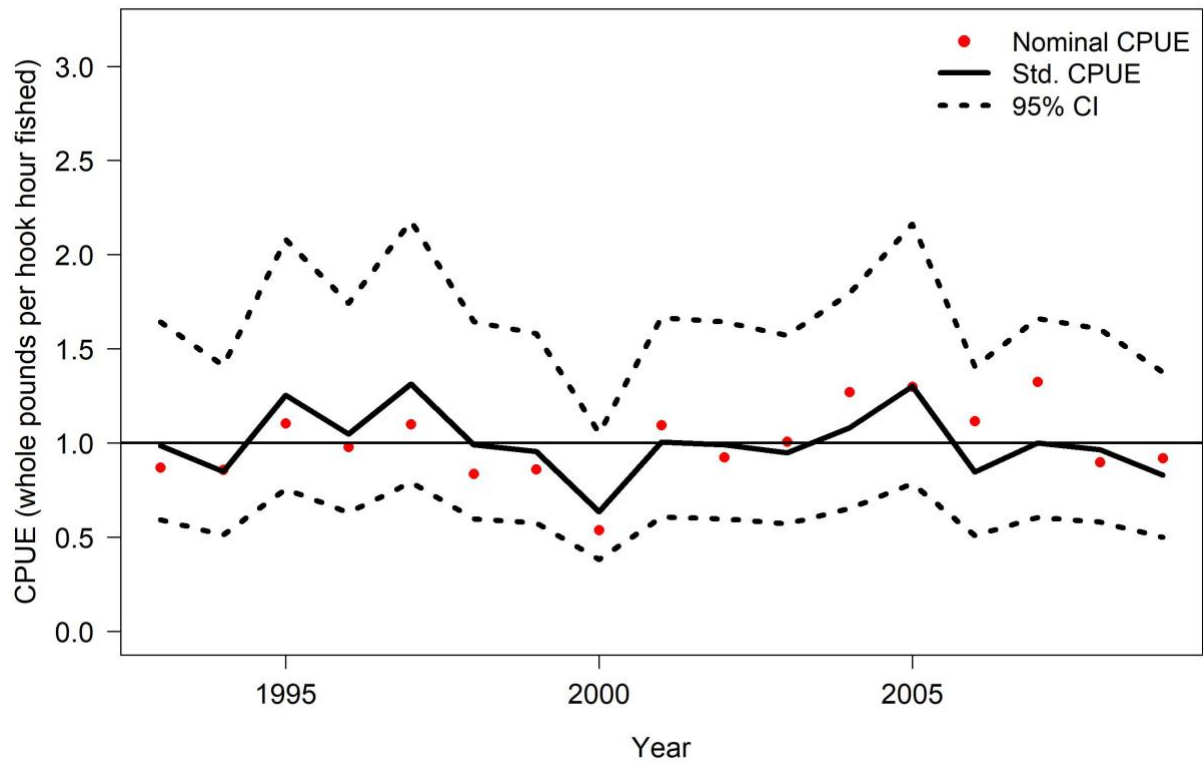

Figure 5.3. Standardized index with 95% confidence interval, and nominal CPUE for Scamp and Yellowmouth Grouper in the U.S. GOM for the Pre-IFQ Vertical Line fishery. The index was scaled to the mean value of the entire time series. This index was recommended for use.



Figure 5.4. Standardized index with 95% confidence interval, and nominal CPUE for Scamp and Yellowmouth Grouper in the U.S. GOM for the Post-IFQ Vertical Line fishery. The index was scaled to the mean value of the entire time series. This index was not recommended for use.

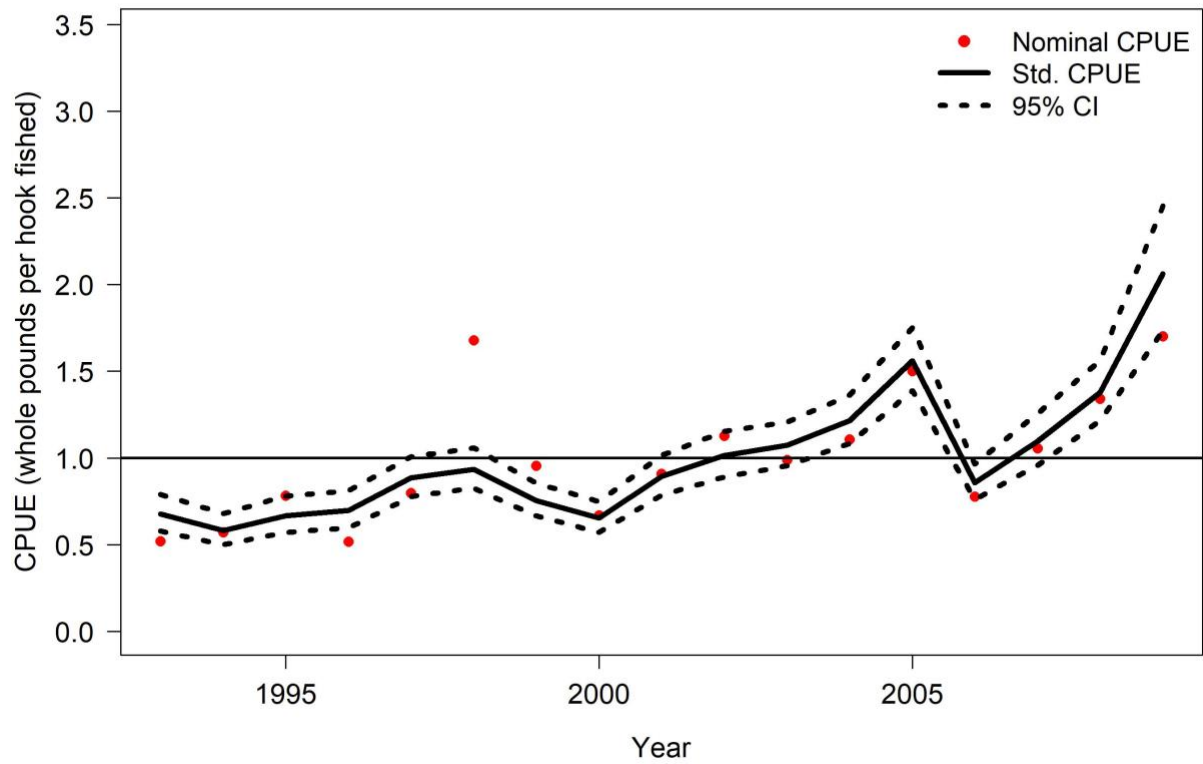

Figure 5.5. Standardized index with 95% confidence interval, and nominal CPUE for Scamp and Yellowmouth Grouper in the U.S. GOM for the Pre-IFQ longline fishery. The index was scaled to the mean value of the entire time series. This index was not recommended for use.



Figure 5.6. Standardized index with 95% confidence interval, and nominal CPUE for Scamp and Yellowmouth Grouper in the U.S. GOM for the Post-IFQ longline fishery. The index was scaled to the mean value of the entire time series. This index was not recommended for use.

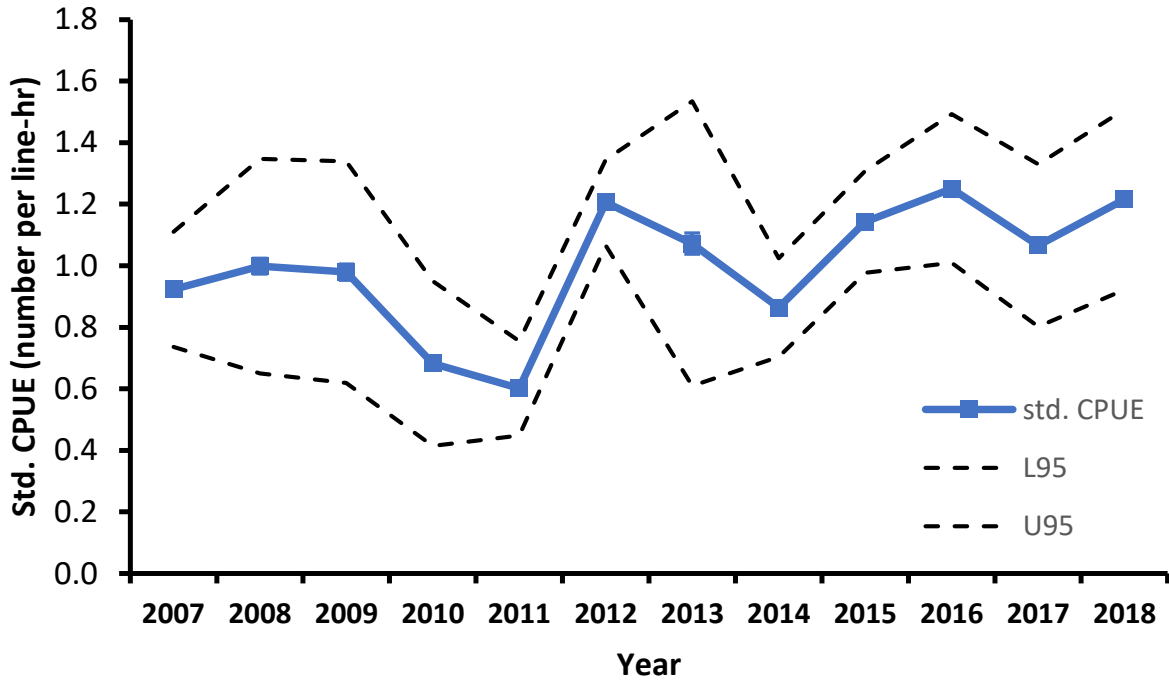

Figure 5.7. Time-series graph of reef fish observer standardized CPUE index ($\pm 95\%$ CI) for GOM Scamp/Yellowmouth Grouper for the commercial vertical line fleet.

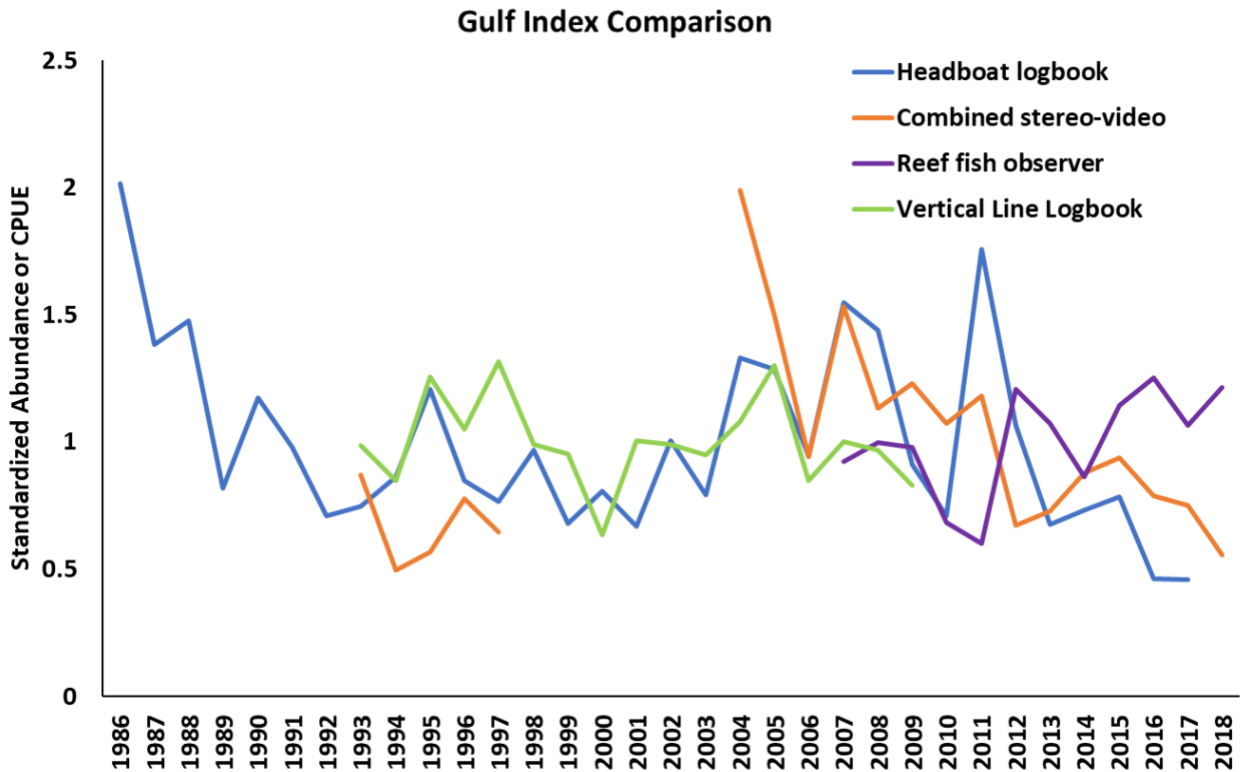

Figure 5.8. All indices (scaled to their respective means) recommended for potential use in the Scamp and Yellowmouth grouper stock assessment for the GOM region.

6 DISCARD MORTALITY AD-HOC WORKING GROUP

Data workshop panelists and data providers convened two ad-hoc working group meetings (led by Dominique Lazarre, FL FWCC/FWRI, St. Petersburg, FL) to present and discuss available data that could be used to inform recommendations for discard mortality rates for SEDAR 68. Anecdotal information, observed/assumed immediate mortality, and estimates of survival from an empirical study were presented by five data providers, representing both the Gulf of Mexico and South Atlantic regions. Commercial data sources included Mote Marine Laboratory (SEDAR68-DW-22) and the NOAA Reef Fish Observer / Shark Bottom Longline Observer Programs (SEDAR68-DW-16, SEDAR68-DW-17). Mote observed discarding of Scamp (N = 804) on commercial vessels in the Gulf of Mexico between 2016 and 2019 through their electronic monitoring program. These data indicated a low proportion of Scamp discards; 3.35% of Scamp were released, with only 0.75% of Scamp released dead. The NOAA Observer Programs have monitored discarding in both the bottom longline and vertical line fisheries in the

Gulf of Mexico since 2006. A range of immediate mortality estimates were provided, with the lower bound representing only observed dead Scamp (immediate mortality) and the upper bound including both dead discards and all discarded Scamp displaying barotrauma injury (assumed mortality). The observed to assumed immediate mortality ranged from 6.6% to 69.2% in the bottom longline fishery (N=228) and 0% to 41.8% in the vertical line fishery in the Gulf of Mexico (N=592, Table 1). The observed to assumed range of immediate mortality estimates was also provided for the vertical line fishery in the South Atlantic, 0.2%-16.5% (N = 491, Table 1).

Observations of immediate mortality in the recreational for-hire fisheries were provided by the Florida Fish and Wildlife Conservation Commission for both the Gulf of Mexico and South Atlantic (SEDAR68-DW-23, SEDAR68-DW-24). A summary of depth data from Scamp positive trips intercepted during state dockside intercept surveys and the at-sea observer data indicate the for-hire and private recreational fisheries tend to occur in depths shallower than 45 meters. Observations of discarding on for-hire vessels were summarized in a similar manner as those provided by the NOAA Observer Programs, the lower bound represents immediate observed mortality (immediate mortality) in the fisheries and the upper bound represents both immediate mortality and any fish observed with injuries (assumed mortality). In the Gulf of Mexico, the range of observed to assumed immediate mortality was reported to be 0.30% to 4.19% in the charter fishery (N = 334) and 2.13% to 11.64% in the headboat fishery (N = 1,452; SEDAR68-DW-24). Data from the South Atlantic were limited for the charter fishery, with no immediate mortality observed, from the six individuals observed. The observed to assumed immediate mortality for the headboat fishery ranged from 2.61% to 24.3% (N = 115). In addition to observer data, trip reports from two self-reporting platforms, MyFishCounts and the SAFMC Release applications, were summarized by representatives of the South Atlantic Fishery Management Council (SEDAR68-DW-25, SEDAR68-DW-26). These data provided primarily anecdotal information on the discarding behavior from participating anglers. The reports describe some rationale for discarding behavior and fishing practices, primarily that discarding during the open season occurs as a result of undersized fish being captured. Additionally, anglers reported that Scamp may be found in deeper water than some of the other shallow water grouper species being targeted, reducing interactions with this species.

Lastly, an empirical study that estimated survival of Scamp and Yellowmouth Grouper descended upon release was presented. Researchers captured 18 Scamp / Yellowmouth Grouper in depths ranging from 60 to 116 meters. Acoustic telemetry was used to track the fate of 16 Scamp that were descended, resulting in a survival estimate of 0.47 (0.27, 0.80). Two fish were released at the surface; one floated after release and was determined to be dead the second was tracked with telemetry, with its mortality documented later the same day. The working paper associated with this study provided an updated analysis that includes survival estimates for a complex of deepwater groupers (Gag, Red Grouper, Scamp, Snowy Grouper, Speckled Hind, and Yellowmouth Grouper). This updated analysis provided a survival estimate of 0.46 (0.33, 0.80; N=40) for groupers released with descender devices on the continental shelf break (SEDAR68-DW-27).

All the data provided were discussed in a second ad-hoc discard mortality session to determine how to use the available data to recommend discard mortality rates by fleet and jurisdictions. The group discussed the need for more empirical studies, as it is not likely that the surface release data provided by observer coverage fully captures post-release mortality. The group discussed the wide range of discard mortality estimates provided in the literature. It was widely accepted by the group that use of empirical studies that directly measure mortality / survival is optimal. It was also acknowledged that many of the empirical studies that estimate mortality / survival are conducted in depths that may not be representative of the commercial and recreational fleets. The group decided to use an approach that would combine available depth data that represents each fishery in conjunction with the species-specific logistic regression approach used by Pulver (2017) to estimate immediate mortality to provide point estimates for each commercial fleet. This analysis will be updated to provide upper and lower bounds during the assessment workshop. The group decided that a similar approach would be applied for the recreational fleet, with Jeff Pulver updating his analysis to create a model for recreational fisheries using observer data to fit the model. While these analyses are being updated, the group determined that the mean depth for each fishery would be used to provide a placeholder estimate in the assessment models.

Throughout the discussions, research recommendations were suggested that may help improve the available discard mortality estimates. These include:

- Conduct more empirical studies to investigate post-release mortality particularly in depth ranges that are representative of the fisheries
- Encourage use of modeling approaches to incorporate depth data into estimates of immediate mortality from the surface release data, potentially collaborating with empirical studies to generate more realistic estimates
- Improve data collection of depth data for each fleet, to allow additional modeling approaches to be employed to estimate a range of post-release mortality, particularly in the private boat recreational fleet
- Explore the use of descending devices and other barotrauma mitigation techniques (e.g. venting) on discard mortality estimates

An additional assessment working paper will be generated to document the additional analyses that will be conducted to generate point estimates with updated versions of the commercial and recreational models of the Pulver (2017) model.

6.1 LITERATURE CITED

Atkinson, Sarina F. 2020. Commercial Discard Length Composition for South Atlantic Scamp and Yellowmouth Grouper. SEDAR68-DW-16. SEDAR, North Charleston, SC. 8 pp.

Atkinson, Sarina F. 2020. Commercial Discard Length Composition for Gulf of Mexico Scamp and Yellowmouth Grouper. SEDAR68-DW-17. SEDAR, North Charleston, SC. 14 pp.

Byrd, Julia. 2020. Summary of the SAFMC Scamp Release Citizen Science Pilot Project for SEDAR 68. SEDAR68-DW-24. SEDAR, North Charleston, SC. 5 pp.

Collier, Chip. 2020. Voluntary reports of Scamp caught by private recreational anglers in MyFishCount for SEDAR 68. SEDAR68-DW-26. SEDAR, North Charleston, SC. 3 pp.

Lazarre, Dominique, Chris Wilson, Kelly Fitzpatrick. 2020. Scamp Length Frequency Distributions from At-Sea Headboat Surveys in the South Atlantic, 2005 to 2017. SEDAR68- DW-23. SEDAR, North Charleston, SC. 11 pp.

- Lazarre, Dominique. 2020. A Summary of Observer Data from the Size Distribution and Release Condition of Scamp Discards from Recreational Fishery Surveys in the Eastern Gulf of Mexico. SEDAR68-DW-24. SEDAR, North Charleston, SC. 20 pp.
- Neidig, Carole, L., Daniel Roberts, Max Lee, Ryan Schloesser. 2020. Preliminary Non Technical Fishery Profile and Limited Data Summary for Scamp, *Mycteroperca phenax* with Focus on the West Florida Shelf: Application of Electronic Monitoring on Commercial Snapper Grouper Bottom Longline Vessels. SEDAR68-DW-22. SEDAR, North Charleston, SC. 15 pp.
- Pulver, Jeff J. 2017. Sink or swim? Factors affecting immediate discard mortality for the Gulf of Mexico commercial reef fish fishery. Fisheries Research 188:166-172.
- Runde, Brendan J., Theo Michelot, Nathan M. Bacheler, Kyle W. Shertzer, and Jeffrey A. Buckel. 2020. Assigning fates in telemetry studies using hidden Markov models: an application to deepwater groupers released with descender devices. SEDAR68-DW-27. SEDAR, North Charleston, SC. 42 pp.

6.2 TABLES

Table 1. Proxy for release mortality observed in the NOAA Observer Programs. The lower bound classifies dead scamp using only onboard condition and the upper bound classifies dead scamp using a combination of onboard condition and disposition. † Included scamp alive with barotrauma. ‡ Included scamp with barotrauma and released dead.

| Gear | Depth Bin (m) | Lower Bound of Release Mortality | | | | Upper Bound of Release Mortality | | | |
|-----------------------|---------------|----------------------------------|-----------------|----------------------------|--------------|----------------------------------|-----------------|---------------|---------------------------|
| | | Number Discarded | Number of Trips | Percent Alive [†] | Percent Dead | Number Discarded | Number of Trips | Percent Alive | Percent Dead [‡] |
| SOUTH ATLANTIC | | | | | | | | | |
| Vertical Line | <40 | 146 | 24 | 100.00% | 0.00% | 146 | 24 | 84.90% | 15.10% |
| | 41-60 | 343 | 24 | 100.00% | 0.00% | 343 | 24 | 76.00% | 24.00% |
| | >60 | 2 | 15 | 99.40% | 0.60% | 2 | 15 | 89.70% | 10.30% |
| | <i>Total</i> | <i>491</i> | <i>43</i> | <i>99.80%</i> | <i>0.20%</i> | <i>491</i> | <i>43</i> | <i>83.50%</i> | <i>16.50%</i> |
| GULF OF MEXICO | | | | | | | | | |
| Vertical Line | <40 | 251 | 92 | 100.00% | 0.00% | 248 | 91 | 82.70% | 17.30% |
| | 41-80 | 216 | 107 | 100.00% | 0.00% | 216 | 107 | 55.60% | 44.40% |
| | >80 | 125 | 23 | 100.00% | 0.00% | 125 | 23 | 14.40% | 85.60% |
| | <i>Total</i> | <i>592</i> | <i>202</i> | <i>100.00%</i> | <i>0.00%</i> | <i>589</i> | <i>202</i> | <i>58.20%</i> | <i>41.80%</i> |
| Bottom Longline | <70 | 74 | 46 | 97.30% | 2.70% | 74 | 46 | 32.40% | 67.60% |
| | 71-100 | 124 | 53 | 91.10% | 8.90% | 123 | 52 | 27.60% | 72.40% |
| | >100 | 30 | 12 | 93.30% | 6.70% | 30 | 12 | 40.00% | 60.00% |
| | <i>Total</i> | <i>228</i> | <i>95</i> | <i>93.40%</i> | <i>6.60%</i> | <i>227</i> | <i>94</i> | <i>30.80%</i> | <i>69.20%</i> |



SEDAR

Southeast Data, Assessment, and Review

SEDAR 68

Gulf of Mexico Scamp Grouper

SECTION III: Assessment Process Report

August 2021

SEDAR
4055 Faber Place Drive, Suite 201
North Charleston, SC 29405

NOTE: Modifications to the model results reported in this report were made during the Review Workshop held August 30 – September 3, 2021. For complete results reflecting those changes, please see the Addendum of this Stock Assessment Report (Section VI).

This information is distributed solely for the purpose of peer review. It does not represent and should not be construed to represent any agency determination or policy.



SEDAR 68 Gulf of Mexico Scamp Grouper Research Track Assessment

Gulf Branch
Sustainable Fisheries Division
NOAA Fisheries - Southeast Fisheries Science Center

August 2021

Table of Contents

| | |
|--|----|
| 1. Assessment Process Proceedings | 4 |
| 1.1. Introduction | 4 |
| 1.1.1. Workshop Time and Place | 4 |
| 1.1.2. Terms of Reference | 4 |
| 1.1.3. List of Participants | 4 |
| 1.1.4. List of Assessment Process Working Papers and Reference Documents | 6 |
| 1.1.5. Panel Recommendations and comments on Terms of Reference | 6 |
| 2. Data Review and Update | 7 |
| 2.1. Stock Structure and Management Unit | 7 |
| 2.2. Life History Parameters | 8 |
| 2.2.1. Morphometric and Conversion Factors | 8 |
| 2.2.2. Age and Growth | 8 |
| 2.2.3. Natural Mortality | 8 |
| 2.2.4. Maturity | 9 |
| 2.2.5. Sexual Transition | 9 |
| 2.2.6. Fecundity | 9 |
| 2.2.7. Discard Mortality | 9 |
| 2.3. Fishery-Dependent Data | 10 |
| 2.3.1. Commercial Landings | 10 |
| 2.3.2. Recreational Landings | 10 |
| 2.3.3. Commercial Discards | 11 |
| 2.3.4. Recreational Discards | 11 |

- 2.3.5. Commercial Size Composition 12
- 2.3.6. Recreational Size Composition..... 12
- 2.3.7. Commercial Age Composition 12
- 2.3.8. Recreational Age Composition 12
- 2.3.9. Commercial Catch Per Unit of Effort Indices of Abundance 13
- 2.3.10. Recreational Catch Per Unit of Effort Indices of Abundance..... 13
- 2.3.11. Size Composition for RFOP Vertical Line Survey..... 13
- 2.4. Fishery-Independent Surveys..... 13
 - 2.4.1. Combined Video Survey Index..... 13
 - 2.4.2. Survey Length Composition 13
- 2.5. Contributions from Stakeholders 14
- 2.6. Environmental Considerations 14
- 3. Stock Assessment Model Configuration and Methods 14
 - 3.1. Stock Synthesis Model Configuration 14
 - 3.1.1. Initial Conditions 15
 - 3.1.2. Temporal Structure 15
 - 3.1.3. Spatial Structure..... 15
 - 3.1.4. Life History 15
 - 3.1.5. Recruitment Dynamics..... 16
 - 3.1.6. Fleet Structure and Surveys 17
 - 3.1.7. Selectivity 18
 - 3.1.8. Retention..... 19
 - 3.1.9. Landings and Age Compositions 20
 - 3.1.10. Discards..... 21
 - 3.1.11. Indices 21
 - 3.2. Goodness of Fit and Assumed Error Structure 22
 - 3.3. Estimated Parameters 22
 - 3.4. Model Diagnostics 23
 - 3.4.1. Residual Analysis..... 23
 - 3.4.2. Correlation Analysis 23
 - 3.4.3. Profile Likelihoods..... 23
 - 3.4.4. Jitter Analysis..... 23
 - 3.4.5. Retrospective Analysis..... 24
 - 3.4.6. Jack-knife Analysis on Indices of Abundance..... 24

- 3.4.7. Sensitivity Runs 24
- 4. Stock Assessment Model - Results 26
 - 4.1. Estimated Parameters and Derived Quantities 26
 - 4.2. Fishing Mortality 26
 - 4.3. Selectivity 27
 - 4.4. Retention 28
 - 4.5. Recruitment 29
 - 4.6. Biomass and Abundance Trajectories 30
 - 4.7. Model Fit and Residual Analysis 30
 - 4.7.1. Landings 30
 - 4.7.2. Discards 31
 - 4.7.3. Indices 32
 - 4.7.4. Length Compositions 33
 - 4.7.5. Age Compositions 34
 - 4.8. Model Diagnostics 36
 - 4.8.1. Correlation Analysis 36
 - 4.8.2. Profile Likelihoods 36
 - 4.8.3. Jitter Analysis 38
 - 4.8.4. Retrospective Analysis 38
 - 4.8.5. Jack-knife Analysis on Indices of Abundance 38
 - 4.8.6. Sensitivity Model Runs 39
- 5. Discussion 40
- 6. Acknowledgements 43
- 7. Research Recommendations 43
- 8. References 44
- 9. Tables 46
- 10. Figures 93

1. Assessment Process Proceedings

1.1. Introduction

1.1.1. Workshop Time and Place

The SEDAR 68 Assessment Process (AP) for Gulf of Mexico Scamp was conducted via a series of webinars held between December 2020 and May 2021.

1.1.2. Terms of Reference

The terms of reference approved by the Gulf of Mexico Fishery Management Council (GMFMC) are listed below.

1. Review any changes in data or analyses following the Data Workshop. Summarize data as used in each assessment model. Provide justification for any deviations from Data Workshop recommendations.
2. Develop population assessment model(s) that are appropriate for the available data.
3. Recommend biological reference points for use in management.
 - a. Consider how reference points could be affected by management, ecosystem, climate, species interactions, habitat considerations, and/or episodic events.
4. Provide estimates of stock population parameters, including:
 - a. Fishing mortality, abundance, biomass, selectivity, stock-recruitment relationship, sex ratio, and other parameters as necessary to describe the population
5. Characterize uncertainty in the assessment and estimated values.
 - a. Consider uncertainty in input data, modeling approach, and model configuration.
 - b. Provide appropriate measures of model performance, reliability, and ‘goodness of fit’.
 - c. Provide measures of uncertainty for estimated parameters and derived quantities such as biological reference points and stock status.
6. Provide recommendations for future research and data collection. Emphasize items that will improve future assessment capabilities and reliability. Consider data, monitoring, and assessment needs.
7. Complete an Assessment Workshop Report in accordance with project schedule deadlines.

1.1.3. List of Participants

Assessment Process Chair

Kai Lorenzen (Chair)GMFMC SSC

Assessment Development Team

| | |
|---|-------------------------|
| Francesca Forrestal, Co-Lead Analyst..... | NMFS Miami |
| Skyler Sagarese, Co-Lead Analyst | NMFS Miami |
| Churchill Grimes..... | SAFMC SSC |
| Will Patterson..... | GMFMC SSC/UFL |
| Sean Powers | GMFMC SSC/South Alabama |
| Marcel Reichert..... | SCDNR |
| Alexei Sharov..... | SAFMC SSC/MD DNR |
| Kyle Shertzer | NMFS Beaufort |
| Jim Tolan | GMFMC SSC/TPWD |

Assessment Process Participants

| | |
|--------------------|---------------|
| Dave Chagaris..... | GMFMC SSC/UFL |
|--------------------|---------------|

Appointed Observers

| | |
|---------------------|--------------|
| Randy McKinley..... | Industry Rep |
|---------------------|--------------|

Additional Observers

| | |
|----------------------------|----------------|
| Lisa Ailloud | NMFS Miami |
| Wally Bublely | SCDNR |
| Rob Cheshire..... | NMFS Beaufort |
| Chip Collier..... | SAFMC Staff |
| Nancie Cummings..... | NMFS Miami |
| LaTreese Denson | NMFS Miami |
| Joe Evans | SCDNR |
| Margaret Finch..... | SCDNR |
| Eric Fitzpatrick..... | NMFS Beaufort |
| Kelly Fitzpatrick | NMFS Beaufort |
| Keilin Gamboa-Salazar..... | SCDNR |
| Dawn Glasgow..... | SCDNR |
| Mandy Karnauskas..... | NMFS Miami |
| Michelle Masi | NMFS Galveston |
| Jeff Pulver | NMFS SERO |
| John Quinlan | NMFS Miami |
| Adyan Rios..... | NMFS Miami |
| McLean Stewart..... | NCDENR |
| Katie Siegfried | NMFS Miami |
| Wiley Sinkus..... | SCDNR |
| Carly Somerset..... | GMFMC |
| Tracey Smart..... | SCDNR |
| Matt Smith | NMFS Miami |
| Molly Stevens | NMFS Miami |
| Kevin Thompson..... | FL FWC |
| Brendan Turley | NMFS |
| Nathan Vaughan..... | NMFS |

Michelle Willis..... MARMAP/SCDNR

Council Representation

Tim Griner SAFMC

Staff

Julie Neer SEDAR

Mike Errigo..... SAFMC Staff

John Froeschke..... GMFMC Staff

Kathleen Howington..... SEDAR

Ryan Rindone..... GMFMC Staff

Mike Schmidtke..... SAMFC Staff

1.1.4. List of Assessment Process Working Papers and Reference Documents

| Documents Prepared for the Assessment Process | | | |
|--|---|--|-----------------|
| SEDAR68-AW-01 | Gulf of Mexico Scamp (<i>Mycteroperca phenax</i>) and Yellowmouth Grouper (<i>Mycteroperca interstitialis</i>) Commercial and Recreational Length and Age Compositions | Molly H. Stevens | 27 January 2021 |
| SEDAR68-AW-02 | A description of system dynamics of scamp populations in the Gulf of Mexico and South Atlantic to support ecosystem considerations in the assessment and management process | Matt McPherson and Mandy Karnauskas | 29 January 2021 |
| SEDAR68-AW-03 | SEDAR 68 Commercial Discard Mortality Estimates Based on Observer Data | Jeff Pulver | 9 March 2021 |
| SEDAR68-AW-04 | Estimation of a Commercial Abundance Index for Gulf of Mexico Scamp & Yellowmouth Grouper Using Reef Fish Observer Data | Steven G. Smith, Skyler Sagarese, Stephanie Martinez-Rivera, Kevin J. McCarthy | 29 March 2021 |

1.1.5. Panel Recommendations and comments on Terms of Reference

Term of Reference 1. Data streams and any changes following the Data Workshop are reviewed in **Section 2.**

Term of Reference 2. A fully integrated age and length based statistical-catch-at-age model configured using Stock Synthesis (SS) was used for the assessment. The model configuration is described in **Section 3.1**. See **Section 2** for a complete description of available data inputs.

Term of Reference 3. Biological reference points for use during the Operational Assessment are discussed in **Section 5**.

Term of Reference 4. Estimates of assessment model parameters (includes selectivity and stock-recruit parameters) and their associated standard errors are reported in **Section 4.1** and **Table 10**. Estimates of total and fleet-specific fishing mortality rates (units for Scamp: total biomass killed age 3+ / total biomass age 3+) are presented in **Table 11**. Estimates of stock biomass (metric tons), spawning stock biomass (units for Scamp: metric tons), abundance (exploitable, 3+ years), and recruitment are presented in **Table 12**, with sex-specific estimates and sex ratios provided in **Table 13**. Annual numbers-at-age (1,000s of fish) and biomass-at-age (metric tons) are provided for female and male Scamp in **Table 14** and **Table 15**, respectively.

Term of Reference 5. Uncertainty in the assessment and estimated values was characterized using model diagnostics and sensitivity analyses presented throughout **Section 4.8**. Estimates of uncertainty in data inputs are discussed throughout **Section 2**. Uncertainty in the assessment parameters and estimated values is presented in **Table 10**. Estimates of uncertainty surrounding derived quantities are shown as confidence intervals in relevant figures.

Term of Reference 6. Recommendations are provided in **Section 7**.

Term of Reference 7. This report satisfies this Term of Reference.

2. Data Review and Update

The following list summarizes the data inputs (and units) used in the assessment model (detailed in **Figure 1** along with their corresponding temporal scale):

1. Life history: meristics, age and growth, natural mortality, maturity, sexual transition, fecundity, ageing error
2. Discard mortality rates (based on numbers of fish)
3. Commercial and recreational landings (metric tons gutted weight)
4. Commercial and recreational discards (thousands of fish)
5. Conditional age-at-length composition and mean length-at-age of commercial landings
6. Age composition of recreational landings (1-year age bins, plus group ages 20 and older)
7. Length composition of landings and discards (3-cm Fork Length bins)
8. Fishery-independent abundance index: Combined Video Survey
9. Fishery-dependent abundance index: Commercial Vertical Line, Recreational Headboat, RFOP Vertical Line Survey
10. Length composition of surveys (3-cm Fork Length bins)

2.1. Stock Structure and Management Unit

The SEDAR 68 Stock ID Workshop recommended that the Gulf of Mexico and South Atlantic stocks be assessed separately using the default boundary of U.S. Highway 1 in the Florida Keys,

as defined by the Councils' jurisdictions (SEDAR68-SID-05). Due to species misidentification issues with Yellowmouth Grouper (*Mycteroperca interstitialis*), it also recommended that both Scamp and Yellowmouth Grouper be assessed jointly, with the two species treated as a single complex. The data submitted for use in the assessment likely represent both species in unknown proportions, with most data reported as Scamp (e.g., 0.14% and 2.3% of commercial and recreational (charter and private) landings, respectively, attributed to Yellowmouth Grouper). For the purpose of brevity, all reference to Scamp in this report refers to the Scamp and Yellowmouth Grouper complex.

2.2. Life History Parameters

2.2.1. Morphometric and Conversion Factors

The relationship between gutted weight (in kilograms) and fork length (in centimeters; $W = aFL^b$) for both sexes combined was used (**Table 1, Figure 2A**). Although not a direct input into the model, the whole weight to gutted weight conversion (**Table 1**) was used to convert the recreational landings in whole weights into gutted weights for input into the model (**Section 2.3.2**).

2.2.2. Age and Growth

Growth was modeled using a single size-modified von Bertalanffy growth curve for both sexes combined (**Table 2, Figure 2B**). The SEDAR 68 AP used the population model with the constant CV-at-age (CV = 0.130) because this model exhibited the lowest AIC, and examination of the variance structure for observed size-at-age data supported a constant CV for most ages, with the exception of the older age classes where sample sizes were small.

No concerning bias in ageing of Scamp was evident across laboratories or readers (SEDAR68-DW-15). Overall, the APE for Gulf of Mexico Scamp was 5.14%. Processing errors unique to Scamp in the Gulf of Mexico led to the exclusion of all age data between 2003 and 2012. As a result, placeholder calendar age estimates developed by the SEDAR 68 DW Life History Working Group (LHWG) using otolith weight as a proxy for calendar age were recommended for use. To account for uncertainty in the ageing process, SD-at-age were calculated and used as a measure of ageing error in the assessment model. As expected, uncertainty in age estimates increased with age, with wider distributions of observed ages noted for older Scamp (**Figure 3**).

2.2.3. Natural Mortality

The age-specific vector of natural mortality (M) was updated during the SEDAR 68 AP to account for a shift in peak spawning and to implement the Lorenzen (2000) approach for scaling M , which deviates from the SEDAR 68 DW LHWG recommendation of the Lorenzen (1996) approach. This updated M vector assumes a size-dependent mortality schedule in which the instantaneous mortality rate-at-age is inversely proportional to length-at-age and requires: (1) von Bertalanffy growth parameters (**Section 2.2.2**); (2) the first age at vulnerability into the fishery (6 years); and (3) peak spawning around April 15th. The age-specific M vector was then scaled to the Then et al. (2015) point estimate of 0.155 yr⁻¹, which was obtained by recalculating the t_{max} regression using Serranid data and a maximum age of 34 years (**Table 3, Figure 2C**).

2.2.4. Maturity

Scamp are protogynous hermaphrodites (i.e., transition from female to male), and all male or transitioning fish were considered mature in this assessment. A logistic relationship with a logit link function was recommended by the SEDAR 68 DW LHWG to model maturity as a function of age (SEDAR68-DW-28), with the age at 50% maturity predicted around 3.4 years (**Figure 2D**).

2.2.5. Sexual Transition

Hermaphroditism in Stock Synthesis (SS) is modeled as the proportion of individuals transitioning at a given age using a scaled cumulative normal distribution based on three parameters. The inflection age represents the age at which 50% of individuals transition to male, and differs from the traditional 50% probability of being male, which was predicted around 10.8 years (SEDAR68-DW-28; **Figure 2E**). The SD controls how quickly the asymptote is reached. Lastly, the maximum value represents the asymptotic proportion of transition, and can be less than 1 if females still occur in the plus group (i.e., not 100% transition by the maximum age). For this analysis, all individuals sampled from the reproductive study were used and resulted in the following estimates: inflection age = 21.525, SD in age = 10.141 and asymptote = 0.891 (**Figure 2E**).

2.2.6. Fecundity

The SEDAR 68 DW LHWG recommended using combined male and female spawning stock biomass (SSB) as a measure of reproductive potential (i.e., SSB equivalent to body weight, **Figure 2F**).

2.2.7. Discard Mortality

Discard mortality estimates recommended by the SEDAR 68 Discard Mortality Working Group (DMWG) were obtained from a literature review in combination with species-specific logistic regression analysis following Pulver (2017). The total discard mortality rate for each commercial fleet was estimated by conditionally combining the immediate unvented and delayed mortality estimates (**Table 4**; SEDAR68-AW-03). Data logistics and time limitations prevented the completion of a similar analysis for the recreational fleets using the FWRI At-Sea Observer data. Therefore, data from the Southeast Regional Headboat Survey (SRHS) were used to determine the mean discard depth (29 m) for Scamp in the Gulf of Mexico. The SEDAR 68 DMWG used the RFOP model to predict the immediate discard mortality at this depth, which was 9-10%. Combined with a bootstrapped delayed mortality prediction of 18% (7-33%) at 30 m, the total discard mortality estimate was 26% (16-40%). For the Gulf of Mexico, discard mortality was assumed similar between the Recreational Charter Private and Recreational Headboat fleets by the SEDAR 68 DMWG due to similarities between fishing practices, targeting, and depths where Scamp were discarded.

2.3. Fishery-Dependent Data

2.3.1. Commercial Landings

Commercial landings of Scamp were constructed using data from the Florida Trip Ticket program for West Florida since 1986 and data housed in the NOAA's Southeast Fisheries Science Center's (SEFSC) Accumulated Landings System for the remaining Gulf States. Landings from the Grouper-Tilefish Individual Fishing Quota (IFQ) program were used for 2010 to 2017. Commercial landings since 1986 were used in the assessment (**Table 5**). Historical landings (i.e., pre-1986) were deemed highly unreliable and not recommended for use by the SEDAR 68 DW Commercial Working Group (ComWG). As Scamp have been consistently reported by species since 1986, the ADT supported the exclusion of data prior to 1986. Vertical line and longline landings comprised approximately 50.4% (range: 37 - 57.6%) and 39.7% (range: 25.2 - 50.1%) of total commercial landings since 1986, respectively. Other gear landings have averaged 9.8% of total commercial landings, and range from 0.6% in 2016 to 27.5% in 1999.

For the assessment, commercial landings were partitioned into two fleets that represent the two main commercial harvesting gears: (1) vertical line or handline and (2) longline (**Section 3.1.6**). Commercial Vertical Line landings have declined since the early 1990s, whereas Commercial Longline landings have remained variable across years (**Figure 4**). The proportion of commercial landings has varied over time, but has decreased considerably in recent years.

Commercial landings were reported in pounds gutted weight and converted to metric tons for input to the assessment model. Uncertainty estimates were not provided by the SEDAR 68 DW ComWG for landings from the Gulf of Mexico. The ADT supported borrowing the uncertainty estimate of 0.05 for Florida from 1986 through 2009 (Table 3.4 in South Atlantic DW Report), and implementing a lower error of 0.01 since 2010, which corresponds to the implementation of the IFQ program in the Gulf of Mexico.

2.3.2. Recreational Landings

Recreational landings data reviewed at the SEDAR 68 DW included both whole weights (gutted weights shown in **Table 6A**) and numbers (**Table 6B**). Weight estimates were developed by the SEFSC and used the Marine Recreational Information Program (MRIP; SEDAR68-DW-13) sample data to obtain a mean body weight by strata using the following hierarchy (from coarsest to finest): species, region, year, state, mode, wave, and area (Matter and Rios 2013). Mean body weights were then multiplied by the landings estimates in numbers to obtain estimates of landings in weight.

For the assessment, recreational landings were partitioned into two fleets that represent the two main recreational harvesting modes of fishing: (1) Charter Private and (2) Headboat (**Section 3.1.6**). Recreational landings of Scamp for the Recreational Charter Private fleet were estimated using data from MRIP, Texas Parks and Wildlife Department (TPWD), and Louisiana Creel. Since 1986, Recreational Charter Private fleet landings have averaged approximately 94.8% of total recreational landings in gutted pounds, and have ranged from 77.3% in 1990 to 99.3% in 2009. Recreational landings of Scamp for the Recreational Headboat fleet were estimated using data from SRHS. Recreational Headboat fleet landings have averaged approximately 5.1% of

total recreational landings in gutted pounds, and have ranged from 0.7% in 2009 to 44.2% in 1990.

For the assessment, recreational landings were input in gutted weights (**Figure 4**). While past assessments have input recreational landings as numbers of fish, which are the native units of data collection by the MRIP program (and other state sampling programs), this assessment input recreational landings in weights to be more consistent with how the stock is managed (i.e., Annual Catch Limit is monitored in weights). Recreational Charter Private landings have varied considerably over the time series, with relatively high landings in the 1980s and in many years since 2005 (**Figure 4**). Recreational Headboat landings have remained consistently low throughout the time series, with the exception of slightly higher landings in the late 1980s and in 2015 (**Figure 4**). The proportion of recreational landings has varied over time, but has increased in recent years.

Recreational landings in pounds gutted weight were converted to metric tons for input to the assessment model. Uncertainty estimates were provided by the SEDAR 68 DW Recreational Working Group (RecWG) for both the Recreational Charter Private and Recreational Headboat fleets. Uncertainty estimates (CV) were much larger for the Recreational Charter Private fleet, averaging about 0.43 and ranging from 0.21 in 1998 and 2001 to 0.89 in 1990. In comparison, uncertainty estimates (CV) for the Recreational Headboat fleet were much smaller and averaged about 0.03 (range: 0 - 0.1), primarily a function of the SRHS being a census of headboats. Additional details on uncertainty estimation for the Recreational Charter Private and Recreational Headboat fleets can be found in SEDAR68-DW-09 and SEDAR68-DW-31, respectively.

2.3.3. Commercial Discards

Commercial discards were estimated using catch per unit effort (CPUE) from the coastal observer program and total fishing effort from the commercial reef logbook program (SEDAR68-DW-30). The discard estimates reported in numbers were input into the assessment as 1,000s of fish with corresponding log-scale standard errors (SE, **Table 7**). For the Commercial Vertical Line and Commercial Longline fleets, SEs averaged 0.41 (range: 0.39-0.42) and 0.42 (range: 0.33-0.5), respectively. Discard mortality rates of 0.47 and 0.68 were used for the Commercial Vertical Line and Commercial Longline fleets, respectively (**Table 4**).

2.3.4. Recreational Discards

For the Recreational Charter Private fleet, discard estimates starting in 1986 were provided solely by MRIP because discards from the LA Creel survey and TPWD survey were assumed negligible. Discard estimates for the Recreational Headboat fleet began in 2000 because discards prior to the implementation of the federal size limit in 1999 were assumed negligible. Between 2000 and 2003, discards from the Recreational Headboat fleet were estimated using a proxy method that used the mean SRHS discard:landings ratio (2004-2018) to estimated headboat landings. From 2004 through 2017, Recreational Headboat fleet discards were provided by SRHS. The discard estimates reported in numbers were input into the assessment as 1,000s of fish with corresponding log-scale SEs (**Table 8**). For the Recreational Charter Private fleet, SEs averaged 0.52 (range: 0.31-0.83). A SE of 0.47 was used in the absence of a value recommended by the SEDAR 68 DW RecWG, and was similar to estimates used for other Gulf stocks (e.g.,

Gag Grouper, *Mycteroperca microlepis*). A discard mortality rate of 0.26 was used for both recreational fleets (**Section 2.2.7**).

2.3.5. Commercial Size Composition

Annual length compositions were combined into 3-cm FL bins following exploratory data analyses (smaller bin sizes exhibited too many zeros). For each fleet, length data of landed Scamp from the commercial trip intercept program (TIP) and GulfFIN were aggregated into three major sub-regions and weighted based on the distribution of landings estimates among sub-regions (SEDAR68-AW-01). Data from the RFOP were used to characterize the length compositions from commercial discards (SEDAR68-DW-17). Annual length compositions were input into the model along with input sample sizes reflective of the number of trips (≥ 10).

2.3.6. Recreational Size Composition

Annual length compositions were combined into 3-cm Fork Length interval bins following exploratory data analyses (smaller bin sizes exhibited too many zeros). For each fleet, length data of landed Scamp were obtained from MRIP (formerly MRFSS), TPWD, SRHS and GulfFIN. Nominal length compositions were used in the assessment for each recreational fleet due to insufficient sample sizes (SEDAR68-AW-01). Length composition samples provided by Florida Fish and Wildlife Conservation Commission's (FWC) Fish and Wildlife Research Institute's (FWRI) At-Sea Observer Program (2006-2017) were used for characterizing the discards for both recreational fleets (SEDAR68-DW-24). Annual length compositions were input into the model along with input sample sizes reflective of the number of trips (≥ 10).

2.3.7. Commercial Age Composition

Conditional age-at-length (CAAL) compositions of landed Scamp by both Commercial Vertical Line and Commercial Longline fleets were developed during the SEDAR 68 AP and used in the assessment (**Figures 5A-5B**). A separate age-length composition was specified for each 3-cm Fork Length bin containing Scamp whose ages had been estimated. This linkage provides more detailed information on the size-age relationship to be incorporated into the growth model fitting process. For SEDAR 68, this data input was selected over age composition because using CAAL avoids double use of fish for both age and length compositions, especially when age compositions are weighted by length compositions (as presented in SEDAR68-AW-01). The ADT supported this approach because the Trip Interview Sampling program measure lengths from all randomly selected fish (randomly selected from each market size category where necessary; Saari and Beerkircher 2014). Including CAAL compositions can contain more detailed information about the relationship between size and age, and can assist in the estimation of growth parameters, especially the variance of size-at-age (Methot et al. 2020). A mean length-at-age vector for each year and fleet was included in the model for comparison between the model expected length-at-age and the observed length-at-age.

2.3.8. Recreational Age Composition

Nominal age compositions of landed Scamp were provided for both recreational fleets due to data limitations preventing weighting of compositions (SEDAR68-AW-01). Recreational age data were not input as conditional age-at-length due to concerns over the numerous sampling programs (e.g., MRIP, SRHS, Gulf States) and their varying sampling designs. Annual age

compositions were input into the model along with input sample sizes reflective of the number of trips (≥ 10).

2.3.9. Commercial Catch Per Unit of Effort Indices of Abundance

Two commercial catch-per-unit-effort (CPUE) indices of relative abundance were recommended by the SEDAR 68 DW Index Working Group (IWG) for use in the assessment. The pre-IFQ index for the Commercial Vertical Line fleet was recommended for use (SEDAR68-DW-29) because of its long and fairly consistent time series before the frequent implementation of regulations (i.e., 2010+). A novel CPUE index was developed for the Commercial Vertical Line fleet using data from the RFOP (SEDAR68-AW-04). Observer observations of catch include both kept and discarded fish, and are thus not directly impacted by changes in management regulations such as size limits or catch quotas. Annual CVs associated with each of the standardized indices were converted to log-scale SEs using the approximation: $\log_e(SE) = \sqrt{(\log_e(1 + CV^2))}$ provided in Methot et al. (2020). The SEs as well as all index values by source are presented in **Table 9**.

2.3.10. Recreational Catch Per Unit of Effort Indices of Abundance

The Recreational Headboat CPUE index was recommended by the SEDAR 68 DW IWG for use in the assessment (SEDAR68-DW-18) because of its long and consistent time series and large spatial coverage. Annual CVs were converted to log-scale SEs (**Section 2.3.9**) and are presented in **Table 9**.

2.3.11. Size Composition for RFOP Vertical Line Survey

Annual length compositions of total catch (landed + discarded) for the RFOP Vertical Line Survey were combined into 3-cm Fork Length interval bins following exploratory data analyses (smaller bin sizes exhibited too many zeros). Annual length compositions were input into the model along with input sample sizes reflective of the number of sampling units, or the number of valid Scamp sample units that were sampled by observers (SEDAR68-AW-04).

2.4. Fishery-Independent Surveys

2.4.1. Combined Video Survey Index

An index combining the three individual surveys (NMFS SEAMAP reef fish, Panama City, and FWC FWRI) using a habitat-based approach was recommended for use because it has a statistically sound survey design, has good coverage of Scamp habitat and, therefore, should reflect relative abundance (**Table 9** and SEDAR68-DW-07). Annual CVs were converted to log-scale SEs (**Section 2.3.9**) and are presented in **Table 9**.

2.4.2. Survey Length Composition

A model-based approach was used to develop size composition of Scamp from the Combined Video Survey. These composition values are model estimated probabilities from a multinomial regression model using length bins (in 3-cm Fork Length) as the response variable, and is based on the approach applied for Vermilion Snapper (*Rhomboplites aurorubens*, Walter et al. 2020) and Red Snapper (*Lutjanus campechanus*, Walter et al. 2017). Model factors included year as a

categorical factor, habitat type, and survey (i.e., Lab) as a categorical factor. The final model selected was based on Akaike's Information Criterion and included year and survey. Annual length compositions were input into the model along with input sample sizes reflective of the number of stations (≥ 10).

2.5. Contributions from Stakeholders

A conceptual model focused on Gulf of Mexico Scamp was built by the SEFSC using responses from an online survey (with follow-up telephone interviews) and the Something's Fishy Survey from the Gulf Council. The purpose of this pilot exercise was to increase understanding of drivers and linkages that are most likely to influence the larger socio-ecological system in which Scamp occur. The conceptual model was composed of a variety of factors influencing Scamp (**Figure 6**), with additional details summarized in SEDAR68-AW-02. Importantly, regulations on other species (e.g., seasonal closures of Gag Grouper) were thought to be more influential than regulations on Scamp. While the relationships identified by the model and summarized above reflect working hypotheses and not necessarily known truths, these hypotheses can direct further research to help identify factors that should be considered either in the assessment model or by management.

2.6. Environmental Considerations

While red tide events were hypothesized to have a negative impact according to the conceptual map, only a single oral history interview conducted by the SEFSC in response to the 2018 red tide event explicitly mentioned Scamp (N = 64 interviews; SEDAR72-WP-09). Further, only one out of 32 responses in the GMFMC Something's Fishy Survey mentioned red tide in relation to the devastation following the 2005 event. A comparison of the spatial distribution of Scamp (SEDAR68-SID-02) and areas of hypoxia (potentially due to red tide events; SEDAR72-WP-10) revealed limited spatial overlap (**Figure 7**), suggesting that red tide events may not have a severe impact on Scamp since they tend to be more abundant in deeper areas.

3. Stock Assessment Model Configuration and Methods

3.1. Stock Synthesis Model Configuration

The assessment model used was Stock Synthesis (hereafter referred to as SS), version 3.30.16.05;_2021_03_04. Descriptions of SS algorithms and options are available in the SS User's Manual (Methot et al. 2020), the NOAA Fisheries Toolbox website (<http://nft.nefsc.noaa.gov/>), and Methot and Wetzel (2013). SS is a widely used integrated statistical catch-at-age model (SCAA) that has been tested for stock assessments in the United States (US), particularly on the West Coast and Southeast, and also throughout the world (see Dichmont et al. 2016 for review). SCAA models consist of three closely linked modules: the population dynamics module, an observation module, and a likelihood function. Input biological parameters (e.g., **Section 2.2**) are used to propagate abundance and biomass forward from initial conditions (population dynamics model) and SS develops expected data sets based on estimates of fishing mortality, selectivity, and catchability (the observation model). The observed and expected data are compared (the likelihood module) to determine best fit parameter estimates using a statistical maximum likelihood framework (detailed in Methot and Wetzel [2013]). Because many inputs are correlated, the concept behind SS is that processes should be modeled

together, which helps to ensure that uncertainties in the input data are properly accounted for in the assessment.

The SS modeling framework provides estimates for key derived quantities including: time series of recruitment (units: 1,000s of age-0 recruits), abundance (units: 1,000s of fish), biomass (units: metric tons), SSB (units for Scamp: metric tons), and harvest rate (units for Scamp: total biomass killed age 3+ / total biomass age 3+). The r4ss software (Taylor et al. 2021) was utilized extensively to develop various graphics for model outputs and was also used to summarize various output files and perform diagnostic runs.

3.1.1. Initial Conditions

The Gulf of Mexico Scamp assessment begins in 1986 and has a terminal year of 2017. A start year of 1986 was primarily based on the recommendation by the SEDAR 68 DW ComWG (**Section 2.3.1**). However, most data streams do not contain data prior to 1986, with the exception of uncertain historical recreational landings (SEDAR68-DW-12, CV = 0.67), uncertain recreational discard estimates between 1981 and 1985 (SEDAR68-DW-09, CV range: 0.37-0.66), and sporadic composition data (SEDAR68-AW-01). Since removals of Scamp are known to have occurred in the Gulf of Mexico prior to 1986 for both commercial and recreational fisheries, the stock was not assumed to be at equilibrium and initial conditions were estimated from initial equilibrium catches (mean landings over the first five years, 1986-1991). Ultimately, an initial fishing mortality rate for the Recreational Headboat fleet was not estimated in the SEDAR 68 AP Base Model because it bounded out near zero due to very minimal catches by this fleet (**Figure 4**).

3.1.2. Temporal Structure

The Scamp population was modeled from age-0 through age-34 (the maximum age), with data bins spanning age-0 through age-20+, with the last age representing a plus group (encompassing only 3% of otoliths). SS starts at age-0 (Methot et al. 2020). Data collection and fishing activities were assumed relatively continuous throughout the year; therefore, inclusion of a seasonal component to the removals was not deemed necessary. The fishing season was assumed to be continuous and homogeneously distributed throughout the year.

3.1.3. Spatial Structure

A single area model was implemented where recruits are assumed to homogeneously settle across the entire Gulf of Mexico.

3.1.4. Life History

A fixed power function length-weight relationship ($a = 1.186 \times 10^{-5}$, $b = 3.04$) was used to convert body length (cm Fork Length, FL) to body weight (kg gutted weight; **Table 1, Figure 2A**). SS moves fish among age classes and length bins on January 1st of each modeled year starting from birth at age-0. Because the ‘true’ birth date often does not occur on January 1st, with peak spawning occurring around April 15th for Scamp in the Gulf of Mexico, some slight alterations in growth (t_0 , or the age at length 0) and natural mortality parameters are required to account for the difference between true age and modeled age when parameters are input instead of estimated.

Growth within SS was modeled with a three parameter von Bertalanffy equation: (1) L_{Amin} (cm FL), the size of age-1 Scamp (10.19 cm FL); (2) L_{Amax} (cm FL), the size of maximum aged Scamp (70.22 cm FL); and (3) K (year^{-1}), the growth coefficient (0.134 year^{-1}). In SS, when fish recruit at the real age of 0.0 they have a body size equal to the lower limit of the first population bin (fixed at 3 cm FL). Fish then grow linearly until they reach a real age equal to the input value of A_{min} (growth age for L_{Amin}) and have a size equal to L_{Amin} . As they age further, they grow according to the von Bertalanffy growth equation (**Figure 2B**). L_{Amax} was specified as equivalent to L_{∞} . Two additional parameters are used to describe the variability in size-at-age and represent the CV in length-at-age at A_{min} (age-1; $CV_{Amin} = 0.13$) and A_{max} (age 20; $CV_{Amax} = 0.13$). For intermediate ages, a linear interpolation of the CV on mean size-at-age is used. Model runs attempting estimation of all five growth parameters (L_{Amax} [i.e., L_{∞}], L_{Amin} , K , CV_{Amin} , and CV_{Amax}) resulted in a K estimate toward the lower bound (0.05) and an L_{∞} estimate near the upper bound (100; **Section 4.8.6**). As a result, only L_{Amin} was estimated in the SEDAR 68 AP Base Model with the remaining growth parameters fixed within SS at the values recommended in **Section 2.2.2 (Table 2)**.

The age-specific vector of M (**Section 2.2.3**) was fixed within the SS model (**Table 3, Figure 2C**).

The assessment model was set-up with two genders to account for the reproductive biology of Scamp. As protogynous hermaphrodites, Scamp are born female (i.e., 100% female at birth), and starting at age-3, a portion of the population transitions to male. The two-gender SS model treated males and females identically, and data were input as combined due to the lack of sex-specific fisheries data. Immature females transitioned to mature females based on a fixed logistic function of age (**Figure 2D**). The three required parameters to define the hermaphroditism transition rate (inflection age = 21.525, SD in age = 10.141, and asymptote = 0.891) were estimated externally to SS (**Section 2.2.5**) and fixed in the assessment model (**Figure 2E**). Reproductive potential was defined in terms of male and female combined SSB (**Figure 2F**).

3.1.5. Recruitment Dynamics

A Beverton-Holt stock-recruit function was used to parametrize the relationship between spawning output and resulting recruitment of age-0 fish. The stock-recruit function (representing the arithmetic mean spawner-recruit levels) requires three parameters: (1) steepness (h) characterizes the initial slope of the ascending limb (i.e., the fraction of virgin recruits produced at 20% of the equilibrium spawning biomass); (2) the virgin recruitment (R_0 , estimated in log space) represents the asymptote or virgin recruitment levels; and (3) the variance or recruitment variability term (σ_R) which is the SD of the log of recruitment (it both penalizes deviations from the spawner-recruit curve and defines the offset between the arithmetic mean spawner-recruit curve and the expected geometric mean from which the deviations are calculated).

Although the spawner-recruit parameters are often highly correlated, they can be simultaneously estimated in SS. All three stock-recruit parameters were directly estimated in the SEDAR 68 AP Base Model. The starting value of steepness was given an informative prior of 0.84 (SD = 1), which is the mode of the beta distribution obtained in the Shertzer and Conn (2012) meta-analysis, and has been used in prior Gulf grouper assessments.

Annual deviations from the stock-recruit function were estimated in SS as a vector of deviations forced to sum to zero and assuming a lognormal error structure. A lognormal bias adjustment factor was applied to recruitment estimates as recommended by Methot et al. (2020), but only to the data-rich years in the assessment. This was done so that SS will apply the full bias-correction only to those recruitment deviations that have enough data to inform the model about the full range of recruitment variability (Methot et al. 2020). For the SEDAR 68 AP Base Model, no recruitment deviations were estimated in the early period (i.e., pre-1986). Full bias adjustment was used from 1987 to 2014 when length or age composition data are available. Bias adjustment was phased in linearly, from no bias adjustment prior to 1977 to full bias adjustment in 1987. Bias adjustment was phased out in 2014, decreasing from full bias adjustment to no bias adjustment in that year, because the age composition data contains little information on recruitments in more recent years. The years selected for full bias adjustment were estimated following the methods of Methot and Taylor (2011).

3.1.6. Fleet Structure and Surveys

Four fishing fleets were modeled and had associated length, conditional age-at-length (commercial) or age (recreational) compositions. The fleets were: Commercial Vertical Line (ComVL), Commercial Longline (ComLL), Recreational Charter Private, and Recreational Headboat. Fleet structure was characterized by the availability of length and age composition data, comparisons of length distributions between gears (commercial) or modes (recreational), and resulting sample sizes. Two commercial fleets were modeled based on differences in length compositions of landed Scamp, with the Commercial Longline fleet tending to land larger Scamp compared to the Commercial Vertical Line fleet (**Figure 8A**). Although the landings from the Recreational Headboat fleet were minor compared to the Recreational Charter Private fleet, these fleets were modeled separately due to notable differences in length compositions of landed Scamp, with smaller Scamp landed by the Recreational Headboat fleet compared to the Recreational Charter Private fleet (**Figure 8B**). Limited sample sizes for the private mode led to its lumping with the charter mode, largely based on discussions of similarities in angler behavior. Recreational Charter Private mode landings and compositions (age and length) were summed across modes and a single selectivity curve and time series of fishing mortality were estimated.

Three fishery-dependent CPUE indices were included in the SEDAR 68 AP Base Model: pre-IFQ Commercial Vertical Line (CPUE units: biomass kept per hook hour), SRHS Recreational Headboat (CPUE units: number kept per angler hour), and RFOP Vertical Line Survey (CPUE units: number kept or discarded per line hour). CPUE was treated as an index of biomass or abundance where the observed standardized CPUE time series was assumed to reflect annual variation in population trajectories. Both the pre-IFQ Commercial Vertical Line and SRHS Recreational Headboat CPUE indices were of landings only, and the selectivity of each was assumed identical to the associated fleet. The RFOP Vertical Line Survey was input as a survey into SS (**Section 2.3.9**). The length composition was fit directly based on the estimated length-based selectivity function.

A single fishery-independent survey, the Combined Video Survey, was included in the SEDAR 68 AP Base Model. This survey was treated in the same way as CPUE indices, except that it had its own unique selectivity function estimated from length composition data. The Combined Video Survey index was believed to reflect abundance of juveniles and adults. Because no age

information was available for the survey, the length composition was fit directly based on estimated length-based selectivity functions.

3.1.7. Selectivity

Selectivity represents the probability of capture by age or length for a given fleet and represents the net result of multiple interrelated factors (e.g., gear type, targeting, and availability of fish due to spatial and temporal structure). Length-based selectivity patterns were specified for each fleet and survey and were characterized as one of two functional forms: (1) a two-parameter logistic function or (2) the six-parameter double normal function. A logistic curve implies that fish below a certain size range are not vulnerable, but then gradually increase in vulnerability with increasing size until all fish are fully vulnerable (asymptotic selectivity curve). Two parameters describe logistic selectivity: (1) the length at 50% selectivity, and (2) the difference between the length at 95% selectivity and the length at 50% selectivity, which were both estimated in this assessment. The double normal has the feature that it allows for domed or logistic selectivity and is a combination of two normal distributions; the first describes the ascending limb, while the second describes the descending limb. A line segment joins the maximum selectivity of the two functions. However, the double normal functional form can be more unstable than other selectivity functions due to the increased number of parameters. When robust length or age compositions are available with sufficient numbers of larger or older fish, it may be appropriate to freely estimate all parameters (especially the descending limb). Unless strong evidence exists for domed selectivity, it is generally advisable to use the logistic function.

In the SEDAR 68 AP Base Model, separate selectivity patterns were defined for each fleet/survey: 1) Commercial Vertical Line (logistic), 2) Commercial Longline (logistic), 3) Recreational Charter Private (double normal), 4) Recreational Headboat (double normal), 5) Combined Video Survey (logistic), and 6) RFOP Vertical Line Survey (logistic).

A logistic selectivity pattern was assumed for both commercial fleets because there was little evidence in the age data suggesting availability issues that might make older fish less vulnerable. This was evident in catch curves developed for each fleet, where the lognormally distributed catch-at-age was regressed against age using the equation (Quinn and Deriso 1999):

$$\ln(C_a) = [\ln(\mu N_f) + fZ] - Z_a$$

where μ is the probability of catching a fish, N_f is the abundance at the start of age a , and Z is the total mortality at age- a . The estimate of Z is the negative of the slope estimated from the linear regression, and its SE is equal to the SE of the slope. The corresponding estimate of survival-at-age (S_a) is $\exp(Z)$. A catch curve typically shows an increasing section of the curve for younger ages, due to increasing availability of fish or selectivity of the gear, followed by a decreasing trend for older ages due to increased mortality stemming from full selectivity by the fishing or survey gear. Steep slopes (e.g., > 1) are generally evidence for dome-shaped selectivity. Catch curves for both commercial fleets showed increases in selection of younger fish, full selection by 9-10 years, and a gradual decline with age characterized by a relatively shallow slope (**Figures 9A-9B**).

Double normal selectivity was implemented for both recreational fleets because dome-shaped selectivity was considered highly likely due to areas fished (e.g., closer to shore, shallower) and targeting behavior. Catch curves for both recreational fleets showed steep increases (>1) in

selection of younger fish, full selection between 3 (Recreational Headboat) and 6 (Recreational Charter Private) years, and a decline with age but lower sample sizes for older fish (**Figures 9C-9D**).

The length-based selectivity patterns of both the pre-IFQ Commercial Vertical Line and the Recreational Headboat CPUE indices were assumed to mirror the selectivity pattern of their respective fleets. Logistic selectivity was assumed for both the Combined Video Survey and the RFOP Vertical Line Survey, since both surveys encountered Scamp throughout their size range.

Selectivity patterns were assumed constant over time for each fleet and survey. The shallow-water grouper fishery has experienced changes in management regulation over time (**Figure 10**), which were assumed to influence the discard patterns more so than selectivity. As such, these changes were accounted for in the assessment model using time-varying retention patterns and modeling discards explicitly.

3.1.8. Retention

Each of the directed fleets was assumed to have regulatory discards based on selection (catch) of fish below the minimum size limit (**Figure 10**). Time-varying retention functions are commonly used in Gulf stock assessments to allow for varying discards at size due to the impacts of fishery minimum size limits and bag limits. For Scamp, time blocks were based on changes in the minimum size limits (federal and the state of Florida) and the implementation of the Grouper-Tilefish Individual Fishing Quota (IFQ) program in 2010.

For each fleet, the retention function was specified as a logistic function consisting of four parameters: (1) the inflection point, (2) the slope, (3) the asymptote, and (4) the male offset inflection (not applicable to this model and assumed to be zero). Before the implementation of the size limit (i.e., pre-1990), all fish caught were assumed to be retained (i.e., landed) for the Commercial Vertical Line, Commercial Longline and Recreational Headboat fleets. Recreational Charter Private discard estimates were provided starting in 1982, which shows that some discarding did occur prior to the implementation of management regulations. Prior to the implementation of the commercial IFQ (pre-2010), all fish above the size limit were assumed to be retained. However, after the implementation of the commercial IFQ, the asymptote parameter was estimated because of potential discarding of fish above the size limit (e.g., due to lack of quota). The asymptotes of the retention function for each time block for both recreational fleets were estimated which allowed for less than 100% retention due to bag limits and other restrictions.

The parameters for the time varying retention blocks for the commercial fleets were treated as:

| Time Block | Inflection | Slope | Asymptote |
|------------|---|-------------------------|------------------|
| pre-1990 | 0 | Fixed at 1 (knife-edge) | Fixed at Maximum |
| 1990-1998 | Fixed at state size limit of 20 inches TL | Estimated | Fixed at Maximum |

| Time Block | Inflection | Slope | Asymptote |
|------------|---|-----------|------------------------|
| 1999-2002 | Estimated (inconsistent federal and state size limits of 16 and 20 inches TL, respectively) | Estimated | Fixed at Maximum |
| 2003-2009 | Fixed at federal and state size limit of 16 inches TL | Estimated | Fixed at Maximum |
| 2010-2017 | Fixed at federal and state size limit of 16 inches TL | Estimated | Estimated (due to IFQ) |

The parameters for the time varying retention blocks for the recreational fleets were treated as:

| Time Block | Inflection | Slope | Asymptote |
|--------------------------|---|---------------------------|------------------|
| Charter Private pre-1990 | Fixed at 31 (peak of retained) | Fixed at 0.5 (knife-edge) | Fixed at Maximum |
| Headboat pre-1990 | 0 | Fixed at 1 (knife-edge) | Fixed at Maximum |
| 1990-1998 | Fixed at state size limit of 20 inches TL | Estimated | Estimated |
| 1999-2002 | Estimated (inconsistent federal and state size limits of 16 and 20 inches TL, respectively) | Estimated | Estimated |
| 2003-2017 | Fixed at federal and state size limit of 16 inches TL | Estimated | Estimated |

3.1.9. Landings and Age Compositions

Landings by fleet and associated length and age compositions were estimated using fleet-specific continuous fishing mortality rates and length-specific selectivity curves following Baranov's catch equation. In the SEDAR 68 AP Base Model, the landings data were assumed to have a lognormal error structure (commercial errors discussed in **Section 2.3.1**). For each recreational fleet and year, the CV provided by the SEDAR 68 DW RecWG for the Recreational Charter Private and Recreational Headboat fleets were converted to a log-scale SE (**Section 2.3.9**). Ultimately, the input SEs for both the Recreational Charter Private and Recreational Headboat fleets were set at 0.3 to reflect greater uncertainty (**Section 4.8.6**).

A new feature available for fitting composition data in SS is the Dirichlet Multinomial (DM) which differs from the standard multinomial in that it included an estimable parameter (theta) which scales the input sample size (Thorson et al. 2017; Methot et al. 2020). The DM is self-weighting, which avoids the potential for subjectivity as when the Francis re-weighting

procedure is applied (Francis 2011). The DM approach also allows for observed zeros in the data, and the effective sample sizes calculated are directly interpretable. The DM uses the input sample sizes directly, adjusted by an estimated variance inflation factor. The more positive the inflation factor, the more weight the data carry in the likelihood. The DM is considered an improved practice and recommended for use by the SS model developers, and was first used in a Gulf stock assessment during SEDAR70 in 2020 for Gulf of Mexico Greater Amberjack. A normal prior was used on the DM parameters of 0 (SD = 1.813), which is recommended to counteract the effect of the logistic transformation between the DM parameter and the data weighting (Methot et al. 2020).

Because SS includes the growth equations directly and models individual fish from birth, it actually grows fish by length bins before eventually converting to age (based on the growth curve). As such, it is possible to fit both age and length composition. For SEDAR 68, the age and length composition data for each fleet/survey were assumed to follow a Dirichlet multinomial error structure where sample size represented the number of trips, adjusted by an estimated variance inflation factor. Input sample sizes are based on the number of trips because using the number of lengths can overestimate sample sizes in fisheries data, as samples are rarely truly random or independent (Hulson et al. 2012). In addition, using higher effective sample sizes can lead to the composition data dominating the likelihood and reduce fit to other data sources. Iterative reweighting is often undertaken in order to adjust the effective sample size to better represent the residual variance between observed and expected values (Methot and Wetzel 2013). The final effective sample sizes for each year are provided on the figures illustrating the age composition and length composition (given by N_{adj} in each panel).

3.1.10. Discards

Discard data for each fleet were directly fit in the SS model using size-based retention functions, and a lognormal error structure was assumed. The model estimated total discards based on the selectivity and retention functions, then calculated dead discards based on the discard mortality rate (**Sections 2.3.3-2.3.4**). Given the research track nature of this assessment, an alternative model configuration which modeled discards as fleets was also evaluated. Briefly, dead discards were input as “landings” for these fleets and length-based selectivity patterns were estimated from the length composition of discarded fish. Ultimately, this configuration was not pursued as a potential base model run because it requires additional selectivity parameters (6 per discard fleet for a total of 24), many of which were poorly estimated ($CV > 1$) and highly correlated. Such an approach may be more useful for more data-rich species that possess ample length and age composition data.

3.1.11. Indices

The indices are assumed to have a lognormal error structure. The CVs provided by the index standardization were converted to a log-scale SE required for input to SS for lognormal error structures (**Section 2.3.9**). The interannual variation in the Combined Video Survey (mean SE = 0.14) and RFOP Vertical Line Survey (mean SE = 0.13) indices was estimated through the index standardization techniques and was used to inform the error around the final observed index values. For the pre-IFQ Commercial Vertical Line and Recreational Headboat CPUE indices (both landings only), the SEs were scaled to a mean SE of 0.2 (*sensu* Francis et al. 2003) across the entire time series, but the relative annual variation was maintained in the scaling. This is a

more appropriate approach than using the output SE from the standardization routine directly in SS because CPUE indices can often have artificially low error estimates.

3.2. Goodness of Fit and Assumed Error Structure

A maximum likelihood approach was used to assess goodness of model fit to each of the data sources (e.g., catch, indices, compositions, etc.). For each separate data set, an assumed error distribution and an associated likelihood component was specified, the value of which was determined by the difference in observed and expected values along with the assumed variance of the error distribution. The total likelihood was the sum of each individual component. A nonlinear iterative search algorithm was used to minimize the total negative log-likelihood across the multidimensional parameter space to determine the parameter values that provide the best fit to the data. With this type of integrated modeling approach, data weighting (i.e., the variance associated with each data set) can affect model results, particularly if the various data sets indicate differing population trends.

In the SS model fitting, iterative reweighting of index variances was applied by adding the SS estimated variance adjustment to the survey input error (i.e., the SD) for each index and then re-running the model and repeated until the estimated new variance adjustment did not change. This commonly requires from one to two iterations.

Weak penalty functions were implemented to keep parameter estimates from hitting their bounds, which includes a symmetric-beta penalty on selectivity parameters (Methot et al. 2020). Parameter bounds were set to be relatively wide and were unlikely to truncate the search algorithm.

Uncertainty in parameter estimates was quantified by computing asymptotic SEs for each parameter. Asymptotic SEs are calculated by inverting the Hessian matrix (i.e., the matrix of second derivatives) after the model fitting process (Methot and Wetzel, 2013). Asymptotic SEs provide a minimum estimate of uncertainty in parameter values.

3.3. Estimated Parameters

In all, 309 parameters were estimated for the SEDAR 68 AP Base Model, of which 220 were active parameters (**Table 10**). These parameters include: year specific (1986-2017) fishing mortality for each fleet, two parameters informing logistic selectivity for the Commercial Vertical Line fleet, the Commercial Longline fleet, the Combined Video Survey, and the RFOP Vertical Line Survey, six parameters informing both Recreational Charter Private and Recreational Headboat selectivities, logistic retention parameters for each fleet, three stock-recruit relationship parameters (the log of virgin recruitment ($\ln(R_0)$), steepness and σR), the stock-recruit deviations for the data-rich time period (1986-2014), the length at the minimum age (L_{Amin}), initial fishing mortality rates for the Commercial Vertical Line, the Commercial Longline, and the Recreational Charter Private fleets, and 10 parameters informing the Dirichlet multinomial length and age composition weightings.

3.4. Model Diagnostics

3.4.1. Residual Analysis

The main approach used to address model fit and performance was residual analysis of model fit to each of the data sets (e.g., catch, indices, length/age compositions, discards). Any temporal trends in model residuals (or trends with age or length for compositional data) can be indicative of model misspecification and poor performance. It is not expected that any model will perfectly fit any of the observed data sets, but ideally, residuals will be randomly distributed and conform to the assumed error structure for that data source. Any extreme patterns of positive or negative residuals are indicative of poor model performance and potential unaccounted for process or observation error.

3.4.2. Correlation Analysis

High correlation among parameters can lead to flat likelihood response surfaces and poor model stability. By performing a correlation analysis, modeling assumptions that lead to inadequate model parameterizations can be highlighted. Because of the highly parameterized nature of stock assessment models, it is expected that some parameters will always be correlated (e.g., stock recruit parameters). However, a large number of extremely correlated parameters warrant reconsideration of modeling assumptions and parametrization. A correlation analysis was carried out and correlations with an absolute value greater than 0.7 were reported.

3.4.3. Profile Likelihoods

Profile likelihoods are used to examine the change in log-likelihood for each data source in order to address the stability of a given parameter estimate, and to see how each individual data source influences the estimate. The analysis is performed by holding the given parameter at a constant value and rerunning the model. This is repeated for a range of reasonable parameter values. Ideally, the graph of likelihood values against parameter values will give a well-defined minimum, indicating that data sources are in agreement. When a given parameter is not well estimated, the profile plot may show conflicting signals across the data sources. The resulting total likelihood surface will often be flat, indicating that multiple parameter values are equally likely given the data. In such instances, the model assumptions need to be reconsidered.

Typically, profiling is carried out for a few key parameters, particularly those defining the stock-recruit relationship. Profiles were carried out for steepness, the log of virgin recruitment, stock-recruit variance, the initial fishing mortality estimates for each fishing fleet, and the von Bertalanffy growth rate parameter (K).

3.4.4. Jitter Analysis

Jitter analysis is a relatively simple method that can be used to assess model stability and to determine whether a global as opposed to local minima has been found by the search algorithm. The premise is that all of the starting values are randomly altered (or ‘jittered’) by an input constant value and the model is rerun from the new starting values. If the resulting population trajectories across a number of runs converge to the same final solution, it can be reasonably assumed that a global minimum has been obtained. This process is not fault-proof and no guarantee can ever be made that the ‘true’ solution has been found or that the model does not

contain misspecification. However, if the jitter analysis results are consistent, it provides additional support that the model is performing well and has come to a stable solution. For this assessment, a jitter value of 0.1 (10%) was applied to the starting values and 100 runs were completed.

3.4.5. Retrospective Analysis

A retrospective analysis is a useful approach for addressing the consistency of terminal year model estimates. The analysis sequentially removes a year of data at a time and reruns the model. If the resulting estimates of derived quantities such as SSB or recruitment differ significantly, particularly if there is serial over- or underestimation of any important quantities, it can indicate that the model has some unidentified process error, and requires reassessing model assumptions. It is expected that removing data will lead to slight differences between the new terminal year estimates and the updated estimates for that year in the model with the full data. Oftentimes additional data, especially compositional data, will improve estimates in years prior to the new terminal year, because the information on cohort strength becomes more reliable. Therefore, slight differences are expected between model runs as more years of data are peeled away. Ideally, the difference in estimates will be slight and more or less randomly distributed above and below the estimates from the model with the complete data sets. A five-year retrospective analysis was carried out for the SEDAR 68 AP Base Model.

3.4.6. Jack-knife Analysis on Indices of Abundance

Another type of data exclusion analysis is the jack-knife approach where individual datasets are removed and the model is rerun with the remaining data. The goal of this analysis was to determine if any single index of abundance was having undue influence on the model and causing tension with other data in terms of estimating parameters. The approach can be especially useful for identifying indices that may be giving conflicting abundance trend signals compared to the other indices. If removing a dataset leads to dramatically different results, it suggests that the dataset should be reexamined to determine if the sampling procedures are consistent and appropriate (e.g., an index may only be sampling a sub-unit of the stock and resulting abundance signals may only reflect a local sub-population and not the trend in the entire stock). For the SEDAR 68 AP Base Model, each index was removed and the model rerun. Additionally, all of the fishery-dependent CPUE indices were removed simultaneously. Other datasets (i.e., landings and compositional data) were deemed fundamentally necessary to stabilize the assessment and therefore their exclusion was not included in the jack-knife analysis.

3.4.7. Sensitivity Runs

Sensitivity runs were conducted with the SEDAR 68 AP Base Model to investigate critical uncertainty in data and reactivity to modeling assumptions. An exhaustive evaluation of model uncertainty was not carried out, but the aspects of model uncertainty judged to be the most important for model performance and accuracy were investigated. Only the most important sensitivity runs are presented below, but many additional exploratory runs were also implemented. The order in which they are presented is not intended to reflect their importance; each run included here provided important information for developing or evaluating the base case model and alternate states of nature. Focus of the sensitivity runs was on population trajectories and important parameter estimates (e.g., recruitment).

Uncertainty in Recreational Landings - Uncertainty surrounding recreational landings was a key discussion point during both the SEDAR 68 DW and AP. Annual CVs for recreational landings by mode were provided for SEDAR 68 but not incorporated into the final SEDAR 68 AP Base Model due to poor model behavior and instability based on model diagnostics. Two sensitivity runs were conducted:

1. *Convert CVs as provided for the Recreational Charter Private and Recreational Headboat fleets into log-scale SE (Table 6B) and use the mean SE for the first five years (1986-1991) as the SE for initial equilibrium catches for each fleet.* This run assumed that the CVs provided for recreational landings in numbers of fish would also be appropriate (and possibly a lower bound) for recreational landings in weight.
2. *Scale CVs as provided for the Recreational Charter Private and Recreational Headboat fleets to a mean of 0.3.* This run maintains the interannual variability in uncertainty estimates for recreational landings in numbers of fish but reduces the overall uncertainty.

Steepness - Steepness is generally one of the most uncertain parameters estimated in a stock assessment model and is a critical quantity to stock assessment. To determine whether steepness was estimable in the SEDAR 68 AP Base Model, we conducted a sensitivity run:

1. *Freely estimate steepness without a prior.* Steepness estimated at a bound can indicate that there is little information in the data about this quantity.

Growth Estimation - In the SEDAR 68 AP Base Model, the only growth parameter estimated was the length at the minimum age, L_{Amin} . One of the benefits of incorporating conditional age-at-length data into SS is it enables the estimation of growth parameters because these data can contain more detailed information about the relationship between size and age. There is a stronger ability of the model to estimate growth parameters, including the variance of size-at-age (Methot et al. 2020). To determine whether the growth parameters were estimable in the SEDAR 68 AP Base Model, we conducted two sensitivity runs:

1. *Estimate K & L_{∞} using a symmetric beta prior ($SD = 0.8$) - use prior values recommended by the SEDAR 68 DW LHWG.*
2. *Estimate K & L_{∞} using symmetric beta prior ($SD = 0.8$) and the CVs for A_{min} and A_{max} . - use prior values for K and L_{∞} and starting values for CV_{Amin} and CV_{Amax} recommended by the SEDAR 68 DW LHWG.*

Natural Mortality (M) - Model sensitivity to the specification of the natural mortality rate was evaluated at the request of the ADT. To explore the impact of natural mortality, with the scaling based on natural mortality derived from different maximum ages, two sensitivity runs were conducted:

1. *Low M - use an M of 0.147 year^{-1} based on a maximum age of 36 years, as recommended by the SEDAR 68 DW LHWG.*
2. *High M - use an M of 0.164 year^{-1} based on a maximum age of 32 years, as recommended by the SEDAR 68 DW LHWG.*

Male Contribution to SSB - In the SEDAR 68 AP Base Model, reproductive potential is measured in the form of male and female combined SSB. Sensitivity runs were recommended by the SEDAR 68 DW LHWG to explore differences in model results given different contributions of males to SSB. Prior discussions have raised concerns over assuming an equivalent importance of male and female SSB (**Section 2.2.6**). The percentages used in the sensitivity runs below were based on fixed intervals given the lack of data and justification for testing values.

1. *0% Male (female only SSB)*. Exclude males from measure of reproductive potential (SSB).
2. *25% Male*. Include 25% of male SSB in the measure of reproductive potential (SSB).
3. *50% Male*. Include 50% of males SSB in the measure of reproductive potential (SSB).
4. *75% Male*. Include 75% of males SSB in the measure of reproductive potential (SSB).

4. Stock Assessment Model - Results

4.1. Estimated Parameters and Derived Quantities

Table 10 contains a summary of model parameters for the SEDAR 68 AP Base Model. Results included are expected parameter values and their associated CVs from SS, minimum and maximum bounds on parameters, and the prior densities assigned to each parameter (if a prior was used). Most parameter estimates and variances were reasonably well estimated (i.e., $CV < 1$). Of the 220 active parameters, 12 exhibited CVs above 1 and were poorly estimated, including eight recruitment deviations, the asymptote of the Recreational Charter Private retention curve for the 1990-1998 and 1999-2002 time blocks, the asymptote of the Recreational Headboat retention curve for the 1990-1998 time block, the parameter defining the ending selectivity for the Recreational Charter Private fleet, and the parameters defining the top and descending limb for the Recreational Headboat fleet. The width of the Recreational Headboat retention curve for the 2003-2009 time block was estimated at 0.199, which was near the lower bound of 0.

4.2. Fishing Mortality

The exploitation rate (total biomass killed age 3+ / total biomass age 3+) for the entire stock and by fleet are provided in **Table 11** and **Figures 11-12**. Since 1986, the exploitation rate for the stock has averaged around 0.096, and ranged between 0.05 in 2011 to 0.145 in 1993 (**Figure 11**). The exploitation rate remained above the time series mean in the 1980s and early 1990s and peaked in 1993. Between 1994 and 2011, the exploitation rate generally remained below the time series mean. The exploitation rate steadily increased until 2016. The terminal year (2017) exploitation rate for the entire stock was 0.109, which is slightly above the time series mean.

Given the relatively recent start for this assessment (1986), all four fishing fleets have been exploiting this stock at varying levels throughout the time series (**Figure 12**). The fishing fleet responsible for the most exploitation overall was the Commercial Vertical Line fleet, for which the exploitation rate has averaged 0.038, and ranged between 0.016 in 2011 (first year of IFQ) to 0.078 in 1992. The exploitation rate for this fleet peaked in 1992 and declined steadily until 2016 where the exploitation rate approached the time series mean (**Figure 12**). The Recreational Charter Private fleet also exhibited relatively high levels of exploitation, which averaged 0.032, and ranged between 0.004 in 1995 to 0.084 in 2015. The trend in the exploitation rate for this

fleet was in clear contrast to the Commercial Vertical Line fleet, with relatively lower values throughout the 1990s and a considerable increase until 2015 where the exploitation rate peaked (**Figure 12**). The Commercial Longline fleet exhibited relatively low but variable levels of exploitation throughout the time series, averaged 0.02, and ranged between 0.011 in 2011 (first year of IFQ) to 0.045 in 1991. Trends in the exploitation rates for the two commercial fleets were similar, with relatively higher values in the 1980s, lower values throughout the mid-1990s and 2000s, and a large increase in 2016 (**Figure 12**). The Recreational Headboat fleet exhibited consistently low levels of exploitation (averaged 0.001), remained near 0 between 2001-2003 and 2005-2007, and peaked at 0.006 in 1989 (**Figure 12**). The terminal year (2017) fishing mortality rates for the Commercial Vertical Line, Commercial Longline, Recreational Charter Private, and Recreational Headboat fleets were 0.025, 0.022, 0.06, and 0.001, respectively (**Table 11**).

The exploitation rate for the stock was driven largely by the commercial fleets in the 1980s and early 1990s, with the exception of 1986 which consisted of high exploitation by the Recreational Charter Private fleet (**Figure 12**). Starting in 2003, the Recreational Charter Private fleet was responsible for the highest exploitation rates for almost all years. Relatively high exploitation of the stock in 2015 was due to increased exploitation by all fleets, and in 2016 was due to increased exploitation by the commercial fleets.

4.3. Selectivity

Scamp were fully selected (> 95%) for at larger sizes for the commercial fleets compared to the recreational fleets (**Figure 13**). Selectivity of both commercial fleets was parametrized using a logistic function, whereas selectivity was allowed to be dome-shaped for the recreational fleets (**Section 3.1.7**). For the Commercial Vertical Line fleet, the size at 50% inflection was estimated around 40 cm FL (CV = 0.009; **Table 10**), with full selection by 51 cm FL (**Figure 13**). The Commercial Longline fleet tended to select for larger Scamp, with the size at 50% inflection of 48 cm FL (CV = 0.007; **Table 10**), and Scamp 60 cm FL or larger fully selected for (**Figure 13**). The Recreational Charter Private fleet tended to select for smaller Scamp (27 cm FL), with selectivity leveling off at 49.7% for Scamp around 60 cm FL or larger (**Figure 13**). However, it is important to note that the parameter defining this ending selectivity had a CV exceeding 1, suggesting it was poorly estimated (**Table 10**). Selectivity by length exhibited the narrowest range for the Recreational Headboat fleet, with Scamp generally selected (i.e., > 50%) between 33 cm FL and 48 cm FL (**Figure 13**). For this fleet, the parameters defining the width of the peak and the descending limb of the selectivity curve had CVs exceeding 1, suggesting these parameters were poorly estimated (**Table 10**).

The selectivity pattern for the Commercial Vertical Line fleet was the only one to reach full selection (i.e., 100%) by age, although the Commercial Longline fleet approached full selection (max = 96.8%; **Figure 14**). The Commercial Vertical Line fleet reached full selectivity around age 12, whereas the Commercial Longline fleet reached full selectivity around age 22. Selectivity for both recreational fleets was highly dome-shaped, with selectivity for the Recreational Charter Private fleet peaking at 95.3% for age 5, and selectivity for the Recreational Headboat fleet peaking at 79% for age 6 (**Figure 14**). The derived age-based selectivity patterns illustrate that the recreational fleets select younger fish, with the Recreational Charter Private and Recreational Headboat fleets generally selecting Scamp 4 years or older and between 4 years and 10, respectively. For comparison, the Commercial Vertical Line and Commercial Longline fleets

generally select for Scamp 6 years and older and 9 years and older, respectively. These results are in agreement with the observed age compositions from the four directed fleets given the increased proportion of younger fish in the recreational fishery.

The SEDAR 68 AP Base Model assumed a logistic selectivity function for the RFOP Vertical Line Survey, which was treated as a survey in SS because it sampled both discarded and retained Scamp and was based on a statistically sound sampling approach. The size at 50% inflection was estimated around 37 cm FL (CV = 0.009; **Table 10**), with full selection above 45 cm FL (**Figure 13**). This translated into 50% selection by 5 years, and full selection by 10 years (**Figure 14**). Compared to the fleet, where selectivity was estimated based solely on retained Scamp, this survey selected for slightly smaller and younger Scamp, as expected, since it included discarded Scamp.

For the SEDAR 68 AP Base Model, selectivity of the Combined Video Survey was parametrized using a logistic function since this survey covers key Scamp habitat and encounters a variety of sized individuals. The size at 50% inflection was estimated around 28 cm FL (CV = 0.015; **Table 10**), with full selection above 36 cm FL (**Figure 13**). This translated into general selection by age 4, and full selection by age 6 (**Figure 14**).

4.4. Retention

All retention parameters for the Commercial Vertical Line fleet appeared well estimated (CV < 1; **Table 10**). Fleet-specific terminal year (2017) selectivity, retention, discard mortality (constant at 0.47) and fraction of fish kept, dead and discarded for the Commercial Vertical Line fleet is shown in **Figure 15A**. All Scamp caught prior to the implementation of regulations (1986-1989) were assumed to be retained and landed (**Figure 15B**). The implementation of the Florida state size limit of 20 inches TL (~47 cm FL) in 1990 shifted the retention curve toward larger Scamp. Inconsistent Florida state (20 inches TL) and federal (16 inches TL; ~38 cm FL) size limits between 1999 and 2002 led to the model estimating an inflection point of 30.697 cm FL, which is much smaller than either size limit (**Table 10**). After the Florida state and federal size limits matched in 2003, the retention curve shifted slightly toward larger Scamp (**Figure 15B**). The retention curves between the pre-IFQ and post-IFQ period were similar, with the post-IFQ period curve reaching an asymptote of 98.4% retention.

All retention parameters for the Commercial Longline fleet appeared well estimated (CV < 1; **Table 10**). Fleet-specific terminal year (2017) selectivity, retention, discard mortality (constant at 0.68) and fraction of fish kept, dead and discarded for the Commercial Longline fleet is shown in **Figure 15C**. All Scamp caught prior to the implementation of regulations (1986-1989) were assumed to be retained and landed (**Figure 15D**). Similar to the Commercial Vertical Line fleet, the retention curve shifted toward larger Scamp following the implementation of the Florida state size limit of 20 inches TL (~47 cm FL) in 1990 (**Figure 15D**). The model estimated an inflection point of 35.659 cm FL (**Table 10**) between 1999 and 2002, just below the federal size limit. After the Florida state and federal size limits matched in 2003, the retention curve shifted to slightly larger Scamp (**Figure 15D**). The retention curves were also similar between the pre-IFQ and post-IFQ periods, with the post-IFQ period curve reaching an asymptote of 99.7% retention.

Most retention parameters for the Recreational Charter Private fleet appeared well estimated (CV < 1), except for the asymptotes for the 1990-1998 and 1999-2002 time blocks (**Table 10**). Fleet-

specific terminal year (2017) selectivity, retention, discard mortality (constant at 0.26) and fraction of fish kept, dead and discarded for the Recreational Charter Private fleet is shown in **Figure 16A**. All Scamp caught above 31 cm FL, which corresponds to the selectivity peak for this fleet, were assumed to be retained and landed prior to the implementation of regulations in 1990 (**Figure 16B**). The implementation of the Florida state size limit of 20 inches TL (~47 cm FL) in 1990 shifted the retention curve toward larger Scamp (**Figure 16B**). Inconsistent Florida state (20 inches TL) and federal (16 inches TL; ~38 cm FL) size limits between 1999 and 2002 led to the model estimating an inflection point of 42.36 cm FL, which falls in between the size limits (**Table 10**). After the Florida state and federal size limit matched in 2003, the retention curve shifted to smaller Scamp at a very steep slope, and reached a maximum retention of 91.9% (**Figure 16B**).

All retention parameters for the Recreational Headboat fleet appeared well estimated ($CV < 1$), except for the asymptote for the 1990-1998 time block (**Table 10**). Fleet-specific terminal year (2017) selectivity, retention, discard mortality (constant at 0.26) and fraction of fish kept, dead and discarded for the Recreational Headboat fleet is shown in **Figure 16C**. All Scamp caught prior to the implementation of regulations (1986-1989) were assumed to be retained and landed (**Figure 16D**). The implementation of the Florida state size limit of 20 inches TL (~47 cm FL) in 1990 shifted the retention curve toward larger Scamp, but at a very gradual slope (**Figure 16D**). Between 1999 and 2002, the model estimated an inflection point of 37.191 cm FL (**Table 10**), which was similar to the federal size limit, and a relatively low maximum retention of 61.5% (**Figure 16D**). After the Florida state and federal size limits matched in 2003, the curve increased sharply to maximum retention of 93.1% (**Figure 16D**).

4.5. Recruitment

The SEDAR 68 AP Base Model estimated a steepness value (CV) of 0.949 (0.041; **Table 10**) using a prior (**Section 3.1.5**), and a σ_R (CV) of 0.356 (0.127; **Table 10**). Virgin recruitment in log-space ($\ln(R_0)$) was estimated at 7.433 (0.003; **Table 10**), which equates to 1.69 million age-0 Scamp.

The highest recruitments estimated by the SEDAR 68 AP Base Model occurred during 2000 (3.2 million age-0 Scamp), 1998 (2.81 million age-0 Scamp), 2002 (2.78 million age-0 Scamp), 1990 (2.5 million age-0 Scamp), and 1992 (2.32 million age-0 Scamp; **Table 12**; **Figures 17-18**). Between 1986 and 2014 (when recruitment deviations were estimated), estimated recruitment averaged 1.69 million Scamp and was lowest in 2012 at 0.83 million Scamp (**Figure 18**). Estimated recruits generally increased throughout the 1980s and 1990s, peaked in 2000, and then declined to below mean levels from 2004 to 2012 (**Figure 18**). Recruitments estimated in 2013 and 2014 were similar to the time series mean. Since recruitment deviations were not estimated between 2015 and 2017, recruitment was fixed at the mean value. Recruitment deviations were consistently above 0 between 1989 through 2003 and below 0 from 2004 to 2012, although the confidence intervals for some years overlapped with 0 (**Figure 19**). The asymptotic SEs for recruitment deviations averaged 0.153 between 1986 and 2014, and ranged from 0.104 in 2009 to 0.245 in 2001 (**Figure 20**).

4.6. Biomass and Abundance Trajectories

The estimated annual total biomass (metric tons), exploitable biomass (ages 3+, metric tons), SSB (metric tons), SSB ratio (SSB/virgin SSB) and exploitable abundance (1,000s of fish) from 1986 to 2017 are provided in **Table 12**. Total biomass averaged 2,218 metric tons, and ranged from 1,658 metric tons in 2017 to 2,861 metric tons in 2007 (**Figure 21**). Exploitable biomass and numbers, which were comprised of Scamp age-3 or older, averaged 2,146 metric tons and 2,179,040 Scamp, respectively. Exploitable biomass was lowest in 2017 at 1,587 metric tons and peaked in 2007 at 2,806 metric tons, whereas exploitable numbers ranged from 1,394,730 Scamp in 2015 to 3,076,169 Scamp in 2005 (**Table 12**). SSB averaged 2,005 metric tons, and ranged from 1,463 metric tons in 2017 to 2,668 metric tons in 2007 (**Figure 22**). Both total biomass and SSB remained relatively low early on in the time series, increased gradually from 1994 until a peaked in 2007, and have since declined (**Figures 21-22**). The SSB ratio averaged 0.51, and ranged from 0.37 in 2017 to 0.68 in 2007 (**Table 12**).

Estimated SSB (metric tons), exploitable biomass (ages 3+, metric tons), and exploitable abundance (1,000s of fish) by sex are provided in **Table 13**. Also included is the expected sex ratio of exploitable male to female Scamp, which averaged 15.1% and ranged from 9.5% in 1995 to 25.4% in 2015 (**Table 13**). The sex ratios expected by the model were lower than those observed in the field, however the general trends were similar, with lower sex ratios expected during the 1990s and higher sex ratios expected in the 2010s. The mean age of female Scamp approached 3 years in the late 1980s and the mid-2000s to 2012, and dropped to around 2 years during the remainder of the time series (**Figure 23A**). The most abundant age class of female Scamp was age-0 in most years, with the exceptions of 1986 and 2003 where age-1 abundance was slightly larger (**Table 14A, Figure 23B**). In contrast, the age classes with the greatest biomass of female Scamp varied between age-4 in 1993 to age-10 in 2012 (**Table 14B; Figure 23C**). Age-6 female Scamp dominated the biomass in many years, including the 1980s and early 1990s (**Figure 23C**). The mean age of male Scamp ranged between 10 years in the mid-1990s to 2000s to nearly 14 years in recent years (**Figure 23A**). The most abundant age class of male Scamp varied between age-6 in 1995 to age-13 in 2013 and 2015, with the plus group (ages-20+) dominating in 2016 and 2017 (**Table 15A, Figure 23D**). The age classes with the greatest biomass of male Scamp varied between age-9 in 1998 and 1999 to age-16 in 2016, with the plus group dominating male Scamp biomass in the early and recent years of the time series (**Table 15B; Figure 23E**).

The expected numbers-at-age and biomass-at-age of female and male Scamp at virgin conditions are shown in **Figure 24**. The sex ratio expected by the model at virgin conditions was 30.7%. At virgin conditions, age-0 and age-7 female Scamp dominated in numbers and biomass, respectively, whereas age 20+ male Scamp were most abundant and dominated biomass (**Figure 24**).

4.7. Model Fit and Residual Analysis

4.7.1. Landings

The landings for the Commercial Vertical Line and Commercial Longline fleets were fit almost exactly given their relatively small SEs (**Tables 16-17, Figure 25**). The mean weight of Scamp landed over time by the Commercial Vertical Line fleet averaged 4.6 gutted pounds and ranged

from 3.9 between 1986 and 1988 (before implementation of size limits; **Figure 10**) to 5.3 in 2015 and 2016 (**Table 16**). The Commercial Longline fleet tended to retain larger Scamp, with the mean weight of landed Scamp over time averaging 5.6 gutted pounds and ranging from 5.1 in 1999 to 6.3 since 2015 (**Table 17**). Given the large SEs assigned to the Recreational Charter Private landings, there were considerable differences between input and expected landings in weights for this fleet (**Table 18, Figure 25**). The model expected much lower landings by the Recreational Charter Private fleet in the mid-1980s, mid-1990s, and around 2005, and expected higher landings around 2004, the late 2000s, and around 2012 (**Figure 25**). The mean weight of Scamp landed over time by the Recreational Charter Private fleet averaged 3.7 gutted pounds and ranged from 2.5 between 1986 and 1989 (before implementation of size limits; **Figure 10**) to 4.2 in the early 1990s and between 2014 and 2016 (**Table 18**). Even though landings for the Recreational Headboat fleet had relatively large SEs, the expected landings were generally similar to the input landings in weights (**Table 19, Figure 25**). The mean weight of Scamp landed over time by the Recreational Headboat fleet was the smallest of the fleets, averaging 3.2 gutted pounds, and ranged from 2.4 between 1986 and 1989 (before implementation of size limits; **Figure 10**) to 4.1 between 2014 and 2016 (**Table 19**).

4.7.2. Discards

Discard data for the Commercial Vertical Line fleet were provided starting in 2000, which is the first full year after the implementation of the federal size limit of 20 inches TL, under the assumption made by the SEDAR 68 DW ComWG that discards were negligible prior to this regulation. Discards were estimated with a large assumed uncertainty (**Table 20**), and therefore were characterized by large confidence intervals (**Figure 26A**). The model fit fairly well to the total discards in many years, although the model expected higher total discards between 2003 and 2007 and 2016 and 2017 (**Figure 26A**). Retention blocks were added to account for state size limit regulations which greatly improved model fits and residuals for length compositions of retained Scamp by this fleet. Between 1990 and 1998, dead discards accounted for more removals (mean: 21% of biomass, 31% of numbers) compared to the more recent time periods (1999+) after the implementation of the federal size limit (2% of biomass, 6% of numbers; **Figure 26B**). Total discards expected by the model averaged 12,747 Scamp (5,991 dead) and peaked at 47,247 Scamp (22,206 dead) in 1997 (**Table 20**). Expected total discard biomass averaged 33,153 gutted pounds (15,582 gutted pounds dead) and peaked at 132,842 gutted pounds (62,435 gutted pounds dead) in 1997 (**Table 20**). The mean body weight of Scamp discarded over time by the Commercial Vertical Line fleet averaged 2.2 gutted pounds and ranged from 1.3 in the mid-2000s to 4.1 in 1989 (**Table 20**).

Discard data for the Commercial Longline fleet were provided starting in 2000, which is the first full year after the implementation of the federal size limit of 20 inches TL, under the assumption made by the SEDAR 68 DW ComWG that discards were negligible prior to this regulation. Discards were estimated with a large assumed uncertainty (**Table 21**), and therefore were characterized by large confidence intervals (**Figure 26C**). The model fit fairly well to the total discards in many years, although the model expected higher total discards between 2003 and 2007 and 2016 (**Figure 26C**). This result was very similar to the trend discussed above for the Commercial Vertical Line fleet. Retention blocks were added to account for state size limit regulations which greatly improved model fits and residuals for length compositions of retained Scamp by this fleet. Between 1990 and 1998, dead discards accounted for more removals (mean:

22% of biomass, 29% of numbers) compared to the more recent time periods (1999+) after the implementation of the federal size limit (1% of biomass, 2% of numbers, **Figure 26D**). Total discards expected by the model averaged 2,918 Scamp (1,984 dead) and peaked at 12,719 Scamp (8,649 dead) in 1991 following the implementation of the Florida size limit (**Table 21**). Expected total discard biomass averaged 10,594 gutted pounds (7,204 gutted pounds dead) and peaked at 52,316 gutted pounds (35,575 gutted pounds dead) in 1991 (**Table 21**). The mean body weight of Scamp discarded over time by the Commercial Longline fleet averaged 2.7 gutted pounds and ranged from 1.1 in the late 1990s and early 2000s to 5.4 in 1989 (**Table 21**).

Discard data provided for the Recreational Charter Private fleet started in 1982 (SEDAR68-DW-09), supporting the discarding of Scamp prior to the implementation of regulations. The total discards for the Recreational Charter Private fleet were highly variable and uncertain, and as a result the model had difficulty fitting in many years (**Figure 27A**). Expected total discards were relatively high in 1993, a few years after the implementation of the Florida state size limit of 20 inches TL in 1990, and in 2002 and 2003, where the Florida state size limit was reduced to be equal to the federal size limit of 16 inches TL implemented in 1999. The model expected higher total discards in the late 1990s but lower discards during some of the 2000s. Compared to landings, dead discards in terms of biomass and numbers accounted for far less removals (mean: 13% of biomass, 28% of numbers; **Figure 27B**). Between 1986 and 2017, expected total discards averaged 42,182 Scamp (10,967 dead) and peaked at 89,572 Scamp (23,289 dead) in 2004 (**Table 22**). Expected total discard biomass averaged 57,218 gutted pounds (14,877 gutted pounds dead) and peaked at 126,617 gutted pounds (32,920 gutted pounds dead) in 1993 (**Table 22**). The mean body weight of Scamp discarded over time by the Recreational Charter Private fleet averaged 1.3 gutted pounds and ranged from 0.7 between 1986 and 1989 to 1.7 in the early 1990s (**Table 22**).

Discard data for the Recreational Headboat fleet were provided starting in 2000, which is the first full year after the implementation of the federal size limit of 16 inches TL, under the assumption made by the SEDAR 68 DW RecWG that discards were negligible prior to this regulation. Retention blocks were implemented that accounted for state size limit regulations but did not substantially improve fits or residuals in the length composition as observed for the commercial fleets. Expected total discards were highest in 2000 after the implementation of the federal size limit of 16 inches TL implemented in 1999 and then in 2015. While the model fit pretty well to total discards early on in the data series, the model expected lower total discards since 2008 (**Figure 27C**). Between 1990 and 1998, dead discards accounted for more removals (mean: 21% of biomass, 28% of numbers) compared to the more recent time periods (1999+) after the implementation of the federal size limit (10% of biomass, 20% of numbers; **Figure 27D**). Between 1986 and 2017, expected total discards averaged 1,219 Scamp (317 dead) and peaked at 3,213 Scamp (835 dead) in 1991 following the implementation of the Florida size limit (**Table 23**). Expected total discard biomass averaged 2,167 pounds (564 pounds dead) and peaked at 6,784 pounds (1,764 pounds dead) in 1991 (**Table 23**). The mean weight of Scamp discarded over time by the Recreational Headboat fleet averaged 1.7 pounds and ranged from 1.3 in 2017 to 2.3 in 1986 (**Table 23**).

4.7.3. Indices

Observed and expected CPUE are provided in **Tables 24-25** and **Figure 28A-D**. The model fit best to the Recreational Headboat index (root mean squared error [RMSE] = 0.287, variance

adjustment recommended of 0.087). This index exhibited a relatively low correlation of 0.26 with the expected SSB. For this index, expected relative abundance remained high in the mid 1980s, dropped below mean levels for most of the 1990s and early 2000s, increased until peaking in 2007, and then declined to the lowest value in 2017 (**Figure 28B**). The model also fit the Combined Video Survey index fairly well (RMSE = 0.311, variance adjustment recommended of 0.156). This index exhibited the highest correlation of 0.66 with the expected SSB. Expected relative abundance from this survey increased until 2005, declined to the lowest value in 2016, and increased slightly in 2017 but remained below the time series mean (**Figure 28C**). The model did not fit very well to the RFOP Vertical Line Survey index (RMSE = 0.404, variance adjustment recommended of 0.238) or the pre-IFQ Commercial Vertical Line index (RMSE = 0.472, variance adjustment recommended of 0.249). Both of these indices were relatively flat throughout the time series and exhibited little contrast (**Figure 28A,D**) and were poorly correlated with the expected SSB (pre-IFQ ComVL = -0.11; RFOP VL = -0.46). Expected relative abundance for the RFOP Vertical Line Survey was highest in 2007 and declined to the lowest value in 2017 (**Figure 28D**). Expected relative abundance from the pre-IFQ Commercial Vertical Line index was relatively low between 1993 and 1998, increased sharply to 1999, and then increased gradually until peaking in 2008 (**Figure 28A**).

4.7.4. Length Compositions

Overall, the quality of the model fit to observed length data varied among the fleets and surveys (**Figures 29-32**), as well as between retained and discarded length compositions within fleets. Aggregated across years, the expected length compositions were similar to the observed compositions for most fleets and surveys (**Figure 33**). Fits to retained length compositions were often better than to discarded length compositions for each fleet, although sample sizes were notable smaller for discard length compositions (discussed below).

Annual fits to retained length compositions for the Commercial Vertical Line fleet were generally good, with expected and observed peaks similarly around 40 cm FL in most years (**Figure 29A**). However, some early years exhibited small sample sizes and therefore jagged compositions with peaks not similar between observed and expected compositions. Although the Pearson residuals were relatively small (min = -2.69, max = 3.83), some patterns were evident such as observing more Scamp (large positive residuals) just below the size limits in the late 1990s and from 2003 to 2013. For the annual discarded length compositions, the model generally expected peak composition in agreement with the data of Scamp just under 40 cm FL. While sample sizes were relatively low for the discarded compositions, Pearson residuals did not show any concerning magnitudes (min = -1.51, max = 2.6) or patterns (**Figure 29B**). The estimated Dirichlet parameter of 5.74 did not result in very different sample sizes from the inputs, suggested that input sample sizes were appropriate (**Table 10**).

Annual fits to retained length compositions for the Commercial Longline fleet were also generally good, with both expected and observed peaks around 45 cm FL in almost all years except 1986 (**Figure 29C**). Although the Pearson residuals were relatively small (min = -1.51, max = 3.93), some patterns were evident with clusters of more observed Scamp around 60 cm FL in the 1990s and mid- to late-2000s. Given limited sample sizes in most years, only a few years of discarded length compositions were fit by the model and showed good agreement between expected and observed peaks just below 40 cm FL but poor correspondence for smaller Scamp (**Figure 29D**). Residuals did not reveal any concerning magnitudes (min = -1.49, max = 2.19) or

strong patterns. The estimated Dirichlet parameter of 5.77 did not result in very different sample sizes from the inputs, suggested that input sample sizes were appropriate (**Table 10**).

Annual fits to retained length compositions for the Recreational Charter Private fleet showed more variability in quality, with some years exhibiting good fits, such as 1999 through 2007, but others showing poor correspondence and jagged compositions (e.g., 2008 through 2017; **Figure 30A**). The Pearson residuals were relatively large (min = -2.71, max = 7.15) and showed some patterning. For example, more observed Scamp (larger positive residuals) were evident around 30 cm in 2010 and then increased in size over time. For the annual discarded length compositions, the model generally expected peak composition in agreement with the data of Scamp around 30 cm FL but sometimes at lower magnitude (**Figure 30B**). Residuals did not reveal any concerning magnitudes (min = -1.94, max = 3.16) or patterns. The estimated Dirichlet parameter of 5.56 did not result in very different sample sizes from the inputs, suggested that input sample sizes were appropriate (**Table 10**).

Annual fits to retained length compositions for the Recreational Headboat fleet also showed more variability in quality and very variable sample sizes between years (**Figure 30C**). Many years exhibited good agreement between expected and observed peaks in composition while the most recent years showed poor correspondence. The Pearson residuals were also relatively large (min = -2.62, max = 11.32) and showed some patterns, with more observed Scamp (larger positive residuals) below the size limit during the 2000s. For the annual discarded length compositions, the model generally expected peak composition close to but slightly larger than the peak observed (**Figure 30D**). Residuals did not reveal any concerning magnitudes (min = -1.69, max = 4.53) or patterns. The estimated Dirichlet parameter of 5.5 did not result in very different sample sizes from the inputs, suggested that input sample sizes were appropriate (**Table 10**).

Annual fits to length compositions for the Combined Video Survey showed more variability in quality and very variable sample sizes between years (**Figure 31**). The early years exhibited good agreement between expected and observed peaks in composition whereas years such as 2008 and 2009 showed poor correspondence. The Pearson residuals were relatively small (min = -1.86, max = 3.73) and didn't showed any major patterns. The estimated Dirichlet parameter of 5.06 did not result in very different sample sizes from the inputs, suggested that input sample sizes were appropriate (**Table 10**).

Annual fits to length compositions for the RFOP Vertical Line Survey showed considerable variability in terms of agreement between observed and expected compositions (**Figure 32**). While some years showed good agreement of peak composition around 40 cm FL (e.g., 2007, 2012-2013, 2016), the model expected smaller compositions in 2008 and 2017 but larger composition in 2010. The Pearson residuals were relatively large (min = -3.4, max = 5.33) but did not show any strong patterns. The estimated Dirichlet parameter of -1.45 resulted in very different sample sizes, suggested that input sample sizes were too large (**Table 10**).

4.7.5. Age Compositions

Overall, the quality of the model fits to observed age compositions and mean age varied among the fleets and surveys (**Figures 34-37**). Aggregated across years, the model expected older Scamp compared to those observed for both recreational fleets, resulting in poor overall fits to

the age compositions (**Figure 38**). Clearly, for these fleets there was a trade-off in fitting either the weighted length compositions or the nominal age compositions (discussed further in **Section 4.8.2**).

The model fits to the conditional age-at-length age composition samples for the Commercial Vertical Line fleet are shown in **Figure 34A**. The conditional age composition fits represent the estimates of age composition within length intervals (bins) and in many cases the number of age observations within a bin interval was very low adding difficulty to the fitting process. Input sample sizes averaged 18 Scamp and ranged from 1 to 101, with 56% of observations having fewer than 10 Scamp. The estimated Dirichlet parameter of 5.47 resulted in similar sample sizes (DM adjusted mean = 18 fish, range: 1-101), suggesting that input sample sizes were appropriate (**Table 10**). Differences in observed and expected mean age were variable for the Commercial Vertical Line fleet, with expected mean age ranging between 7 and 11 years and the observed mean age varying between 6 and 11 years (**Figure 34B**). The expected mean age remained within the 95% confidence intervals for about half of the years, with the exception of 1991-1992, 1995, 2001-2002, 2011-2014, and 2017. Evaluation of the mean age-at-length and SD by size class revealed fairly good agreement between expected and observed values for most years, as evident by expected values remaining between the 90% confidence intervals (**Figure 34C**). Most years revealed good agreement between observed and expected mean length-at-age, with some years displaying fairly variable observed mean length-at-age due to lower sample sizes (**Figure 34D**). Pearson residuals for the mean length-at-age showed some underestimation of younger Scamp in many years (**Figure 34E**).

The model fits to the conditional age-at-length age composition samples for the Commercial Longline fleet are shown in **Figure 35A**. As discussed above, the number of age observations within a bin interval was very low adding difficulty to the fitting process, as input sample sizes averaged 24 Scamp and ranged from 1 to 169, with 46% of observations having fewer than 10 Scamp. The estimated Dirichlet parameter of 4.88 resulted in similar sample sizes (DM adjusted mean = 23.41 fish, range: 1-168), suggesting that input sample sizes were appropriate (**Table 10**). Differences in observed and expected mean age were variable for the Commercial Longline fleet, with expected mean age ranging between 9 and 11 years and the observed mean age varying between 8 and 12 years (**Figure 35B**). The expected mean age often fell outside the 95% confidence intervals for earlier years, and remained within the confidence intervals more often in recent years. Evaluation of the mean age-at-length and SD by size class revealed fairly good agreement between expected and observed values for most years, as evident by expected values remaining between the 90% confidence intervals (**Figure 35C**). Most years also revealed good agreement between observed and expected mean length-at-age (**Figure 35D**). Pearson residuals for the mean length-at-age showed some underestimation of younger Scamp in recent years and older ages throughout the 2000s (**Figure 35E**).

Annual fits to nominal age compositions for the Recreational Charter Private fleet showed considerable variability and often poor agreement between observed and expected compositions (**Figure 36A**). Because of relatively low input sample sizes (mean = 27 trips, range: 10-89), the distributions of ages each year are irregular and jagged. While some years showed good agreement of peak composition around 5 years (e.g., 1994-1997, 2005), the model tended to expect more older Scamp. The Pearson residuals showed a severe underestimation of younger Scamp in the last five years (min = -1.98, max = 23.24). The estimated Dirichlet parameter of 0.82 resulted in considerably lower sample sizes (DM adjusted mean = 19 trips, range: 7.26-

62.18), suggesting that input sample sizes were too large (**Table 10**). While differences in observed and expected mean age were evident, with expected mean age ranging between 7 and 9 years and the observed mean age varying between 5 and 8 years, the expected mean age remained within the 95% confidence intervals for most years until 2011 (**Figure 36B**). There was a clear disconnect in more recent years (potentially due to regulations for other species that co-occur with Scamp), where the observed mean age ranged between 5 and 8 years while the mean age of expected Scamp averaged about 9 years.

Annual fits to nominal age compositions for the Recreational Headboat fleet also showed considerable variability and often poor agreement between observed and expected compositions (**Figure 37A**). Because of relatively low input sample sizes (mean = 27 trips, range: 10-50), the distributions of ages each year are irregular and jagged. Only a few years showed good agreement of peak composition around 5 years (e.g., 2013), with the model consistently expecting more older Scamp, as observed above for the Recreational Charter Private fleet. The Pearson residuals showed a severe underestimation of younger Scamp in all years (min = -1.98, max = 16.78). The estimated Dirichlet parameter of 0.51 resulted in considerably lower sample sizes (DM adjusted mean = 17.14 trips, range: 6.63-31.66), suggesting that input sample sizes were too large (**Table 10**). Differences in observed and expected mean age were more evident and variable for the Recreational Headboat fleet, with expected mean age ranging between 6 and 9 years and the observed mean age varying between 4 and 9 years (**Figure 37B**). The expected mean age remained within the 95% confidence intervals for many years, with the exception of 1992-1994, 1996-1997, and 2015.

4.8. Model Diagnostics

4.8.1. Correlation Analysis

The SEDAR 68 AP Base Model does not include any fixed selectivity parameters, although some retention parameters were fixed as described in **Section 3.1.8** and **Table 10**. Further, no priors were placed on any selectivity or retention parameters. Given the highly parametrized nature of this model, some parameters were mildly correlated (correlation coefficient > 70%) and one combination displayed a strong correlation (> 95%; **Table 26**). Correlation among many of these parameters is not surprising, especially for the selectivity parameters, because the parameters of selectivity functions are inherently correlated (i.e., as the value of one parameter changes the other value will compensate). Moderate correlations occurred between the parameters defining the peak and the width of the ascending limb of the double normal selectivity functions for both recreational fleets. Unique to the Recreational Headboat fleet, the parameter defining the width of the plateau of the double normal selectivity function was very strongly correlated with the parameter defining the width of the descending limb. The parameters defining the inflection point and width of the retention curve in the 1999-2002 time block were moderately correlated for both the Commercial Vertical Line and Recreational Charter Private fleets. Lastly, recruitment deviations between 2000 and 2003 demonstrated moderate correlations.

4.8.2. Profile Likelihoods

The total likelihood component from the $\text{Ln}(R_0)$ likelihood profile indicates that the global solution for this parameter is approximately 7.45 (**Figure 39A**). The SEDAR 68 AP Base Model

estimating $\text{Ln}(R_0)$ at 7.433 (CV = 0.003; **Table 10**). Other $\text{Ln}(R_0)$ values which remained within 2 negative log-likelihood units included: 7.4. Almost all data sources supported this estimate, with the exception of the discard data which showed a lower minimum near 7.3 and recruitment which showed a minimum around 7.7.

The total likelihood component from the steepness likelihood profile (using a prior) supported a minimum around 0.94 (**Figure 39B**), which corresponded well with the SEDAR 68 AP Base Model estimate of 0.949 (CV = 0.041; **Table 10**). However, a wide range of steepness values from 0.84 through 0.98 remained within 2 negative log-likelihood units. Minima by data source ranged from 0.7 for equilibrium catch and parameter priors to 0.99 for the remaining data sources. In the absence of a prior on steepness, the global solution for the steepness likelihood profile is 0.99, with values between 0.91 and 0.98 within 2 negative log-likelihood units, but most data sources supporting 0.99 (**Figure 39C**).

The total likelihood component from the σR likelihood profile indicates that the global solution for this parameter is approximately 0.34 (**Figure 39D**), with the SEDAR 68 AP Base Model estimating σR at 0.356 (CV = 0.127; **Table 10**). However, values between 0.28 and 0.46 remained within 2 negative log-likelihood units. While most data sources supported values around the total minimum, minima by data source ranged from 0.2 for catch and index data to 0.6 for equilibrium catch data.

The total likelihood component from the initial fishing mortality rate likelihood profile for the Commercial Vertical Line fleet indicates that the global solution for this parameter is approximately 0.06 (**Figure 39E**), with the SEDAR 68 AP Base Model estimating the initial F at 0.056 (CV = 0.071; **Table 10**). Other values which remained within 2 negative log-likelihood units included 0.05. Most data sources showed minima close to the model estimate, with the exception of the discards data and recruitment which supported higher estimates around 1.0.

The total likelihood component from the initial fishing mortality rate likelihood profile for the Commercial Longline fleet supported a minimum around 0.06 (**Figure 39F**), which corresponds well with the SEDAR 68 AP Base Model estimating the initial F at 0.062 (CV = 0.078; **Table 10**). Other values which remained within 2 negative log-likelihood units included 0.07. Most data sources showed minima close to the model estimate, with the exception of the discards data which supported higher estimates around 0.1 and the index data and recruitment which supported lower estimates between 0.02 and 0.03.

The total likelihood component from the initial fishing mortality likelihood profile for the Recreational Charter Private fleet indicates that the global solution for this parameter is approximately 0.05 (**Figure 39G**), with the SEDAR 68 AP Base Model estimating the initial F at 0.051 (CV = 0.068; **Table 10**). No other values remained within 2 negative log-likelihood units. Many of the data sources showed minima close to the model estimate, with the exception of the discard and age data which supported estimates between 0.08 and 1.0 and the index data which supported lower estimates around 0.03.

The likelihood profile for the von Bertalanffy growth rate parameter revealed considerable conflict between data sources. The total likelihood component indicates that the global solution for this parameter is approximately 0.05 (**Figure 39H**). No other values remained within 2 negative log-likelihood units. While the length data supported values around 0.12, the age data supported lower values around 0.085.

4.8.3. Jitter Analysis

A jitter analysis was conducted using a jitter value of 0.1. With this procedure, the starting model parameter values are randomly adjusted by 10% from the SEDAR 68 AP Base Model best fit. The model converged to the same likelihood of the SEDAR 68 AP Base Model in 9% of runs, remained within 5 NLL units for 34% of runs, and remained within 50 units for 58% of runs. No runs demonstrated a lower negative log-likelihood solution (**Figure 40A**). It is important to note that these results are a result of the flexibility allowed in the SEDAR 68 AP Base Model and the large number of parameters estimated freely, including all selectivity and some retention parameters (**Table 10**). In instances where the base solution was not reached or approached, the length and/or age data were often disproportionately dominating the total negative log-likelihood. Most likely this was due to difficulties estimating selectivity or retention for the recreational fleets. Given that the total negative log-likelihood values were much higher for some runs, it is probable that non-optimal solutions were found (i.e., the model search was stuck in local minima). Given the similarity in recruitment parameter estimates (**Figure 40B**) and the relative agreement in estimated trajectories for SSB, recruitment, and exploitation rate (**Figure 40C**), the jitter analysis indicates that the model results are relatively consistent. If problematic parameters (i.e., $CV > 1$) had been fixed or priors had been placed on them, it is likely that a higher percentage of jitter runs would have converged back to the base solution. However, the ADT supported the approach taken because fixing parameters (with high uncertainty) can give a false sense of model stability. Further, Scamp are not as data-rich as primary targeted groupers, so greater uncertainty in model parameters can be expected given data quantity and quality.

4.8.4. Retrospective Analysis

Results of the retrospectives illustrate a fairly consistent trend estimated within the SEDAR 68 AP Base Model. As the first few years of data are peeled off, the model estimates of SSB and F in each successive terminal year do not change by a large margin (and remain within the confidence intervals; **Figure 41**). While the remaining terminal years show some pathological trend of underestimation in SSB and an overestimation of F , this can be attributed to the estimation of recruitment deviations ending in 2014. Recruitment estimates, particularly in years where recruitment deviations were estimated, are more variable as more years of data are peeled off. The model is missing key composition data inputs that capture those cohorts moving through the fishery.

4.8.5. Jack-knife Analysis on Indices of Abundance

The removal of one index at a time and all fishery-independent indices at one time indicated that no one index or group of indices appeared to be having undue influence on estimates of key derived quantities (**Table 27**), although some years revealed some minor sensitivity to index removal (**Figure 42**). Estimates of steepness varied between 0.94 and 0.95 (base = 0.949 ($CV = 0.041$)), estimates of σR ranged between 0.334 and 0.369 (base = 0.356 ($CV = 0.127$)), and estimates of $\ln(R_0)$ ranged from 7.434 to 7.489 (base = 7.433 ($CV = 0.003$)). The removal of the headboat index and all fishery-dependent indices led to higher virgin SSB and recruitment (**Table 27**) and higher SSB and recruitment in the first decade and in more recent years (**Figure 42**). The removal of these indices resulted in more variable F in the earlier years, with the exclusion of the headboat index resulting in lower F in more recent years. Although these small differences were noted, the resulting trends generally remained within the uncertainty intervals.

4.8.6. Sensitivity Model Runs

Results for the five sensitivity runs summarized in **Section 3.4.7** are presented in **Table 27** and discussed below.

Uncertainty in Recreational Landings

Overall, the trends in estimated SSB and recruitment were very similar across the uncertainty scenarios using the errors provided by the data providers and the errors scaled to a mean error of 0.3 (**Figure 43**). Differences in F were evident due to the greater uncertainty, and therefore added flexibility of the model to fit (or not fit) to recreational landings. Estimates of steepness, σR and estimates of $\text{Ln}(R_0)$ were very similar to the estimates from the SEDAR 68 AP Base Model (**Table 27**).

Steepness

In the absence of an informative prior, steepness was estimated at the upper bound of 0.99 (**Table 27**). Estimated quantities were nearly identical, as were trends and the magnitude (and uncertainty) in virgin SSB, annual SSB, recruitment, and F (**Figure 44**). The likelihood profile of the steepness parameter from the SEDAR 68 AP Base Model without a prior revealed agreement between almost all data sources supporting an estimate of 0.99 (**Figure 39C**). Ultimately, these results suggest that the data contained very little information to freely estimate steepness.

Growth Estimation

The sensitivity run estimating L_∞ and K , in addition to L_{Amin} as in the SEDAR 68 AP Base Model, led to estimates of $L_{Amin} = 23.145$ (CV = 0.011) cm FL (base = 10.19 cm FL); $L_\infty = 93.488$ (CV = 0.019) cm FL (base = 70.22 cm FL); and $K = 0.053$ (CV = 0.04) year⁻¹ (base = 0.134 year⁻¹). The sensitivity run estimating all five growth parameters led to similar estimates of $L_{Amin} = 22.648$ (CV = 0.015) cm FL; $L_\infty = 93.914$ (CV = 0.021) cm FL; $K = 0.053$ (CV = 0.043) year⁻¹; and estimates of $CV_{Amin} = 0.138$ (CV = 0.029) cm FL (base = 0.13); and $CV_{Amax} = 0.105$ (CV = 0.073) cm FL (base = 0.13). Both sensitivity runs estimated larger fish at age-1 (L_{Amin}), much larger asymptotic sizes (L_∞), and much slower growth rates (K). It is important to note that these estimates of L_∞ and K did not fall within the uncertainty range of parameter estimates provided by the Life History Working Group (Table 9 in DW Report). In addition, very few Scamp larger than 80 cm FL were observed in the data submitted for SEDAR 68. Compared to the recommended constant CV of 0.13, the variability in size-at-age estimated for A_{min} was slightly higher whereas the variability in size-at-age estimated for A_{max} was lower. Although the growth curve recommended by the SEDAR 68 DW LHWG falls within the 95% distribution of length-at-age around estimated growth curve (**Figure 45**), the ADT supported fixing most of the growth parameter estimates for the reasons discussed above.

When estimating the growth parameters, the assessment expected smaller Scamp at size for Scamp up to about 17 years (**Figure 45**), which led to lower estimated SSB and higher F throughout the time series (**Figure 46**). Annual recruitment estimates differed in some years, but generally fell within the confidence intervals of the base estimates. Both sensitivity runs resulted in much lower negative log-likelihood estimates (**Table 27**) due to better fits to the conditional age-at-length compositions for both commercial fleets and the age compositions for both

recreational fleets. The likelihood profile of the K parameter from the SEDAR 68 AP Base Model identified clear trade-offs in fits to the length and age compositions (**Section 4.8.2**).

Natural mortality

Differences in estimated quantities followed expected patterns under both the high and low M scenarios, with the SEDAR 68 AP Base Model estimates falling between estimates for these scenarios (**Figure 47**). The high M scenario led to higher annual estimates of SSB, greater annual recruitments, and lower annual F rates across the time series. The low M scenario led to lower annual estimates of SSB, smaller annual recruitments, and higher annual F rates across the time series. Estimates of steepness and σR were similar to the base estimates, and varied between 0.94 and 0.95 (base = 0.949 (CV = 0.041)) and 0.351 to 0.362 (base = 0.356 (CV = 0.127)), respectively (**Table 27**). The high M scenario resulted in a slightly higher estimate of $\ln(R_0)$ of 7.592 compared to the base estimate of 7.433 (CV = 0.003) and the low M scenario estimate of 7.293 (**Table 27**).

Contribution of Male SSB

As expected, the magnitude of both virgin and annual SSB estimates declined as the contribution of male SSB decreased from 100% in the SEDAR 68 AP Base Model to 0% (i.e., a female-only SSB model; **Figure 48**). No differences in virgin or annual recruitment or annual estimates of F were evident across these scenarios. While estimates of σR and $\ln(R_0)$ were nearly identical across runs (**Table 27**), the estimates of steepness declined slightly across scenarios from 0.949 (0.041) in the SEDAR 68 AP Base Model (i.e., 100% contribution of males) to 0.898 for the female-only SSB run.

5. Discussion

Gulf of Mexico Scamp experienced the highest fishing mortality in the 1980s and early 1990s, and again in more recent years. The commercial fisheries were responsible for much of the mortality in the 1980s and early 1990s, although occasional spikes were evident for the Recreational Charter Private fishery. The stock also experienced relatively high F in 2015 and 2016 due to spikes in F for all four fleets, potentially due to increased targeting or pressure stemming from an inability to reach quotas for more desirable Gag and Red Grouper. While landings were predominantly commercial early on in the time series, landings have shifted more toward the Recreational Charter Private fleet in recent years. Overall, dead discards for all four fleets have remained only a minor contribution to total removals throughout the time series, with the SEDAR 68 AP Base Model supporting a greater proportion of dead discards in the 1990 to 1998 time block for each fleet based on improved fits to length compositions.

Spawning stock biomass started out at relatively low values in the 1980s, increased gradually from 1994 until 2007, and has declined to record low values in 2017. Composition data in combination with large recruitment events (1990, 1992, 1998, 2000, and 2002) largely drove the increase in SSB. The recent decline in Scamp SSB, as well as observed declines in both the Combined Video Survey and Recreational Headboat indices, is likely tied to changes in more desirable and targeted species such as Gag and Red Grouper. Red tide mortality was not considered a substantial removal of Scamp given their prevalence at deeper depths than more shallow-water groupers. The ratio of current SSB to virgin SSB is about 37%.

Stock status for Gulf of Mexico Scamp will be finalized during the upcoming Operational Assessment. MSY-based reference points could be supported by the results because an informative prior on steepness was used, which informed the stock-recruit relationship. However, given the concerns over the ability of the model to estimate steepness (e.g., wide range identified in the likelihood profile), and the resulting stock-recruit relationship which appears uninformative, it may be more appropriate to use proxy reference points using spawning potential ratio (SPR). Simulations conducted by Harford et al. (2019) suggest that SPR ratios of 40% or 50% led to the highest probabilities of achieving long-term MSY for hermaphroditic stocks. They found that more conservative fishing mortality proxies were required to achieve MSY-based fishery objectives when steepness was “least certain” (i.e., uniform prior). Additional simulation work is needed to evaluate how reference points could be affected by management, ecosystem, climate, species interactions, habitat considerations, and/or episodic events.

The SEDAR 68 AP Base Model fit most of the data sources well with no major residual patterns, although trade-offs between fitting to the recreational length and age compositions were evident. Additional investigations are ongoing (e.g., re-evaluate conditional age-at-length) into this issue. The dominant data inputs were the length and age compositions as these produced the greatest impact on the model fit (as measured in the total likelihood). While many of the commercial and recreational data streams did not reveal very large residuals in terms of magnitude, some patterns in residuals noted likely relate to regulations for species other than Scamp. The conceptual map of Scamp dynamics in the Gulf of Mexico, along with the stakeholder input and hypotheses posed from this pilot project, emphasized the non-target nature of fishing for Scamp and how regulations for other species could affect Scamp (SEDAR68-AW-02). This assessment, as well as other Gulf of Mexico assessments, would greatly benefit from a clear understanding of changes in management regulations for other species (e.g., groupers, Red snapper) that fall within the multi-species fisheries in the Gulf of Mexico.

Overall, the SEDAR 68 AP Base Model appears to perform fairly well. Some conflicts in model fits were noted, particularly for the recreational age and length data. While some parameters exhibited CVs exceeding 1 and moderate correlations, in general the model diagnostics were acceptable. Although the jitter analysis revealed many runs with higher negative log-likelihood estimates than the SEDAR 68 AP Base Model, the trends and estimates of key derived quantities were similar and did not suggest an alternative model solution. The current model structure, which includes many freely estimated retention and selectivity parameters, was largely responsible for jitter results. Many runs came to different negative log-likelihood solutions due to differences in fits to either length or age compositions for the recreational fleets. Both of these fleets exhibited selectivity and retention parameters with CVs exceeding 1 or moderate correlations (>0.7). Rather than fix these parameters or give them priors to force them to remain stable, we maintained the current configuration to better illustrate these uncertainties and the impact on model results. Profile likelihood analyses provided support for the SEDAR 68 AP Base Model estimates of key recruitment parameters and initial fishing mortality parameters. Sensitivity analyses focused on uncertainty in recreational landings, the use of a prior when estimating steepness, and removal of indices of abundance (separately or all fishery-dependent indices simultaneously) revealed no major differences in key estimated quantities of SSB and recruitment. Other sensitivity analyses, focused on high and low natural mortality scenarios and

contribution of male SSB scenarios, helped to highlight the potential influence of these assumptions on the model outcome, with differences in results conforming to expectations.

This first Research Track stock assessment for Gulf of Mexico Scamp tested and implemented a number of new or improved procedures and methodologies including: revamped natural mortality estimation by revising the Then et al. (2015) approach using a subset of the data relevant to the species under assessment; implemented the updated Hermaphroditism function in SS which allows the specification of the first age that undergoes sexual transition; tested different contributions of male SSB to the reproductive potential of the stock; inputted recreational landings in gutted weight instead of numbers of fish and incorporated annual error estimates for commercial and recreational landings that varied over time; utilized the Dirichlet-multinomial error distribution for composition data (Thorson et al. 2017); and developed and incorporated a novel index of relative abundance from the RFOP. Many of these improvements may become standardized best practices for future Gulf assessments.

A key uncertainty for the Gulf of Mexico Scamp stock assessment and most assessment models in general, is the stock-recruitment relationship. Ultimately, the SEDAR 68 ADT supported the estimation of steepness using an informative prior in the SEDAR 68 AP Base Model following review of model diagnostics. While some discussion centered around the stock-recruitment relationship for the Scamp-Yellowmouth Grouper complex, the SEDAR 68 ADT supported this application because of the overwhelming dominance of Scamp throughout each data stream (see SEDAR 2016 for a thorough review of data available for Yellowmouth Grouper). Some previous Gulf of Mexico assessments have maintained the assumption of a steepness value of 0.99 to allow projections assuming recent mean recruitment. For example, this decision was made for Gulf of Mexico Red Grouper by the SEDAR42 Review Panel based on an uninformative stock recruitment relationship, in addition to general consensus that the “estimated steepness of 0.8 was low compared to other comparable fish stocks (around 0.9 would be more in line with other similar stocks)” (SEDAR 2015). The SEDAR 68 ADT thought that the steepness estimate from the SEDAR 68 AP Base Model was realistic. The constant recruitment approach for projections is not necessarily ideal because it eliminates the dependency of recruitment on spawners, which implies that recruitment never falters even at extremely low stock sizes (i.e., recruitment overfishing is not possible).

Stock assessments of protogynous stocks typically model reproductive potential in the form of male and female combined SSB (Shepherd et al. 2013). Brooks et al. (2008) explored via simulation various SSB approaches and stock assessment performance given uncertainties regarding loss of males and reduced fertility. They concluded that SSB-combined is best when the potential for decreased fertility is moderate or unknown. While the percentage of males is relatively high for Gulf of Mexico (range from literature reviewed in SEDAR68-DW-28: 18-41%) compared to other groupers (e.g., Gag Grouper, 3%; SEDAR 2014), this decision by the SEDAR 68 DW was based largely on data limitations. Additional research is needed to better understand the reproductive biology of Scamp and to explore how both protogyny and harem breeding would affect stock status and reproductive potential under conditions of (i) low population density, and (ii) disproportionate sex ratios. Such an analysis would be informative in assisting the assessment of such population properties as recovery times and would assist managers to understand changing uncertainties at low stock densities or unusual sex ratios for hermaphroditic stocks such as Scamp.

6. Acknowledgements

The SEDAR 68 Research Track for Gulf of Mexico Scamp would not have been possible without the efforts of the numerous NMFS, SEFSC, SERO, and GMFMC staff along with the many academic and research partners involved throughout the Gulf of Mexico and South Atlantic listed in **Section 1.1.3**. Special thanks are also extended to the workgroup leads, the Assessment Development Team members, and Dr. Richard Methot and his team for continued discussions and modifications to the SS model.

7. Research Recommendations

Recommendations for considerations of future research are provided below and do not indicate any particular order of priority.

Age and Growth

- Investigate methods to better collect age structure samples randomly and systematically from all fishing sectors, especially the recreational sector
- Continue collaboration with ageing facilities throughout the Gulf of Mexico and South Atlantic.

Natural Mortality

- Explore more direct approaches to estimating natural mortality (e.g., Mark-recapture approaches (conventional, telemetry, or close-kin))

Discard Mortality

- Continue data collection from observer or electronic monitoring programs (e.g., SEDAR68-DW-22)
- Develop discard mortality rates for recreational fishery by mode

Reproduction

- Continue data collection for maturity, sex transition, and fecundity as detailed in the DW Report Recommendations

Landings and Discards

- Explore approaches for assigning uncertainty estimates to commercial and recreational (weight) landings and revisit estimation of historic landings
- Quantify and evaluate appropriate weighting procedures of length and age compositions at finer spatial and temporal scales (e.g., quarterly/state/sub-region strata)
- Obtain consistent funding source to ensure continuation of sampling of discard length composition for Scamp and other reef fish
- Characterize imputations in MRIP statistics at finer level (e.g., identify round of imputation)

Recreational CPUE indices

- Additional research is needed to investigate if assumptions are appropriate across full time series (e.g., targeting, trip length, effects of various regulations, Red Snapper)

8. References

- Brooks EN, KW Shertzer, T Gedamke and DS Vaughan. 2008. Stock assessment of protogynous fish: evaluating measures of spawning biomass used to estimate biological reference points. *Fishery Bulletin* 106:12-28.
- Diaz GA, CE Porch, and M Ortiz. 2004. Growth models for red snapper in U.S. Gulf of Mexico waters estimated from landings with minimum size limit restrictions. NMFS/SEFSC/SFD 2004-038, 13 p.
- Dichmont, CM, RA Deng, AE Punt, J Brodziak, YJ Chang, JM Cope, JN Ianelli, CM Legault, RD Methot, CE Porch and MH Prager. 2016. A review of stock assessment packages in the United States. *Fisheries Research* 183:447-460.
- Francis RICC. 2011. Data weighting in statistical fisheries stock assessment models. *Canadian Journal of Fisheries and Aquatic Sciences*. 68:1124-1138.
- Francis RICC, RJ Hurst and JA Renwick. 2003 Quantifying annual variation in catchability for commercial and research fishing. *Fishery Bulletin* 101(2):293-304.
- Harford WJ, SR Sagarese and M Karnauskas. 2019. Coping with information gaps in stock productivity for rebuilding and achieving maximum sustainable yield for grouper–snapper fisheries. *Fish and Fisheries* 20(2):303-321.
- Hulson P-J, D Hanselman, and T Quinn. 2012. Determining effective sample size in integrated age-structured assessment models. *ICES Journal of Marine Science*, 69:281-292.
- Lorenzen K. 1996. The relationship between body weight and natural mortality in juvenile and adult fish: a comparison of natural ecosystems and aquaculture. *Journal of Fish Biology* 49:627–647.
- Lorenzen K. 2000. Allometry of natural mortality as a basis for assessing optimal release size in fish-stocking programmes. *Canadian Journal of Fisheries and Aquatic Sciences* 57(12):2374-2381.
- Matter VM and A Rios. 2013. MRFSS to MRIP Adjustment Ratios and Weight Estimation Procedures for South Atlantic and Gulf of Mexico Managed Species. SEDAR32-DW-02. SEDAR, North Charleston, SC. 6 pp.
- Methot RD and IG Taylor. 2011. Adjusting for bias due to variability of estimated recruitments in fishery assessment models. *Canadian Journal of Fisheries and Aquatic Sciences*, 68(10):1744-1760.
- Methot RD and CR Wetzel. 2013. Stock Synthesis: a biological and statistical framework for fish stock assessment and fishery management. *Fisheries Research* 142:86–99.
- Methot RD, CR Wetzel, IG Taylor and K Doering. 2020. Stock Synthesis User Manual Version 3.30.16. NOAA Fisheries, Seattle Washington. 225 pp.
- Pulver JR. 2017. Sink or swim? Factors affecting immediate discard mortality for the Gulf of Mexico commercial reef fish fishery. *Fisheries Research* 188:166-172.

- Quinn T and R Deriso. 1999. Quantitative fish dynamics. Oxford University Press, New York.
- Saari C and L Beerkircher. 2014. User's Guide for the TIP Trip Interview Program Version 6.0. United States Department of Commerce, NOAA NMFS Southeast Fisheries Science Center. 199 pp.
- SEDAR (Southeast Data Assessment and Review). 2014. SEDAR33: Gulf of Mexico Gag Grouper Stock Assessment Report. SEDAR, North Charleston, SC. 609 p. Available at: <http://sedarweb.org/sedar-33>.
- SEDAR (Southeast Data Assessment and Review). 2015. SEDAR42: Gulf of Mexico Red Grouper Stock Assessment Report. SEDAR, North Charleston, SC. 612 p. Available at: <http://sedarweb.org/sedar-42>.
- SEDAR (Southeast Data Assessment and Review). 2016. SEDAR 49 Gulf of Mexico Data-Limited Species Stock Assessment Report. SEDAR, North Charleston, SC. 618 pp. Available at: <http://sedarweb.org/sedar-49>.
- Shepherd G, K Shertzer, J Coakley and M Caldwell (Eds.). 2013. Modeling protogynous hermaphrodite fishes workshop. SEDAR33-RD-19. SEDAR, North Charleston, SC. 35 pp.
- Shertzer KW and PB Conn. 2012. Spawner-recruit relationships of demersal marine fishes: prior distribution of steepness. *Bulletin of Marine Science*, 88(1):39-50.
- Then AY, JM Hoenig, NG Hall, and DA Hewitt. 2015. Evaluating the predictive performance of empirical estimators of natural mortality rate using information on over 200 fish species. *ICES Journal of Marine Science* 72(1):82-92.
- Thorson JT, KF Johnson, RD Methot and IG Taylor. 2017. Model-based estimates of effective sample size in stock assessment models using the Dirichlet-multinomial distribution. *Fisheries Research* 192: 84–93. [doi:10.1016/j.fishres.2016.06.005](https://doi.org/10.1016/j.fishres.2016.06.005).
- Taylor IG, KL Doering, KF Johnson, CR Wetzel and IJ Stewart, 2021. Beyond visualizing catch-at-age models: Lessons learned from the r4ss package about software to support stock assessments, *Fisheries Research* 239:105924. <https://doi.org/10.1016/j.fishres.2021.105924>.
- Walter J, M Drymon, C Gardner, C Hightower, W Patterson, S Powers, K Thompson and T Switzer. 2017. A multinomial predictive model to incorporate visual surveys of red snapper lengths. SEDAR52-WP-22. SEDAR, North Charleston, SC. 21 pp.
- Walter J, K Thompson and T Switzer. 2020. Model-based size composition of vermilion snapper obtained from three visual surveys. SEDAR67-WP-16. SEDAR, North Charleston, SC. 15 pp.

9. Tables

Table 1. Conversion factors used to convert fork length in centimeters (cm FL) to gutted weight (gw) in kilograms and whole weight (ww) in kilograms to gw in kilograms for Gulf of Mexico Scamp. Units are gw (kg) or ww (kg) and FL (cm). MSE = mean squared error.

| Sex | Model | N | R2 | Range | MSE |
|-------------------|--|--------|--------|-------------------|-------|
| Combined | | | | | |
| Males and Females | $gw = 1.186 \text{ E-}05 \times (FL)^{3.04}$ | 30,798 | 0.9400 | 22.0 – 117.0 (FL) | 0.016 |
| | $gw = 0.95 \times ww$ | 396 | 0.9987 | 0.136 – 7.8 (ww) | - |

Table 2. Von Bertalanffy growth parameters recommended for Gulf of Mexico Scamp.

| Parameter | Value |
|----------------------|--------|
| L_{∞} (cm FL) | 70.222 |
| K (per year) | 0.134 |
| t_0 (year) | -1.762 |
| CV at age (constant) | 0.130 |

Table 3. Age-specific natural mortality (per year) for Gulf of Mexico Scamp. Female and male natural mortality were assumed equivalent.

| Age | Base M | Low M Sensitivity | High M Sensitivity |
|-----|----------|---------------------|----------------------|
| 0 | 0.4989 | 0.4762 | 0.5241 |
| 1 | 0.3759 | 0.3588 | 0.3949 |
| 2 | 0.3095 | 0.2954 | 0.3251 |
| 3 | 0.2682 | 0.2560 | 0.2817 |
| 4 | 0.2402 | 0.2293 | 0.2523 |
| 5 | 0.2201 | 0.2101 | 0.2312 |
| 6 | 0.2051 | 0.1958 | 0.2155 |
| 7 | 0.1936 | 0.1848 | 0.2034 |
| 8 | 0.1845 | 0.1761 | 0.1939 |
| 9 | 0.1773 | 0.1692 | 0.1862 |

Table 3 Continued. Age-specific natural mortality (per year) for Gulf of Mexico Scamp. Female and male natural mortality were assumed equivalent.

| Age | Base M | Low M Sensitivity | High M Sensitivity |
|-----|----------|---------------------|----------------------|
| 10 | 0.1714 | 0.1636 | 0.1800 |
| 11 | 0.1665 | 0.1590 | 0.1750 |
| 12 | 0.1625 | 0.1551 | 0.1707 |
| 13 | 0.1592 | 0.1519 | 0.1672 |
| 14 | 0.1563 | 0.1492 | 0.1642 |
| 15 | 0.1540 | 0.1470 | 0.1617 |
| 16 | 0.1519 | 0.1450 | 0.1596 |
| 17 | 0.1502 | 0.1434 | 0.1578 |
| 18 | 0.1487 | 0.1419 | 0.1562 |
| 19 | 0.1474 | 0.1407 | 0.1549 |
| 20 | 0.1463 | 0.1397 | 0.1537 |
| 21 | 0.1454 | 0.1388 | 0.1527 |
| 22 | 0.1446 | 0.1380 | 0.1519 |
| 23 | 0.1439 | 0.1373 | 0.1511 |
| 24 | 0.1433 | 0.1367 | 0.1505 |
| 25 | 0.1427 | 0.1362 | 0.1499 |
| 26 | 0.1423 | 0.1358 | 0.1495 |
| 27 | 0.1419 | 0.1354 | 0.1490 |
| 28 | 0.1415 | 0.1351 | 0.1487 |
| 29 | 0.1412 | 0.1348 | 0.1484 |
| 30 | 0.1410 | 0.1345 | 0.1481 |
| 31 | 0.1407 | 0.1343 | 0.1478 |
| 32 | 0.1405 | 0.1341 | 0.1476 |
| 33 | 0.1403 | 0.1340 | 0.1474 |
| 34 | 0.1403 | 0.1340 | 0.1474 |

Table 4. Discard mortality rates for Scamp recommended by the SEDAR 68 DMWG for the commercial fleets in the Gulf of Mexico. The point estimate for total mortality combines the immediate unvented point estimate and delayed mortality estimate. The upper bound combines the immediate unvented point estimate and upper delayed mortality estimate. The lower bound combines the immediate vented point estimate and lower delayed mortality estimate. Confidence intervals were determined based on a bootstrap approach.

| Gear | Mean Depth (m) | Immediate Not Vented | Immediate Vented | Delayed Mortality | Total Discard Mortality |
|-----------------|----------------|----------------------|------------------|-------------------|-------------------------|
| Bottom longline | 72.1 | 53% (48-59%) | 47% (42-53%) | 32% (19-47%) | 68% (57-75%) |
| Vertical line | 54.1 | 29% (24-34%) | 23% (18-27%) | 26% (16-37%) | 47% (40-51%) |

Table 5. Gulf of Mexico Scamp commercial landings in pounds gutted weight. Landings by “Other” gears were lumped into the Commercial Vertical Line fleet for input into the stock assessment. In the absence of uncertainty estimates provided by the SEDAR 68 ComWG for the Gulf of Mexico, commercial landings were assigned a log-scale SE of 0.05 for 1986-2009 (borrowed from the South Atlantic) and 0.01 for 2010-2017 (after implementation of the IFQ program).

| Year | Vertical line | Longline | Other |
|------|---------------|----------|--------|
| 1986 | 178,418 | 174,428 | 5,426 |
| 1987 | 180,054 | 154,070 | 5,340 |
| 1988 | 155,528 | 110,413 | 3,918 |
| 1989 | 160,143 | 127,058 | 4,219 |
| 1990 | 98,192 | 109,170 | 57,821 |
| 1991 | 126,138 | 129,427 | 59,508 |
| 1992 | 166,388 | 76,226 | 59,244 |
| 1993 | 157,538 | 102,138 | 60,857 |
| 1994 | 107,612 | 57,453 | 50,830 |
| 1995 | 130,756 | 60,779 | 44,331 |
| 1996 | 127,483 | 66,710 | 38,874 |
| 1997 | 136,523 | 79,513 | 76,299 |
| 1998 | 98,858 | 85,242 | 36,720 |
| 1999 | 103,402 | 85,405 | 71,820 |
| 2000 | 114,610 | 73,528 | 11,720 |
| 2001 | 133,561 | 112,002 | 22,234 |
| 2002 | 149,582 | 118,036 | 37,010 |

Table 5 Continued. Gulf of Mexico Scamp commercial landings in pounds gutted weight. Landings by “Other” gears were lumped into the Commercial Vertical Line fleet for input into the stock assessment. In the absence of uncertainty estimates provided by the SEDAR 68 ComWG for the Gulf of Mexico, commercial landings were assigned a log-scale SE of 0.05 for 1986-2009 (borrowed from the South Atlantic) and 0.01 for 2010-2017 (after implementation of the IFQ program).

| Year | Vertical line | Longline | Other |
|------|---------------|----------|--------|
| 2003 | 164,033 | 136,708 | 11,873 |
| 2004 | 151,844 | 151,716 | 15,581 |
| 2005 | 154,665 | 141,963 | 12,184 |
| 2006 | 115,795 | 86,282 | 16,039 |
| 2007 | 134,089 | 120,264 | 20,565 |
| 2008 | 122,179 | 138,725 | 17,137 |
| 2009 | 141,610 | 89,656 | 19,705 |
| 2010 | 75,920 | 64,936 | 15,196 |
| 2011 | 75,374 | 60,415 | 10,094 |
| 2012 | 141,092 | 93,246 | 16,090 |
| 2013 | 125,540 | 103,610 | 16,076 |
| 2014 | 96,972 | 62,095 | 9,393 |
| 2015 | 91,383 | 80,820 | 6,309 |
| 2016 | 141,099 | 143,307 | 1,628 |
| 2017 | 84,705 | 77,086 | 1,185 |

Table 6A. Gulf of Mexico Scamp recreational landings in pounds gutted weight, which were converted from pounds whole weight (**Table 1**). Recreational landings in weights were input into the base stock assessment model. Since no estimates of uncertainty were provided by the SEDAR 68 RecWG for weight estimates, uncertainty was borrowed for recreational landings in numbers (**Table 6B**). Landings input into the assessment include Headboat and Charter Private.

| Year | Headboat | Charter | Private | Charter Private |
|------|----------|---------|---------|-----------------|
| 1986 | 17,095 | 100,057 | 93,627 | 193,684 |
| 1987 | 11,112 | 43,340 | 221,965 | 265,306 |
| 1988 | 8,117 | 40,196 | 97,570 | 137,767 |
| 1989 | 22,966 | 56,785 | 24,854 | 81,639 |
| 1990 | 6,586 | 22,195 | 254 | 22,450 |

Table 6A Continued. Gulf of Mexico Scamp recreational landings in pounds gutted weight, which were converted from pounds whole weight (**Table 1**). Recreational landings in weights were input into the base stock assessment model. Since no estimates of uncertainty were provided by the SEDAR 68 RecWG for weight estimates, uncertainty was borrowed for recreational landings in numbers (**Table 6B**). Landings input into the assessment include Headboat and Charter Private.

| Year | Headboat | Charter | Private | Charter Private |
|------|----------|---------|---------|-----------------|
| 1991 | 7,136 | 16,030 | 29,751 | 45,782 |
| 1992 | 3,997 | 42,131 | 15,554 | 57,686 |
| 1993 | 3,916 | 75,137 | 46,999 | 122,137 |
| 1994 | 2,790 | 50,061 | 355 | 50,417 |
| 1995 | 3,529 | 14,783 | 148 | 14,931 |
| 1996 | 2,360 | 42,263 | 110 | 42,373 |
| 1997 | 2,707 | 69,546 | 29,685 | 99,232 |
| 1998 | 4,809 | 124,586 | 3,680 | 128,266 |
| 1999 | 2,596 | 103,490 | 47,306 | 150,796 |
| 2000 | 4,185 | 21,121 | 20,588 | 41,710 |
| 2001 | 1,686 | 46,776 | 14,444 | 61,221 |
| 2002 | 1,731 | 40,101 | 48,007 | 88,109 |
| 2003 | 1,773 | 38,773 | 111,275 | 150,048 |
| 2004 | 2,857 | 92,177 | 38,462 | 130,639 |
| 2005 | 2,121 | 49,653 | 112,440 | 162,094 |
| 2006 | 2,447 | 52,879 | 255,236 | 308,116 |
| 2007 | 2,237 | 35,368 | 62,131 | 97,499 |
| 2008 | 1,964 | 33,396 | 202,925 | 236,321 |
| 2009 | 1,349 | 44,685 | 147,412 | 192,097 |
| 2010 | 3,696 | 18,966 | 66,005 | 84,972 |
| 2011 | 4,176 | 34,414 | 70,597 | 105,012 |
| 2012 | 3,454 | 42,051 | 178,615 | 220,667 |
| 2013 | 4,237 | 47,602 | 205,497 | 253,100 |
| 2014 | 6,613 | 68,532 | 185,178 | 253,710 |
| 2015 | 8,780 | 47,592 | 281,404 | 328,997 |
| 2016 | 5,480 | 104,574 | 132,338 | 236,913 |
| 2017 | 4,108 | 69,289 | 115,911 | 185,200 |

Table 6B. Gulf of Mexico Scamp recreational landings in numbers (1,000s of fish) and associated log-scaled standard errors (SE). Log-scale SEs were converted from CVs provided for landings in numbers (**Section 2.3.9**). Any errors below 0.01 were input as 0.01.

| Year | Headboat | Headboat SE | Charter | Private | Charter Private | Charter Private SE |
|------|----------|-------------|---------|---------|-----------------|--------------------|
| 1986 | 7.263 | 0.058 | 22.873 | 24.902 | 47.775 | 0.312 |
| 1987 | 4.577 | 0.046 | 10.150 | 58.366 | 68.516 | 0.586 |
| 1988 | 3.399 | 0.049 | 11.175 | 28.352 | 39.527 | 0.275 |
| 1989 | 9.310 | 0.030 | 12.590 | 6.021 | 18.611 | 0.358 |
| 1990 | 2.388 | 0.033 | 6.450 | 0.074 | 6.524 | 0.764 |
| 1991 | 2.056 | 0.019 | 5.170 | 9.703 | 14.873 | 0.646 |
| 1992 | 1.611 | 0.011 | 10.118 | 3.534 | 13.651 | 0.358 |
| 1993 | 1.685 | 0.006 | 14.397 | 9.036 | 23.434 | 0.412 |
| 1994 | 1.137 | 0.040 | 12.769 | 0.099 | 12.868 | 0.538 |
| 1995 | 1.370 | 0.102 | 4.296 | 0.034 | 4.330 | 0.586 |
| 1996 | 0.813 | 0.069 | 12.281 | 0.032 | 12.313 | 0.547 |
| 1997 | 1.165 | 0.041 | 10.200 | 4.519 | 14.720 | 0.349 |
| 1998 | 1.241 | 0.026 | 20.104 | 0.629 | 20.733 | 0.208 |
| 1999 | 1.064 | 0.021 | 26.794 | 12.935 | 39.730 | 0.275 |
| 2000 | 1.028 | 0.030 | 5.297 | 5.265 | 10.563 | 0.358 |
| 2001 | 0.616 | 0.032 | 10.311 | 3.263 | 13.574 | 0.208 |
| 2002 | 0.705 | 0.046 | 10.832 | 13.631 | 24.463 | 0.275 |
| 2003 | 0.675 | 0.026 | 11.725 | 33.667 | 45.392 | 0.481 |
| 2004 | 1.315 | 0.063 | 31.443 | 20.665 | 52.108 | 0.256 |
| 2005 | 1.075 | 0.018 | 17.904 | 43.379 | 61.283 | 0.455 |
| 2006 | 0.589 | 0.040 | 17.974 | 87.416 | 105.390 | 0.682 |
| 2007 | 0.668 | 0.042 | 11.912 | 28.549 | 40.461 | 0.303 |
| 2008 | 0.608 | 0.016 | 9.168 | 50.681 | 59.849 | 0.438 |
| 2009 | 0.598 | 0.005 | 12.582 | 36.665 | 49.247 | 0.522 |
| 2010 | 0.992 | 0.005 | 6.260 | 21.147 | 27.407 | 0.447 |
| 2011 | 0.815 | 0.000 | 14.872 | 29.077 | 43.949 | 0.256 |
| 2012 | 1.096 | 0.000 | 11.210 | 64.982 | 76.192 | 0.331 |

Table 6B Continued. Gulf of Mexico Scamp recreational landings in numbers (1,000s of fish) and associated log-scaled standard errors (SE). Log-scale SEs were converted from CVs provided for landings in numbers (**Section 2.3.9**). Any errors below 0.01 were input as 0.01.

| Year | Headboat | Headboat SE | Charter | Private | Charter Private | Charter Private SE |
|------|----------|-------------|---------|---------|-----------------|--------------------|
| 2013 | 1.388 | 0.001 | 14.262 | 62.888 | 77.150 | 0.246 |
| 2014 | 2.100 | 0.000 | 18.497 | 57.838 | 76.336 | 0.284 |
| 2015 | 2.613 | 0.000 | 13.668 | 92.326 | 105.994 | 0.498 |
| 2016 | 1.730 | 0.000 | 24.430 | 44.122 | 68.552 | 0.322 |
| 2017 | 1.537 | 0.000 | 14.916 | 31.528 | 46.444 | 0.403 |

Table 7. Gulf of Mexico Scamp commercial discards in numbers (1,000s of fish) with associated log-scale standard errors (SE) input into the assessment model. Discards refer to the total number of fish discarded before applying the discard mortality rate.

| Year | Vertical Line | Vertical Line SE | Longline | Longline SE |
|------|---------------|------------------|----------|-------------|
| 2000 | 2,945 | 0.390 | 461 | 0.497 |
| 2001 | 3,469 | 0.390 | 564 | 0.497 |
| 2002 | 3,842 | 0.390 | 532 | 0.497 |
| 2003 | 4,235 | 0.390 | 643 | 0.497 |
| 2004 | 4,083 | 0.390 | 687 | 0.497 |
| 2005 | 3,611 | 0.390 | 691 | 0.497 |
| 2006 | 3,230 | 0.390 | 509 | 0.497 |
| 2007 | 3,080 | 0.390 | 536 | 0.497 |
| 2008 | 2,747 | 0.405 | 667 | 0.497 |
| 2009 | 3,356 | 0.412 | 429 | 0.497 |
| 2010 | 2,421 | 0.421 | 250 | 0.333 |
| 2011 | 2,735 | 0.421 | 403 | 0.333 |
| 2012 | 3,422 | 0.421 | 379 | 0.333 |
| 2013 | 2,821 | 0.421 | 457 | 0.333 |
| 2014 | 2,657 | 0.421 | 523 | 0.333 |
| 2015 | 2,301 | 0.421 | 618 | 0.333 |
| 2016 | 2,790 | 0.421 | 663 | 0.333 |
| 2017 | 2,112 | 0.421 | 643 | 0.333 |

Table 8. Gulf of Mexico Scamp recreational discards in numbers (1,000s of fish) with associated log-scale standard errors (SE) input into the assessment model. Discards refer to the total number of fish discarded before applying the discard mortality rate. Discards input into the assessment include Headboat and Charter Private and their associated log-scale SEs.

| Year | Headboat | Headboat SE | Charter | Private | Charter Private | Charter Private SE |
|------|----------|-------------|---------|---------|-----------------|--------------------|
| 1986 | 0.000 | 0.000 | 30.041 | 24.077 | 54.118 | 0.609 |
| 1987 | 0.000 | 0.000 | 0.605 | 0.823 | 1.428 | 0.646 |
| 1988 | 0.000 | 0.000 | 0.323 | 3.378 | 3.701 | 0.783 |
| 1989 | 0.000 | 0.000 | 1.858 | 0.000 | 1.858 | 0.617 |
| 1990 | 0.000 | 0.000 | 4.395 | 36.301 | 40.696 | 0.601 |
| 1991 | 0.000 | 0.000 | 0.000 | 3.128 | 3.128 | 0.833 |
| 1992 | 0.000 | 0.000 | 4.443 | 27.406 | 31.849 | 0.506 |
| 1993 | 0.000 | 0.000 | 2.723 | 37.345 | 40.068 | 0.489 |
| 1994 | 0.000 | 0.000 | 2.007 | 10.786 | 12.792 | 0.639 |
| 1995 | 0.000 | 0.000 | 1.922 | 2.859 | 4.780 | 0.578 |
| 1996 | 0.000 | 0.000 | 0.114 | 0.816 | 0.930 | 0.757 |
| 1997 | 0.000 | 0.000 | 3.554 | 3.471 | 7.025 | 0.578 |
| 1998 | 0.000 | 0.000 | 1.661 | 2.884 | 4.545 | 0.481 |
| 1999 | 0.000 | 0.000 | 0.661 | 8.983 | 9.645 | 0.530 |
| 2000 | 1.811 | 0.472 | 2.153 | 61.616 | 63.768 | 0.751 |
| 2001 | 0.676 | 0.472 | 3.792 | 51.082 | 54.874 | 0.661 |
| 2002 | 0.768 | 0.472 | 8.637 | 11.268 | 19.904 | 0.349 |
| 2003 | 1.040 | 0.472 | 5.886 | 164.133 | 170.019 | 0.403 |
| 2004 | 1.610 | 0.472 | 20.433 | 156.051 | 176.484 | 0.322 |
| 2005 | 0.685 | 0.472 | 6.051 | 20.881 | 26.932 | 0.322 |
| 2006 | 0.469 | 0.472 | 1.650 | 17.476 | 19.127 | 0.455 |
| 2007 | 0.671 | 0.472 | 6.408 | 82.688 | 89.096 | 0.322 |
| 2008 | 2.799 | 0.472 | 9.896 | 104.783 | 114.679 | 0.358 |
| 2009 | 2.682 | 0.472 | 5.081 | 138.261 | 143.342 | 0.472 |
| 2010 | 1.760 | 0.472 | 7.153 | 224.917 | 232.070 | 0.385 |
| 2011 | 1.936 | 0.472 | 1.698 | 29.744 | 31.442 | 0.438 |
| 2012 | 1.909 | 0.472 | 1.370 | 183.013 | 184.383 | 0.617 |

Table 8 Continued. Gulf of Mexico Scamp recreational discards in numbers (1,000s of fish) with associated log-scale standard errors (SE) input into the assessment model. Discards refer to the total number of fish discarded before applying the discard mortality rate. Discards input into the assessment include Headboat and Charter Private and their associated log-scale SEs.

| Year | Headboat | Headboat SE | Charter | Private | Charter Private | Charter Private SE |
|------|----------|-------------|---------|---------|-----------------|--------------------|
| 2013 | 1.895 | 0.472 | 3.009 | 25.356 | 28.365 | 0.498 |
| 2014 | 2.970 | 0.472 | 5.941 | 119.954 | 125.895 | 0.312 |
| 2015 | 3.500 | 0.472 | 5.988 | 178.674 | 184.662 | 0.498 |
| 2016 | 1.880 | 0.472 | 17.399 | 41.688 | 59.087 | 0.349 |
| 2017 | 1.689 | 0.472 | 5.222 | 71.870 | 77.091 | 0.609 |

Table 9. Standardized indices of relative abundance and associated log-scale standard errors (SE) for Gulf of Mexico Scamp. The SE were scaled to a common mean of 0.2 for the fishery-dependent Commercial Vertical Line (ComVL) and Headboat indices.

| Year | ComVL CPUE | ComVL SE | Headboat CPUE | Headboat SE | Combined Video | Combined Video SE | RFOP VL CPUE | RFOP VL SE |
|------|------------|----------|---------------|-------------|----------------|-------------------|--------------|------------|
| 1986 | | | 2.015 | 0.188 | | | | |
| 1987 | | | 1.384 | 0.194 | | | | |
| 1988 | | | 1.477 | 0.181 | | | | |
| 1989 | | | 0.817 | 0.186 | | | | |
| 1990 | | | 1.172 | 0.183 | | | | |
| 1991 | | | 0.979 | 0.190 | | | | |
| 1992 | | | 0.708 | 0.183 | | | | |
| 1993 | 0.986 | 0.202 | 0.745 | 0.183 | 0.870 | 0.172 | | |
| 1994 | 0.849 | 0.200 | 0.863 | 0.183 | 0.497 | 0.231 | | |
| 1995 | 1.254 | 0.200 | 1.208 | 0.186 | 0.565 | 0.251 | | |
| 1996 | 1.048 | 0.200 | 0.846 | 0.194 | 0.778 | 0.173 | | |
| 1997 | 1.314 | 0.200 | 0.764 | 0.211 | 0.645 | 0.134 | | |
| 1998 | 0.991 | 0.200 | 0.967 | 0.203 | | | | |
| 1999 | 0.954 | 0.199 | 0.679 | 0.223 | | | | |
| 2000 | 0.634 | 0.200 | 0.806 | 0.204 | | | | |
| 2001 | 1.005 | 0.200 | 0.667 | 0.215 | | | | |

Table 9 Continued. Standardized indices of relative abundance and associated log-scale standard errors (SE) for Gulf of Mexico Scamp. The SE were scaled to a common mean of 0.2 for the fishery-dependent Commercial Vertical Line (ComVL) and Headboat indices.

| Year | ComVL CPUE | ComVL SE | Headboat CPUE | Headboat SE | Combined Video | Combined Video SE | RFOP VL CPUE | RFOP VL SE |
|------|---------------|-------------|------------------|----------------|-------------------|----------------------|-----------------|---------------|
| 2002 | 0.991 | 0.2 | 1.005 | 0.197 | 1.758 | 0.141 | | |
| 2003 | 0.948 | 0.2 | 0.791 | 0.216 | | | | |
| 2004 | 1.081 | 0.2 | 1.329 | 0.193 | 1.990 | 0.174 | | |
| 2005 | 1.302 | 0.2 | 1.287 | 0.194 | 1.499 | 0.133 | | |
| 2006 | 0.847 | 0.2 | 0.943 | 0.218 | 0.941 | 0.167 | | |
| 2007 | 1.001 | 0.2 | 1.546 | 0.219 | 1.532 | 0.120 | 0.923 | 0.103 |
| 2008 | 0.966 | 0.2 | 1.440 | 0.202 | 1.131 | 0.147 | 0.998 | 0.176 |
| 2009 | 0.829 | 0.2 | 0.912 | 0.198 | 1.228 | 0.127 | 0.979 | 0.185 |
| 2010 | | | 0.708 | 0.234 | 1.071 | 0.124 | 0.682 | 0.198 |
| 2011 | | | 1.757 | 0.207 | 1.182 | 0.097 | 0.602 | 0.130 |
| 2012 | | | 1.066 | 0.187 | 0.673 | 0.119 | 1.206 | 0.059 |
| 2013 | | | 0.676 | 0.222 | 0.729 | 0.118 | 1.072 | 0.218 |
| 2014 | | | 0.733 | 0.198 | 0.876 | 0.117 | 0.864 | 0.094 |
| 2015 | | | 0.785 | 0.198 | 0.938 | 0.131 | 1.142 | 0.074 |
| 2016 | | | 0.461 | 0.194 | 0.790 | 0.102 | 1.251 | 0.098 |
| 2017 | | | 0.460 | 0.216 | 0.751 | 0.115 | 1.066 | 0.126 |

Table 10. List of SS parameters for Gulf of Mexico Scamp. The list includes expected parameter values, lower and upper bounds of the parameters, associated standard deviations (SD) and coefficients of variation (CV), the prior type and densities (value, SD) assigned to the parameters as applicable, and phases (negative identifies parameters that were fixed). Parameters designated as fixed were held at their initial values and have no associated range or SD.

| Label | Value | Range | SD | CV | Prior | Phase |
|----------------------|---------|------------|-------|-------|-------|-------|
| L_at_Amin_Fem_GP_1 | 10.1878 | (1,40) | 0.192 | 0.019 | | 2 |
| L_at_Amax_Fem_GP_1 | 70.222 | (60,100) | | | | -4 |
| VonBert_K_Fem_GP_1 | 0.1341 | (0.05,0.3) | | | | -4 |
| CV_young_Fem_GP_1 | 0.1298 | (0.01,0.5) | | | | -3 |
| CV_old_Fem_GP_1 | 0.1298 | (0.01,0.5) | | | | -3 |
| Wtlen_1_Fem_GP_1 | 0 | (0,1) | | | | -2 |
| Wtlen_2_Fem_GP_1 | 3.04 | (0,4) | | | | -3 |
| Mat50%_Fem_GP_1 | 3.4068 | (1,10) | | | | -3 |
| Mat_slope_Fem_GP_1 | -1.3346 | (-10,0) | | | | -3 |
| Eggs_scalar_Fem_GP_1 | 1 | (-1,1) | | | | -3 |
| Eggs_exp_wt_Fem_GP_1 | 1 | (0,4) | | | | -3 |
| L_at_Amin_Mal_GP_1 | 0 | (-1,1) | | | | -3 |
| L_at_Amax_Mal_GP_1 | 0 | (-1,1) | | | | -4 |
| VonBert_K_Mal_GP_1 | 0 | (-1,1) | | | | -4 |
| CV_young_Mal_GP_1 | 0 | (-1,1) | | | | -3 |
| CV_old_Mal_GP_1 | 0 | (-1,1) | | | | -3 |
| Wtlen_1_Mal_GP_1 | 0 | (0,1) | | | | -2 |
| Wtlen_2_Mal_GP_1 | 3.04 | (0,4) | | | | -3 |
| Herm_Infl_age | 21.5253 | (10,34) | | | | -4 |
| Herm_stdev | 10.1407 | (1,20) | | | | -4 |
| Herm_asymptote | 0.8907 | (0,1) | | | | -4 |
| CohortGrowDev | 1 | (0.1,10) | | | | -1 |
| FracFemale_GP_1 | 1 | (1e-06,1) | | | | -99 |
| SR_LN(R0) | 7.4331 | (1,40) | 0.021 | 0.003 | | 1 |
| SR_BH_steep | 0.9487 | (0.2,0.99) | 0.039 | 0.041 | | 3 |
| SR_sigmaR | 0.3559 | (0,2) | 0.045 | 0.126 | | 4 |
| SR_regime | 0 | (-5,5) | | | | -4 |
| SR_autocorr | 0 | (0,0.5) | | | | -99 |

Table 10 Continued. List of SS parameters for Gulf of Mexico Scamp.

| Label | Value | Range | SD | CV | Prior | Phase |
|-------------------------|---------|--------|-------|--------|-------|-------|
| Main_RecrDev_1986 | -0.6129 | (-5,5) | 0.183 | -0.299 | | 2 |
| Main_RecrDev_1987 | -0.3132 | (-5,5) | 0.161 | -0.514 | | 2 |
| Main_RecrDev_1988 | -0.2549 | (-5,5) | 0.16 | -0.628 | | 2 |
| Main_RecrDev_1989 | 0.3306 | (-5,5) | 0.124 | 0.375 | | 2 |
| Main_RecrDev_1990 | 0.4634 | (-5,5) | 0.134 | 0.289 | | 2 |
| Main_RecrDev_1991 | 0.1583 | (-5,5) | 0.188 | 1.187 | | 2 |
| Main_RecrDev_1992 | 0.3881 | (-5,5) | 0.152 | 0.392 | | 2 |
| Main_RecrDev_1993 | 0.0741 | (-5,5) | 0.175 | 2.362 | | 2 |
| Main_RecrDev_1994 | 0.0424 | (-5,5) | 0.154 | 3.636 | | 2 |
| Main_RecrDev_1995 | 0.1842 | (-5,5) | 0.124 | 0.673 | | 2 |
| Main_RecrDev_1996 | 0.227 | (-5,5) | 0.121 | 0.533 | | 2 |
| Main_RecrDev_1997 | 0.123 | (-5,5) | 0.142 | 1.155 | | 2 |
| Main_RecrDev_1998 | 0.5718 | (-5,5) | 0.126 | 0.22 | | 2 |
| Main_RecrDev_1999 | 0.2655 | (-5,5) | 0.214 | 0.806 | | 2 |
| Main_RecrDev_2000 | 0.7004 | (-5,5) | 0.173 | 0.247 | | 2 |
| Main_RecrDev_2001 | 0.2562 | (-5,5) | 0.245 | 0.956 | | 2 |
| Main_RecrDev_2002 | 0.5591 | (-5,5) | 0.158 | 0.283 | | 2 |
| Main_RecrDev_2003 | 0.0103 | (-5,5) | 0.19 | 18.379 | | 2 |
| Main_RecrDev_2004 | -0.2073 | (-5,5) | 0.18 | -0.868 | | 2 |
| Main_RecrDev_2005 | -0.252 | (-5,5) | 0.158 | -0.627 | | 2 |
| Main_RecrDev_2006 | -0.1687 | (-5,5) | 0.127 | -0.753 | | 2 |
| Main_RecrDev_2007 | -0.1073 | (-5,5) | 0.108 | -1.007 | | 2 |
| Main_RecrDev_2008 | -0.3335 | (-5,5) | 0.113 | -0.339 | | 2 |
| Main_RecrDev_2009 | -0.3886 | (-5,5) | 0.104 | -0.268 | | 2 |
| Main_RecrDev_2010 | -0.558 | (-5,5) | 0.111 | -0.199 | | 2 |
| Main_RecrDev_2011 | -0.5921 | (-5,5) | 0.12 | -0.203 | | 2 |
| Main_RecrDev_2012 | -0.6525 | (-5,5) | 0.146 | -0.224 | | 2 |
| Main_RecrDev_2013 | 0.0162 | (-5,5) | 0.142 | 8.766 | | 2 |
| Main_RecrDev_2014 | 0.0704 | (-5,5) | 0.214 | 3.04 | | 2 |
| Late_RecrDev_2015 | 0 | | | | | |
| Late_RecrDev_2016 | 0 | | | | | |
| Late_RecrDev_2017 | 0 | | | | | |
| InitF_seas_1_flt_1ComVL | 0.056 | (0,1) | 0.004 | 0.071 | | 1 |

Table 10 Continued. List of SS parameters for Gulf of Mexico Scamp.

| Label | Value | Range | SD | CV | Prior | Phase |
|-----------------------------------|--------|-------|-------|-------|-------|-------|
| InitF_seas_1_flt_2ComLL | 0.0623 | (0,1) | 0.005 | 0.08 | | 1 |
| InitF_seas_1_flt_3Charter_Private | 0.0507 | (0,1) | 0.003 | 0.059 | | 1 |
| F_fleet_1_YR_1986_s_1 | 0.0633 | (0,4) | 0.004 | 0.063 | | 1 |
| F_fleet_1_YR_1987_s_1 | 0.0662 | (0,4) | 0.005 | 0.076 | | 1 |
| F_fleet_1_YR_1988_s_1 | 0.0578 | (0,4) | 0.004 | 0.069 | | 1 |
| F_fleet_1_YR_1989_s_1 | 0.0594 | (0,4) | 0.004 | 0.067 | | 1 |
| F_fleet_1_YR_1990_s_1 | 0.0871 | (0,4) | 0.006 | 0.069 | | 1 |
| F_fleet_1_YR_1991_s_1 | 0.1059 | (0,4) | 0.007 | 0.066 | | 1 |
| F_fleet_1_YR_1992_s_1 | 0.1341 | (0,4) | 0.009 | 0.067 | | 1 |
| F_fleet_1_YR_1993_s_1 | 0.1368 | (0,4) | 0.009 | 0.066 | | 1 |
| F_fleet_1_YR_1994_s_1 | 0.1001 | (0,4) | 0.007 | 0.07 | | 1 |
| F_fleet_1_YR_1995_s_1 | 0.1048 | (0,4) | 0.007 | 0.067 | | 1 |
| F_fleet_1_YR_1996_s_1 | 0.0922 | (0,4) | 0.006 | 0.065 | | 1 |
| F_fleet_1_YR_1997_s_1 | 0.1103 | (0,4) | 0.008 | 0.073 | | 1 |
| F_fleet_1_YR_1998_s_1 | 0.066 | (0,4) | 0.005 | 0.076 | | 1 |
| F_fleet_1_YR_1999_s_1 | 0.0524 | (0,4) | 0.004 | 0.076 | | 1 |
| F_fleet_1_YR_2000_s_1 | 0.036 | (0,4) | 0.002 | 0.056 | | 1 |
| F_fleet_1_YR_2001_s_1 | 0.0423 | (0,4) | 0.003 | 0.071 | | 1 |
| F_fleet_1_YR_2002_s_1 | 0.0486 | (0,4) | 0.003 | 0.062 | | 1 |
| F_fleet_1_YR_2003_s_1 | 0.0449 | (0,4) | 0.003 | 0.067 | | 1 |
| F_fleet_1_YR_2004_s_1 | 0.042 | (0,4) | 0.003 | 0.071 | | 1 |
| F_fleet_1_YR_2005_s_1 | 0.0404 | (0,4) | 0.003 | 0.074 | | 1 |
| F_fleet_1_YR_2006_s_1 | 0.0303 | (0,4) | 0.002 | 0.066 | | 1 |
| F_fleet_1_YR_2007_s_1 | 0.0339 | (0,4) | 0.002 | 0.059 | | 1 |
| F_fleet_1_YR_2008_s_1 | 0.0304 | (0,4) | 0.002 | 0.066 | | 1 |
| F_fleet_1_YR_2009_s_1 | 0.0361 | (0,4) | 0.002 | 0.055 | | 1 |
| F_fleet_1_YR_2010_s_1 | 0.0214 | (0,4) | 0.001 | 0.047 | | 1 |
| F_fleet_1_YR_2011_s_1 | 0.0204 | (0,4) | 0.001 | 0.049 | | 1 |
| F_fleet_1_YR_2012_s_1 | 0.0393 | (0,4) | 0.002 | 0.051 | | 1 |
| F_fleet_1_YR_2013_s_1 | 0.0383 | (0,4) | 0.002 | 0.052 | | 1 |
| F_fleet_1_YR_2014_s_1 | 0.0313 | (0,4) | 0.002 | 0.064 | | 1 |
| F_fleet_1_YR_2015_s_1 | 0.032 | (0,4) | 0.002 | 0.062 | | 1 |
| F_fleet_1_YR_2016_s_1 | 0.0532 | (0,4) | 0.004 | 0.075 | | 1 |

Table 10 Continued. List of SS parameters for Gulf of Mexico Scamp.

| Label | Value | Range | SD | CV | Prior | Phase |
|-----------------------|--------|-------|-------|-------|-------|-------|
| F_fleet_1_YR_2017_s_1 | 0.0357 | (0,4) | 0.003 | 0.084 | | 1 |
| F_fleet_2_YR_1986_s_1 | 0.084 | (0,4) | 0.006 | 0.071 | | 1 |
| F_fleet_2_YR_1987_s_1 | 0.0771 | (0,4) | 0.006 | 0.078 | | 1 |
| F_fleet_2_YR_1988_s_1 | 0.0561 | (0,4) | 0.004 | 0.071 | | 1 |
| F_fleet_2_YR_1989_s_1 | 0.0645 | (0,4) | 0.005 | 0.078 | | 1 |
| F_fleet_2_YR_1990_s_1 | 0.0774 | (0,4) | 0.006 | 0.078 | | 1 |
| F_fleet_2_YR_1991_s_1 | 0.0931 | (0,4) | 0.008 | 0.086 | | 1 |
| F_fleet_2_YR_1992_s_1 | 0.0564 | (0,4) | 0.005 | 0.089 | | 1 |
| F_fleet_2_YR_1993_s_1 | 0.0803 | (0,4) | 0.007 | 0.087 | | 1 |
| F_fleet_2_YR_1994_s_1 | 0.0465 | (0,4) | 0.004 | 0.086 | | 1 |
| F_fleet_2_YR_1995_s_1 | 0.0478 | (0,4) | 0.004 | 0.084 | | 1 |
| F_fleet_2_YR_1996_s_1 | 0.0493 | (0,4) | 0.004 | 0.081 | | 1 |
| F_fleet_2_YR_1997_s_1 | 0.055 | (0,4) | 0.005 | 0.091 | | 1 |
| F_fleet_2_YR_1998_s_1 | 0.0549 | (0,4) | 0.005 | 0.091 | | 1 |
| F_fleet_2_YR_1999_s_1 | 0.0356 | (0,4) | 0.003 | 0.084 | | 1 |
| F_fleet_2_YR_2000_s_1 | 0.0288 | (0,4) | 0.002 | 0.07 | | 1 |
| F_fleet_2_YR_2001_s_1 | 0.0413 | (0,4) | 0.003 | 0.073 | | 1 |
| F_fleet_2_YR_2002_s_1 | 0.0417 | (0,4) | 0.003 | 0.072 | | 1 |
| F_fleet_2_YR_2003_s_1 | 0.0471 | (0,4) | 0.003 | 0.064 | | 1 |
| F_fleet_2_YR_2004_s_1 | 0.0517 | (0,4) | 0.004 | 0.077 | | 1 |
| F_fleet_2_YR_2005_s_1 | 0.0471 | (0,4) | 0.003 | 0.064 | | 1 |
| F_fleet_2_YR_2006_s_1 | 0.0272 | (0,4) | 0.002 | 0.074 | | 1 |
| F_fleet_2_YR_2007_s_1 | 0.0358 | (0,4) | 0.002 | 0.056 | | 1 |
| F_fleet_2_YR_2008_s_1 | 0.0403 | (0,4) | 0.003 | 0.074 | | 1 |
| F_fleet_2_YR_2009_s_1 | 0.0261 | (0,4) | 0.002 | 0.077 | | 1 |
| F_fleet_2_YR_2010_s_1 | 0.0191 | (0,4) | 0.001 | 0.052 | | 1 |
| F_fleet_2_YR_2011_s_1 | 0.0178 | (0,4) | 0.001 | 0.056 | | 1 |
| F_fleet_2_YR_2012_s_1 | 0.0285 | (0,4) | 0.001 | 0.035 | | 1 |
| F_fleet_2_YR_2013_s_1 | 0.0341 | (0,4) | 0.002 | 0.059 | | 1 |
| F_fleet_2_YR_2014_s_1 | 0.0221 | (0,4) | 0.001 | 0.045 | | 1 |
| F_fleet_2_YR_2015_s_1 | 0.0319 | (0,4) | 0.002 | 0.063 | | 1 |
| F_fleet_2_YR_2016_s_1 | 0.0642 | (0,4) | 0.005 | 0.078 | | 1 |
| F_fleet_2_YR_2017_s_1 | 0.0389 | (0,4) | 0.003 | 0.077 | | 1 |

Table 10 Continued. List of SS parameters for Gulf of Mexico Scamp.

| Label | Value | Range | SD | CV | Prior | Phase |
|-----------------------|--------|-------|-------|-------|-------|-------|
| F_fleet_3_YR_1986_s_1 | 0.0742 | (0,4) | 0.005 | 0.067 | | 1 |
| F_fleet_3_YR_1987_s_1 | 0.0693 | (0,4) | 0.023 | 0.332 | | 1 |
| F_fleet_3_YR_1988_s_1 | 0.0565 | (0,4) | 0.019 | 0.336 | | 1 |
| F_fleet_3_YR_1989_s_1 | 0.0288 | (0,4) | 0.009 | 0.312 | | 1 |
| F_fleet_3_YR_1990_s_1 | 0.0239 | (0,4) | 0.007 | 0.292 | | 1 |
| F_fleet_3_YR_1991_s_1 | 0.0295 | (0,4) | 0.01 | 0.338 | | 1 |
| F_fleet_3_YR_1992_s_1 | 0.0494 | (0,4) | 0.014 | 0.284 | | 1 |
| F_fleet_3_YR_1993_s_1 | 0.0891 | (0,4) | 0.026 | 0.292 | | 1 |
| F_fleet_3_YR_1994_s_1 | 0.0348 | (0,4) | 0.011 | 0.316 | | 1 |
| F_fleet_3_YR_1995_s_1 | 0.0093 | (0,4) | 0.003 | 0.321 | | 1 |
| F_fleet_3_YR_1996_s_1 | 0.017 | (0,4) | 0.006 | 0.354 | | 1 |
| F_fleet_3_YR_1997_s_1 | 0.0374 | (0,4) | 0.012 | 0.321 | | 1 |
| F_fleet_3_YR_1998_s_1 | 0.0276 | (0,4) | 0.009 | 0.326 | | 1 |
| F_fleet_3_YR_1999_s_1 | 0.0403 | (0,4) | 0.012 | 0.298 | | 1 |
| F_fleet_3_YR_2000_s_1 | 0.0236 | (0,4) | 0.007 | 0.297 | | 1 |
| F_fleet_3_YR_2001_s_1 | 0.0307 | (0,4) | 0.009 | 0.293 | | 1 |
| F_fleet_3_YR_2002_s_1 | 0.0255 | (0,4) | 0.006 | 0.235 | | 1 |
| F_fleet_3_YR_2003_s_1 | 0.0768 | (0,4) | 0.018 | 0.234 | | 1 |
| F_fleet_3_YR_2004_s_1 | 0.0796 | (0,4) | 0.017 | 0.213 | | 1 |
| F_fleet_3_YR_2005_s_1 | 0.0344 | (0,4) | 0.008 | 0.232 | | 1 |
| F_fleet_3_YR_2006_s_1 | 0.0474 | (0,4) | 0.013 | 0.274 | | 1 |
| F_fleet_3_YR_2007_s_1 | 0.0514 | (0,4) | 0.011 | 0.214 | | 1 |
| F_fleet_3_YR_2008_s_1 | 0.0883 | (0,4) | 0.019 | 0.215 | | 1 |
| F_fleet_3_YR_2009_s_1 | 0.077 | (0,4) | 0.019 | 0.247 | | 1 |
| F_fleet_3_YR_2010_s_1 | 0.0709 | (0,4) | 0.016 | 0.226 | | 1 |
| F_fleet_3_YR_2011_s_1 | 0.0412 | (0,4) | 0.011 | 0.267 | | 1 |
| F_fleet_3_YR_2012_s_1 | 0.1201 | (0,4) | 0.034 | 0.283 | | 1 |
| F_fleet_3_YR_2013_s_1 | 0.0861 | (0,4) | 0.024 | 0.279 | | 1 |
| F_fleet_3_YR_2014_s_1 | 0.1507 | (0,4) | 0.031 | 0.206 | | 1 |
| F_fleet_3_YR_2015_s_1 | 0.1712 | (0,4) | 0.042 | 0.245 | | 1 |
| F_fleet_3_YR_2016_s_1 | 0.1243 | (0,4) | 0.031 | 0.249 | | 1 |
| F_fleet_3_YR_2017_s_1 | 0.1255 | (0,4) | 0.039 | 0.311 | | 1 |
| F_fleet_4_YR_1986_s_1 | 0.0079 | (0,4) | 0 | 0 | | 1 |

Table 10 Continued. List of SS parameters for Gulf of Mexico Scamp.

| Label | Value | Range | SD | CV | Prior | Phase |
|-----------------------|---------|----------|-------|-------|-------|-------|
| F_fleet_4_YR_1987_s_1 | 0.0053 | (0,4) | 0.002 | 0.375 | | 1 |
| F_fleet_4_YR_1988_s_1 | 0.0039 | (0,4) | 0.001 | 0.254 | | 1 |
| F_fleet_4_YR_1989_s_1 | 0.0115 | (0,4) | 0.004 | 0.347 | | 1 |
| F_fleet_4_YR_1990_s_1 | 0.0065 | (0,4) | 0.002 | 0.308 | | 1 |
| F_fleet_4_YR_1991_s_1 | 0.0073 | (0,4) | 0.002 | 0.273 | | 1 |
| F_fleet_4_YR_1992_s_1 | 0.0042 | (0,4) | 0.001 | 0.237 | | 1 |
| F_fleet_4_YR_1993_s_1 | 0.0041 | (0,4) | 0.001 | 0.242 | | 1 |
| F_fleet_4_YR_1994_s_1 | 0.0028 | (0,4) | 0.001 | 0.363 | | 1 |
| F_fleet_4_YR_1995_s_1 | 0.0032 | (0,4) | 0.001 | 0.313 | | 1 |
| F_fleet_4_YR_1996_s_1 | 0.002 | (0,4) | 0.001 | 0.503 | | 1 |
| F_fleet_4_YR_1997_s_1 | 0.0022 | (0,4) | 0.001 | 0.455 | | 1 |
| F_fleet_4_YR_1998_s_1 | 0.0038 | (0,4) | 0.001 | 0.261 | | 1 |
| F_fleet_4_YR_1999_s_1 | 0.002 | (0,4) | 0.001 | 0.503 | | 1 |
| F_fleet_4_YR_2000_s_1 | 0.0029 | (0,4) | 0.001 | 0.339 | | 1 |
| F_fleet_4_YR_2001_s_1 | 0.0011 | (0,4) | 0 | 0 | | 1 |
| F_fleet_4_YR_2002_s_1 | 0.0011 | (0,4) | 0 | 0 | | 1 |
| F_fleet_4_YR_2003_s_1 | 0.001 | (0,4) | 0 | 0 | | 1 |
| F_fleet_4_YR_2004_s_1 | 0.0015 | (0,4) | 0 | 0 | | 1 |
| F_fleet_4_YR_2005_s_1 | 9e-04 | (0,4) | 0 | 0 | | 1 |
| F_fleet_4_YR_2006_s_1 | 9e-04 | (0,4) | 0 | 0 | | 1 |
| F_fleet_4_YR_2007_s_1 | 0.001 | (0,4) | 0 | 0 | | 1 |
| F_fleet_4_YR_2008_s_1 | 0.0015 | (0,4) | 0 | 0 | | 1 |
| F_fleet_4_YR_2009_s_1 | 0.0012 | (0,4) | 0 | 0 | | 1 |
| F_fleet_4_YR_2010_s_1 | 0.0023 | (0,4) | 0.001 | 0.433 | | 1 |
| F_fleet_4_YR_2011_s_1 | 0.0027 | (0,4) | 0.001 | 0.375 | | 1 |
| F_fleet_4_YR_2012_s_1 | 0.0025 | (0,4) | 0.001 | 0.403 | | 1 |
| F_fleet_4_YR_2013_s_1 | 0.0031 | (0,4) | 0.001 | 0.322 | | 1 |
| F_fleet_4_YR_2014_s_1 | 0.0053 | (0,4) | 0.001 | 0.189 | | 1 |
| F_fleet_4_YR_2015_s_1 | 0.0075 | (0,4) | 0.002 | 0.266 | | 1 |
| F_fleet_4_YR_2016_s_1 | 0.0048 | (0,4) | 0.001 | 0.208 | | 1 |
| F_fleet_4_YR_2017_s_1 | 0.0038 | (0,4) | 0.001 | 0.264 | | 1 |
| LnQ_base_ComVL(1) | -7.2303 | (-25,25) | | | | -4 |
| LnQ_base_Headboat(4) | -6.271 | (-25,25) | | | | -4 |

Table 10 Continued. List of SS parameters for Gulf of Mexico Scamp.

| Label | Value | Range | SD | CV | Prior | Phase |
|---|---------|----------|-------|--------|-------|-------|
| LnQ_base_Combined_Video(5) | -7.3812 | (-25,25) | | | | -1 |
| LnQ_base_RFOP_Index(6) | -6.847 | (-25,25) | | | | -1 |
| Size_inflection_ComVL(1) | 40.0072 | (10,85) | 0.368 | 0.009 | | 2 |
| Size_95%width_ComVL(1) | 10.4992 | (0,50) | 0.509 | 0.048 | | 2 |
| Retain_L_infl_ComVL(1) | 0 | (0,85) | | | | -3 |
| Retain_L_width_ComVL(1) | 1 | (0,20) | | | | -3 |
| Retain_L_asymptote_logit_ComVL(1) | 10 | (-10,10) | | | | -2 |
| Retain_L_maleoffset_ComVL(1) | 0 | (-1,2) | | | | -4 |
| DiscMort_L_infl_ComVL(1) | -5 | (-10,10) | | | | -2 |
| DiscMort_L_width_ComVL(1) | 1 | (-1,2) | | | | -4 |
| DiscMort_L_level_old_ComVL(1) | 0.47 | (-1,2) | | | | -2 |
| DiscMort_L_male_offset_ComVL(1) | 0 | (-1,2) | | | | -4 |
| Size_inflection_ComLL(2) | 48.3919 | (10,85) | 0.345 | 0.007 | | 2 |
| Size_95%width_ComLL(2) | 11.2604 | (0,50) | 0.346 | 0.031 | | 2 |
| Retain_L_infl_ComLL(2) | 0 | (0,85) | | | | -3 |
| Retain_L_width_ComLL(2) | 1 | (0,20) | | | | -3 |
| Retain_L_asymptote_logit_ComLL(2) | 10 | (-10,10) | | | | -2 |
| Retain_L_maleoffset_ComLL(2) | 0 | (-1,2) | | | | -4 |
| DiscMort_L_infl_ComLL(2) | -5 | (-10,10) | | | | -2 |
| DiscMort_L_width_ComLL(2) | 1 | (-1,2) | | | | -4 |
| DiscMort_L_level_old_ComLL(2) | 0.68 | (-1,2) | | | | -2 |
| DiscMort_L_male_offset_ComLL(2) | 0 | (-1,2) | | | | -4 |
| Size_DblN_peak_Charter_Private(3) | 31.0712 | (10,85) | 1.096 | 0.035 | | 2 |
| Size_DblN_top_logit_Charter_Private(3) | -2.235 | (-15,15) | 0.193 | -0.086 | | 3 |
| Size_DblN_ascend_se_Charter_Private(3) | 2.4314 | (-15,15) | 0.579 | 0.238 | | 3 |
| Size_DblN_descend_se_Charter_Private(3) | 3.536 | (-15,15) | 0.517 | 0.146 | | 3 |
| Size_DblN_start_logit_Charter_Private(3) | -6.0609 | (-15,15) | 1.171 | -0.193 | | 2 |
| Size_DblN_end_logit_Charter_Private(3) | -0.0118 | (-15,15) | 0.135 | -11.46 | | 4 |
| Retain_L_infl_Charter_Private(3) | 31 | (10,85) | | | | -3 |
| Retain_L_width_Charter_Private(3) | 0.5 | (0,20) | | | | -3 |
| Retain_L_asymptote_logit_Charter_Private(3) | 10 | (-10,10) | | | | -2 |
| Retain_L_maleoffset_Charter_Private(3) | 0 | (-1,2) | | | | -4 |
| DiscMort_L_infl_Charter_Private(3) | -5 | (-10,10) | | | | -2 |

Table 10 Continued. List of SS parameters for Gulf of Mexico Scamp.

| Label | Value | Range | SD | CV | Prior | Phase |
|---|---------|----------|---------|----------|-----------------|-------|
| DiscMort_L_width_Charter_Private(3) | 1 | (-1,2) | | | | -4 |
| DiscMort_L_level_old_Charter_Private(3) | 0.26 | (-1,2) | | | | -2 |
| DiscMort_L_male_offset_Charter_Private(3) | 0 | (-1,2) | | | | -4 |
| Size_DbIN_peak_Headboat(4) | 39.257 | (10,85) | 1.019 | 0.026 | | 2 |
| Size_DbIN_top_logit_Headboat(4) | -3.2605 | (-15,15) | 42.074 | -12.904 | | 3 |
| Size_DbIN_ascend_se_Headboat(4) | 4.2065 | (-15,15) | 0.175 | 0.042 | | 3 |
| Size_DbIN_descend_se_Headboat(4) | -0.4363 | (-15,15) | 252.695 | -579.212 | | 3 |
| Size_DbIN_start_logit_Headboat(4) | -6.8236 | (-15,15) | 0.941 | -0.138 | | 2 |
| Size_DbIN_end_logit_Headboat(4) | -0.3805 | (-15,15) | 0.103 | -0.271 | | 4 |
| Retain_L_infl_Headboat(4) | 0 | (0,85) | | | | -3 |
| Retain_L_width_Headboat(4) | 1 | (0,20) | | | | -3 |
| Retain_L_asymptote_logit_Headboat(4) | 10 | (-10,10) | | | | -2 |
| Retain_L_maleoffset_Headboat(4) | 0 | (-1,2) | | | | -4 |
| DiscMort_L_infl_Headboat(4) | -5 | (-10,10) | | | | -2 |
| DiscMort_L_width_Headboat(4) | 1 | (-1,2) | | | | -4 |
| DiscMort_L_level_old_Headboat(4) | 0.26 | (-1,2) | | | | -2 |
| DiscMort_L_male_offset_Headboat(4) | 0 | (-1,2) | | | | -4 |
| Size_inflection_Combined_Video(5) | 27.959 | (10,85) | 0.426 | 0.015 | | 2 |
| Size_95%width_Combined_Video(5) | 7.774 | (0,50) | 0.577 | 0.074 | | 2 |
| Size_inflection_RFOP_Index(6) | 37.219 | (10,85) | 0.335 | 0.009 | | 2 |
| Size_95%width_RFOP_Index(6) | 8.3436 | (0,50) | 0.467 | 0.056 | | 2 |
| ln(DM_theta)_1 | 5.7358 | (-5,10) | 0.693 | 0.121 | Normal (0,1.81) | 6 |
| ln(DM_theta)_2 | 5.7682 | (-5,10) | 0.694 | 0.12 | Normal (0,1.81) | 6 |
| ln(DM_theta)_3 | 5.5604 | (-5,10) | 0.701 | 0.126 | Normal (0,1.81) | 6 |
| ln(DM_theta)_4 | 5.5014 | (-5,10) | 0.693 | 0.126 | Normal (0,1.81) | 6 |
| ln(DM_theta)_5 | 5.0597 | (-5,10) | 0.73 | 0.144 | Normal (0,1.81) | 6 |
| ln(DM_theta)_6 | -1.4495 | (-5,10) | 0.075 | -0.052 | Normal (0,1.81) | 6 |
| ln(DM_theta)_7 | 5.4746 | (-5,10) | 0.595 | 0.109 | Normal (0,1.81) | 6 |
| ln(DM_theta)_8 | 4.8751 | (-5,10) | 0.569 | 0.117 | Normal (0,1.81) | 6 |
| ln(DM_theta)_9 | 0.8248 | (-5,10) | 0.209 | 0.253 | Normal (0,1.81) | 6 |
| ln(DM_theta)_10 | 0.5138 | (-5,10) | 0.194 | 0.378 | Normal (0,1.81) | 6 |
| Retain_L_infl_ComVL(1)_BLK1repl_1990 | 46.986 | (10,85) | | | | -3 |
| Retain_L_infl_ComVL(1)_BLK1repl_1999 | 30.697 | (10,85) | 2.793 | 0.091 | | 3 |

Table 10 Continued. List of SS parameters for Gulf of Mexico Scamp.

| Label | Value | Range | SD | CV | Prior | Phase |
|---|---------|----------|--------|-------|-------|-------|
| Retain_L_infl_ComVL(1)_BLK1repl_2003 | 37.9436 | (10,85) | | | | -3 |
| Retain_L_infl_ComVL(1)_BLK1repl_2010 | 37.9436 | (10,85) | | | | -3 |
| Retain_L_width_ComVL(1)_BLK1repl_1990 | 10.1285 | (0,20) | 1.063 | 0.105 | | 3 |
| Retain_L_width_ComVL(1)_BLK1repl_1999 | 4.8259 | (0,20) | 2.159 | 0.447 | | 3 |
| Retain_L_width_ComVL(1)_BLK1repl_2003 | 1.5608 | (0,20) | 0.229 | 0.147 | | 3 |
| Retain_L_width_ComVL(1)_BLK1repl_2010 | 1.4667 | (0,20) | 0.203 | 0.138 | | 3 |
| Retain_L_asymptote_logit_ComVL(1)_BLK1repl_1990 | 10 | (-10,10) | | | | -3 |
| Retain_L_asymptote_logit_ComVL(1)_BLK1repl_1999 | 10 | (-10,10) | | | | -3 |
| Retain_L_asymptote_logit_ComVL(1)_BLK1repl_2003 | 10 | (-10,10) | | | | -3 |
| Retain_L_asymptote_logit_ComVL(1)_BLK1repl_2010 | 4.1193 | (-10,10) | 0.295 | 0.072 | | 3 |
| Retain_L_infl_ComLL(2)_BLK1repl_1990 | 46.986 | (10,85) | | | | -3 |
| Retain_L_infl_ComLL(2)_BLK1repl_1999 | 35.6591 | (10,85) | 0.845 | 0.024 | | 3 |
| Retain_L_infl_ComLL(2)_BLK1repl_2003 | 37.9436 | (10,85) | | | | -3 |
| Retain_L_infl_ComLL(2)_BLK1repl_2010 | 37.9436 | (10,85) | | | | -3 |
| Retain_L_width_ComLL(2)_BLK1repl_1990 | 10.7935 | (0,20) | 2.739 | 0.254 | | 3 |
| Retain_L_width_ComLL(2)_BLK1repl_1999 | 1.2092 | (0,20) | 0.637 | 0.527 | | 3 |
| Retain_L_width_ComLL(2)_BLK1repl_2003 | 1.3746 | (0,20) | 0.356 | 0.259 | | 3 |
| Retain_L_width_ComLL(2)_BLK1repl_2010 | 2.1969 | (0,20) | 0.217 | 0.099 | | 3 |
| Retain_L_asymptote_logit_ComLL(2)_BLK1repl_1990 | 10 | (-10,10) | | | | -3 |
| Retain_L_asymptote_logit_ComLL(2)_BLK1repl_1999 | 10 | (-10,10) | | | | -3 |
| Retain_L_asymptote_logit_ComLL(2)_BLK1repl_2003 | 10 | (-10,10) | | | | -3 |
| Retain_L_asymptote_logit_ComLL(2)_BLK1repl_2010 | 5.9806 | (-10,10) | 0.592 | 0.099 | | 3 |
| Retain_L_infl_Charter_Private(3)_BLK2repl_1990 | 46.986 | (10,85) | | | | -3 |
| Retain_L_infl_Charter_Private(3)_BLK2repl_1999 | 42.3596 | (10,85) | 0.918 | 0.022 | | 3 |
| Retain_L_infl_Charter_Private(3)_BLK2repl_2003 | 37.9436 | (10,85) | | | | -3 |
| Retain_L_width_Charter_Private(3)_BLK2repl_1990 | 4.9703 | (0,20) | 0.515 | 0.104 | | 3 |
| Retain_L_width_Charter_Private(3)_BLK2repl_1999 | 2.7938 | (0,20) | 0.392 | 0.14 | | 3 |
| Retain_L_width_Charter_Private(3)_BLK2repl_2003 | 0.2194 | (0,20) | 0.024 | 0.109 | | 3 |
| Retain_L_asymptote_logit_Charter_Private(3)_BLK2repl_1990 | 9.6063 | (-10,10) | 10.577 | 1.101 | | 3 |
| Retain_L_asymptote_logit_Charter_Private(3)_BLK2repl_1999 | 9.0425 | (-10,10) | 21.895 | 2.421 | | 3 |
| Retain_L_asymptote_logit_Charter_Private(3)_BLK2repl_2003 | 2.4295 | (-10,10) | 0.513 | 0.211 | | 3 |
| Retain_L_infl_Headboat(4)_BLK2repl_1990 | 46.986 | (10,85) | | | | -3 |
| Retain_L_infl_Headboat(4)_BLK2repl_1999 | 37.191 | (10,85) | 0.951 | 0.026 | | 3 |

Table 10 Continued. List of SS parameters for Gulf of Mexico Scamp.

| Label | Value | Range | SD | CV | Prior | Phase |
|--|---------|----------|--------|-------|-------|-------|
| Retain_L_infl_Headboat(4)_BLK2repl_2003 | 37.9436 | (10,85) | | | | -3 |
| Retain_L_width_Headboat(4)_BLK2repl_1990 | 16.5925 | (0,20) | 3.271 | 0.197 | | 3 |
| Retain_L_width_Headboat(4)_BLK2repl_1999 | 1.7078 | (0,20) | 0.527 | 0.309 | | 3 |
| Retain_L_width_Headboat(4)_BLK2repl_2003 | 0.1993 | (0,20) | 0.024 | 0.12 | | 3 |
| Retain_L_asymptote_logit_Headboat(4)_BLK2repl_1990 | 9.5144 | (-10,10) | 12.651 | 1.33 | | 3 |
| Retain_L_asymptote_logit_Headboat(4)_BLK2repl_1999 | 0.47 | (-10,10) | 0.383 | 0.815 | | 3 |
| Retain_L_asymptote_logit_Headboat(4)_BLK2repl_2003 | 2.5955 | (-10,10) | 0.233 | 0.09 | | 3 |

Table 11. Estimates of annual exploitation rate (total biomass killed age 3+ / total biomass age 3+) by fleet and combined across all fleets (Total) for Gulf of Mexico Scamp, which was used as the proxy for annual fishing mortality rate.

| Year | Commercial Vertical Line | Commercial Longline | Recreational Charter Private | Recreational Headboat | Total |
|------|--------------------------|---------------------|------------------------------|-----------------------|-------|
| 1986 | 0.044 | 0.042 | 0.048 | 0.004 | 0.139 |
| 1987 | 0.046 | 0.038 | 0.045 | 0.003 | 0.133 |
| 1988 | 0.041 | 0.028 | 0.037 | 0.002 | 0.108 |
| 1989 | 0.043 | 0.033 | 0.019 | 0.006 | 0.102 |
| 1990 | 0.053 | 0.037 | 0.010 | 0.002 | 0.102 |
| 1991 | 0.064 | 0.045 | 0.012 | 0.002 | 0.124 |
| 1992 | 0.078 | 0.026 | 0.020 | 0.001 | 0.125 |
| 1993 | 0.073 | 0.035 | 0.035 | 0.001 | 0.145 |
| 1994 | 0.054 | 0.019 | 0.014 | 0.001 | 0.089 |
| 1995 | 0.056 | 0.019 | 0.004 | 0.001 | 0.080 |
| 1996 | 0.051 | 0.020 | 0.007 | 0.001 | 0.079 |
| 1997 | 0.062 | 0.023 | 0.016 | 0.001 | 0.101 |
| 1998 | 0.038 | 0.024 | 0.012 | 0.001 | 0.076 |
| 1999 | 0.037 | 0.018 | 0.020 | 0.001 | 0.076 |
| 2000 | 0.026 | 0.015 | 0.012 | 0.001 | 0.054 |
| 2001 | 0.030 | 0.021 | 0.015 | 0.000 | 0.067 |
| 2002 | 0.035 | 0.022 | 0.013 | 0.000 | 0.069 |
| 2003 | 0.031 | 0.024 | 0.040 | 0.000 | 0.094 |
| 2004 | 0.029 | 0.026 | 0.042 | 0.001 | 0.097 |
| 2005 | 0.028 | 0.024 | 0.018 | 0.000 | 0.071 |

Table 11 Continued. Estimates of annual exploitation rate (total biomass killed age 3+ / total biomass age 3+) by fleet and combined across all fleets (Total) for Gulf of Mexico Scamp, which was used as the proxy for annual fishing mortality rate.

| Year | Commercial Vertical Line | Commercial Longline | Recreational Charter Private | Recreational Headboat | Total |
|------|--------------------------|---------------------|------------------------------|-----------------------|-------|
| 2006 | 0.022 | 0.014 | 0.026 | 0.000 | 0.062 |
| 2007 | 0.025 | 0.019 | 0.028 | 0.000 | 0.073 |
| 2008 | 0.023 | 0.023 | 0.048 | 0.001 | 0.094 |
| 2009 | 0.028 | 0.015 | 0.041 | 0.001 | 0.085 |
| 2010 | 0.017 | 0.012 | 0.037 | 0.001 | 0.066 |
| 2011 | 0.016 | 0.011 | 0.021 | 0.001 | 0.050 |
| 2012 | 0.030 | 0.018 | 0.060 | 0.001 | 0.109 |
| 2013 | 0.030 | 0.021 | 0.043 | 0.001 | 0.096 |
| 2014 | 0.024 | 0.014 | 0.075 | 0.002 | 0.115 |
| 2015 | 0.024 | 0.020 | 0.084 | 0.003 | 0.131 |
| 2016 | 0.039 | 0.039 | 0.059 | 0.002 | 0.139 |
| 2017 | 0.025 | 0.022 | 0.060 | 0.001 | 0.109 |

Table 12. Expected biomass (metric tons) for all Scamp and exploited Scamp (3+ years), spawning stock biomass (SSB, metric tons), exploited numbers (3+years, 1,000s of fish), age-0 recruits (1,000s of fish), and SSB ratio (SSB/SSB_0) where $SSB_0 = 3,910$ metric tons for Gulf of Mexico Scamp.

| Year | Biomass (all) | Biomass (exploited) | SSB | Abundance | Recruits | SSB ratio |
|------|---------------|---------------------|-------|-----------|----------|-----------|
| 1986 | 1,957 | 1,885 | 1,746 | 2,047.47 | 860.73 | 0.45 |
| 1987 | 1,890 | 1,825 | 1,687 | 2,006.84 | 1,154.56 | 0.43 |
| 1988 | 1,824 | 1,784 | 1,646 | 1,984.56 | 1,221.80 | 0.42 |
| 1989 | 1,789 | 1,737 | 1,632 | 1,739.37 | 2,193.51 | 0.42 |
| 1990 | 1,766 | 1,704 | 1,609 | 1,660.36 | 2,503.98 | 0.41 |
| 1991 | 1,771 | 1,674 | 1,577 | 1,634.88 | 1,844.34 | 0.40 |
| 1992 | 1,775 | 1,674 | 1,535 | 1,896.38 | 2,318.67 | 0.39 |
| 1993 | 1,799 | 1,716 | 1,537 | 2,181.64 | 1,693.94 | 0.39 |
| 1994 | 1,808 | 1,715 | 1,544 | 2,173.40 | 1,641.25 | 0.40 |
| 1995 | 1,912 | 1,839 | 1,659 | 2,365.16 | 1,895.76 | 0.42 |
| 1996 | 2,017 | 1,944 | 1,781 | 2,330.68 | 1,982.90 | 0.46 |

Table 12 Continued. Expected biomass (metric tons) for all Scamp and exploited Scamp (3+ years), spawning stock biomass (SSB, metric tons), exploited numbers (3+years, 1,000s of fish), age-0 recruits (1,000s of fish), and SSB ratio (SSB/SSB₀) where SSB₀ = 3,910 metric tons for Gulf of Mexico Scamp.

| Year | Biomass (all) | Biomass (exploited) | SSB | Abundance | Recruits | SSB ratio |
|------|---------------|---------------------|-------|-----------|----------|-----------|
| 1997 | 2,114 | 2,032 | 1,884 | 2,291.27 | 1,789.85 | 0.48 |
| 1998 | 2,159 | 2,075 | 1,925 | 2,313.80 | 2,805.54 | 0.49 |
| 1999 | 2,249 | 2,163 | 2,005 | 2,385.60 | 2,067.49 | 0.51 |
| 2000 | 2,340 | 2,226 | 2,070 | 2,375.43 | 3,196.43 | 0.53 |
| 2001 | 2,483 | 2,384 | 2,192 | 2,706.17 | 2,052.96 | 0.56 |
| 2002 | 2,607 | 2,481 | 2,292 | 2,718.10 | 2,782.18 | 0.59 |
| 2003 | 2,728 | 2,634 | 2,410 | 3,074.24 | 1,608.91 | 0.62 |
| 2004 | 2,775 | 2,668 | 2,463 | 2,949.48 | 1,294.80 | 0.63 |
| 2005 | 2,791 | 2,725 | 2,513 | 3,076.17 | 1,238.75 | 0.64 |
| 2006 | 2,837 | 2,782 | 2,604 | 2,858.86 | 1,347.36 | 0.67 |
| 2007 | 2,860 | 2,806 | 2,668 | 2,605.95 | 1,433.38 | 0.68 |
| 2008 | 2,818 | 2,760 | 2,644 | 2,383.02 | 1,142.94 | 0.68 |
| 2009 | 2,695 | 2,636 | 2,525 | 2,212.18 | 1,080.74 | 0.65 |
| 2010 | 2,582 | 2,534 | 2,419 | 2,122.28 | 911.52 | 0.62 |
| 2011 | 2,501 | 2,457 | 2,351 | 1,986.10 | 880.37 | 0.60 |
| 2012 | 2,447 | 2,408 | 2,311 | 1,885.77 | 828.44 | 0.59 |
| 2013 | 2,241 | 2,203 | 2,118 | 1,685.24 | 1,613.55 | 0.54 |
| 2014 | 2,085 | 2,042 | 1,964 | 1,543.76 | 1,700.11 | 0.50 |
| 2015 | 1,917 | 1,847 | 1,775 | 1,394.73 | 1,663.98 | 0.45 |
| 2016 | 1,766 | 1,694 | 1,594 | 1,510.96 | 1,658.47 | 0.41 |
| 2017 | 1,658 | 1,587 | 1,462 | 1,629.44 | 1,653.63 | 0.37 |

Table 13. Expected female and male spawning stock biomass (SSB, metric tons), exploitable biomass (3+ years, metric tons), exploitable abundance (3+ years, 1,000s of fish), and the expected sex ratio (exploitable male:female) for Gulf of Mexico Scamp.

| Year | SSB (female) | SSB (male) | Biomass (female) | Biomass (male) | Abundance (female) | Abundance (male) | Sex ratio |
|------|-----------------|---------------|---------------------|-------------------|-----------------------|---------------------|--------------|
| 1986 | 1,218 | 528 | 1,357 | 528 | 1,815.61 | 231.86 | 12.8 |
| 1987 | 1,180 | 507 | 1,318 | 507 | 1,783.57 | 223.27 | 12.5 |
| 1988 | 1,155 | 491 | 1,293 | 491 | 1,767.65 | 216.91 | 12.3 |
| 1989 | 1,140 | 491 | 1,246 | 491 | 1,522.14 | 217.23 | 14.3 |
| 1990 | 1,115 | 493 | 1,211 | 493 | 1,444.14 | 216.22 | 15.0 |
| 1991 | 1,086 | 490 | 1,184 | 490 | 1,421.16 | 213.72 | 15.0 |
| 1992 | 1,061 | 473 | 1,200 | 473 | 1,690.50 | 205.88 | 12.2 |
| 1993 | 1,081 | 456 | 1,259 | 456 | 1,980.62 | 201.02 | 10.1 |
| 1994 | 1,116 | 427 | 1,287 | 427 | 1,977.92 | 195.48 | 9.9 |
| 1995 | 1,222 | 437 | 1,402 | 437 | 2,160.10 | 205.06 | 9.5 |
| 1996 | 1,325 | 455 | 1,489 | 455 | 2,111.81 | 218.87 | 10.4 |
| 1997 | 1,404 | 480 | 1,552 | 480 | 2,058.34 | 232.93 | 11.3 |
| 1998 | 1,429 | 495 | 1,580 | 495 | 2,073.78 | 240.02 | 11.6 |
| 1999 | 1,474 | 530 | 1,632 | 530 | 2,131.71 | 253.89 | 11.9 |
| 2000 | 1,502 | 568 | 1,657 | 568 | 2,108.27 | 267.16 | 12.7 |
| 2001 | 1,569 | 622 | 1,762 | 622 | 2,420.69 | 285.48 | 11.8 |
| 2002 | 1,627 | 664 | 1,817 | 664 | 2,416.50 | 301.60 | 12.5 |
| 2003 | 1,706 | 703 | 1,931 | 703 | 2,758.53 | 315.71 | 11.4 |
| 2004 | 1,743 | 720 | 1,947 | 720 | 2,625.88 | 323.60 | 12.3 |
| 2005 | 1,779 | 733 | 1,991 | 733 | 2,747.56 | 328.61 | 12.0 |
| 2006 | 1,835 | 769 | 2,013 | 769 | 2,514.72 | 344.14 | 13.7 |
| 2007 | 1,852 | 815 | 1,990 | 815 | 2,246.18 | 359.77 | 16.0 |
| 2008 | 1,794 | 850 | 1,910 | 850 | 2,016.87 | 366.15 | 18.2 |
| 2009 | 1,665 | 859 | 1,776 | 859 | 1,852.51 | 359.66 | 19.4 |
| 2010 | 1,547 | 871 | 1,662 | 871 | 1,768.81 | 353.46 | 20.0 |
| 2011 | 1,457 | 893 | 1,563 | 893 | 1,634.17 | 351.93 | 21.5 |
| 2012 | 1,389 | 922 | 1,486 | 922 | 1,532.41 | 353.36 | 23.1 |

Table 13 Continued. Expected female and male spawning stock biomass (SSB, metric tons), exploitable biomass (3+ years, metric tons), exploitable abundance (3+ years, 1,000s of fish), and the expected sex ratio (exploitable male:female) for Gulf of Mexico Scamp.

| Year | SSB (female) | SSB (male) | Biomass (female) | Biomass (male) | Abundance (female) | Abundance (male) | Sex ratio |
|------|-----------------|---------------|---------------------|-------------------|-----------------------|---------------------|--------------|
| 2013 | 1,238 | 880 | 1,323 | 880 | 1,355.92 | 329.32 | 24.3 |
| 2014 | 1,120 | 844 | 1,197 | 844 | 1,234.49 | 309.26 | 25.1 |
| 2015 | 987 | 787 | 1,059 | 787 | 1,112.02 | 282.71 | 25.4 |
| 2016 | 880 | 714 | 980 | 714 | 1,258.64 | 252.32 | 20.0 |
| 2017 | 831 | 631 | 955 | 631 | 1,404.71 | 224.73 | 16.0 |

Table 14A. Expected numbers-at-age (1,000s of fish) at the beginning of the year (January 1st) for female Scamp in the Gulf of Mexico.

| Year | 0 | 1 | 2 | 3 | 4 | 5 | 6 | 7 |
|------|-----------|-----------|-----------|---------|---------|---------|---------|---------|
| 1986 | 860.733 | 1,026.770 | 705.006 | 516.955 | 382.756 | 279.898 | 201.518 | 142.773 |
| 1987 | 1,154.560 | 522.620 | 704.982 | 516.772 | 379.893 | 273.632 | 195.151 | 137.672 |
| 1988 | 1,221.800 | 701.030 | 358.833 | 516.787 | 380.347 | 272.815 | 191.921 | 134.156 |
| 1989 | 2,193.510 | 741.861 | 481.340 | 263.090 | 381.809 | 276.379 | 194.771 | 134.868 |
| 1990 | 2,503.980 | 1,331.890 | 509.378 | 352.908 | 195.371 | 281.662 | 200.882 | 139.171 |
| 1991 | 1,844.340 | 1,520.420 | 914.531 | 373.578 | 263.670 | 146.973 | 209.843 | 146.657 |
| 1992 | 2,318.670 | 1,119.890 | 1,043.970 | 670.640 | 278.761 | 197.574 | 108.616 | 151.219 |
| 1993 | 1,693.940 | 1,407.880 | 768.937 | 765.439 | 499.119 | 207.532 | 144.562 | 77.342 |
| 1994 | 1,641.250 | 1,028.530 | 966.653 | 563.642 | 566.868 | 367.360 | 149.312 | 100.679 |
| 1995 | 1,895.760 | 996.567 | 706.224 | 708.906 | 420.633 | 425.372 | 272.812 | 108.706 |
| 1996 | 1,982.900 | 1,151.120 | 684.289 | 517.980 | 530.573 | 317.603 | 318.373 | 200.327 |
| 1997 | 1,789.850 | 1,204.030 | 790.415 | 501.897 | 387.476 | 400.414 | 237.870 | 234.264 |
| 1998 | 2,805.540 | 1,086.790 | 826.724 | 579.628 | 374.346 | 290.244 | 296.220 | 172.066 |
| 1999 | 2,067.490 | 1,703.530 | 746.245 | 606.376 | 433.232 | 282.271 | 217.661 | 218.873 |
| 2000 | 3,196.430 | 1,255.370 | 1,169.730 | 547.347 | 452.750 | 325.592 | 210.232 | 159.367 |
| 2001 | 2,052.960 | 1,940.880 | 862.016 | 858.091 | 409.662 | 342.576 | 245.606 | 156.865 |
| 2002 | 2,782.180 | 1,246.560 | 1,332.720 | 632.320 | 641.615 | 309.131 | 257.011 | 181.623 |
| 2003 | 1,608.910 | 1,689.350 | 855.960 | 977.602 | 472.986 | 484.403 | 231.911 | 189.912 |
| 2004 | 1,294.800 | 976.905 | 1,159.970 | 627.735 | 727.701 | 352.716 | 353.955 | 165.229 |
| 2005 | 1,238.750 | 786.183 | 670.778 | 850.675 | 467.130 | 542.284 | 257.412 | 251.753 |
| 2006 | 1,347.360 | 752.169 | 539.837 | 492.047 | 636.209 | 352.611 | 405.483 | 189.160 |
| 2007 | 1,433.380 | 818.108 | 516.479 | 395.987 | 367.586 | 479.272 | 263.192 | 298.191 |
| 2008 | 1,142.940 | 870.337 | 561.754 | 378.838 | 295.662 | 276.445 | 356.339 | 192.319 |
| 2009 | 1,080.740 | 693.970 | 597.604 | 411.968 | 281.732 | 220.142 | 201.788 | 254.147 |
| 2010 | 911.515 | 656.210 | 476.507 | 438.283 | 306.731 | 210.372 | 161.552 | 145.021 |
| 2011 | 880.370 | 553.459 | 450.584 | 349.498 | 326.637 | 229.787 | 155.602 | 117.611 |
| 2012 | 828.441 | 534.558 | 380.038 | 330.538 | 261.316 | 246.726 | 172.602 | 115.632 |
| 2013 | 1,613.550 | 503.003 | 367.039 | 278.650 | 244.918 | 192.707 | 176.826 | 120.165 |
| 2014 | 1,700.110 | 979.717 | 345.379 | 269.167 | 207.228 | 182.285 | 140.463 | 125.832 |
| 2015 | 1,663.980 | 1,032.240 | 672.683 | 253.200 | 198.791 | 151.607 | 128.839 | 96.168 |
| 2016 | 1,658.470 | 1,010.280 | 708.733 | 493.086 | 186.552 | 144.510 | 105.822 | 86.681 |
| 2017 | 1,653.630 | 1,006.970 | 693.671 | 519.601 | 364.985 | 137.030 | 102.481 | 72.297 |

Table 14A Continued. Expected numbers-at-age (1,000s of fish) at the beginning of the year (January 1st) for female Scamp in the Gulf of Mexico.

| Year | 8 | 9 | 10 | 11 | 12 | 13 | 14 | 15 |
|------|---------|---------|---------|--------|--------|--------|--------|--------|
| 1986 | 99.506 | 68.166 | 45.824 | 30.158 | 19.375 | 12.110 | 7.337 | 4.291 |
| 1987 | 95.784 | 65.558 | 44.040 | 28.966 | 18.599 | 11.620 | 7.037 | 4.114 |
| 1988 | 92.934 | 63.497 | 42.622 | 28.018 | 17.982 | 11.229 | 6.798 | 3.973 |
| 1989 | 92.873 | 63.339 | 42.523 | 27.971 | 17.961 | 11.220 | 6.794 | 3.971 |
| 1990 | 94.671 | 63.986 | 42.767 | 28.082 | 18.019 | 11.251 | 6.810 | 3.980 |
| 1991 | 99.126 | 65.699 | 43.241 | 28.121 | 17.938 | 11.156 | 6.732 | 3.924 |
| 1992 | 102.629 | 67.324 | 43.320 | 27.677 | 17.454 | 10.777 | 6.471 | 3.758 |
| 1993 | 104.591 | 69.003 | 44.031 | 27.549 | 17.092 | 10.445 | 6.231 | 3.602 |
| 1994 | 52.077 | 68.207 | 43.645 | 27.020 | 16.388 | 9.839 | 5.803 | 3.331 |
| 1995 | 71.638 | 36.192 | 46.269 | 28.864 | 17.386 | 10.233 | 5.943 | 3.378 |
| 1996 | 78.015 | 50.195 | 24.742 | 30.827 | 18.707 | 10.933 | 6.224 | 3.483 |
| 1997 | 144.239 | 54.893 | 34.483 | 16.574 | 20.094 | 11.834 | 6.690 | 3.671 |
| 1998 | 165.196 | 99.129 | 36.762 | 22.485 | 10.505 | 12.350 | 7.032 | 3.829 |
| 1999 | 124.722 | 117.235 | 68.774 | 24.891 | 14.823 | 6.724 | 7.650 | 4.199 |
| 2000 | 157.365 | 88.075 | 81.246 | 46.683 | 16.502 | 9.566 | 4.208 | 4.623 |
| 2001 | 117.297 | 114.077 | 62.761 | 56.762 | 31.875 | 10.972 | 6.170 | 2.621 |
| 2002 | 114.054 | 83.786 | 79.954 | 43.071 | 38.036 | 20.787 | 6.938 | 3.766 |
| 2003 | 131.852 | 81.288 | 58.562 | 54.698 | 28.764 | 24.716 | 13.094 | 4.219 |
| 2004 | 132.721 | 90.676 | 54.980 | 38.858 | 35.487 | 18.178 | 15.153 | 7.754 |
| 2005 | 115.244 | 91.074 | 61.183 | 36.388 | 25.142 | 22.364 | 11.112 | 8.947 |
| 2006 | 181.822 | 81.814 | 63.476 | 41.770 | 24.262 | 16.317 | 14.072 | 6.751 |
| 2007 | 137.302 | 130.299 | 57.770 | 44.023 | 28.349 | 16.049 | 10.476 | 8.729 |
| 2008 | 214.639 | 97.433 | 91.010 | 39.603 | 29.516 | 18.518 | 10.172 | 6.414 |
| 2009 | 134.967 | 148.672 | 66.528 | 61.066 | 26.012 | 18.900 | 11.510 | 6.109 |
| 2010 | 179.983 | 94.429 | 102.613 | 45.149 | 40.587 | 16.860 | 11.894 | 7.001 |
| 2011 | 104.424 | 128.348 | 66.533 | 71.161 | 30.685 | 26.913 | 10.858 | 7.405 |
| 2012 | 86.548 | 76.041 | 92.232 | 47.010 | 49.238 | 20.704 | 17.631 | 6.875 |
| 2013 | 79.165 | 58.599 | 50.875 | 60.762 | 30.363 | 31.036 | 12.678 | 10.438 |
| 2014 | 84.118 | 54.700 | 39.922 | 34.067 | 39.837 | 19.409 | 19.260 | 7.603 |
| 2015 | 84.844 | 56.264 | 36.259 | 26.116 | 21.883 | 25.001 | 11.842 | 11.367 |
| 2016 | 63.585 | 55.615 | 36.546 | 23.242 | 16.438 | 13.456 | 14.945 | 6.847 |
| 2017 | 57.792 | 41.662 | 35.837 | 23.107 | 14.371 | 9.901 | 7.863 | 8.435 |

Table 14A Continued. Expected numbers-at-age (1,000s of fish) at the beginning of the year (January 1st) for female Scamp in the Gulf of Mexico.

| Year | 16 | 17 | 18 | 19 | 20+ |
|------|-------|-------|-------|-------|-------|
| 1986 | 2.411 | 1.296 | 0.663 | 0.321 | 0.247 |
| 1987 | 2.312 | 1.242 | 0.636 | 0.308 | 0.237 |
| 1988 | 2.232 | 1.199 | 0.613 | 0.297 | 0.229 |
| 1989 | 2.231 | 1.199 | 0.613 | 0.297 | 0.229 |
| 1990 | 2.235 | 1.201 | 0.614 | 0.297 | 0.229 |
| 1991 | 2.200 | 1.180 | 0.603 | 0.291 | 0.224 |
| 1992 | 2.100 | 1.124 | 0.573 | 0.277 | 0.212 |
| 1993 | 2.006 | 1.071 | 0.545 | 0.262 | 0.201 |
| 1994 | 1.846 | 0.981 | 0.497 | 0.239 | 0.182 |
| 1995 | 1.861 | 0.985 | 0.498 | 0.239 | 0.182 |
| 1996 | 1.900 | 1.000 | 0.503 | 0.241 | 0.182 |
| 1997 | 1.972 | 1.028 | 0.514 | 0.245 | 0.185 |
| 1998 | 2.016 | 1.034 | 0.512 | 0.243 | 0.182 |
| 1999 | 2.195 | 1.104 | 0.539 | 0.253 | 0.188 |
| 2000 | 2.439 | 1.220 | 0.584 | 0.270 | 0.199 |
| 2001 | 2.769 | 1.398 | 0.666 | 0.302 | 0.218 |
| 2002 | 1.538 | 1.554 | 0.747 | 0.337 | 0.237 |
| 2003 | 2.202 | 0.860 | 0.827 | 0.376 | 0.260 |
| 2004 | 2.402 | 1.199 | 0.446 | 0.406 | 0.282 |
| 2005 | 4.402 | 1.305 | 0.620 | 0.218 | 0.304 |
| 2006 | 5.225 | 2.459 | 0.694 | 0.312 | 0.233 |
| 2007 | 4.028 | 2.983 | 1.337 | 0.357 | 0.251 |
| 2008 | 5.139 | 2.269 | 1.600 | 0.679 | 0.278 |
| 2009 | 3.705 | 2.841 | 1.194 | 0.797 | 0.435 |
| 2010 | 3.574 | 2.075 | 1.515 | 0.603 | 0.568 |
| 2011 | 4.193 | 2.050 | 1.133 | 0.784 | 0.545 |
| 2012 | 4.510 | 2.444 | 1.138 | 0.596 | 0.629 |
| 2013 | 3.916 | 2.459 | 1.269 | 0.560 | 0.537 |
| 2014 | 6.021 | 2.162 | 1.293 | 0.632 | 0.486 |
| 2015 | 4.319 | 3.275 | 1.120 | 0.635 | 0.491 |
| 2016 | 6.326 | 2.302 | 1.662 | 0.539 | 0.486 |
| 2017 | 3.715 | 3.284 | 1.137 | 0.778 | 0.429 |

Table 14B. Expected biomass-at-age (metric tons) at the beginning of the year (January 1st) for female Scamp in the Gulf of Mexico.

| Year | 0 | 1 | 2 | 3 | 4 | 5 | 6 | 7 |
|------|-------|--------|---------|---------|---------|---------|---------|---------|
| 1986 | 0.988 | 15.172 | 55.303 | 105.653 | 149.139 | 174.545 | 179.949 | 169.133 |
| 1987 | 1.325 | 7.722 | 55.301 | 105.616 | 148.023 | 170.637 | 174.264 | 163.090 |
| 1988 | 1.402 | 10.358 | 28.148 | 105.619 | 148.200 | 170.128 | 171.379 | 158.925 |
| 1989 | 2.518 | 10.962 | 37.758 | 53.769 | 148.770 | 172.350 | 173.924 | 159.769 |
| 1990 | 2.874 | 19.680 | 39.957 | 72.126 | 76.125 | 175.645 | 179.381 | 164.866 |
| 1991 | 2.117 | 22.466 | 71.739 | 76.351 | 102.738 | 91.653 | 187.383 | 173.734 |
| 1992 | 2.661 | 16.548 | 81.893 | 137.063 | 108.618 | 123.207 | 96.990 | 179.138 |
| 1993 | 1.944 | 20.803 | 60.318 | 156.438 | 194.479 | 129.417 | 129.089 | 91.622 |
| 1994 | 1.884 | 15.198 | 75.828 | 115.195 | 220.877 | 229.085 | 133.331 | 119.267 |
| 1995 | 2.176 | 14.725 | 55.399 | 144.884 | 163.897 | 265.262 | 243.612 | 128.776 |
| 1996 | 2.276 | 17.009 | 53.678 | 105.863 | 206.735 | 198.057 | 284.297 | 237.313 |
| 1997 | 2.054 | 17.791 | 62.003 | 102.576 | 150.978 | 249.698 | 212.410 | 277.516 |
| 1998 | 3.220 | 16.059 | 64.851 | 118.462 | 145.862 | 180.996 | 264.515 | 203.834 |
| 1999 | 2.373 | 25.172 | 58.538 | 123.929 | 168.806 | 176.024 | 194.364 | 259.283 |
| 2000 | 3.669 | 18.549 | 91.757 | 111.865 | 176.412 | 203.039 | 187.730 | 188.790 |
| 2001 | 2.356 | 28.679 | 67.620 | 175.374 | 159.622 | 213.630 | 219.318 | 185.827 |
| 2002 | 3.193 | 18.419 | 104.543 | 129.231 | 250.002 | 192.774 | 229.502 | 215.156 |
| 2003 | 1.847 | 24.962 | 67.145 | 199.799 | 184.296 | 302.074 | 207.089 | 224.975 |
| 2004 | 1.486 | 14.435 | 90.992 | 128.294 | 283.545 | 219.954 | 316.070 | 195.735 |
| 2005 | 1.422 | 11.617 | 52.618 | 173.858 | 182.015 | 338.168 | 229.860 | 298.234 |
| 2006 | 1.546 | 11.114 | 42.347 | 100.563 | 247.895 | 219.888 | 362.083 | 224.085 |
| 2007 | 1.645 | 12.088 | 40.514 | 80.930 | 143.228 | 298.874 | 235.021 | 353.246 |
| 2008 | 1.312 | 12.860 | 44.066 | 77.426 | 115.203 | 172.391 | 318.199 | 227.826 |
| 2009 | 1.240 | 10.254 | 46.878 | 84.197 | 109.775 | 137.281 | 180.190 | 301.070 |
| 2010 | 1.046 | 9.696 | 37.379 | 89.575 | 119.516 | 131.188 | 144.261 | 171.796 |
| 2011 | 1.010 | 8.178 | 35.346 | 71.429 | 127.272 | 143.295 | 138.947 | 139.325 |
| 2012 | 0.951 | 7.899 | 29.811 | 67.554 | 101.820 | 153.858 | 154.128 | 136.980 |
| 2013 | 1.852 | 7.432 | 28.792 | 56.950 | 95.431 | 120.172 | 157.900 | 142.351 |
| 2014 | 1.951 | 14.476 | 27.093 | 55.011 | 80.745 | 113.673 | 125.429 | 149.065 |
| 2015 | 1.910 | 15.252 | 52.768 | 51.748 | 77.458 | 94.542 | 115.049 | 113.924 |
| 2016 | 1.904 | 14.928 | 55.596 | 100.775 | 72.689 | 90.116 | 94.496 | 102.685 |
| 2017 | 1.898 | 14.879 | 54.414 | 106.194 | 142.215 | 85.452 | 91.512 | 85.645 |

Table 14B Continued. Expected biomass-at-age (metric tons) at the beginning of the year (January 1st) for female Scamp in the Gulf of Mexico.

| Year | 8 | 9 | 10 | 11 | 12 | 13 | 14 | 15 |
|------|---------|---------|---------|---------|---------|--------|--------|--------|
| 1986 | 147.965 | 122.056 | 95.679 | 71.588 | 51.234 | 35.086 | 22.974 | 14.357 |
| 1987 | 142.431 | 117.387 | 91.955 | 68.759 | 49.182 | 33.666 | 22.035 | 13.767 |
| 1988 | 138.194 | 113.697 | 88.994 | 66.509 | 47.549 | 32.535 | 21.288 | 13.296 |
| 1989 | 138.102 | 113.412 | 88.786 | 66.397 | 47.495 | 32.508 | 21.274 | 13.289 |
| 1990 | 140.775 | 114.572 | 89.297 | 66.660 | 47.648 | 32.598 | 21.326 | 13.317 |
| 1991 | 147.401 | 117.639 | 90.287 | 66.753 | 47.433 | 32.322 | 21.081 | 13.132 |
| 1992 | 152.609 | 120.549 | 90.450 | 65.698 | 46.155 | 31.224 | 20.263 | 12.575 |
| 1993 | 155.527 | 123.555 | 91.934 | 65.396 | 45.197 | 30.261 | 19.512 | 12.055 |
| 1994 | 77.439 | 122.130 | 91.130 | 64.140 | 43.336 | 28.506 | 18.172 | 11.145 |
| 1995 | 106.526 | 64.804 | 96.609 | 68.518 | 45.975 | 29.648 | 18.608 | 11.303 |
| 1996 | 116.008 | 89.877 | 51.661 | 73.177 | 49.467 | 31.675 | 19.488 | 11.654 |
| 1997 | 214.484 | 98.290 | 72.000 | 39.342 | 53.135 | 34.286 | 20.950 | 12.283 |
| 1998 | 245.647 | 177.497 | 76.758 | 53.375 | 27.778 | 35.782 | 22.018 | 12.814 |
| 1999 | 185.461 | 209.918 | 143.598 | 59.085 | 39.198 | 19.481 | 23.954 | 14.050 |
| 2000 | 234.003 | 157.705 | 169.640 | 110.815 | 43.636 | 27.716 | 13.176 | 15.468 |
| 2001 | 174.421 | 204.264 | 131.044 | 134.742 | 84.288 | 31.790 | 19.320 | 8.771 |
| 2002 | 169.598 | 150.026 | 166.942 | 102.242 | 100.581 | 60.225 | 21.724 | 12.603 |
| 2003 | 196.064 | 145.552 | 122.276 | 129.842 | 76.062 | 71.610 | 41.003 | 14.118 |
| 2004 | 197.357 | 162.362 | 114.796 | 92.240 | 93.840 | 52.667 | 47.450 | 25.947 |
| 2005 | 171.368 | 163.076 | 127.749 | 86.377 | 66.484 | 64.793 | 34.797 | 29.938 |
| 2006 | 270.369 | 146.493 | 132.536 | 99.153 | 64.157 | 47.273 | 44.065 | 22.591 |
| 2007 | 204.168 | 233.310 | 120.622 | 104.503 | 74.964 | 46.499 | 32.802 | 29.210 |
| 2008 | 319.168 | 174.461 | 190.027 | 94.008 | 78.051 | 53.652 | 31.853 | 21.462 |
| 2009 | 200.697 | 266.208 | 138.909 | 144.959 | 68.784 | 54.757 | 36.040 | 20.442 |
| 2010 | 267.635 | 169.081 | 214.254 | 107.175 | 107.326 | 48.848 | 37.245 | 23.426 |
| 2011 | 155.279 | 229.816 | 138.919 | 168.921 | 81.140 | 77.974 | 34.002 | 24.780 |
| 2012 | 128.697 | 136.157 | 192.578 | 111.591 | 130.201 | 59.985 | 55.208 | 23.005 |
| 2013 | 117.719 | 104.926 | 106.226 | 144.237 | 80.289 | 89.921 | 39.698 | 34.927 |
| 2014 | 125.084 | 97.945 | 83.357 | 80.869 | 105.344 | 56.234 | 60.311 | 25.441 |
| 2015 | 126.164 | 100.745 | 75.708 | 61.993 | 57.867 | 72.435 | 37.081 | 38.037 |
| 2016 | 94.550 | 99.584 | 76.308 | 55.173 | 43.467 | 38.986 | 46.798 | 22.912 |
| 2017 | 85.936 | 74.600 | 74.828 | 54.852 | 38.001 | 28.684 | 24.621 | 28.224 |

Table 14B Continued. Expected biomass-at-age (metric tons) at the beginning of the year (January 1st) for female Scamp in the Gulf of Mexico.

| Year | 16 | 17 | 18 | 19 | 20+ |
|------|--------|--------|-------|-------|-------|
| 1986 | 8.541 | 4.821 | 2.573 | 1.292 | 1.044 |
| 1987 | 8.188 | 4.621 | 2.465 | 1.238 | 1.000 |
| 1988 | 7.906 | 4.461 | 2.380 | 1.195 | 0.965 |
| 1989 | 7.902 | 4.459 | 2.379 | 1.195 | 0.965 |
| 1990 | 7.917 | 4.467 | 2.382 | 1.196 | 0.966 |
| 1991 | 7.792 | 4.389 | 2.338 | 1.173 | 0.946 |
| 1992 | 7.438 | 4.180 | 2.222 | 1.113 | 0.895 |
| 1993 | 7.107 | 3.982 | 2.112 | 1.056 | 0.848 |
| 1994 | 6.537 | 3.649 | 1.930 | 0.962 | 0.770 |
| 1995 | 6.590 | 3.664 | 1.932 | 0.961 | 0.767 |
| 1996 | 6.729 | 3.719 | 1.953 | 0.968 | 0.770 |
| 1997 | 6.983 | 3.822 | 1.995 | 0.985 | 0.780 |
| 1998 | 7.140 | 3.847 | 1.988 | 0.976 | 0.768 |
| 1999 | 7.775 | 4.107 | 2.090 | 1.016 | 0.793 |
| 2000 | 8.639 | 4.538 | 2.266 | 1.086 | 0.838 |
| 2001 | 9.806 | 5.198 | 2.582 | 1.214 | 0.919 |
| 2002 | 5.448 | 5.780 | 2.897 | 1.354 | 0.998 |
| 2003 | 7.798 | 3.199 | 3.208 | 1.514 | 1.098 |
| 2004 | 8.509 | 4.461 | 1.730 | 1.634 | 1.189 |
| 2005 | 15.591 | 4.853 | 2.406 | 0.878 | 1.281 |
| 2006 | 18.507 | 9.146 | 2.691 | 1.256 | 0.988 |
| 2007 | 14.267 | 11.096 | 5.186 | 1.437 | 1.060 |
| 2008 | 18.204 | 8.440 | 6.207 | 2.731 | 1.171 |
| 2009 | 13.122 | 10.567 | 4.633 | 3.208 | 1.827 |
| 2010 | 12.660 | 7.717 | 5.877 | 2.427 | 2.385 |
| 2011 | 14.853 | 7.623 | 4.395 | 3.152 | 2.300 |
| 2012 | 15.975 | 9.092 | 4.413 | 2.396 | 2.653 |
| 2013 | 13.871 | 9.147 | 4.925 | 2.251 | 2.274 |
| 2014 | 21.325 | 8.041 | 5.015 | 2.542 | 2.057 |
| 2015 | 15.298 | 12.182 | 4.346 | 2.553 | 2.075 |
| 2016 | 22.407 | 8.561 | 6.449 | 2.167 | 2.051 |
| 2017 | 13.160 | 12.216 | 4.413 | 3.130 | 1.812 |

Table 15A. Expected numbers-at-age (1,000s of fish) at the beginning of the year (January 1st) for male Scamp in the Gulf of Mexico.

| Year | 0 | 1 | 2 | 3 | 4 | 5 | 6 | 7 | 8 | 9 | 10 | 11 |
|------|---|---|---|---|--------|--------|--------|--------|--------|--------|--------|--------|
| 1986 | 0 | 0 | 0 | 0 | 6.738 | 12.401 | 16.646 | 19.396 | 20.767 | 20.973 | 20.262 | 18.883 |
| 1987 | 0 | 0 | 0 | 0 | 6.688 | 12.124 | 16.120 | 18.703 | 19.990 | 20.171 | 19.474 | 18.136 |
| 1988 | 0 | 0 | 0 | 0 | 6.696 | 12.087 | 15.853 | 18.226 | 19.396 | 19.537 | 18.847 | 17.543 |
| 1989 | 0 | 0 | 0 | 0 | 6.722 | 12.245 | 16.088 | 18.322 | 19.383 | 19.488 | 18.803 | 17.513 |
| 1990 | 0 | 0 | 0 | 0 | 3.439 | 12.479 | 16.593 | 18.907 | 19.758 | 19.687 | 18.911 | 17.583 |
| 1991 | 0 | 0 | 0 | 0 | 4.642 | 6.512 | 17.333 | 19.924 | 20.688 | 20.214 | 19.120 | 17.607 |
| 1992 | 0 | 0 | 0 | 0 | 4.907 | 8.754 | 8.972 | 20.544 | 21.419 | 20.714 | 19.155 | 17.329 |
| 1993 | 0 | 0 | 0 | 0 | 8.787 | 9.195 | 11.941 | 10.507 | 21.828 | 21.230 | 19.469 | 17.249 |
| 1994 | 0 | 0 | 0 | 0 | 9.979 | 16.276 | 12.333 | 13.678 | 10.869 | 20.986 | 19.299 | 16.918 |
| 1995 | 0 | 0 | 0 | 0 | 7.405 | 18.847 | 22.534 | 14.768 | 14.951 | 11.135 | 20.459 | 18.073 |
| 1996 | 0 | 0 | 0 | 0 | 9.340 | 14.072 | 26.298 | 27.215 | 16.282 | 15.444 | 10.940 | 19.302 |
| 1997 | 0 | 0 | 0 | 0 | 6.821 | 17.741 | 19.648 | 31.826 | 30.103 | 16.889 | 15.248 | 10.377 |
| 1998 | 0 | 0 | 0 | 0 | 6.590 | 12.860 | 24.468 | 23.376 | 34.477 | 30.499 | 16.255 | 14.079 |
| 1999 | 0 | 0 | 0 | 0 | 7.627 | 12.506 | 17.979 | 29.735 | 26.030 | 36.070 | 30.410 | 15.585 |
| 2000 | 0 | 0 | 0 | 0 | 7.970 | 14.426 | 17.365 | 21.651 | 32.843 | 27.098 | 35.925 | 29.229 |
| 2001 | 0 | 0 | 0 | 0 | 7.212 | 15.178 | 20.287 | 21.311 | 24.480 | 35.099 | 27.752 | 35.540 |
| 2002 | 0 | 0 | 0 | 0 | 11.295 | 13.696 | 21.229 | 24.674 | 23.803 | 25.779 | 35.354 | 26.968 |
| 2003 | 0 | 0 | 0 | 0 | 8.327 | 21.462 | 19.156 | 25.800 | 27.518 | 25.010 | 25.895 | 34.248 |
| 2004 | 0 | 0 | 0 | 0 | 12.811 | 15.627 | 29.237 | 22.447 | 27.699 | 27.899 | 24.311 | 24.330 |
| 2005 | 0 | 0 | 0 | 0 | 8.224 | 24.027 | 21.262 | 34.202 | 24.052 | 28.021 | 27.054 | 22.783 |
| 2006 | 0 | 0 | 0 | 0 | 11.200 | 15.623 | 33.493 | 25.698 | 37.947 | 25.172 | 28.068 | 26.153 |
| 2007 | 0 | 0 | 0 | 0 | 6.471 | 21.235 | 21.740 | 40.510 | 28.655 | 40.090 | 25.545 | 27.564 |
| 2008 | 0 | 0 | 0 | 0 | 5.205 | 12.248 | 29.434 | 26.127 | 44.796 | 29.978 | 40.243 | 24.796 |
| 2009 | 0 | 0 | 0 | 0 | 4.960 | 9.754 | 16.668 | 34.527 | 28.168 | 45.742 | 29.417 | 38.235 |
| 2010 | 0 | 0 | 0 | 0 | 5.400 | 9.321 | 13.344 | 19.702 | 37.563 | 29.053 | 45.373 | 28.269 |
| 2011 | 0 | 0 | 0 | 0 | 5.750 | 10.181 | 12.853 | 15.978 | 21.794 | 39.489 | 29.419 | 44.556 |
| 2012 | 0 | 0 | 0 | 0 | 4.600 | 10.932 | 14.257 | 15.709 | 18.063 | 23.396 | 40.783 | 29.434 |
| 2013 | 0 | 0 | 0 | 0 | 4.312 | 8.538 | 14.606 | 16.325 | 16.522 | 18.029 | 22.496 | 38.045 |
| 2014 | 0 | 0 | 0 | 0 | 3.648 | 8.076 | 11.602 | 17.095 | 17.556 | 16.830 | 17.653 | 21.330 |
| 2015 | 0 | 0 | 0 | 0 | 3.500 | 6.717 | 10.642 | 13.065 | 17.707 | 17.311 | 16.033 | 16.352 |
| 2016 | 0 | 0 | 0 | 0 | 3.284 | 6.403 | 8.741 | 11.776 | 13.270 | 17.112 | 16.160 | 14.553 |
| 2017 | 0 | 0 | 0 | 0 | 6.425 | 6.071 | 8.465 | 9.822 | 12.061 | 12.818 | 15.847 | 14.468 |

Table 15A Continued. Expected numbers-at-age (1,000s of fish) at the beginning of the year (January 1st) for male Scamp in the Gulf of Mexico.

| Year | 12 | 13 | 14 | 15 | 16 | 17 | 18 | 19 | 20+ |
|------|--------|--------|--------|--------|--------|--------|--------|--------|--------|
| 1986 | 17.062 | 15.000 | 12.863 | 10.782 | 8.850 | 7.127 | 5.645 | 4.407 | 14.057 |
| 1987 | 16.379 | 14.393 | 12.338 | 10.338 | 8.483 | 6.831 | 5.410 | 4.223 | 13.466 |
| 1988 | 15.835 | 13.909 | 11.919 | 9.984 | 8.191 | 6.595 | 5.222 | 4.076 | 12.994 |
| 1989 | 15.817 | 13.898 | 11.912 | 9.979 | 8.187 | 6.592 | 5.219 | 4.074 | 12.989 |
| 1990 | 15.868 | 13.936 | 11.940 | 10.000 | 8.203 | 6.603 | 5.227 | 4.080 | 13.003 |
| 1991 | 15.796 | 13.818 | 11.803 | 9.861 | 8.073 | 6.488 | 5.129 | 3.999 | 12.716 |
| 1992 | 15.371 | 13.349 | 11.346 | 9.443 | 7.707 | 6.179 | 4.875 | 3.795 | 12.024 |
| 1993 | 15.052 | 12.937 | 10.925 | 9.052 | 7.363 | 5.887 | 4.635 | 3.601 | 11.366 |
| 1994 | 14.432 | 12.187 | 10.174 | 8.369 | 6.773 | 5.394 | 4.234 | 3.281 | 10.299 |
| 1995 | 15.311 | 12.675 | 10.419 | 8.488 | 6.828 | 5.416 | 4.238 | 3.277 | 10.232 |
| 1996 | 16.474 | 13.542 | 10.912 | 8.752 | 6.972 | 5.497 | 4.284 | 3.302 | 10.247 |
| 1997 | 17.695 | 14.658 | 11.730 | 9.224 | 7.235 | 5.650 | 4.377 | 3.361 | 10.348 |
| 1998 | 9.251 | 15.298 | 12.328 | 9.623 | 7.398 | 5.686 | 4.362 | 3.328 | 10.145 |
| 1999 | 13.054 | 8.329 | 13.412 | 10.551 | 8.056 | 6.072 | 4.586 | 3.466 | 10.428 |
| 2000 | 14.532 | 11.849 | 7.377 | 11.616 | 8.951 | 6.708 | 4.972 | 3.703 | 10.945 |
| 2001 | 28.070 | 13.591 | 10.817 | 6.586 | 10.160 | 7.685 | 5.665 | 4.140 | 11.904 |
| 2002 | 33.496 | 25.748 | 12.163 | 9.464 | 5.644 | 8.544 | 6.356 | 4.619 | 12.766 |
| 2003 | 25.330 | 30.615 | 22.958 | 10.602 | 8.079 | 4.728 | 7.040 | 5.163 | 13.782 |
| 2004 | 31.251 | 22.516 | 26.568 | 19.485 | 8.816 | 6.594 | 3.796 | 5.573 | 14.643 |
| 2005 | 22.141 | 27.701 | 19.483 | 22.482 | 16.154 | 7.173 | 5.278 | 2.996 | 15.578 |
| 2006 | 21.366 | 20.210 | 24.672 | 16.965 | 19.175 | 13.521 | 5.905 | 4.284 | 14.689 |
| 2007 | 24.965 | 19.879 | 18.366 | 21.935 | 14.781 | 16.402 | 11.378 | 4.901 | 15.353 |
| 2008 | 25.993 | 22.937 | 17.834 | 16.117 | 18.861 | 12.476 | 13.619 | 9.316 | 16.173 |
| 2009 | 22.907 | 23.410 | 20.179 | 15.351 | 13.595 | 15.620 | 10.165 | 10.942 | 20.023 |
| 2010 | 35.742 | 20.884 | 20.854 | 17.592 | 13.117 | 11.407 | 12.895 | 8.276 | 24.673 |
| 2011 | 27.022 | 33.336 | 19.038 | 18.608 | 15.389 | 11.269 | 9.643 | 10.751 | 26.854 |
| 2012 | 43.360 | 25.645 | 30.911 | 17.276 | 16.551 | 13.440 | 9.683 | 8.172 | 31.146 |
| 2013 | 26.738 | 38.443 | 22.227 | 26.228 | 14.371 | 13.522 | 10.805 | 7.678 | 30.432 |
| 2014 | 35.082 | 24.041 | 33.768 | 19.105 | 22.095 | 11.887 | 11.003 | 8.671 | 29.823 |
| 2015 | 19.271 | 30.968 | 20.762 | 28.564 | 15.850 | 18.007 | 9.535 | 8.707 | 29.720 |
| 2016 | 14.475 | 16.668 | 26.202 | 17.206 | 23.216 | 12.655 | 14.150 | 7.391 | 29.063 |
| 2017 | 12.655 | 12.263 | 13.785 | 21.195 | 13.635 | 18.059 | 9.682 | 10.674 | 26.799 |

Table 15B. Expected biomass-at-age (metric tons) at the beginning of the year (January 1st) for male Scamp in the Gulf of Mexico.

| Year | 0 | 1 | 2 | 3 | 4 | 5 | 6 | 7 | 8 | 9 | 10 | 11 |
|------|---|---|---|---|-------|--------|--------|--------|--------|--------|--------|---------|
| 1986 | 0 | 0 | 0 | 0 | 2.626 | 7.733 | 14.864 | 22.977 | 30.881 | 37.554 | 42.307 | 44.823 |
| 1987 | 0 | 0 | 0 | 0 | 2.606 | 7.560 | 14.394 | 22.157 | 29.726 | 36.117 | 40.660 | 43.052 |
| 1988 | 0 | 0 | 0 | 0 | 2.609 | 7.538 | 14.156 | 21.591 | 28.841 | 34.982 | 39.351 | 41.643 |
| 1989 | 0 | 0 | 0 | 0 | 2.619 | 7.636 | 14.366 | 21.705 | 28.822 | 34.894 | 39.259 | 41.573 |
| 1990 | 0 | 0 | 0 | 0 | 1.340 | 7.782 | 14.817 | 22.398 | 29.380 | 35.251 | 39.485 | 41.738 |
| 1991 | 0 | 0 | 0 | 0 | 1.809 | 4.061 | 15.478 | 23.602 | 30.763 | 36.195 | 39.923 | 41.796 |
| 1992 | 0 | 0 | 0 | 0 | 1.912 | 5.459 | 8.011 | 24.337 | 31.850 | 37.090 | 39.995 | 41.136 |
| 1993 | 0 | 0 | 0 | 0 | 3.424 | 5.734 | 10.663 | 12.447 | 32.459 | 38.015 | 40.651 | 40.946 |
| 1994 | 0 | 0 | 0 | 0 | 3.888 | 10.150 | 11.013 | 16.203 | 16.162 | 37.576 | 40.296 | 40.159 |
| 1995 | 0 | 0 | 0 | 0 | 2.885 | 11.753 | 20.122 | 17.495 | 22.232 | 19.939 | 42.718 | 42.901 |
| 1996 | 0 | 0 | 0 | 0 | 3.639 | 8.775 | 23.483 | 32.240 | 24.211 | 27.653 | 22.843 | 45.818 |
| 1997 | 0 | 0 | 0 | 0 | 2.658 | 11.063 | 17.545 | 37.702 | 44.763 | 30.241 | 31.837 | 24.633 |
| 1998 | 0 | 0 | 0 | 0 | 2.568 | 8.019 | 21.849 | 27.692 | 51.267 | 54.611 | 33.941 | 33.420 |
| 1999 | 0 | 0 | 0 | 0 | 2.972 | 7.799 | 16.055 | 35.225 | 38.706 | 64.586 | 63.496 | 36.995 |
| 2000 | 0 | 0 | 0 | 0 | 3.106 | 8.996 | 15.507 | 25.648 | 48.837 | 48.522 | 75.011 | 69.384 |
| 2001 | 0 | 0 | 0 | 0 | 2.810 | 9.465 | 18.116 | 25.245 | 36.402 | 62.847 | 57.945 | 84.365 |
| 2002 | 0 | 0 | 0 | 0 | 4.401 | 8.541 | 18.957 | 29.230 | 35.396 | 46.159 | 73.818 | 64.017 |
| 2003 | 0 | 0 | 0 | 0 | 3.244 | 13.384 | 17.106 | 30.564 | 40.919 | 44.783 | 54.068 | 81.298 |
| 2004 | 0 | 0 | 0 | 0 | 4.992 | 9.745 | 26.108 | 26.591 | 41.189 | 49.955 | 50.760 | 57.754 |
| 2005 | 0 | 0 | 0 | 0 | 3.204 | 14.983 | 18.987 | 40.516 | 35.765 | 50.174 | 56.488 | 54.083 |
| 2006 | 0 | 0 | 0 | 0 | 4.364 | 9.742 | 29.908 | 30.443 | 56.427 | 45.072 | 58.604 | 62.083 |
| 2007 | 0 | 0 | 0 | 0 | 2.521 | 13.242 | 19.413 | 47.990 | 42.611 | 71.783 | 53.336 | 65.432 |
| 2008 | 0 | 0 | 0 | 0 | 2.028 | 7.638 | 26.284 | 30.951 | 66.611 | 53.677 | 84.026 | 58.861 |
| 2009 | 0 | 0 | 0 | 0 | 1.933 | 6.082 | 14.884 | 40.902 | 41.886 | 81.905 | 61.423 | 90.763 |
| 2010 | 0 | 0 | 0 | 0 | 2.104 | 5.812 | 11.916 | 23.339 | 55.856 | 52.022 | 94.738 | 67.105 |
| 2011 | 0 | 0 | 0 | 0 | 2.241 | 6.349 | 11.477 | 18.928 | 32.407 | 70.708 | 61.427 | 105.766 |
| 2012 | 0 | 0 | 0 | 0 | 1.792 | 6.817 | 12.731 | 18.609 | 26.859 | 41.892 | 85.154 | 69.870 |
| 2013 | 0 | 0 | 0 | 0 | 1.680 | 5.324 | 13.043 | 19.339 | 24.568 | 32.283 | 46.971 | 90.311 |
| 2014 | 0 | 0 | 0 | 0 | 1.421 | 5.036 | 10.360 | 20.251 | 26.105 | 30.135 | 36.859 | 50.634 |
| 2015 | 0 | 0 | 0 | 0 | 1.364 | 4.189 | 9.503 | 15.477 | 26.331 | 30.997 | 33.477 | 38.816 |
| 2016 | 0 | 0 | 0 | 0 | 1.280 | 3.993 | 7.805 | 13.950 | 19.733 | 30.639 | 33.742 | 34.545 |
| 2017 | 0 | 0 | 0 | 0 | 2.504 | 3.786 | 7.559 | 11.635 | 17.935 | 22.952 | 33.087 | 34.344 |

Table 15B Continued. Expected biomass-at-age (metric tons) at the beginning of the year (January 1st) for male Scamp in the Gulf of Mexico.

| Year | 12 | 13 | 14 | 15 | 16 | 17 | 18 | 19 | 20+ |
|------|---------|---------|---------|--------|--------|--------|--------|--------|---------|
| 1986 | 45.118 | 43.459 | 40.279 | 36.078 | 31.345 | 26.510 | 21.899 | 17.731 | 62.044 |
| 1987 | 43.311 | 41.700 | 38.634 | 34.593 | 30.048 | 25.408 | 20.986 | 16.990 | 59.434 |
| 1988 | 41.873 | 40.299 | 37.323 | 33.410 | 29.014 | 24.529 | 20.257 | 16.398 | 57.349 |
| 1989 | 41.825 | 40.266 | 37.300 | 33.392 | 29.000 | 24.518 | 20.248 | 16.391 | 57.328 |
| 1990 | 41.960 | 40.378 | 37.389 | 33.462 | 29.054 | 24.558 | 20.278 | 16.413 | 57.390 |
| 1991 | 41.771 | 40.036 | 36.960 | 32.998 | 28.594 | 24.131 | 19.899 | 16.089 | 56.119 |
| 1992 | 40.645 | 38.676 | 35.527 | 31.598 | 27.298 | 22.981 | 18.913 | 15.267 | 53.057 |
| 1993 | 39.801 | 37.483 | 34.209 | 30.291 | 26.081 | 21.896 | 17.981 | 14.488 | 50.149 |
| 1994 | 38.163 | 35.309 | 31.860 | 28.006 | 23.991 | 20.064 | 16.425 | 13.201 | 45.437 |
| 1995 | 40.487 | 36.723 | 32.625 | 28.402 | 24.186 | 20.145 | 16.442 | 13.182 | 45.135 |
| 1996 | 43.562 | 39.234 | 34.168 | 29.284 | 24.695 | 20.447 | 16.621 | 13.285 | 45.193 |
| 1997 | 46.792 | 42.468 | 36.731 | 30.864 | 25.628 | 21.016 | 16.982 | 13.520 | 45.631 |
| 1998 | 24.462 | 44.321 | 38.604 | 32.200 | 26.202 | 21.150 | 16.922 | 13.390 | 44.723 |
| 1999 | 34.519 | 24.130 | 41.998 | 35.304 | 28.534 | 22.583 | 17.792 | 13.944 | 45.955 |
| 2000 | 38.427 | 34.330 | 23.101 | 38.869 | 31.704 | 24.949 | 19.290 | 14.898 | 48.221 |
| 2001 | 74.227 | 39.377 | 33.873 | 22.040 | 35.987 | 28.582 | 21.976 | 16.657 | 52.417 |
| 2002 | 88.574 | 74.598 | 38.087 | 31.670 | 19.992 | 31.780 | 24.658 | 18.583 | 56.176 |
| 2003 | 66.982 | 88.700 | 71.888 | 35.475 | 28.617 | 17.587 | 27.309 | 20.770 | 60.579 |
| 2004 | 82.638 | 65.236 | 83.193 | 65.201 | 31.226 | 24.528 | 14.727 | 22.420 | 64.287 |
| 2005 | 58.548 | 80.256 | 61.008 | 75.229 | 57.216 | 26.681 | 20.476 | 12.052 | 68.323 |
| 2006 | 56.498 | 58.555 | 77.256 | 56.768 | 67.917 | 50.289 | 22.909 | 17.233 | 64.932 |
| 2007 | 66.015 | 57.596 | 57.511 | 73.400 | 52.356 | 61.007 | 44.141 | 19.715 | 67.904 |
| 2008 | 68.734 | 66.456 | 55.846 | 53.931 | 66.806 | 46.405 | 52.833 | 37.478 | 71.464 |
| 2009 | 60.573 | 67.825 | 63.188 | 51.368 | 48.156 | 58.099 | 39.436 | 44.021 | 87.551 |
| 2010 | 94.514 | 60.506 | 65.300 | 58.865 | 46.462 | 42.428 | 50.025 | 33.295 | 107.336 |
| 2011 | 71.454 | 96.582 | 59.614 | 62.267 | 54.508 | 41.914 | 37.409 | 43.252 | 117.290 |
| 2012 | 114.658 | 74.300 | 96.794 | 57.808 | 58.625 | 49.990 | 37.566 | 32.876 | 136.064 |
| 2013 | 70.704 | 111.380 | 69.601 | 87.764 | 50.903 | 50.294 | 41.917 | 30.889 | 133.696 |
| 2014 | 92.768 | 69.654 | 105.741 | 63.928 | 78.260 | 44.212 | 42.687 | 34.883 | 131.594 |
| 2015 | 50.959 | 89.721 | 65.012 | 95.581 | 56.141 | 66.977 | 36.990 | 35.028 | 131.301 |
| 2016 | 38.278 | 48.291 | 82.048 | 57.574 | 82.232 | 47.068 | 54.893 | 29.733 | 128.490 |
| 2017 | 33.465 | 35.530 | 43.167 | 70.923 | 48.297 | 67.168 | 37.561 | 42.943 | 118.760 |

Table 16. Input (with log-scale standard errors, SE) and expected (Exp) landings for the Commercial Vertical Line fleet in biomass (B, million pounds gutted weight) and number (N, 1,000s of fish) for Gulf of Mexico Scamp. The expected mean body weight (gutted pounds per fish) was determined by dividing the expected landings in weights by numbers of fish.

| Year | Input B SE | Input B | Exp B | Exp N | Exp Mean Weight |
|------|------------|---------|-------|--------|-----------------|
| 1986 | 0.05 | 0.184 | 0.185 | 46.725 | 3.9 |
| 1987 | 0.05 | 0.185 | 0.187 | 47.400 | 3.9 |
| 1988 | 0.05 | 0.159 | 0.161 | 40.858 | 3.9 |
| 1989 | 0.05 | 0.164 | 0.166 | 41.891 | 4.0 |
| 1990 | 0.05 | 0.156 | 0.158 | 32.353 | 4.9 |
| 1991 | 0.05 | 0.186 | 0.188 | 38.295 | 4.9 |
| 1992 | 0.05 | 0.226 | 0.229 | 46.403 | 4.9 |
| 1993 | 0.05 | 0.218 | 0.222 | 45.539 | 4.9 |
| 1994 | 0.05 | 0.158 | 0.160 | 34.133 | 4.7 |
| 1995 | 0.05 | 0.175 | 0.177 | 38.961 | 4.5 |
| 1996 | 0.05 | 0.166 | 0.167 | 37.538 | 4.5 |
| 1997 | 0.05 | 0.213 | 0.214 | 47.910 | 4.5 |
| 1998 | 0.05 | 0.136 | 0.136 | 29.956 | 4.5 |
| 1999 | 0.05 | 0.175 | 0.175 | 43.609 | 4.0 |
| 2000 | 0.05 | 0.126 | 0.126 | 30.836 | 4.1 |
| 2001 | 0.05 | 0.156 | 0.156 | 37.509 | 4.2 |
| 2002 | 0.05 | 0.187 | 0.186 | 44.722 | 4.2 |
| 2003 | 0.05 | 0.176 | 0.174 | 39.501 | 4.4 |
| 2004 | 0.05 | 0.167 | 0.165 | 37.892 | 4.4 |
| 2005 | 0.05 | 0.167 | 0.165 | 38.046 | 4.3 |
| 2006 | 0.05 | 0.132 | 0.131 | 30.103 | 4.3 |
| 2007 | 0.05 | 0.155 | 0.153 | 34.793 | 4.4 |
| 2008 | 0.05 | 0.139 | 0.138 | 30.631 | 4.5 |
| 2009 | 0.05 | 0.161 | 0.160 | 34.221 | 4.7 |
| 2010 | 0.01 | 0.091 | 0.091 | 18.750 | 4.9 |
| 2011 | 0.01 | 0.085 | 0.085 | 17.117 | 5.0 |
| 2012 | 0.01 | 0.157 | 0.157 | 30.920 | 5.1 |
| 2013 | 0.01 | 0.142 | 0.142 | 27.519 | 5.1 |
| 2014 | 0.01 | 0.106 | 0.106 | 20.421 | 5.2 |
| 2015 | 0.01 | 0.098 | 0.098 | 18.523 | 5.3 |
| 2016 | 0.01 | 0.143 | 0.143 | 26.938 | 5.3 |
| 2017 | 0.01 | 0.086 | 0.086 | 16.480 | 5.2 |

Table 17. Input (with log-scale standard errors, SE) and expected (Exp) landings for the Commercial Longline fleet in biomass (B, million pounds gutted weight) and number (N, 1,000s of fish) for Gulf of Mexico Scamp. The expected mean body weight (gutted pounds per fish) was determined by dividing the expected landings in weights by numbers of fish.

| Year | Input B SE | Input B | Exp B | Exp N | Exp Mean Weight |
|------|------------|---------|-------|--------|-----------------|
| 1986 | 0.05 | 0.174 | 0.175 | 33.452 | 5.2 |
| 1987 | 0.05 | 0.154 | 0.155 | 29.681 | 5.2 |
| 1988 | 0.05 | 0.110 | 0.111 | 21.302 | 5.2 |
| 1989 | 0.05 | 0.127 | 0.128 | 24.537 | 5.2 |
| 1990 | 0.05 | 0.109 | 0.110 | 18.727 | 5.9 |
| 1991 | 0.05 | 0.129 | 0.131 | 22.255 | 5.9 |
| 1992 | 0.05 | 0.076 | 0.077 | 12.974 | 5.9 |
| 1993 | 0.05 | 0.102 | 0.103 | 17.413 | 5.9 |
| 1994 | 0.05 | 0.057 | 0.058 | 9.891 | 5.8 |
| 1995 | 0.05 | 0.061 | 0.061 | 10.715 | 5.7 |
| 1996 | 0.05 | 0.067 | 0.067 | 12.027 | 5.6 |
| 1997 | 0.05 | 0.080 | 0.080 | 14.499 | 5.5 |
| 1998 | 0.05 | 0.085 | 0.085 | 15.500 | 5.5 |
| 1999 | 0.05 | 0.085 | 0.085 | 16.845 | 5.1 |
| 2000 | 0.05 | 0.074 | 0.074 | 14.254 | 5.2 |
| 2001 | 0.05 | 0.112 | 0.112 | 21.309 | 5.3 |
| 2002 | 0.05 | 0.118 | 0.118 | 22.186 | 5.3 |
| 2003 | 0.05 | 0.137 | 0.136 | 25.143 | 5.4 |
| 2004 | 0.05 | 0.152 | 0.151 | 27.984 | 5.4 |
| 2005 | 0.05 | 0.142 | 0.141 | 26.416 | 5.3 |
| 2006 | 0.05 | 0.086 | 0.086 | 16.128 | 5.3 |
| 2007 | 0.05 | 0.120 | 0.120 | 22.309 | 5.4 |
| 2008 | 0.05 | 0.139 | 0.139 | 25.434 | 5.4 |
| 2009 | 0.05 | 0.090 | 0.090 | 16.058 | 5.6 |
| 2010 | 0.01 | 0.065 | 0.065 | 11.255 | 5.8 |
| 2011 | 0.01 | 0.060 | 0.060 | 10.203 | 5.9 |
| 2012 | 0.01 | 0.093 | 0.093 | 15.418 | 6.0 |
| 2013 | 0.01 | 0.104 | 0.104 | 16.885 | 6.1 |
| 2014 | 0.01 | 0.062 | 0.062 | 10.003 | 6.2 |
| 2015 | 0.01 | 0.081 | 0.081 | 12.865 | 6.3 |
| 2016 | 0.01 | 0.143 | 0.143 | 22.635 | 6.3 |
| 2017 | 0.01 | 0.077 | 0.077 | 12.215 | 6.3 |

Table 18. Input (with log-scale standard errors, SE) and expected (Exp) landings for the Recreational Charter Private fleet in biomass (B, million pounds gutted weight) and number (1,000s of fish) for Gulf of Mexico Scamp. The expected mean body weight (gutted pounds per fish) was determined by dividing the expected landings in weights by numbers of fish.

| Year | Input B SE | Input B | Exp B | Exp N | Exp Mean Weight |
|------|------------|---------|-------|--------|-----------------|
| 1986 | 0.05 | 0.194 | 0.197 | 78.771 | 2.5 |
| 1987 | 0.30 | 0.265 | 0.179 | 72.012 | 2.5 |
| 1988 | 0.30 | 0.138 | 0.145 | 58.487 | 2.5 |
| 1989 | 0.30 | 0.082 | 0.073 | 29.063 | 2.5 |
| 1990 | 0.30 | 0.022 | 0.030 | 7.320 | 4.1 |
| 1991 | 0.30 | 0.046 | 0.036 | 8.709 | 4.2 |
| 1992 | 0.30 | 0.058 | 0.058 | 13.987 | 4.2 |
| 1993 | 0.30 | 0.122 | 0.101 | 25.042 | 4.0 |
| 1994 | 0.30 | 0.050 | 0.040 | 10.332 | 3.8 |
| 1995 | 0.30 | 0.015 | 0.011 | 3.072 | 3.7 |
| 1996 | 0.30 | 0.042 | 0.023 | 6.090 | 3.7 |
| 1997 | 0.30 | 0.099 | 0.053 | 14.108 | 3.8 |
| 1998 | 0.30 | 0.128 | 0.041 | 10.690 | 3.8 |
| 1999 | 0.30 | 0.151 | 0.082 | 21.812 | 3.8 |
| 2000 | 0.30 | 0.042 | 0.050 | 13.002 | 3.8 |
| 2001 | 0.30 | 0.061 | 0.068 | 17.452 | 3.9 |
| 2002 | 0.30 | 0.088 | 0.058 | 15.012 | 3.9 |
| 2003 | 0.30 | 0.150 | 0.202 | 57.677 | 3.5 |
| 2004 | 0.30 | 0.131 | 0.215 | 61.813 | 3.5 |
| 2005 | 0.30 | 0.162 | 0.098 | 28.293 | 3.4 |
| 2006 | 0.30 | 0.308 | 0.141 | 40.707 | 3.5 |
| 2007 | 0.30 | 0.097 | 0.158 | 44.900 | 3.5 |
| 2008 | 0.30 | 0.236 | 0.267 | 73.264 | 3.6 |
| 2009 | 0.30 | 0.192 | 0.219 | 57.589 | 3.8 |
| 2010 | 0.30 | 0.085 | 0.190 | 48.040 | 4.0 |
| 2011 | 0.30 | 0.105 | 0.106 | 26.307 | 4.0 |
| 2012 | 0.30 | 0.221 | 0.295 | 72.104 | 4.1 |
| 2013 | 0.30 | 0.253 | 0.195 | 47.317 | 4.1 |
| 2014 | 0.30 | 0.254 | 0.313 | 74.898 | 4.2 |
| 2015 | 0.30 | 0.329 | 0.316 | 74.808 | 4.2 |
| 2016 | 0.30 | 0.237 | 0.202 | 47.649 | 4.2 |
| 2017 | 0.30 | 0.185 | 0.185 | 44.935 | 4.1 |

Table 19. Input (with log-scale standard errors, SE) and expected (Exp) landings for the Recreational Headboat fleet in biomass (B, million pounds gutted weight) and number (1,000s of fish) for Gulf of Mexico Scamp. The expected mean body weight (gutted pounds per fish) was determined by dividing the expected landings in weights by numbers of fish.

| Year | Input B SE | Input B | Exp B | Exp N | Exp Mean Weight |
|------|------------|---------|-------|-------|-----------------|
| 1986 | 0.01 | 0.017 | 0.017 | 7.152 | 2.4 |
| 1987 | 0.30 | 0.011 | 0.011 | 4.739 | 2.4 |
| 1988 | 0.30 | 0.008 | 0.008 | 3.461 | 2.4 |
| 1989 | 0.30 | 0.023 | 0.024 | 9.829 | 2.4 |
| 1990 | 0.30 | 0.007 | 0.007 | 2.186 | 3.1 |
| 1991 | 0.30 | 0.007 | 0.007 | 2.334 | 3.1 |
| 1992 | 0.30 | 0.004 | 0.004 | 1.338 | 3.0 |
| 1993 | 0.30 | 0.004 | 0.004 | 1.413 | 2.8 |
| 1994 | 0.30 | 0.003 | 0.003 | 1.060 | 2.6 |
| 1995 | 0.30 | 0.004 | 0.004 | 1.351 | 2.6 |
| 1996 | 0.30 | 0.002 | 0.002 | 0.890 | 2.7 |
| 1997 | 0.30 | 0.003 | 0.003 | 0.989 | 2.7 |
| 1998 | 0.30 | 0.005 | 0.005 | 1.707 | 2.8 |
| 1999 | 0.30 | 0.003 | 0.003 | 0.845 | 3.1 |
| 2000 | 0.30 | 0.004 | 0.004 | 1.275 | 3.1 |
| 2001 | 0.30 | 0.002 | 0.002 | 0.492 | 3.2 |
| 2002 | 0.30 | 0.002 | 0.002 | 0.520 | 3.1 |
| 2003 | 0.30 | 0.002 | 0.002 | 0.641 | 3.4 |
| 2004 | 0.30 | 0.003 | 0.003 | 1.023 | 3.4 |
| 2005 | 0.30 | 0.002 | 0.002 | 0.654 | 3.3 |
| 2006 | 0.30 | 0.002 | 0.002 | 0.650 | 3.4 |
| 2007 | 0.30 | 0.002 | 0.002 | 0.721 | 3.4 |
| 2008 | 0.30 | 0.002 | 0.004 | 1.046 | 3.5 |
| 2009 | 0.30 | 0.001 | 0.003 | 0.772 | 3.7 |
| 2010 | 0.30 | 0.004 | 0.005 | 1.299 | 3.9 |
| 2011 | 0.30 | 0.004 | 0.006 | 1.420 | 3.9 |
| 2012 | 0.30 | 0.003 | 0.005 | 1.246 | 4.0 |
| 2013 | 0.30 | 0.004 | 0.006 | 1.428 | 4.0 |
| 2014 | 0.30 | 0.007 | 0.009 | 2.204 | 4.1 |
| 2015 | 0.30 | 0.009 | 0.011 | 2.752 | 4.1 |
| 2016 | 0.30 | 0.005 | 0.006 | 1.543 | 4.1 |
| 2017 | 0.30 | 0.004 | 0.005 | 1.147 | 4.0 |

Table 20. Input (with log-scale standard errors, SE) and expected (Exp) discards for the Commercial Vertical Line fleet in number (N, 1,000s of fish) and biomass (B, thousand pounds gutted weight) for Gulf of Mexico Scamp. Dead discards in numbers (discard mortality rate = 0.47), biomass, and mean weight (MW, gutted pounds per fish) are included.

| Year | Input N SE | Input N | Exp N | Exp Dead N | Exp B | Exp Dead B | Exp MW |
|------|------------|---------|--------|------------|---------|------------|--------|
| 1986 | | | 0.002 | 0.001 | 0.008 | 0.004 | 4.0 |
| 1987 | | | 0.002 | 0.001 | 0.008 | 0.004 | 3.8 |
| 1988 | | | 0.002 | 0.001 | 0.007 | 0.004 | 3.8 |
| 1989 | | | 0.002 | 0.001 | 0.008 | 0.004 | 4.1 |
| 1990 | | | 28.236 | 13.271 | 85.098 | 39.996 | 3.0 |
| 1991 | | | 32.830 | 15.430 | 99.881 | 46.944 | 3.0 |
| 1992 | | | 40.551 | 19.059 | 120.639 | 56.701 | 3.0 |
| 1993 | | | 42.676 | 20.058 | 120.136 | 56.465 | 2.8 |
| 1994 | | | 34.390 | 16.163 | 92.639 | 43.541 | 2.7 |
| 1995 | | | 40.215 | 18.901 | 107.889 | 50.708 | 2.7 |
| 1996 | | | 38.271 | 17.987 | 104.608 | 49.166 | 2.7 |
| 1997 | | | 47.247 | 22.206 | 132.842 | 62.435 | 2.8 |
| 1998 | | | 28.395 | 13.346 | 82.005 | 38.542 | 2.9 |
| 1999 | | | 3.830 | 1.800 | 6.332 | 2.976 | 1.7 |
| 2000 | 0.390 | 2.946 | 2.710 | 1.274 | 4.418 | 2.077 | 1.6 |
| 2001 | 0.390 | 3.470 | 3.385 | 1.591 | 5.405 | 2.540 | 1.6 |
| 2002 | 0.390 | 3.842 | 4.173 | 1.961 | 6.599 | 3.101 | 1.6 |
| 2003 | 0.390 | 4.236 | 7.290 | 3.426 | 9.484 | 4.458 | 1.3 |
| 2004 | 0.390 | 4.083 | 7.112 | 3.342 | 9.391 | 4.414 | 1.3 |
| 2005 | 0.390 | 3.611 | 6.740 | 3.168 | 9.039 | 4.248 | 1.3 |
| 2006 | 0.390 | 3.231 | 4.827 | 2.269 | 6.638 | 3.120 | 1.4 |
| 2007 | 0.390 | 3.080 | 4.666 | 2.193 | 6.583 | 3.094 | 1.4 |
| 2008 | 0.405 | 2.748 | 3.440 | 1.617 | 4.848 | 2.279 | 1.4 |
| 2009 | 0.412 | 3.356 | 3.544 | 1.666 | 4.880 | 2.293 | 1.4 |
| 2010 | 0.421 | 2.421 | 2.274 | 1.069 | 4.106 | 1.930 | 1.8 |
| 2011 | 0.421 | 2.736 | 2.119 | 0.996 | 3.858 | 1.813 | 1.8 |
| 2012 | 0.421 | 3.423 | 3.774 | 1.774 | 6.980 | 3.281 | 1.8 |
| 2013 | 0.421 | 2.822 | 3.305 | 1.553 | 6.177 | 2.903 | 1.9 |
| 2014 | 0.421 | 2.657 | 2.420 | 1.137 | 4.538 | 2.133 | 1.9 |
| 2015 | 0.421 | 2.302 | 2.290 | 1.076 | 4.176 | 1.963 | 1.8 |
| 2016 | 0.421 | 2.790 | 3.991 | 1.876 | 6.685 | 3.142 | 1.7 |
| 2017 | 0.421 | 2.112 | 3.208 | 1.508 | 4.992 | 2.346 | 1.6 |

Table 21. Input (with log-scale standard errors, SE) and expected (Exp) discards for the Commercial Longline fleet in number (N, 1,000s of fish) and biomass (B, thousand pounds gutted weight) for Gulf of Mexico Scamp. Dead discards in numbers (discard mortality rate = 0.47), biomass, and mean weight (MW, gutted pounds per fish) are included.

| Year | Input N SE | Input N | Exp N | Exp Dead N | Exp B | Exp Dead B | Exp MW |
|------|------------|---------|--------|------------|--------|------------|--------|
| 1986 | | | 0.002 | 0.001 | 0.008 | 0.006 | 5.0 |
| 1987 | | | 0.001 | 0.001 | 0.007 | 0.005 | 5.0 |
| 1988 | | | 0.001 | 0.001 | 0.005 | 0.004 | 5.1 |
| 1989 | | | 0.001 | 0.001 | 0.006 | 0.004 | 5.4 |
| 1990 | | | 10.820 | 7.358 | 44.116 | 29.999 | 4.1 |
| 1991 | | | 12.719 | 8.649 | 52.316 | 35.575 | 4.1 |
| 1992 | | | 7.381 | 5.019 | 30.363 | 20.647 | 4.1 |
| 1993 | | | 10.134 | 6.891 | 40.786 | 27.734 | 4.0 |
| 1994 | | | 6.051 | 4.115 | 23.460 | 15.953 | 3.9 |
| 1995 | | | 6.849 | 4.657 | 25.883 | 17.601 | 3.8 |
| 1996 | | | 7.828 | 5.323 | 29.469 | 20.039 | 3.8 |
| 1997 | | | 9.370 | 6.371 | 35.697 | 24.274 | 3.8 |
| 1998 | | | 9.775 | 6.647 | 38.002 | 25.842 | 3.9 |
| 1999 | | | 0.417 | 0.284 | 0.455 | 0.310 | 1.1 |
| 2000 | 0.497 | 0.462 | 0.351 | 0.239 | 0.380 | 0.259 | 1.1 |
| 2001 | 0.497 | 0.564 | 0.549 | 0.373 | 0.586 | 0.399 | 1.1 |
| 2002 | 0.497 | 0.533 | 0.608 | 0.413 | 0.656 | 0.446 | 1.1 |
| 2003 | 0.497 | 0.643 | 1.206 | 0.820 | 1.612 | 1.096 | 1.3 |
| 2004 | 0.497 | 0.688 | 1.383 | 0.940 | 1.874 | 1.274 | 1.4 |
| 2005 | 0.497 | 0.692 | 1.246 | 0.847 | 1.717 | 1.167 | 1.4 |
| 2006 | 0.497 | 0.510 | 0.688 | 0.468 | 0.971 | 0.660 | 1.4 |
| 2007 | 0.497 | 0.537 | 0.789 | 0.537 | 1.144 | 0.778 | 1.4 |
| 2008 | 0.497 | 0.667 | 0.733 | 0.498 | 1.063 | 0.723 | 1.5 |
| 2009 | 0.497 | 0.430 | 0.409 | 0.278 | 0.581 | 0.395 | 1.4 |
| 2010 | 0.333 | 0.251 | 0.388 | 0.264 | 0.774 | 0.526 | 2.0 |
| 2011 | 0.333 | 0.403 | 0.348 | 0.237 | 0.697 | 0.474 | 2.0 |
| 2012 | 0.333 | 0.379 | 0.519 | 0.353 | 1.050 | 0.714 | 2.0 |
| 2013 | 0.333 | 0.458 | 0.561 | 0.381 | 1.144 | 0.778 | 2.0 |
| 2014 | 0.333 | 0.524 | 0.327 | 0.222 | 0.668 | 0.454 | 2.0 |
| 2015 | 0.333 | 0.618 | 0.430 | 0.293 | 0.859 | 0.584 | 2.0 |
| 2016 | 0.333 | 0.664 | 0.872 | 0.593 | 1.618 | 1.101 | 1.9 |
| 2017 | 0.333 | 0.644 | 0.605 | 0.412 | 1.045 | 0.711 | 1.7 |

Table 22. Input (with log-scale standard errors, SE) and expected (Exp) discards for the Recreational Charter Private fleet in number (N, 1,000s of fish) and biomass (B, thousand pounds gutted weight) for Gulf of Mexico Scamp. Dead discards in numbers (discard mortality rate = 0.47), biomass, and mean weight (MW, gutted pounds per fish) are included.

| Year | Input N SE | Input N | Exp N | Exp Dead N | Exp B | Exp Dead B | Exp MW |
|------|------------|---------|--------|------------|---------|------------|--------|
| 1986 | 0.609 | 54.118 | 14.865 | 3.865 | 10.847 | 2.820 | 0.7 |
| 1987 | 0.646 | 1.428 | 13.815 | 3.592 | 10.093 | 2.624 | 0.7 |
| 1988 | 0.783 | 3.701 | 10.989 | 2.857 | 8.072 | 2.099 | 0.7 |
| 1989 | 0.617 | 1.858 | 4.235 | 1.101 | 3.083 | 0.801 | 0.7 |
| 1990 | 0.601 | 40.696 | 18.396 | 4.783 | 30.966 | 8.051 | 1.7 |
| 1991 | 0.833 | 3.128 | 21.831 | 5.676 | 36.085 | 9.382 | 1.7 |
| 1992 | 0.506 | 31.849 | 40.916 | 10.638 | 62.047 | 16.132 | 1.5 |
| 1993 | 0.489 | 40.068 | 88.676 | 23.056 | 126.617 | 32.920 | 1.4 |
| 1994 | 0.639 | 12.792 | 38.099 | 9.906 | 55.691 | 14.480 | 1.5 |
| 1995 | 0.578 | 4.780 | 10.938 | 2.844 | 16.468 | 4.282 | 1.5 |
| 1996 | 0.757 | 0.930 | 20.026 | 5.207 | 31.341 | 8.149 | 1.6 |
| 1997 | 0.578 | 7.025 | 42.147 | 10.958 | 68.319 | 17.763 | 1.6 |
| 1998 | 0.481 | 4.545 | 30.410 | 7.907 | 49.405 | 12.845 | 1.6 |
| 1999 | 0.530 | 9.645 | 39.064 | 10.157 | 53.075 | 13.800 | 1.4 |
| 2000 | 0.751 | 63.768 | 23.227 | 6.039 | 31.478 | 8.184 | 1.4 |
| 2001 | 0.661 | 54.874 | 33.215 | 8.636 | 43.793 | 11.386 | 1.3 |
| 2002 | 0.349 | 19.904 | 29.561 | 7.686 | 39.173 | 10.185 | 1.3 |
| 2003 | 0.403 | 170.019 | 85.411 | 22.207 | 104.594 | 27.194 | 1.2 |
| 2004 | 0.322 | 176.484 | 89.572 | 23.289 | 112.114 | 29.150 | 1.3 |
| 2005 | 0.322 | 26.932 | 38.390 | 9.982 | 48.256 | 12.546 | 1.3 |
| 2006 | 0.455 | 19.127 | 49.218 | 12.797 | 64.146 | 16.678 | 1.3 |
| 2007 | 0.322 | 89.096 | 44.240 | 11.502 | 60.419 | 15.709 | 1.4 |
| 2008 | 0.358 | 114.679 | 62.649 | 16.289 | 87.695 | 22.800 | 1.4 |
| 2009 | 0.472 | 143.342 | 49.240 | 12.802 | 68.576 | 17.830 | 1.4 |
| 2010 | 0.385 | 232.070 | 44.597 | 11.595 | 61.215 | 15.916 | 1.4 |
| 2011 | 0.438 | 31.442 | 25.087 | 6.523 | 34.796 | 9.047 | 1.4 |
| 2012 | 0.617 | 184.383 | 66.816 | 17.372 | 93.884 | 24.410 | 1.4 |
| 2013 | 0.498 | 28.365 | 42.906 | 11.156 | 60.652 | 15.770 | 1.4 |
| 2014 | 0.312 | 125.895 | 67.299 | 17.498 | 95.094 | 24.725 | 1.4 |
| 2015 | 0.498 | 184.662 | 70.415 | 18.308 | 97.744 | 25.413 | 1.4 |
| 2016 | 0.349 | 59.087 | 59.017 | 15.345 | 74.782 | 19.444 | 1.3 |
| 2017 | 0.609 | 77.092 | 74.560 | 19.386 | 90.455 | 23.518 | 1.2 |

Table 23. Input (with log-scale standard errors, SE) and expected (Exp) discards for the Recreational Headboat fleet in number (N, 1,000s of fish) and biomass (B, thousand pounds gutted weight) for Gulf of Mexico Scamp. Dead discards in numbers (discard mortality rate = 0.47), biomass, and mean weight (MW, gutted pounds per fish) are included.

| Year | Input N SE | Input N | Exp N | Exp Dead N | Exp B | Exp Dead B | Exp MW |
|------|------------|---------|-------|------------|-------|------------|--------|
| 1986 | | | 0.000 | 0.000 | 0.001 | 0.000 | 2.3 |
| 1987 | | | 0.000 | 0.000 | 0.001 | 0.000 | 2.1 |
| 1988 | | | 0.000 | 0.000 | 0.000 | 0.000 | 2.2 |
| 1989 | | | 0.001 | 0.000 | 0.001 | 0.000 | 2.2 |
| 1990 | | | 3.002 | 0.781 | 6.369 | 1.656 | 2.1 |
| 1991 | | | 3.213 | 0.835 | 6.784 | 1.764 | 2.1 |
| 1992 | | | 1.937 | 0.504 | 3.843 | 0.999 | 2.0 |
| 1993 | | | 2.167 | 0.563 | 4.012 | 1.043 | 1.9 |
| 1994 | | | 1.645 | 0.428 | 3.014 | 0.784 | 1.8 |
| 1995 | | | 2.069 | 0.538 | 3.865 | 1.005 | 1.9 |
| 1996 | | | 1.333 | 0.347 | 2.563 | 0.666 | 1.9 |
| 1997 | | | 1.442 | 0.375 | 2.867 | 0.745 | 2.0 |
| 1998 | | | 2.450 | 0.637 | 4.953 | 1.288 | 2.0 |
| 1999 | | | 1.318 | 0.343 | 2.554 | 0.664 | 1.9 |
| 2000 | 0.472 | 1.811 | 2.006 | 0.522 | 3.905 | 1.015 | 1.9 |
| 2001 | 0.472 | 0.676 | 0.801 | 0.208 | 1.539 | 0.400 | 1.9 |
| 2002 | 0.472 | 0.768 | 0.869 | 0.226 | 1.652 | 0.430 | 1.9 |
| 2003 | 0.472 | 1.040 | 0.678 | 0.176 | 0.911 | 0.237 | 1.3 |
| 2004 | 0.472 | 1.610 | 1.087 | 0.283 | 1.480 | 0.385 | 1.4 |
| 2005 | 0.472 | 0.685 | 0.646 | 0.168 | 0.888 | 0.231 | 1.4 |
| 2006 | 0.472 | 0.469 | 0.589 | 0.153 | 0.834 | 0.217 | 1.4 |
| 2007 | 0.472 | 0.671 | 0.550 | 0.143 | 0.809 | 0.210 | 1.5 |
| 2008 | 0.472 | 2.799 | 0.695 | 0.181 | 1.047 | 0.272 | 1.5 |
| 2009 | 0.472 | 2.682 | 0.506 | 0.131 | 0.761 | 0.198 | 1.5 |
| 2010 | 0.472 | 1.760 | 0.908 | 0.236 | 1.356 | 0.353 | 1.5 |
| 2011 | 0.472 | 1.936 | 1.029 | 0.267 | 1.547 | 0.402 | 1.5 |
| 2012 | 0.472 | 1.909 | 0.880 | 0.229 | 1.341 | 0.349 | 1.5 |
| 2013 | 0.472 | 1.895 | 0.989 | 0.257 | 1.514 | 0.394 | 1.5 |
| 2014 | 0.472 | 2.970 | 1.508 | 0.392 | 2.311 | 0.601 | 1.5 |
| 2015 | 0.472 | 3.500 | 1.972 | 0.513 | 2.957 | 0.769 | 1.5 |
| 2016 | 0.472 | 1.880 | 1.363 | 0.355 | 1.897 | 0.493 | 1.4 |
| 2017 | 0.472 | 1.689 | 1.338 | 0.348 | 1.782 | 0.463 | 1.3 |

Table 24. Input (with log-scale standard errors, SE) versus expected (Exp) standardized fishery-dependent catch-per-unit-effort (CPUE) indices for Gulf of Mexico Scamp. SEs shown below include an extra variance adjustment added to the original SEs (**Table 9**).

| Year | ComVL (Input) | ComVL (Exp) | ComVL (SE) | Headboat (Input) | Headboat (Exp) | Headboat (SE) |
|------|------------------|----------------|------------|---------------------|-------------------|------------------|
| 1986 | | | | 2.015 | 1.717 | 0.275 |
| 1987 | | | | 1.384 | 1.681 | 0.280 |
| 1988 | | | | 1.477 | 1.665 | 0.267 |
| 1989 | | | | 0.817 | 1.614 | 0.273 |
| 1990 | | | | 1.172 | 0.637 | 0.270 |
| 1991 | | | | 0.979 | 0.601 | 0.276 |
| 1992 | | | | 0.708 | 0.599 | 0.270 |
| 1993 | 0.986 | 0.532 | 0.450 | 0.745 | 0.647 | 0.270 |
| 1994 | 0.849 | 0.525 | 0.449 | 0.863 | 0.727 | 0.270 |
| 1995 | 1.254 | 0.553 | 0.449 | 1.208 | 0.800 | 0.273 |
| 1996 | 1.048 | 0.596 | 0.449 | 0.846 | 0.846 | 0.280 |
| 1997 | 1.314 | 0.637 | 0.448 | 0.764 | 0.850 | 0.298 |
| 1998 | 0.991 | 0.676 | 0.448 | 0.967 | 0.841 | 0.290 |
| 1999 | 0.954 | 1.099 | 0.448 | 0.679 | 0.803 | 0.310 |
| 2000 | 0.634 | 1.155 | 0.449 | 0.806 | 0.818 | 0.290 |
| 2001 | 1.005 | 1.211 | 0.448 | 0.667 | 0.841 | 0.301 |
| 2002 | 0.991 | 1.259 | 0.448 | 1.005 | 0.883 | 0.284 |
| 2003 | 0.948 | 1.272 | 0.448 | 0.791 | 1.213 | 0.302 |
| 2004 | 1.081 | 1.292 | 0.449 | 1.329 | 1.255 | 0.279 |
| 2005 | 1.302 | 1.341 | 0.449 | 1.287 | 1.331 | 0.280 |
| 2006 | 0.847 | 1.417 | 0.449 | 0.943 | 1.383 | 0.305 |
| 2007 | 1.001 | 1.483 | 0.449 | 1.546 | 1.403 | 0.306 |
| 2008 | 0.966 | 1.496 | 0.449 | 1.440 | 1.319 | 0.288 |
| 2009 | 0.829 | 1.462 | 0.449 | 0.912 | 1.177 | 0.284 |
| 2010 | | | | 0.708 | 1.064 | 0.321 |
| 2011 | | | | 1.757 | 1.007 | 0.294 |
| 2012 | | | | 1.066 | 0.950 | 0.273 |

Table 24 Continued. Input (with log-scale standard errors, SE) versus expected (Exp) standardized fishery-dependent catch-per-unit-effort (CPUE) indices for Gulf of Mexico Scamp. SEs shown below include an extra variance adjustment added to the original SEs (**Table 9**).

| Year | ComVL (Input) | ComVL (Exp) | ComVL (SE) | Headboat (Input) | Headboat (Exp) | Headboat (SE) |
|------|---------------|-------------|------------|------------------|----------------|---------------|
| 2013 | | | | 0.676 | 0.870 | 0.308 |
| 2014 | | | | 0.733 | 0.786 | 0.285 |
| 2015 | | | | 0.785 | 0.691 | 0.285 |
| 2016 | | | | 0.461 | 0.607 | 0.281 |
| 2017 | | | | 0.460 | 0.572 | 0.303 |

Table 25. Input (with log-scale standard errors, SE) versus expected (Exp) standardized fishery-independent indices for Gulf of Mexico Scamp. SEs shown below include an extra variance adjustment added to the original SEs (**Table 9**).

| Year | Combined Video (Input) | Combined Video (Exp) | Combined Video (SE) | RFOP VL (Input) | RFOP VL (Exp) | RFOP VL (SE) |
|------|------------------------|----------------------|---------------------|-----------------|---------------|--------------|
| 1993 | 0.870 | 0.912 | 0.328 | | | |
| 1994 | 0.497 | 0.979 | 0.388 | | | |
| 1995 | 0.565 | 1.042 | 0.407 | | | |
| 1996 | 0.778 | 1.070 | 0.330 | | | |
| 1997 | 0.645 | 1.066 | 0.290 | | | |
| 2002 | 1.758 | 1.274 | 0.297 | | | |
| 2004 | 1.990 | 1.361 | 0.330 | | | |
| 2005 | 1.499 | 1.375 | 0.289 | | | |
| 2006 | 0.941 | 1.345 | 0.324 | | | |
| 2007 | 1.532 | 1.260 | 0.277 | 0.923 | 1.442 | 0.341 |
| 2008 | 1.131 | 1.153 | 0.303 | 0.998 | 1.368 | 0.414 |
| 2009 | 1.228 | 1.063 | 0.283 | 0.979 | 1.262 | 0.423 |
| 2010 | 1.071 | 1.006 | 0.280 | 0.682 | 1.179 | 0.436 |
| 2011 | 1.182 | 0.961 | 0.253 | 0.602 | 1.129 | 0.368 |
| 2012 | 0.673 | 0.891 | 0.275 | 1.206 | 1.057 | 0.297 |
| 2013 | 0.729 | 0.808 | 0.274 | 1.072 | 0.964 | 0.455 |

Table 25 Continued. Input (with log-scale standard errors, SE) versus expected (Exp) standardized fishery-independent indices for Gulf of Mexico Scamp. SEs shown below include an extra variance adjustment added to the original SEs (**Table 9**).

| Year | Combined Video (Input) | Combined Video (Exp) | Combined Video (SE) | RFOP VL (Input) | RFOP VL (Exp) | RFOP VL (SE) |
|------|------------------------|----------------------|---------------------|-----------------|---------------|--------------|
| 2014 | 0.876 | 0.732 | 0.273 | 0.864 | 0.872 | 0.332 |
| 2015 | 0.938 | 0.673 | 0.287 | 1.142 | 0.774 | 0.312 |
| 2016 | 0.790 | 0.670 | 0.258 | 1.251 | 0.695 | 0.336 |
| 2017 | 0.751 | 0.710 | 0.271 | 1.066 | 0.672 | 0.363 |

Table 26. Summary of correlated parameter combinations with correlation coefficients exceeding 0.7 for the Gulf of Mexico Scamp SEDAR 68 AP Base Model.

| Parameter 1 | Parameter 2 | Correlation |
|---|--|-------------|
| Main_RecrDev_2000 | Main_RecrDev_1999 | -0.722 |
| Main_RecrDev_2001 | Main_RecrDev_2000 | -0.772 |
| Main_RecrDev_2002 | Main_RecrDev_2001 | -0.765 |
| Main_RecrDev_2003 | Main_RecrDev_2002 | -0.701 |
| Retain_L_width_Charter_Private(3)_BLK2repl_1999 | Retain_L_infl_Charter_Private(3)_BLK2repl_1999 | 0.739 |
| Retain_L_width_ComVL(1)_BLK1repl_1999 | Retain_L_infl_ComVL(1)_BLK1repl_1999 | -0.895 |
| Size_DblN_ascend_se_Charter_Private(3) | Size_DblN_peak_Charter_Private(3) | 0.937 |
| Size_DblN_ascend_se_Headboat(4) | Size_DblN_peak_Headboat(4) | 0.941 |
| Size_DblN_descend_se_Headboat(4) | Size_DblN_top_logit_Headboat(4) | -1.000 |

Table 27. Summary of sensitivity runs conducted for the Gulf of Mexico Scamp SEDAR 68 AP Base Model. Gray shading groups similar runs together and NLL = negative log-likelihood.

| Description | NLL | Gradient | Estimated Parameters (Bounded) | Parameters with CV>1 |
|--|----------|----------|--------------------------------|----------------------|
| SEDAR 68 AP Base | 16,650.5 | 0.0022 | 220 (1) | 14 |
| Remove Headboat index | 16,670.2 | 0.0894 | | 12 |
| Remove pre-IFQ Commercial Vertical Line index | 16,654.6 | 0.0544 | 220 (1) | 14 |
| Remove Video index | 16,665.5 | 0.0484 | 220 (1) | 13 |
| Remove RFOP index | 16,654.5 | 0.0187 | 220 (1) | 13 |
| Remove all FD indices | 16,679.0 | 0.0350 | 220 (0) | 13 |
| Errors converted from CVs (for numbers) | 16,649.1 | 0.0165 | 220 (1) | 12 |
| Errors scaled to a mean of 0.30 | 16,660.0 | 0.0028 | 220 (1) | 15 |
| Estimate steepness without a prior | 16,648.0 | 0.1799 | 220 (2) | 14 |
| Estimate L_{∞} and K from symmetric beta prior with SD = 0.8 | 16,169.5 | 0.0095 | 222 (0) | 12 |
| Estimate all growth parameters (symmetric beta prior (0.8 SD) on L_{∞} and K) | 16,164.2 | 0.2460 | 224 (0) | 13 |
| High M (0.164 per year, maximum age = 32 years) | 16,652.1 | 0.0724 | 220 (1) | 14 |
| Low M (0.147 per year, maximum age = 36 years) | 16,649.2 | 0.0623 | 220 (1) | 14 |
| Male SSB contribution of 0% (i.e., female only) | 16,649.5 | 0.0011 | 220 (1) | 13 |
| Male SSB contribution of 25% | 16,649.9 | 0.0194 | 220 (1) | 13 |
| Male SSB contribution of 50% | 16,650.2 | 0.6651 | 220 (1) | 14 |
| Male SSB contribution of 75% | 16,650.3 | 0.1066 | 220 (1) | 14 |

Table 27 Continued. Summary of sensitivity runs conducted for the Gulf of Mexico Scamp SEDAR 68 AP Base Model. Gray shading groups similar runs together, mt = metric tons, and Recr = recruitment.

| Description | Steepness | SigmaR | Ln(R0) | Virgin SSB (mt) | Virgin Recr (1,000s) |
|---|-----------|--------|--------|-----------------|----------------------|
| SEDAR 68 AP Base | 0.949 | 0.356 | 7.433 | 3,910.65 | 1,691.01 |
| Remove Headboat index | 0.955 | 0.334 | 7.489 | 4,129.50 | 1,788.29 |
| Remove pre-IFQ Commercial Vertical Line index | 0.952 | 0.353 | 7.434 | 3,911.88 | 1,691.82 |
| Remove Video index | 0.942 | 0.369 | 7.427 | 3,889.03 | 1,681.06 |
| Remove RFOP index | 0.944 | 0.367 | 7.429 | 3,893.86 | 1,683.56 |
| Remove all FD indices | 0.955 | 0.343 | 7.478 | 4,086.00 | 1,769.24 |
| Errors converted from CVs (for numbers) | 0.954 | 0.352 | 7.403 | 3,793.90 | 1,640.62 |
| Errors scaled to a mean of 0.30 | 0.952 | 0.350 | 7.414 | 3,836.27 | 1,659.04 |
| Estimate steepness without a prior | 0.990 | 0.355 | 7.432 | 3,905.21 | 1,688.72 |
| Estimate L_{∞} and K from symmetric beta prior with SD = 0.8 | 0.937 | 0.367 | 7.381 | 3,858.78 | 1,605.66 |
| Estimate all growth parameters (symmetric beta prior (0.8 SD) on L_{∞} and K) | 0.938 | 0.368 | 7.381 | 3,866.63 | 1,605.18 |
| High M (0.164 per year, maximum age = 32 years) | 0.945 | 0.362 | 7.592 | 3,885.00 | 1,982.04 |
| Low M (0.147 per year, maximum age = 36 years) | 0.952 | 0.351 | 7.293 | 3,960.70 | 1,470.19 |
| Male SSB contribution of 0% (i.e., female only) | 0.898 | 0.355 | 7.432 | 1,837.76 | 1,689.97 |
| Male SSB contribution of 25% | 0.924 | 0.356 | 7.433 | 2,356.02 | 1,690.43 |
| Male SSB contribution of 50% | 0.936 | 0.356 | 7.433 | 2,874.23 | 1,690.69 |
| Male SSB contribution of 75% | 0.944 | 0.356 | 7.433 | 3,392.44 | 1,690.87 |

10. Figures

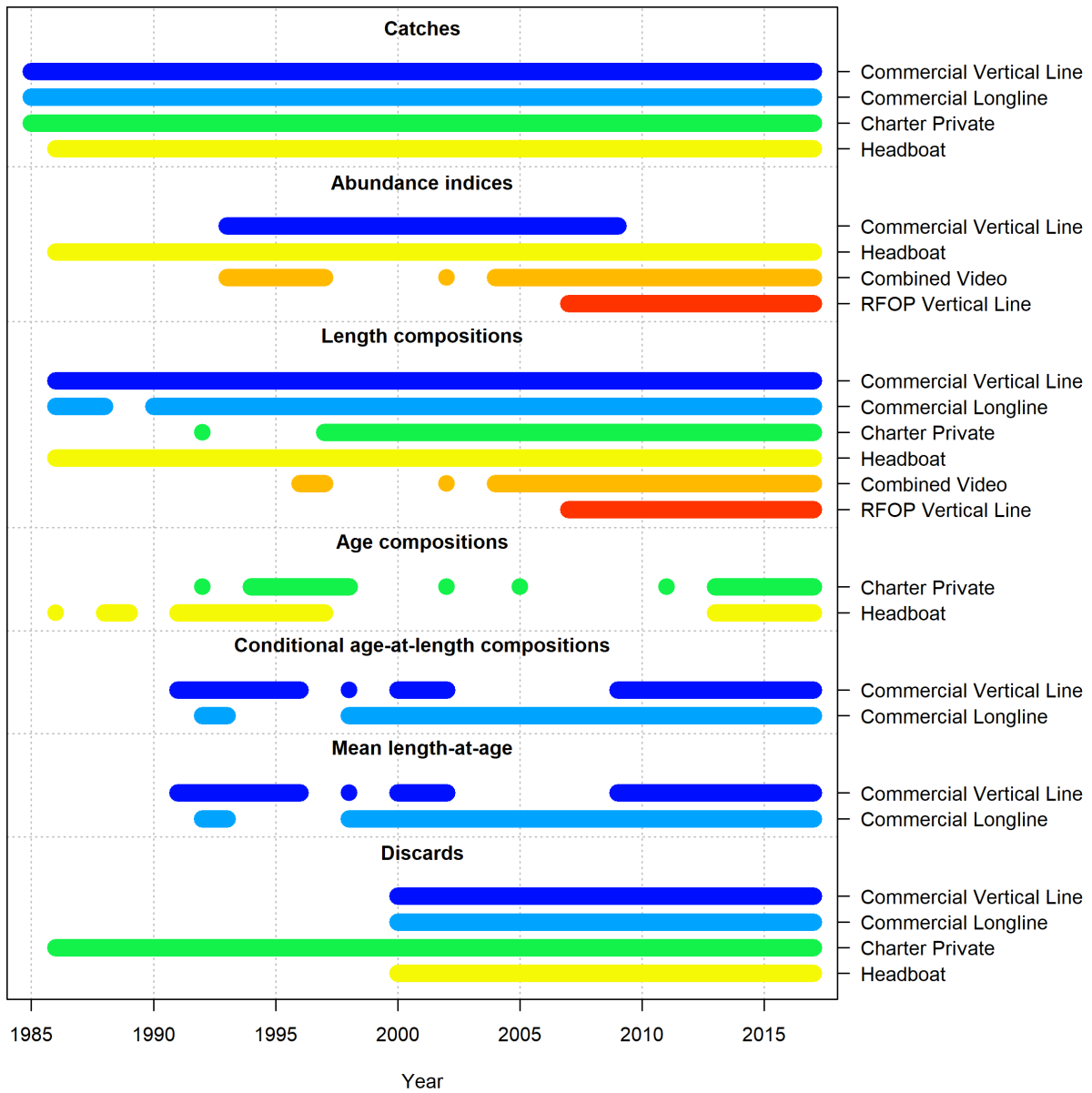

Figure 1. Data sources used in the SEDAR 68 AP Base Model for Gulf of Mexico Scamp.

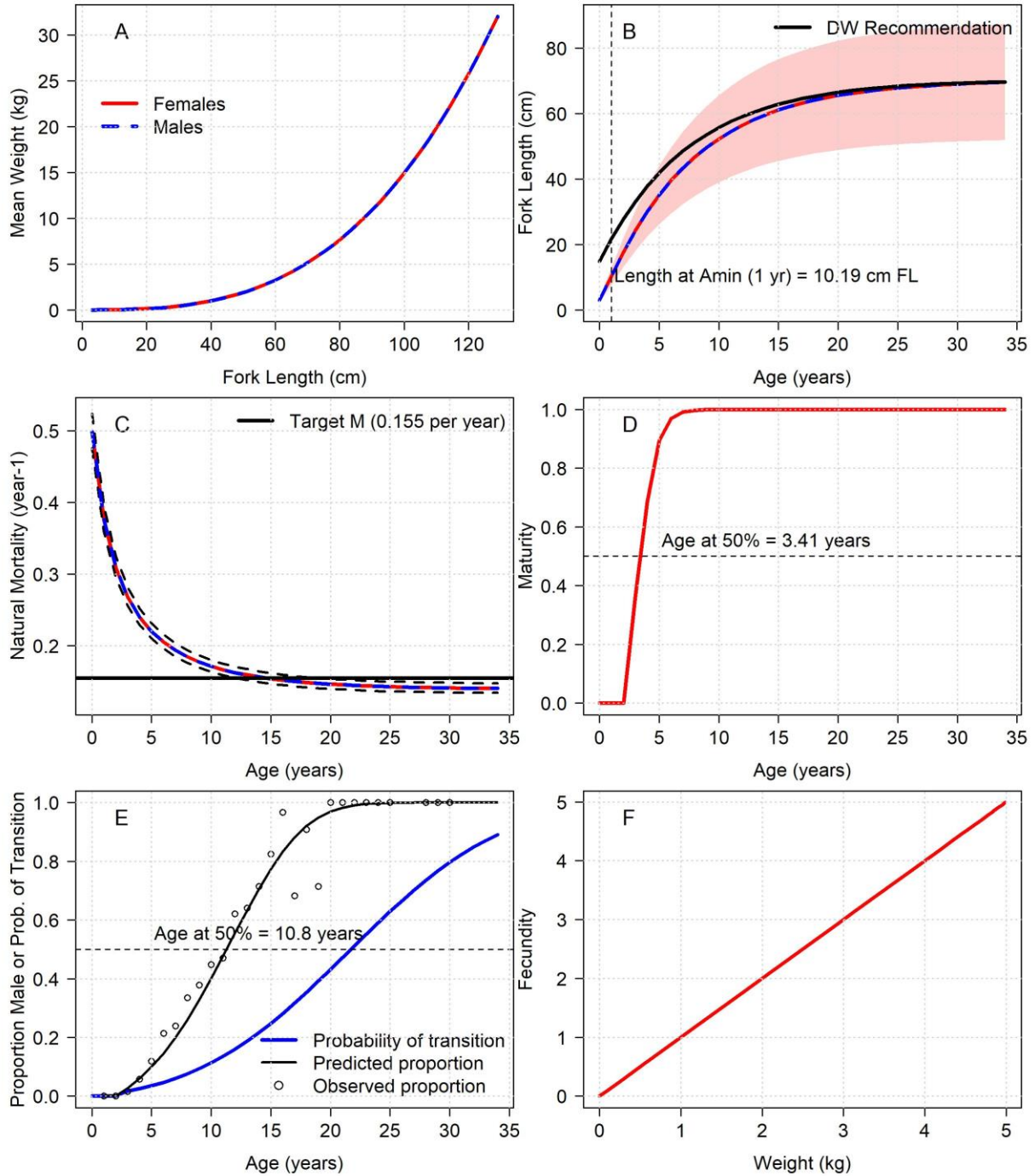

Figure 2. Life history relationships for Gulf of Mexico Scamp including (A) mean body weight-at-length, (B) recommended and estimated growth curves (shaded area indicates the 95% distribution of length-at-age), (C) natural mortality-at-age (dashes indicate low and high scenarios based on maximum age ± 2 years), (D) maturity-at-age, (E) the hermaphroditism transition rate (probability of transition and proportion male also shown but not required by SS as an input), and (F) fecundity at weight.

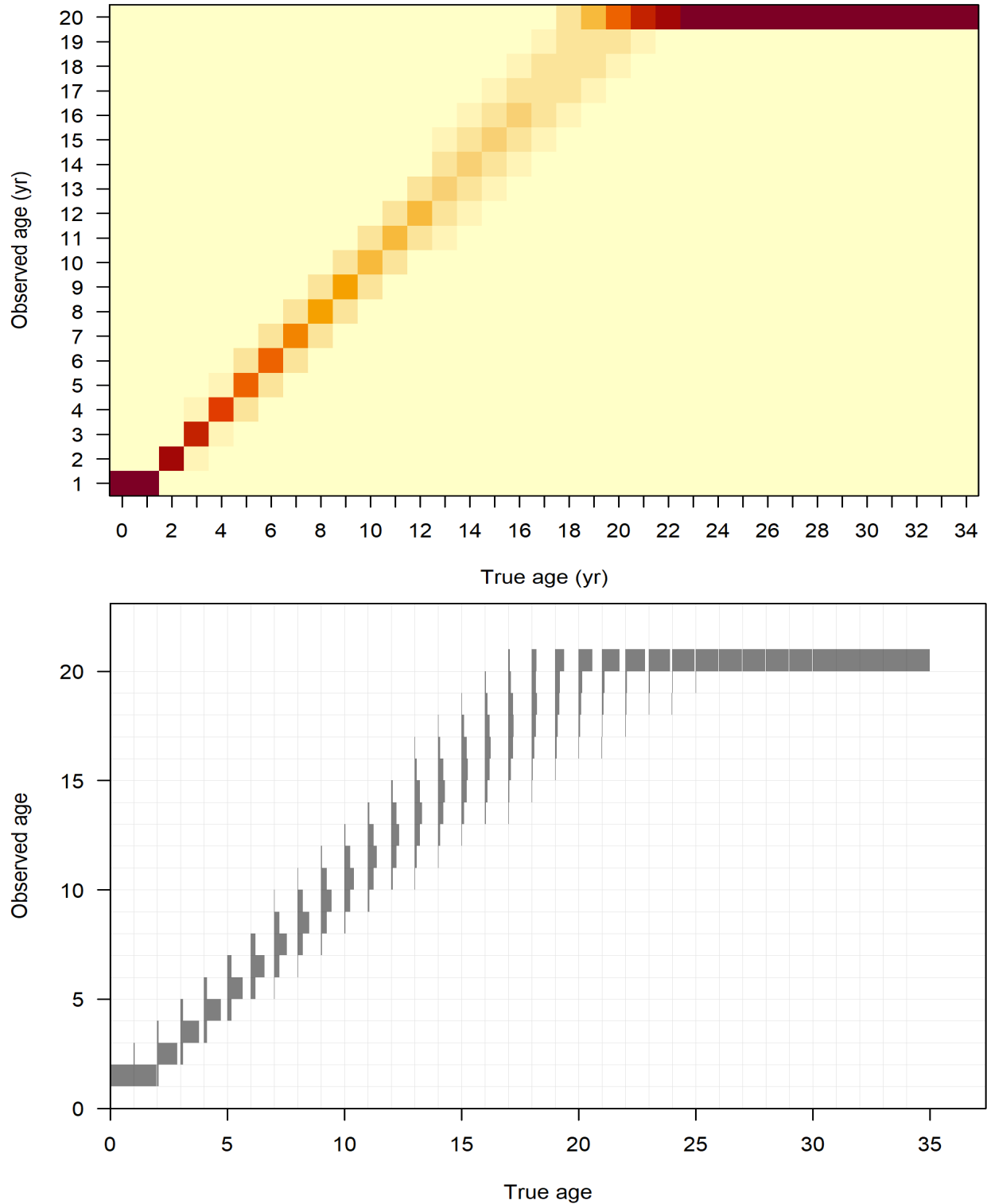

Figure 3. Ageing error matrix (top panel) and distribution of observed age at true age for Gulf of Mexico Scamp.

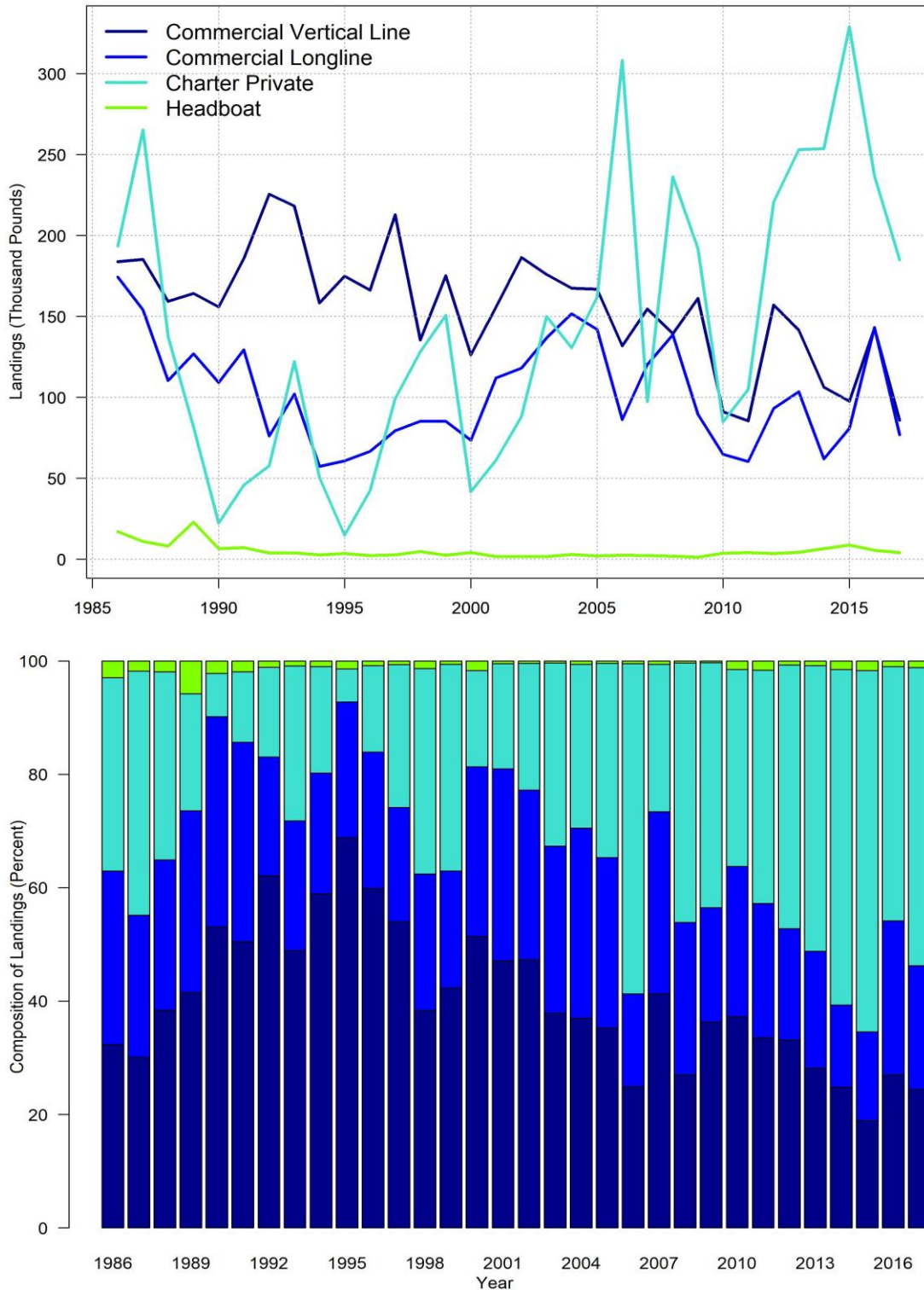

Figure 4. Observed landings by fleet and by proportion for Gulf of Mexico Scamp. Commercial and recreational landings are shown in thousands of pounds but input into the SEDAR 68 AP Base Model in units of metric tons.

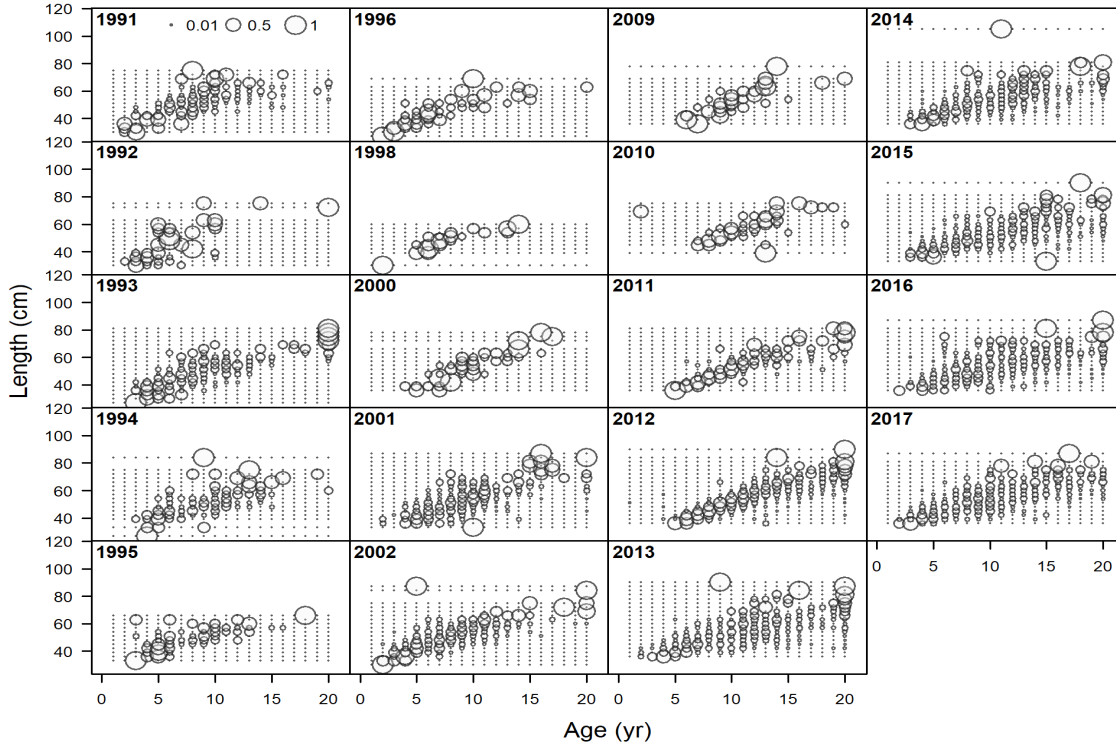

Figure 5A. Observed conditional age-at-length composition data for Gulf of Mexico Scamp retained by the Commercial Vertical Line fleet.

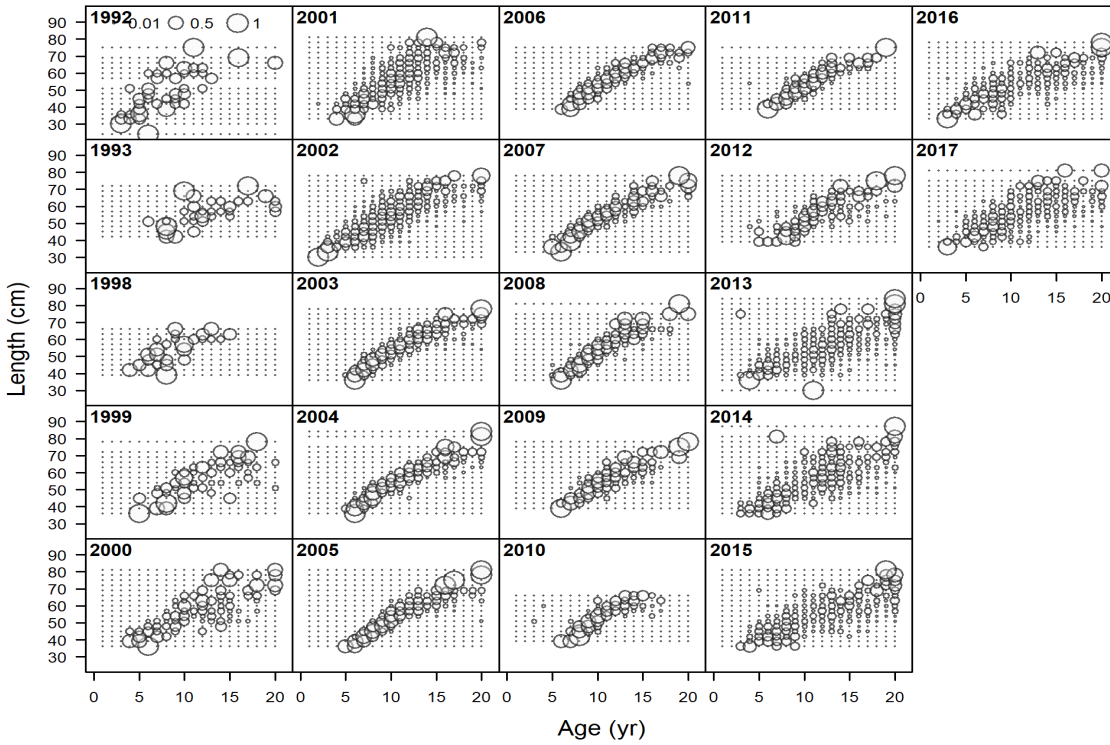

Figure 5B. Observed conditional age-at-length composition data for Gulf of Mexico Scamp retained by the Commercial Longline fleet.

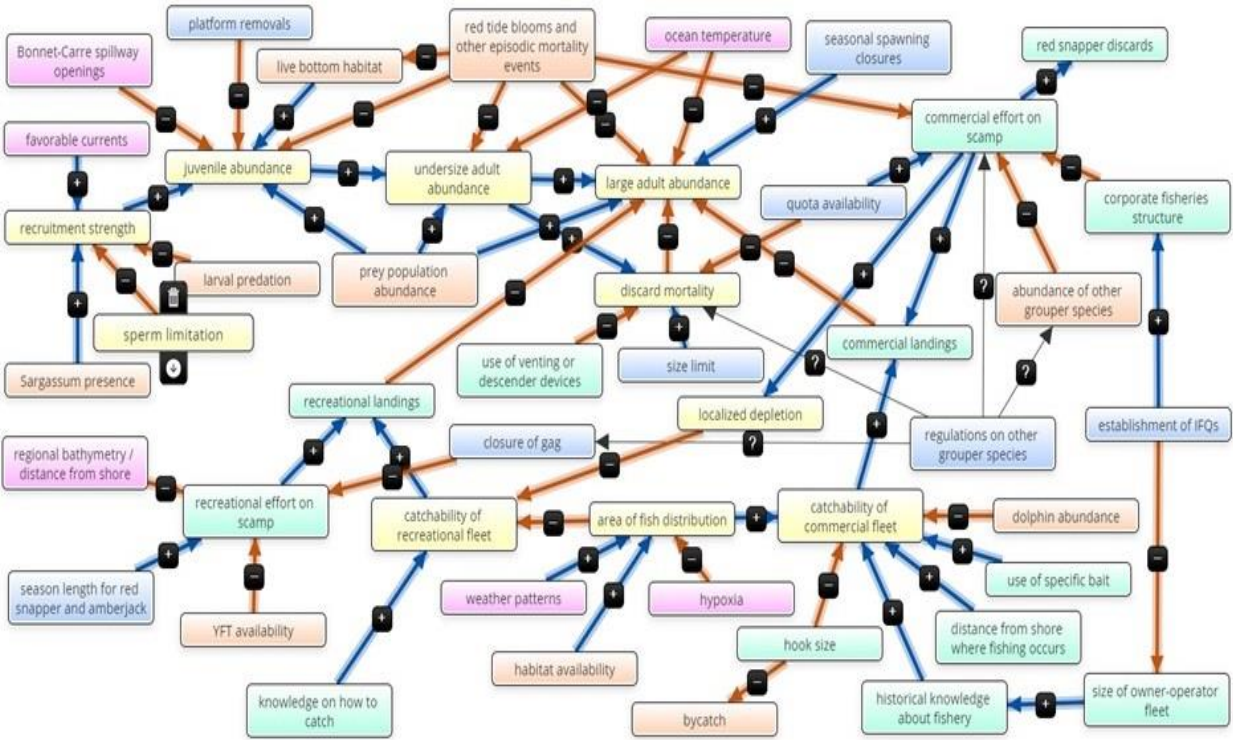

Figure 6. Scamp-centric system conceptual model for the Gulf of Mexico. Model components are color-coded as follows: pink - physical factors; orange - biological factors; yellow - Scamp population dynamics; green - socioeconomic factors; and blue - regulatory factors.

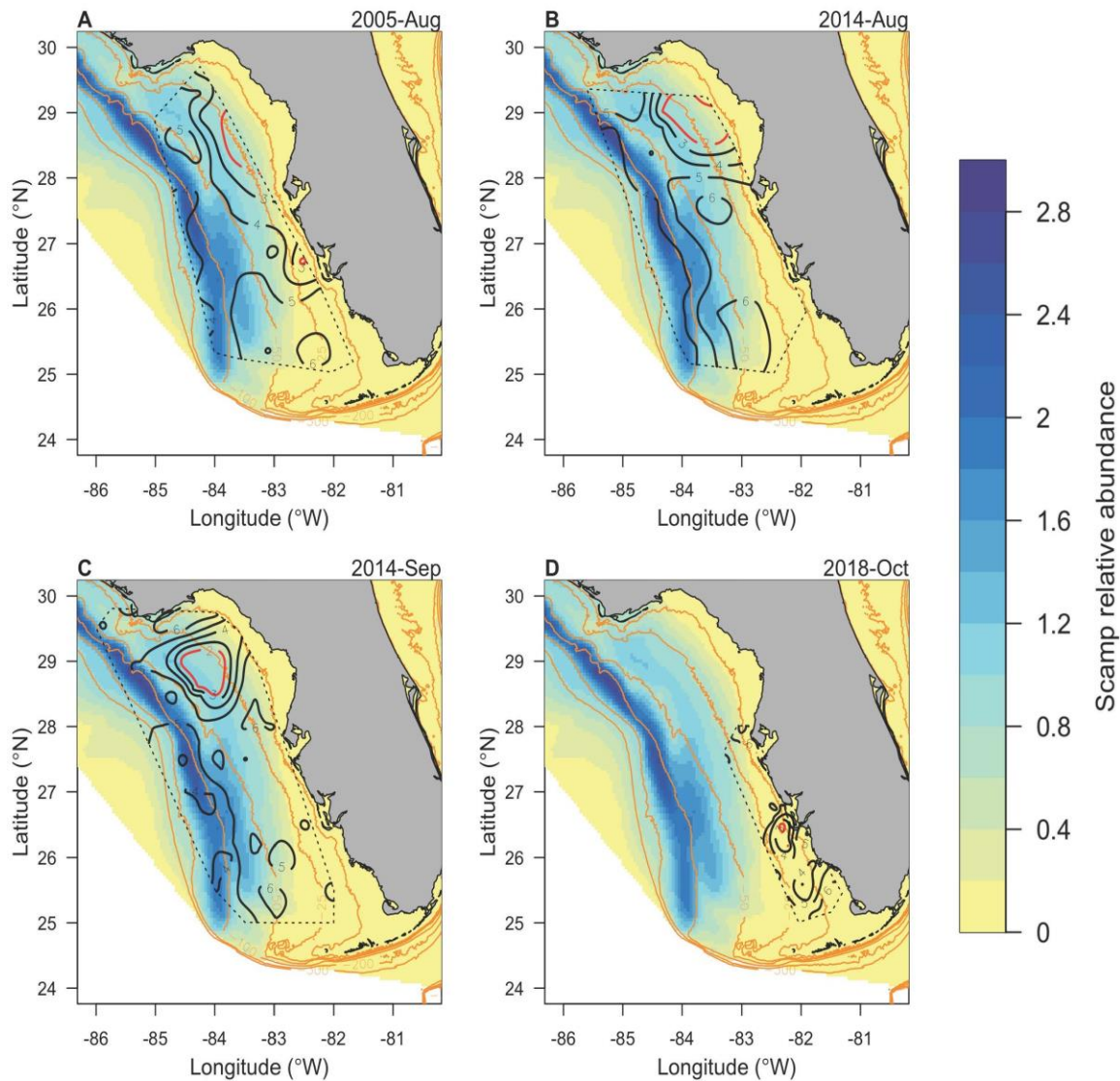

Figure 7. Overlap between the output of a scamp distribution model (filled contours; see SEDAR68-SID-02 for details) and interpolated bottom oxygen concentrations (black and red contour lines; see SEDAR72-WP-10 for details) from CTD data. The four plots represent the months in which hypoxic events were evident in two or more CTD casts per month across data available in 2003-2019. Red contour lines correspond to dissolved oxygen 2 mg/l or less, which is the typical literature value considered to be hypoxic. The dashed black line indicates the convex hull used for the boundary of the interpolation surface. Bathymetric contours at 10, 25, 50, 100, 200, and 300m are in orange.

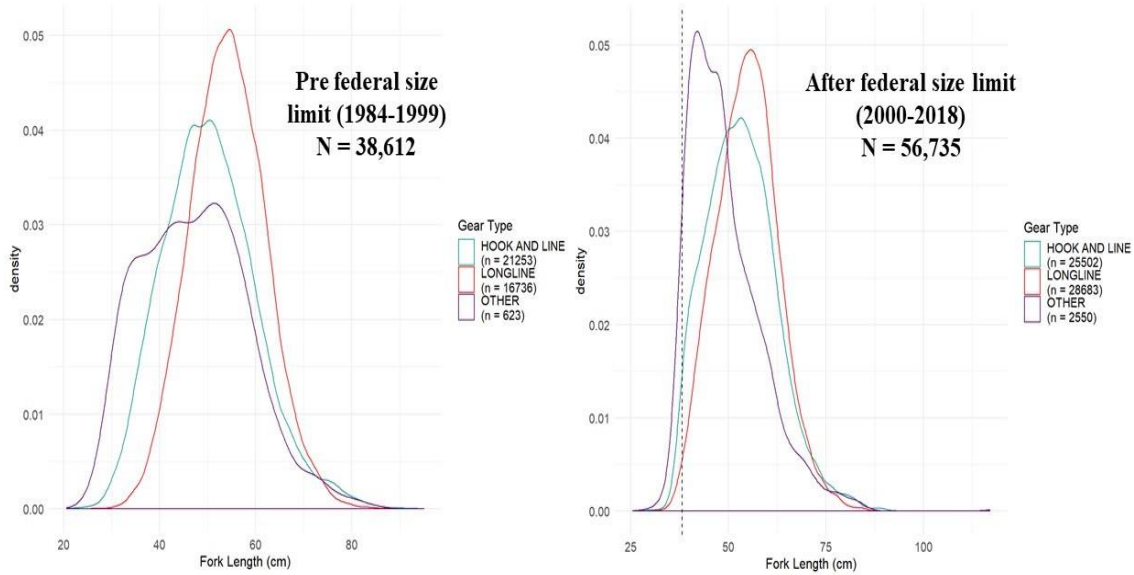

Figure 8A. Comparison of length distributions aggregated across years by commercial gear types (with corresponding sample sizes) before and after the implementation of the federal size limit of 16 inches TL (~38 cm FL) in 1999.

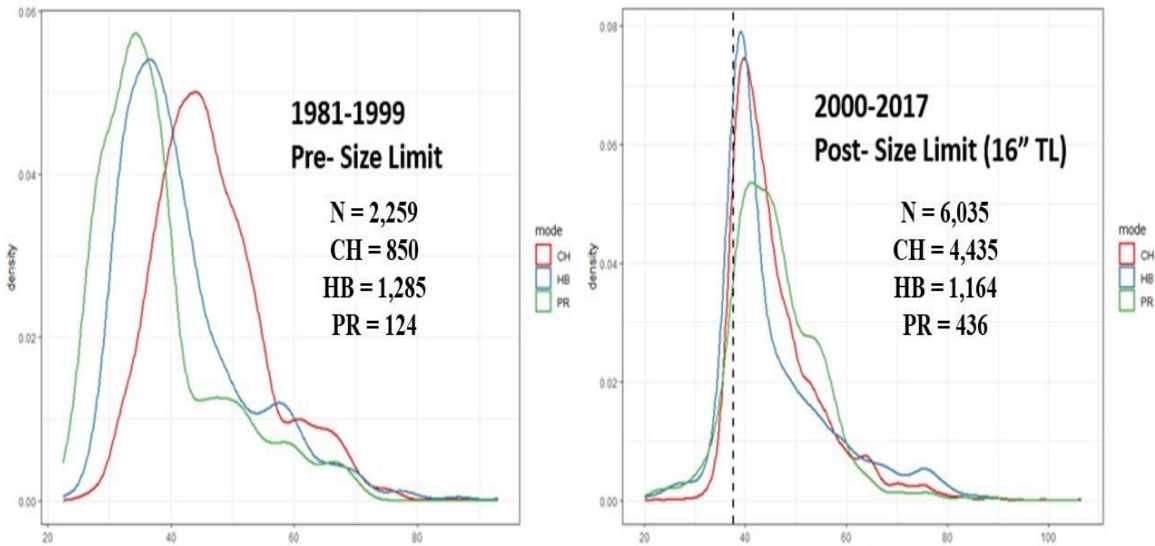

Figure 8B. Comparison of length distributions aggregated across years by recreational mode (with corresponding sample sizes) before and after the implementation of the federal size limit of 16 inches TL (~38 cm FL) in 1999. Modes include Charter-boat (CH), Headboat (HB), and Private (PR).

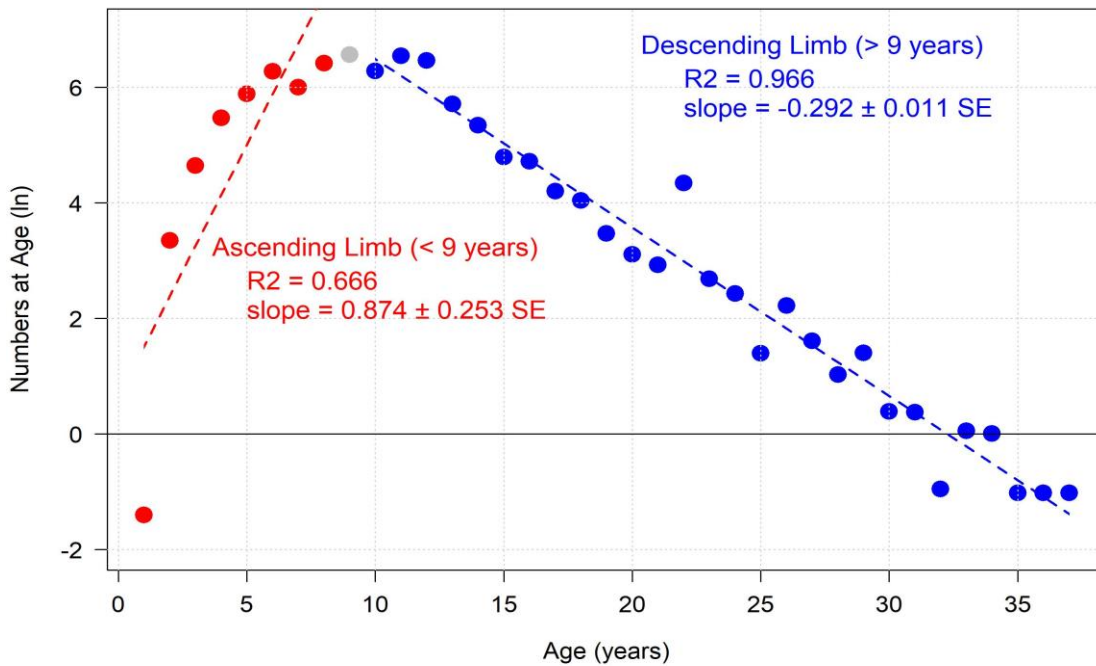

Figure 9A. Catch curve analysis from the aggregated Commercial Vertical Line data. The gray dot reflects the age fully selected for by vertical line gear.

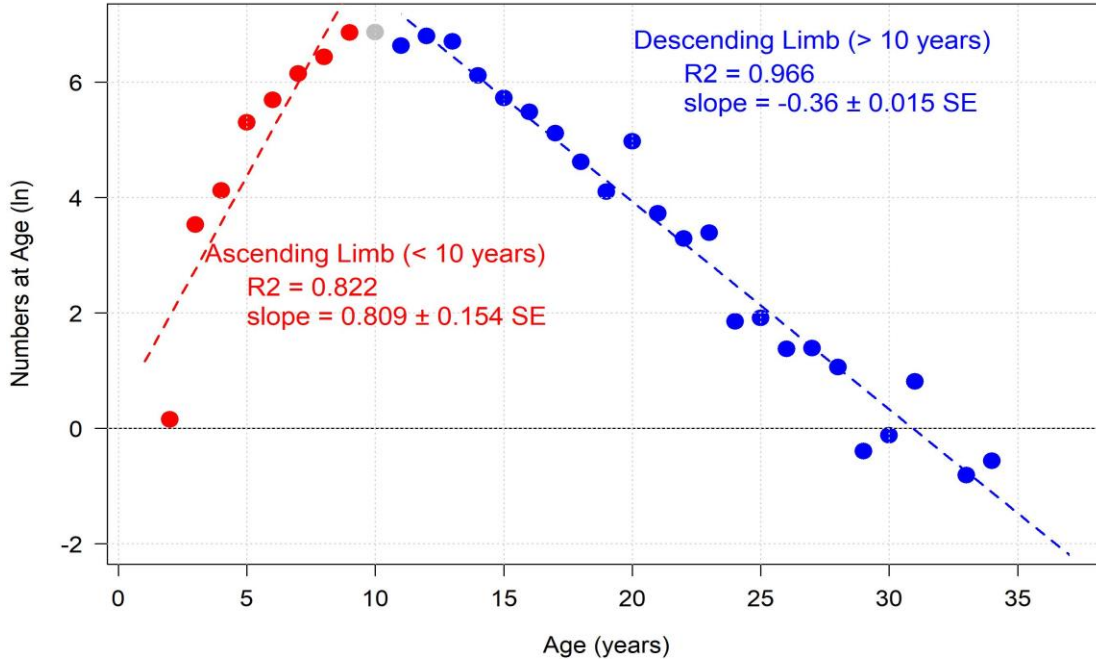

Figure 9B. Catch curve analysis from the aggregated Commercial Longline data. The gray dot reflects the age fully selected for by longline gear.

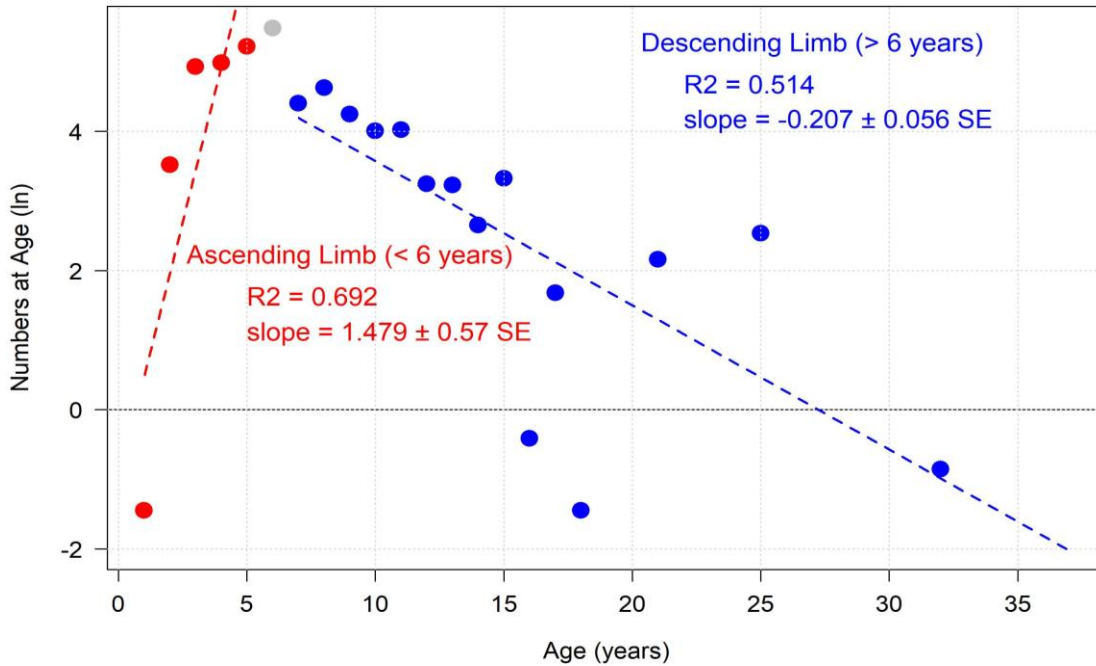

Figure 9C. Catch curve analysis from the aggregated Recreational Charter Private data. The gray dot reflects the age fully selected for by the gear (primarily hook and line).

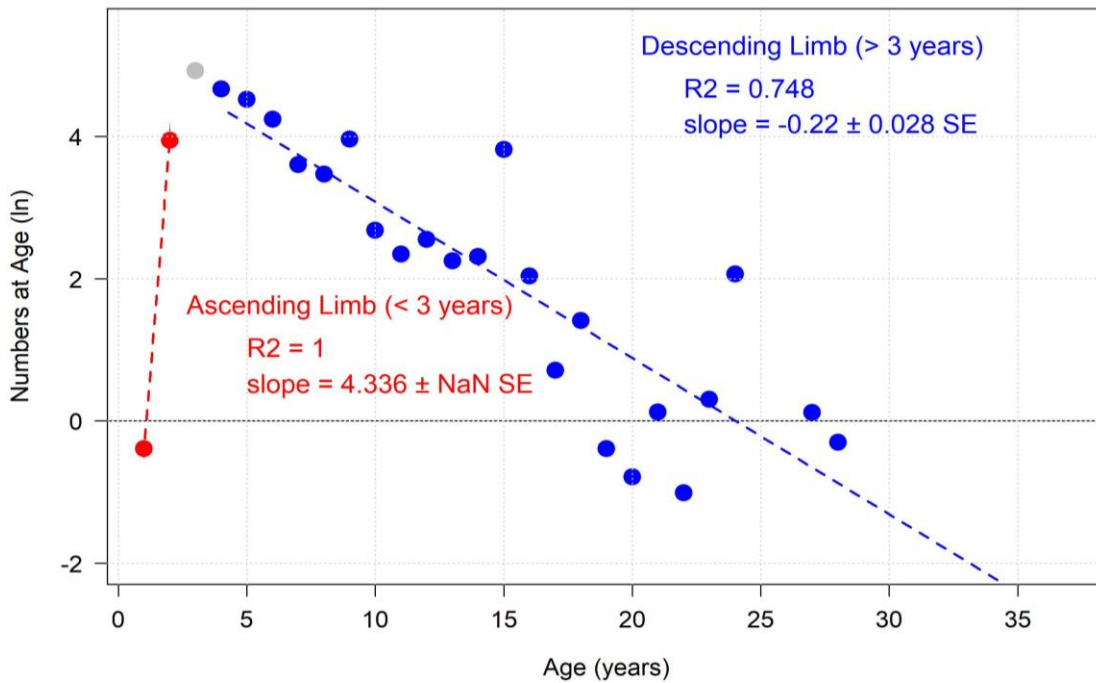

Figure 9D. Catch curve analysis from the aggregated Recreational Headboat data. The gray dot reflects the age fully selected for by the gear (primarily hook and line).

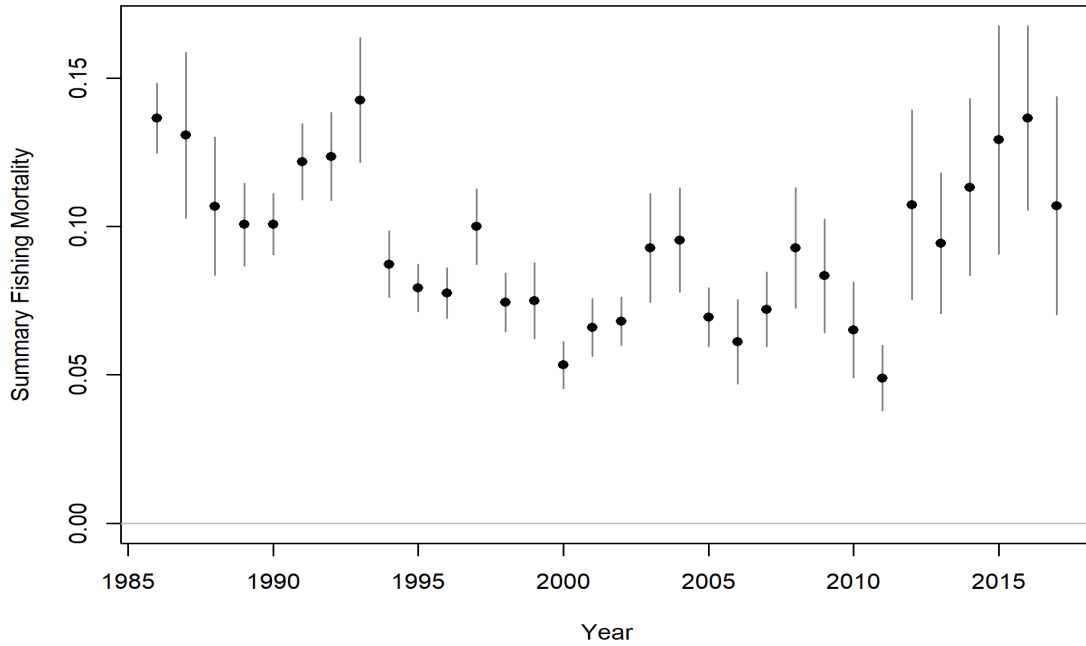

Figure 11. Annual exploitation rate (total biomass killed age 3+ / total biomass age 3+) for Gulf of Mexico Scamp.

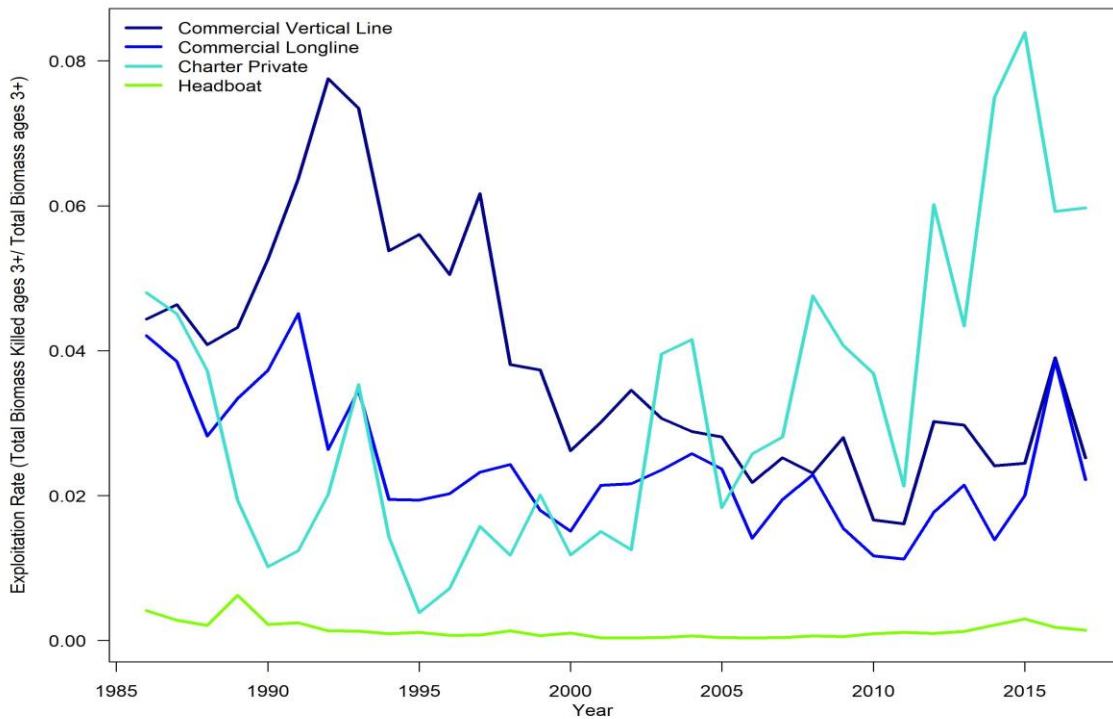

Figure 12. Annual exploitation rate (total biomass killed age 3+ / total biomass age 3+) by fleet for Gulf of Mexico Scamp.

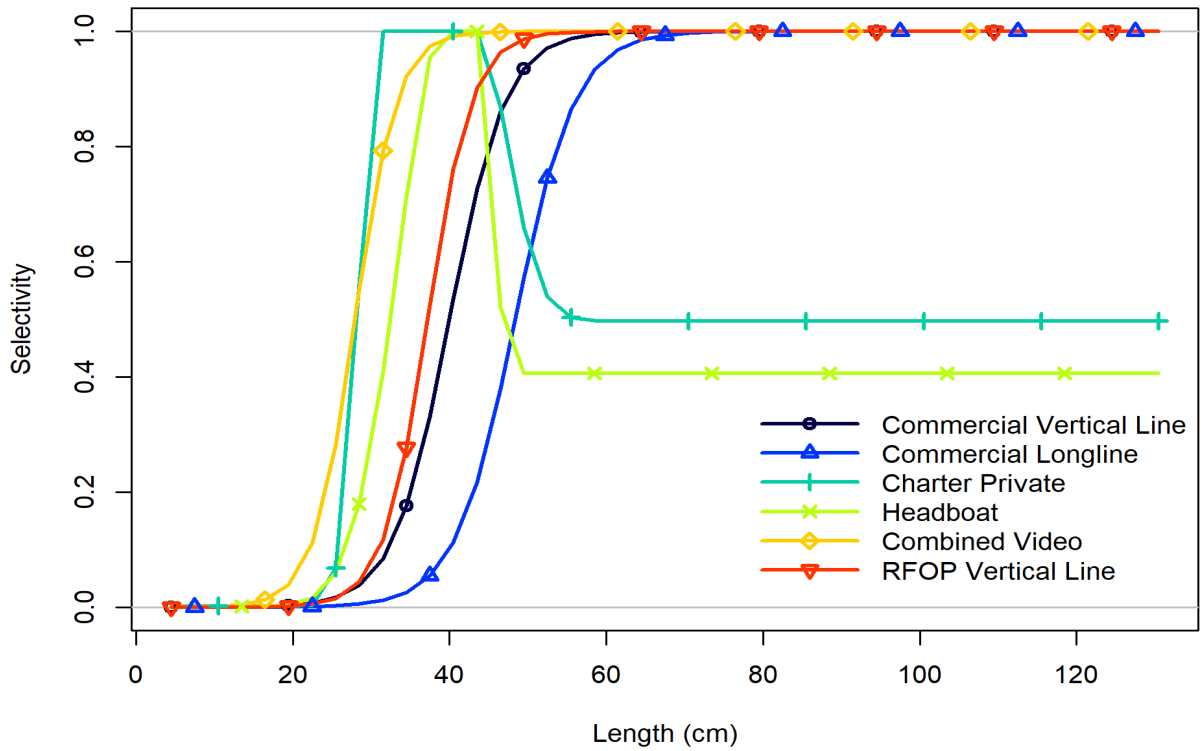

Figure 13. Length-based selectivity for each fleet and survey for Gulf of Mexico Scamp in the terminal year of the assessment, 2017.

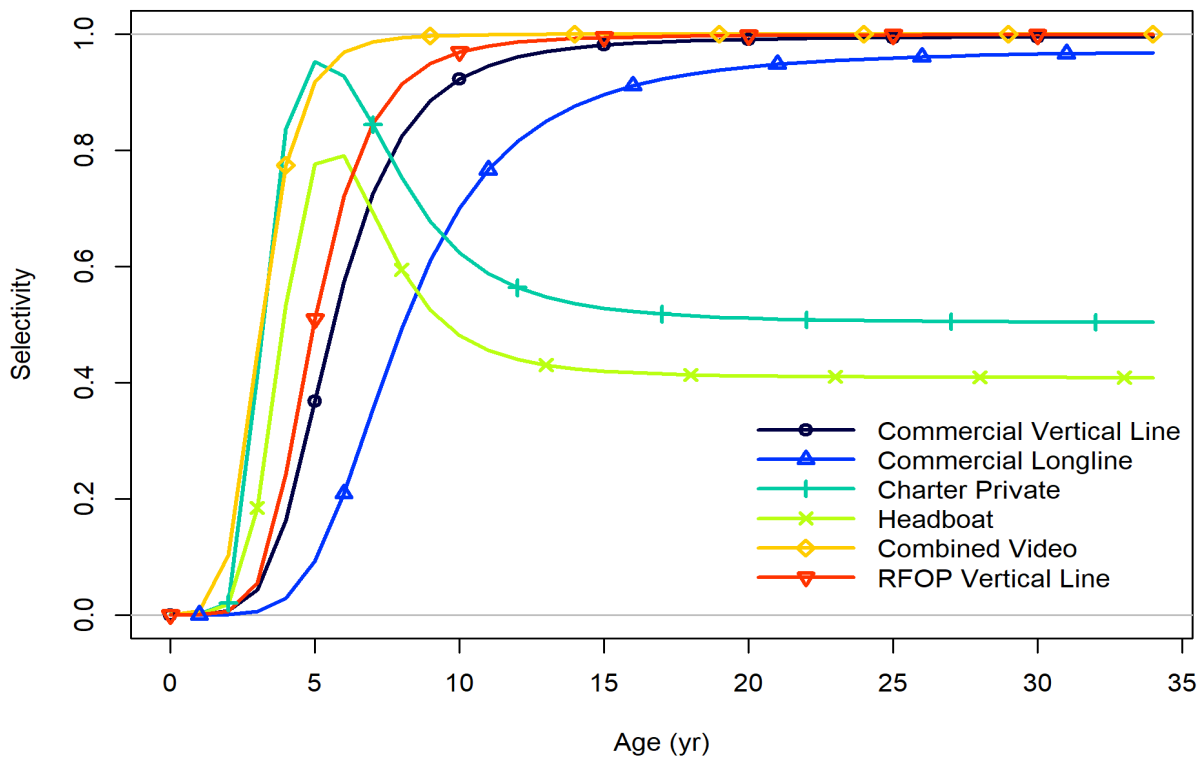

Figure 14. Derived age-based selectivity for each fleet and survey for Gulf of Mexico Scamp in the terminal year of the assessment, 2017.

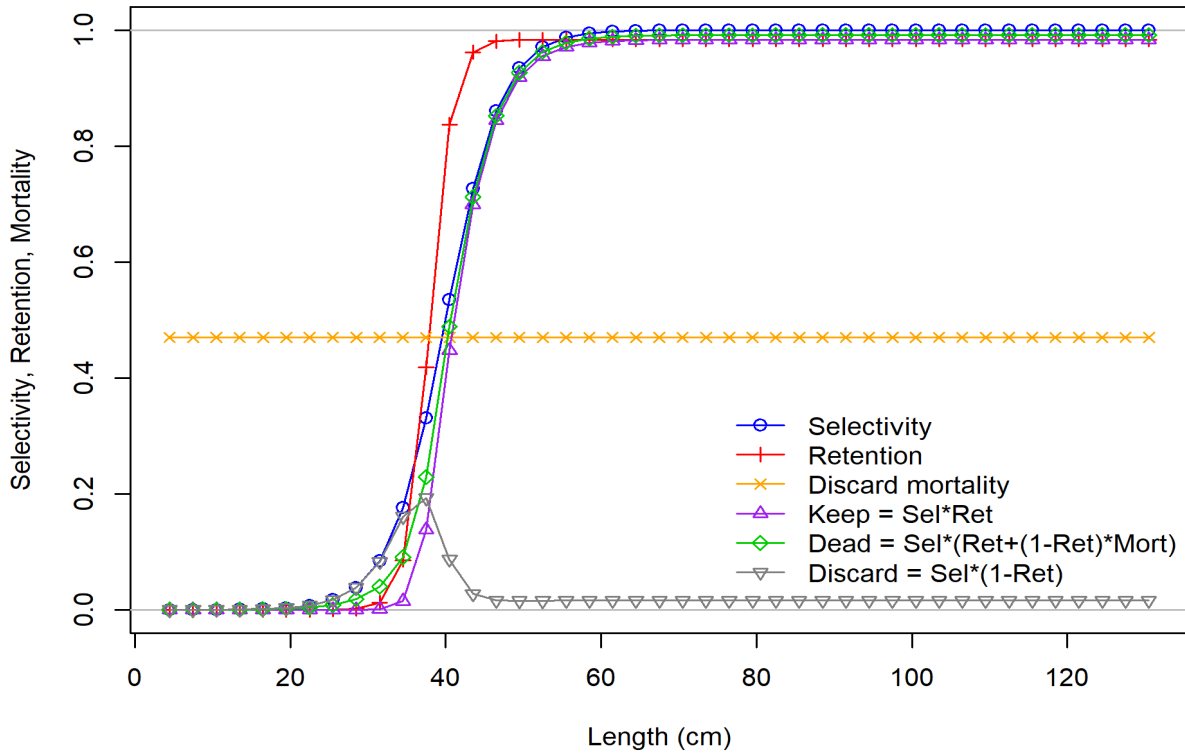

Figure 15A. Length-based selectivity and retention for the Commercial Vertical Line fleet in the terminal year of the assessment, 2017. Selectivity (blue line) is constant over the entire assessment time period (1986 - 2017). Retention (red line) is shown for the most recent time period. Discard mortality (orange line) is constant at 0.47.

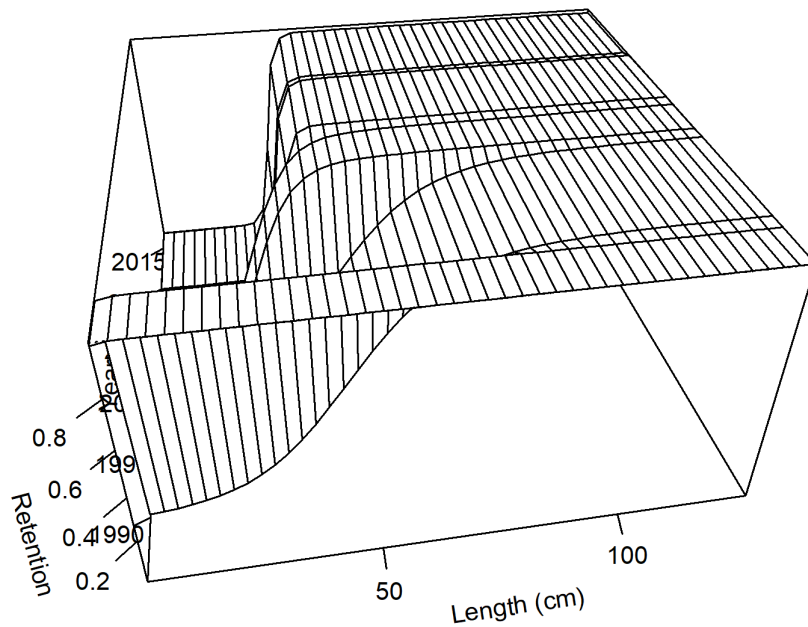

Figure 15B. Time-varying retention at length for the Commercial Vertical Line fleet for Gulf of Mexico Scamp.

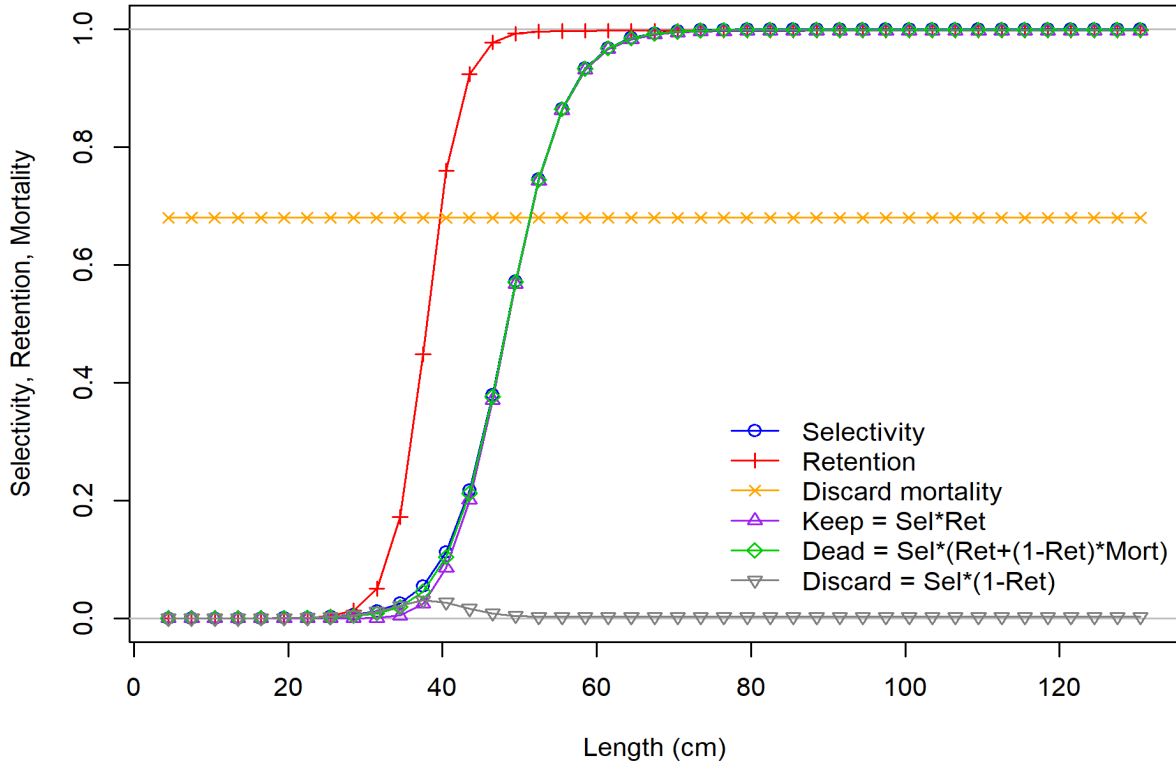

Figure 15C. Length-based selectivity and retention for the Commercial Longline fleet in the terminal year of the assessment, 2017. Selectivity (blue line) is constant over the entire assessment time period (1986 - 2017). Retention (red line) is shown for the most recent time period. Discard mortality (orange line) is constant at 0.68.

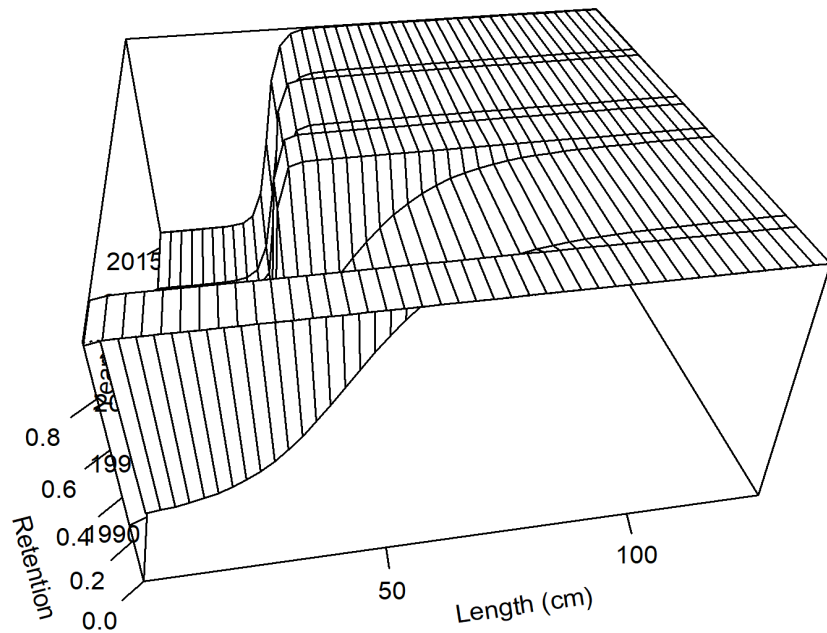

Figure 15D. Time-varying retention at length for the Commercial Longline fleet for Gulf of Mexico Scamp.

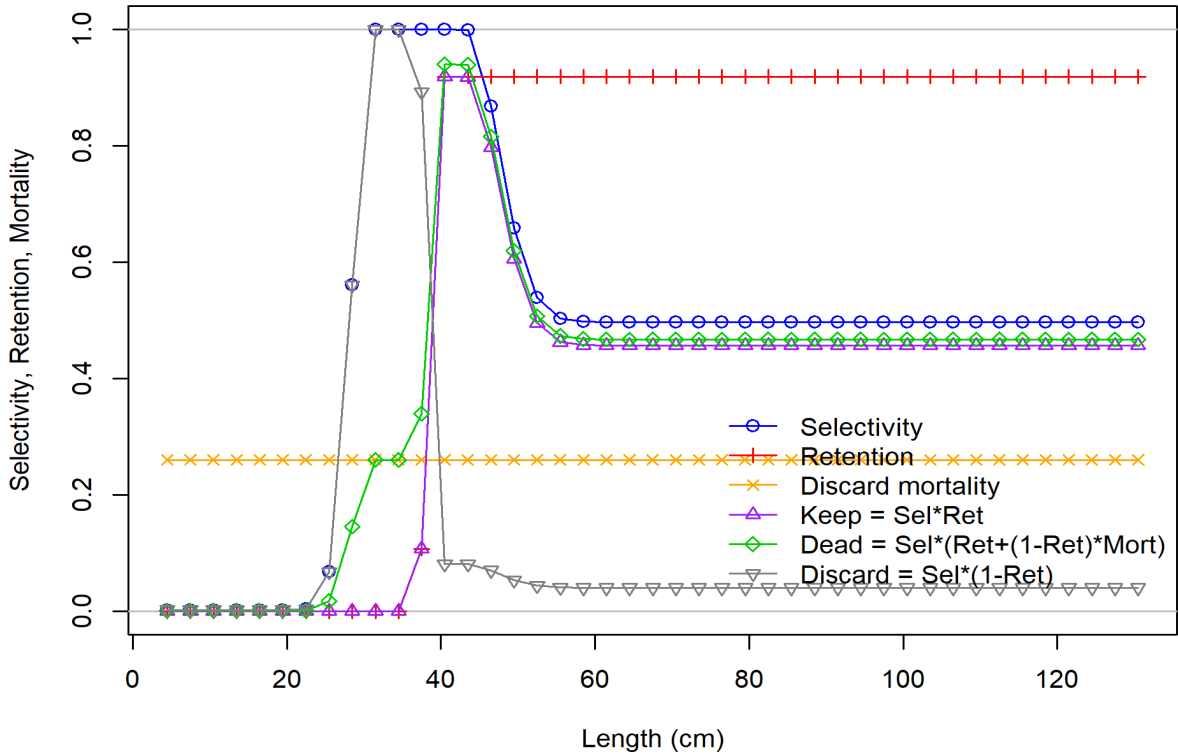

Figure 16A. Length-based selectivity and retention for the Recreational Charter Private fleet in the terminal year of the assessment, 2017. Selectivity (blue line) is constant over the entire assessment time period (1986 - 2017). Retention (red line) is shown for the most recent time period. Discard mortality (orange line) is constant at 0.26.

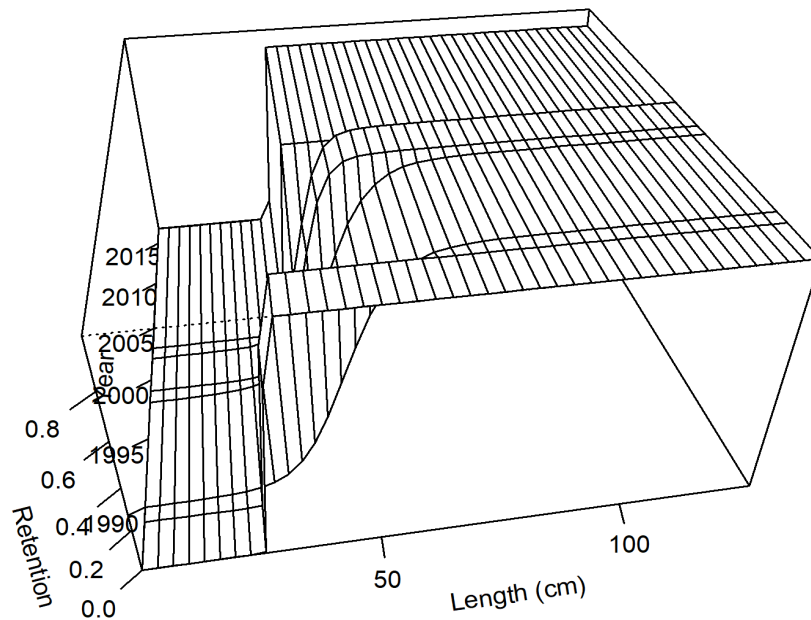

Figure 16B. Time-varying retention at length for the Recreational Charter Private fleet for Gulf of Mexico Scamp.

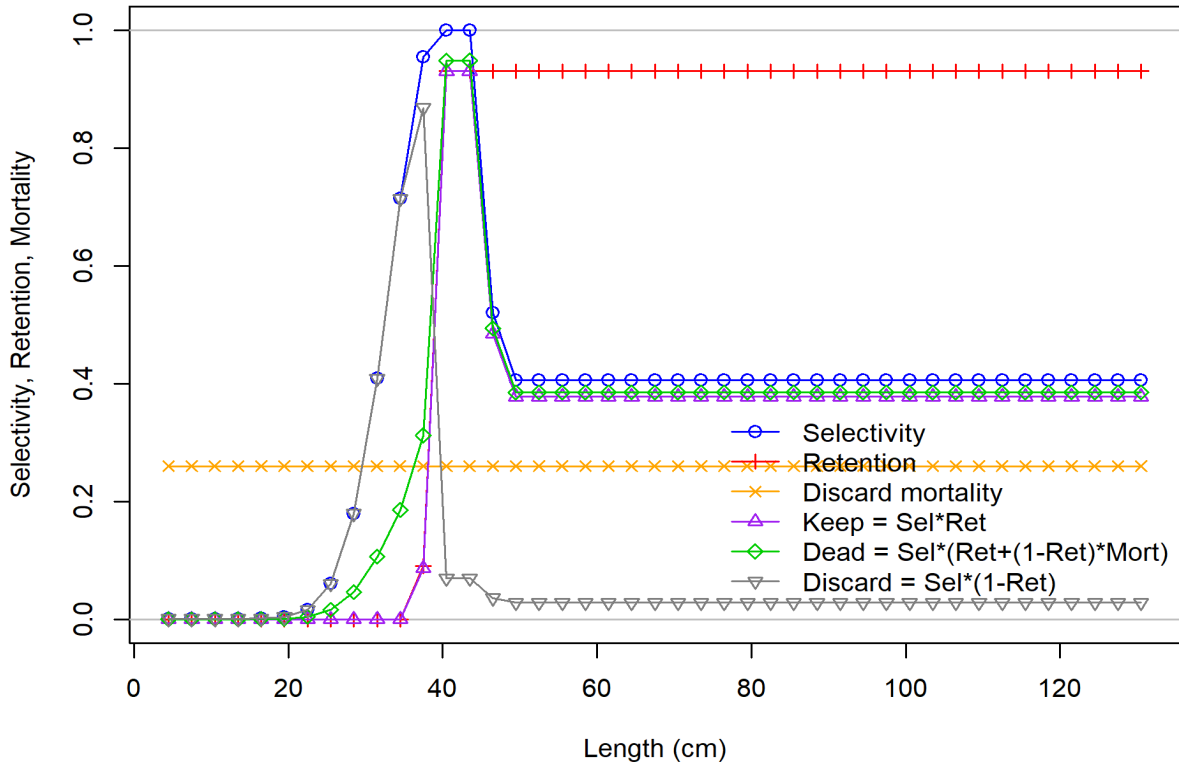

Figure 16C. Length-based selectivity and retention for the Recreational Headboat fleet in the terminal year of the assessment, 2017. Selectivity (blue line) is constant over the entire assessment time period (1986 - 2017). Retention (red line) is shown for the most recent time period. Discard mortality (orange line) is constant at 0.26.

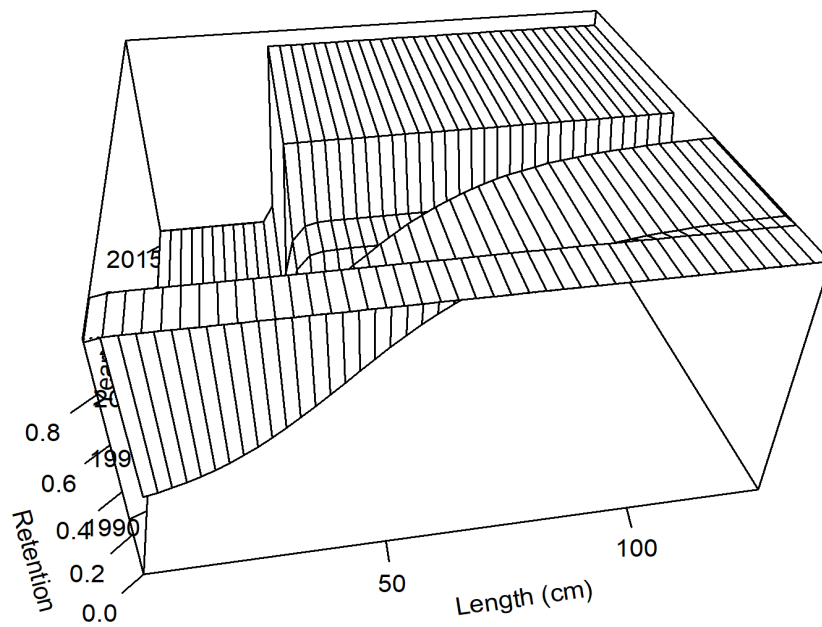

Figure 16D. Time-varying retention at length for the Recreational Headboat fleet for Gulf of Mexico Scamp.

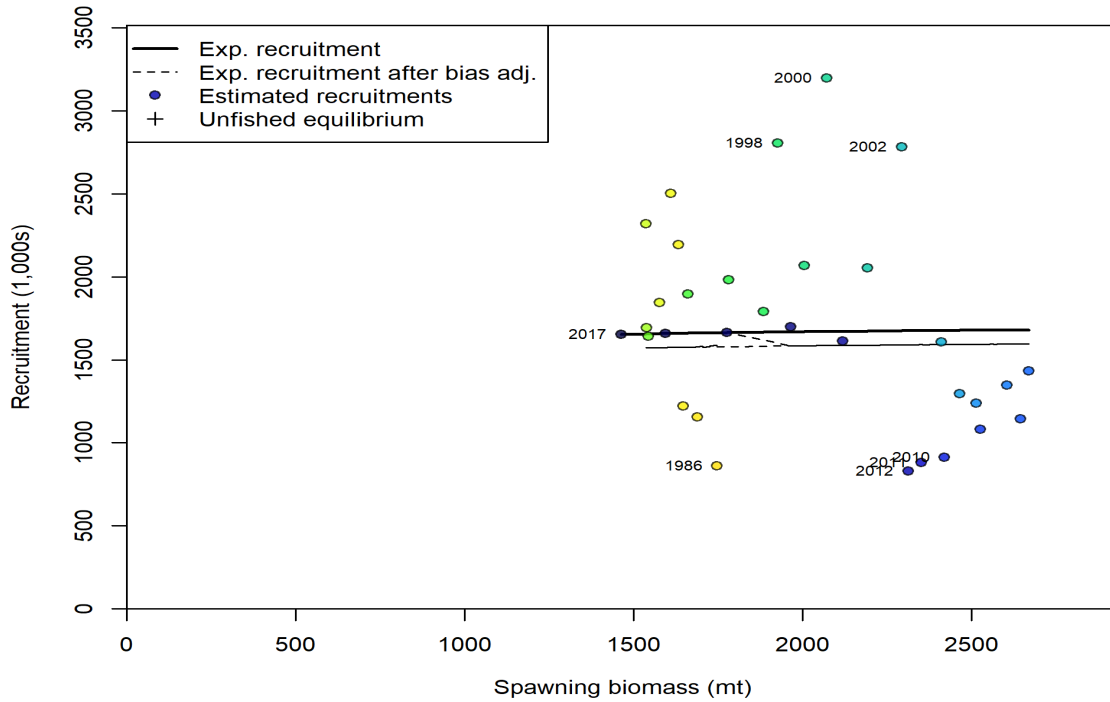

Figure 17. Expected stock-recruitment relationship for Gulf of Mexico Scamp. Steepness and SigmaR were estimated at 0.949 (0.041) and 0.356 (0.127), respectively. Plotted are expected annual recruitments from SS (circles), expected recruitment from the stock-recruit relationship (black line), and bias adjusted recruitment from the stock-recruit relationship (dashed line).

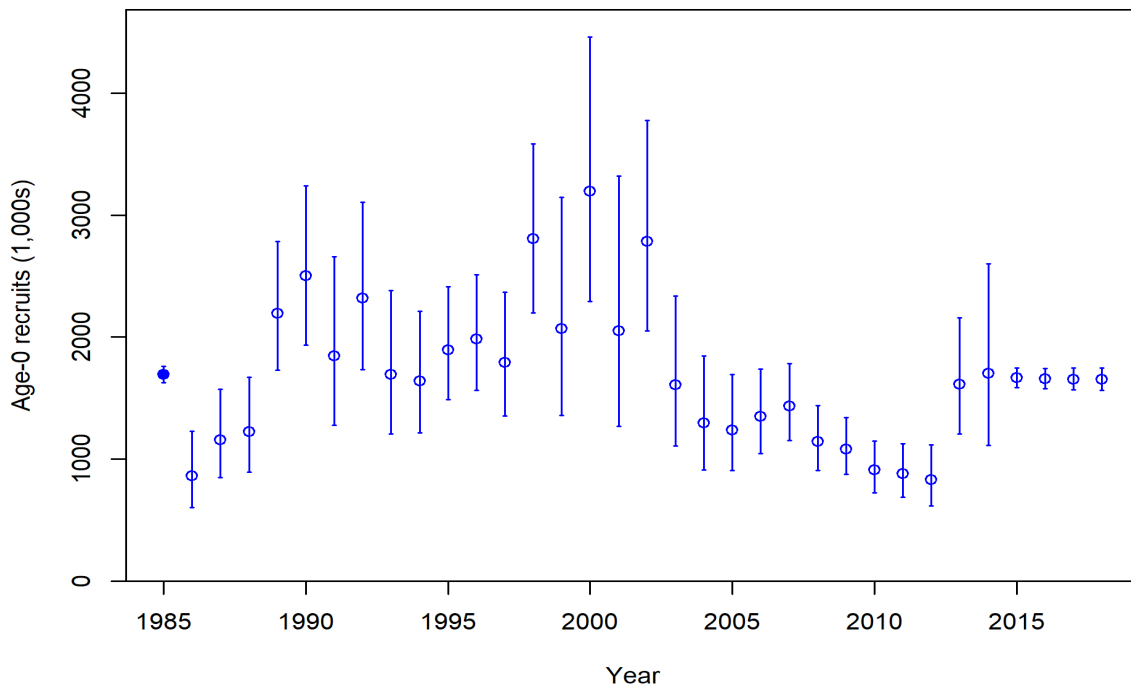

Figure 18. Estimated Age-0 recruitment with ~95% asymptotic intervals for Gulf of Mexico Scamp. Steepness and SigmaR were estimated at 0.949 (0.041) and 0.356 (0.127), respectively.

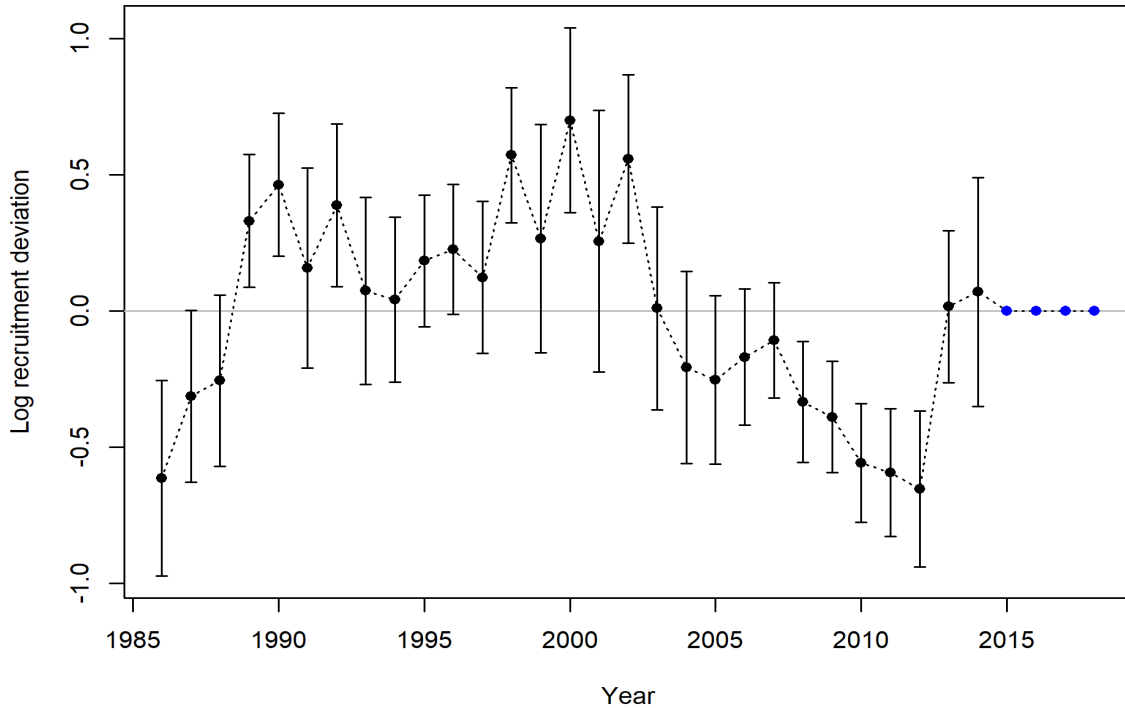

Figure 19. Estimated log-scale recruitment deviations with 95% confidence intervals for Gulf of Mexico Scamp. Steepness and SigmaR were estimated at 0.949 (0.041) and 0.356 (0.127), respectively.

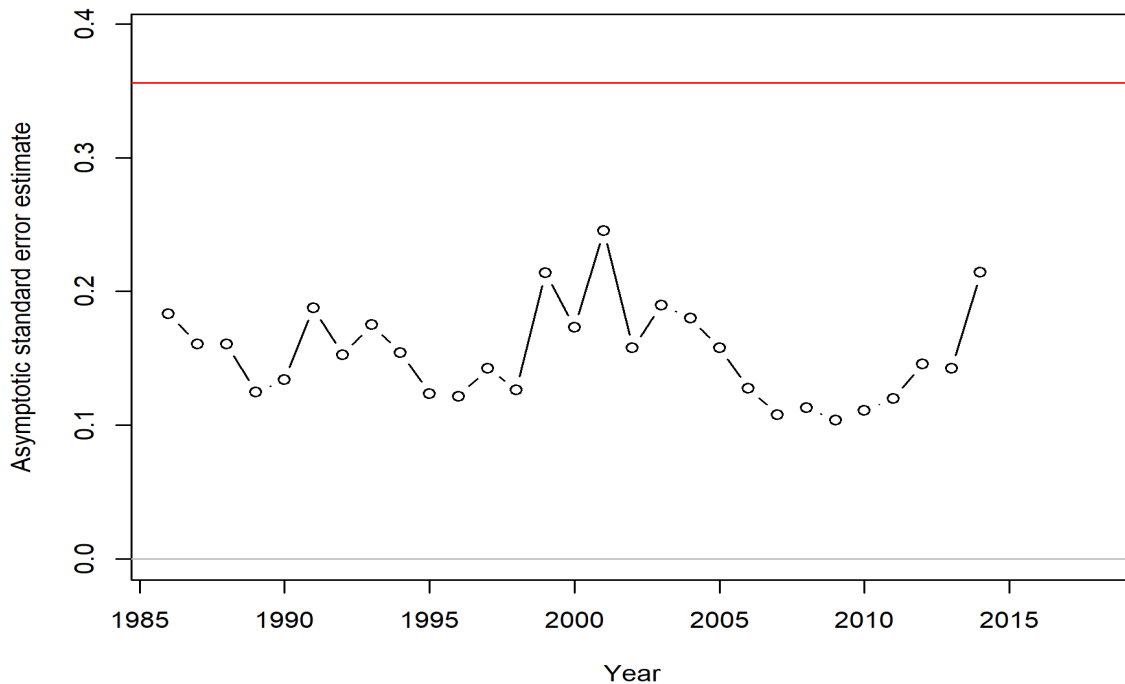

Figure 20. Asymptotic standard errors for recruitment deviations for Gulf of Mexico Scamp. Steepness and SigmaR (red horizontal line) were estimated at 0.949 (0.041) and 0.356 (0.127), respectively.

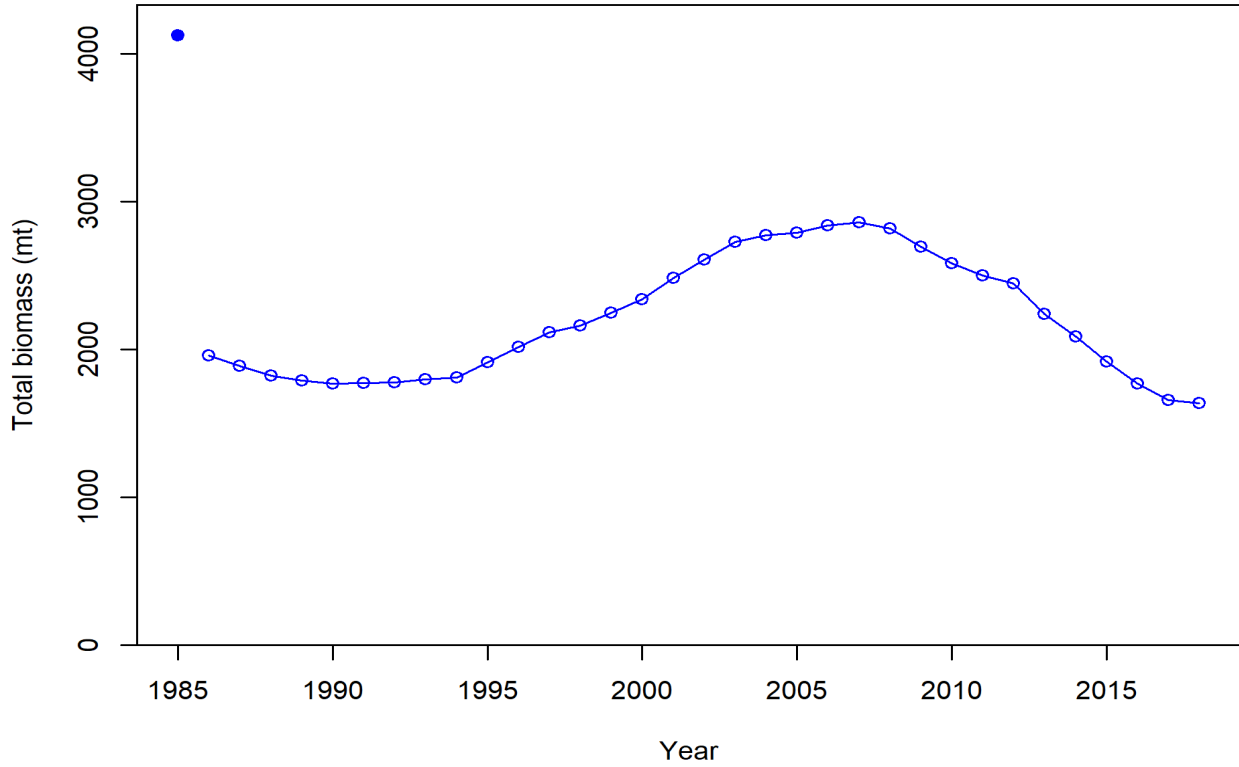

Figure 21. Estimate of total biomass (metric tons) for Gulf of Mexico Scamp.

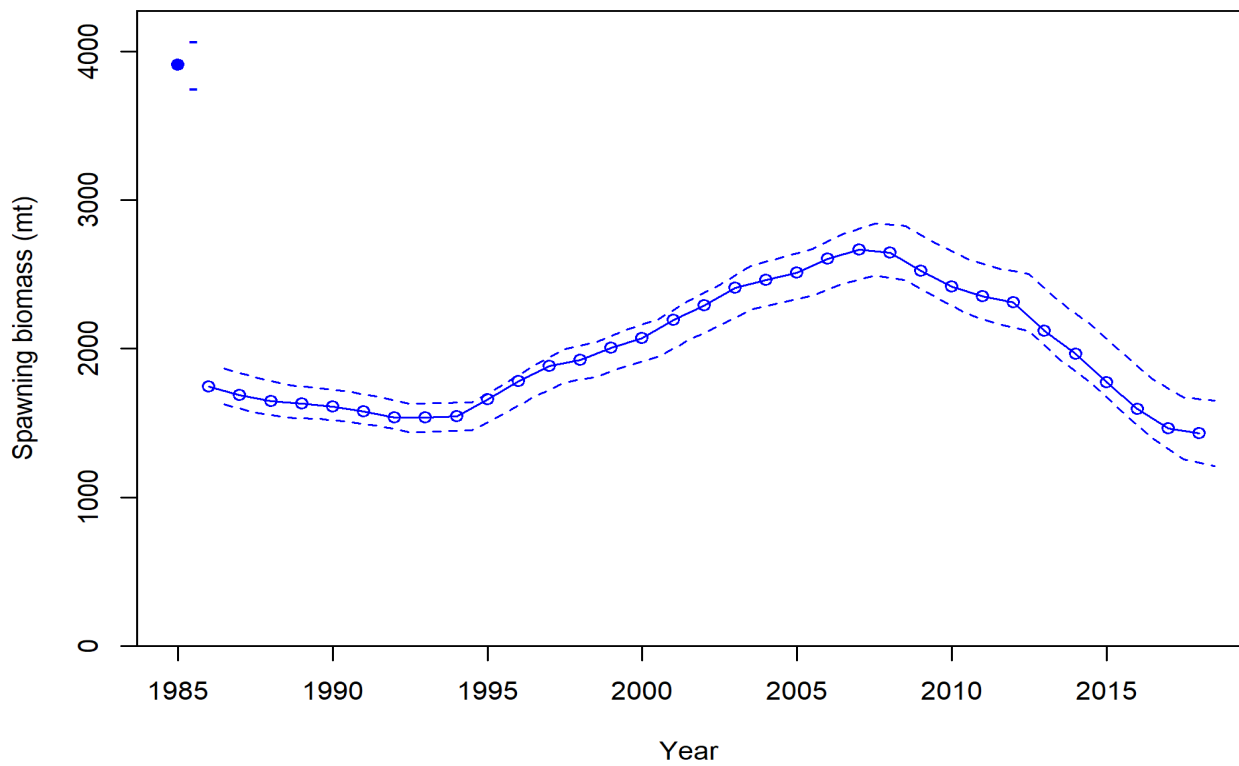

Figure 22. Estimate of spawning stock biomass (metric tons) with ~95% asymptotic intervals for Gulf of Mexico Scamp.

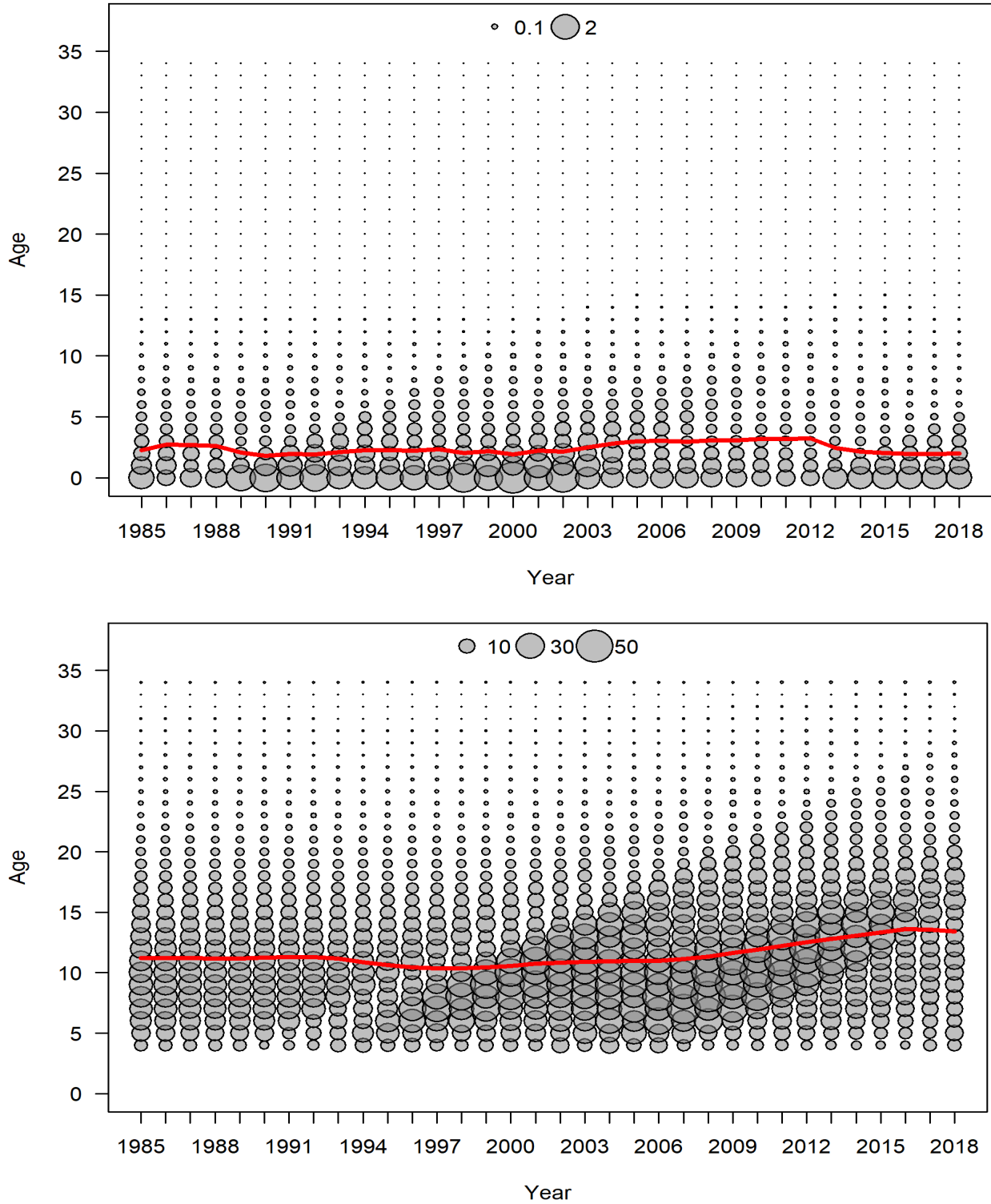

Figure 23A. Expected numbers-at-age (bubbles) and mean age (red line) of female (top; millions of fish) and male (bottom; thousands of fish) Gulf of Mexico Scamp.

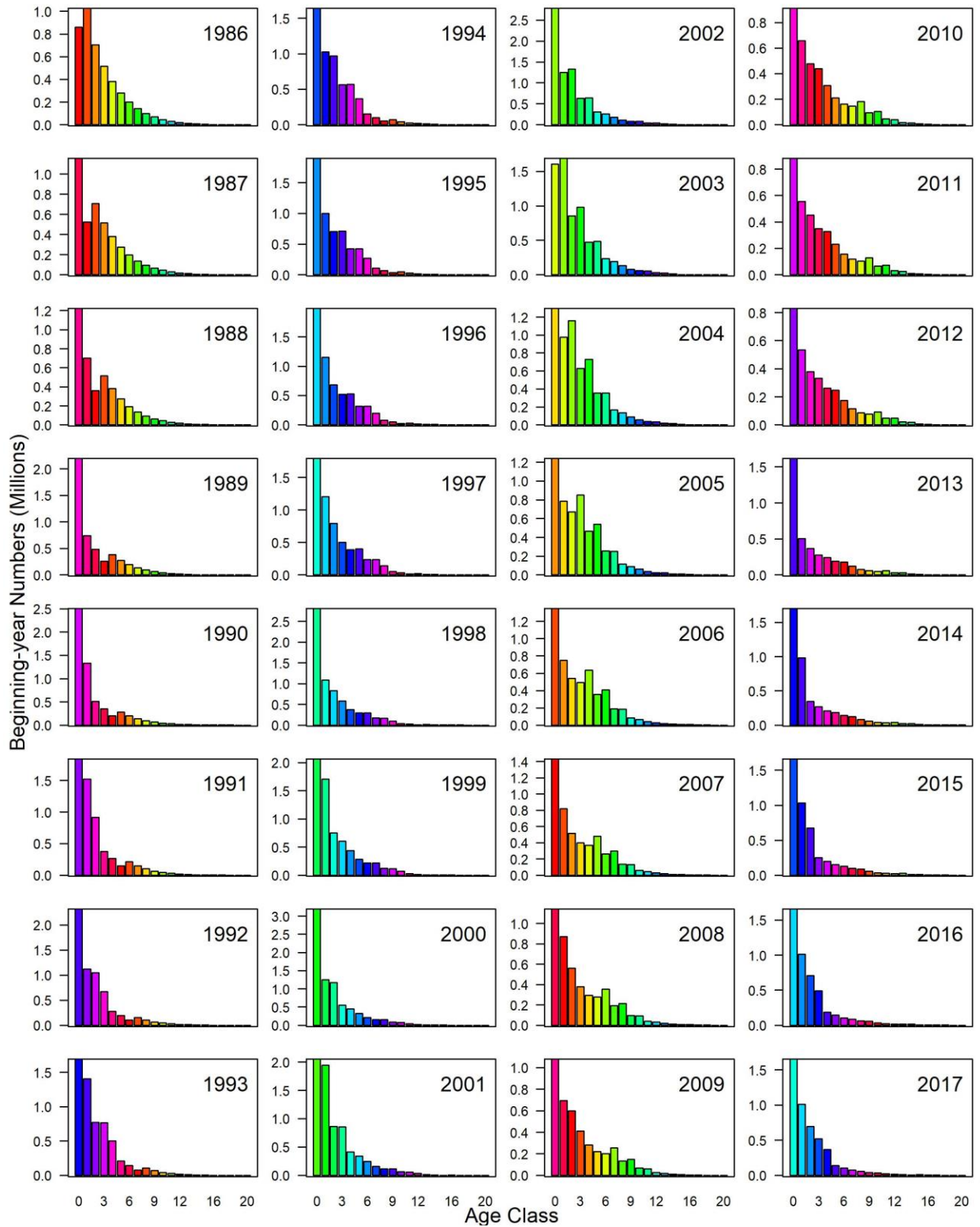

Figure 23B. Expected numbers-at-age (millions) at the beginning of each year (January 1st) for female Scamp in the Gulf of Mexico. Note that y-axes differ between panels and colors track cohorts across years.

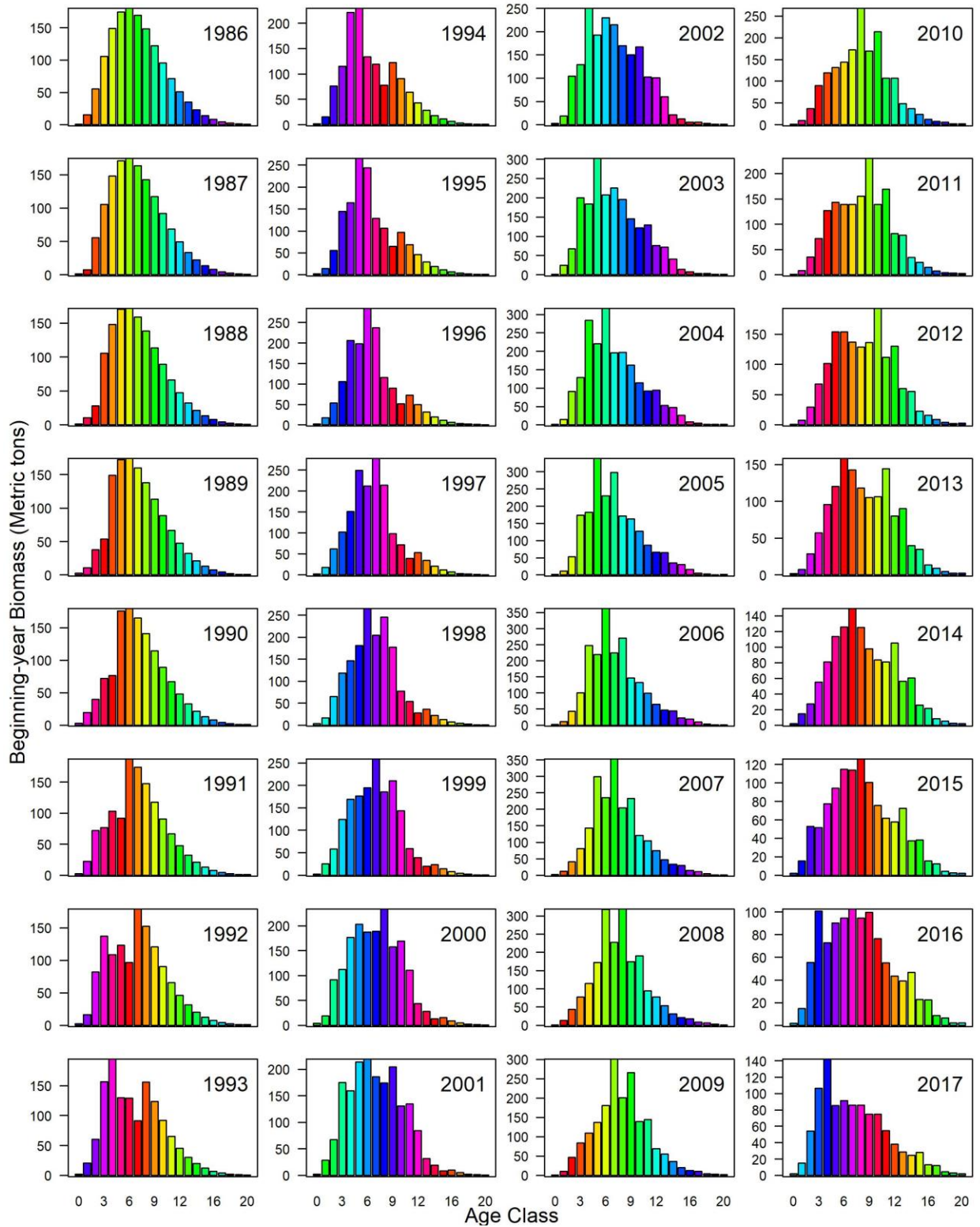

Figure 23C. Expected biomass-at-age (metric tons) at the beginning of each year (January 1st) for female Scamp in the Gulf of Mexico. Note that y-axes differ between panels and colors track cohorts across years.

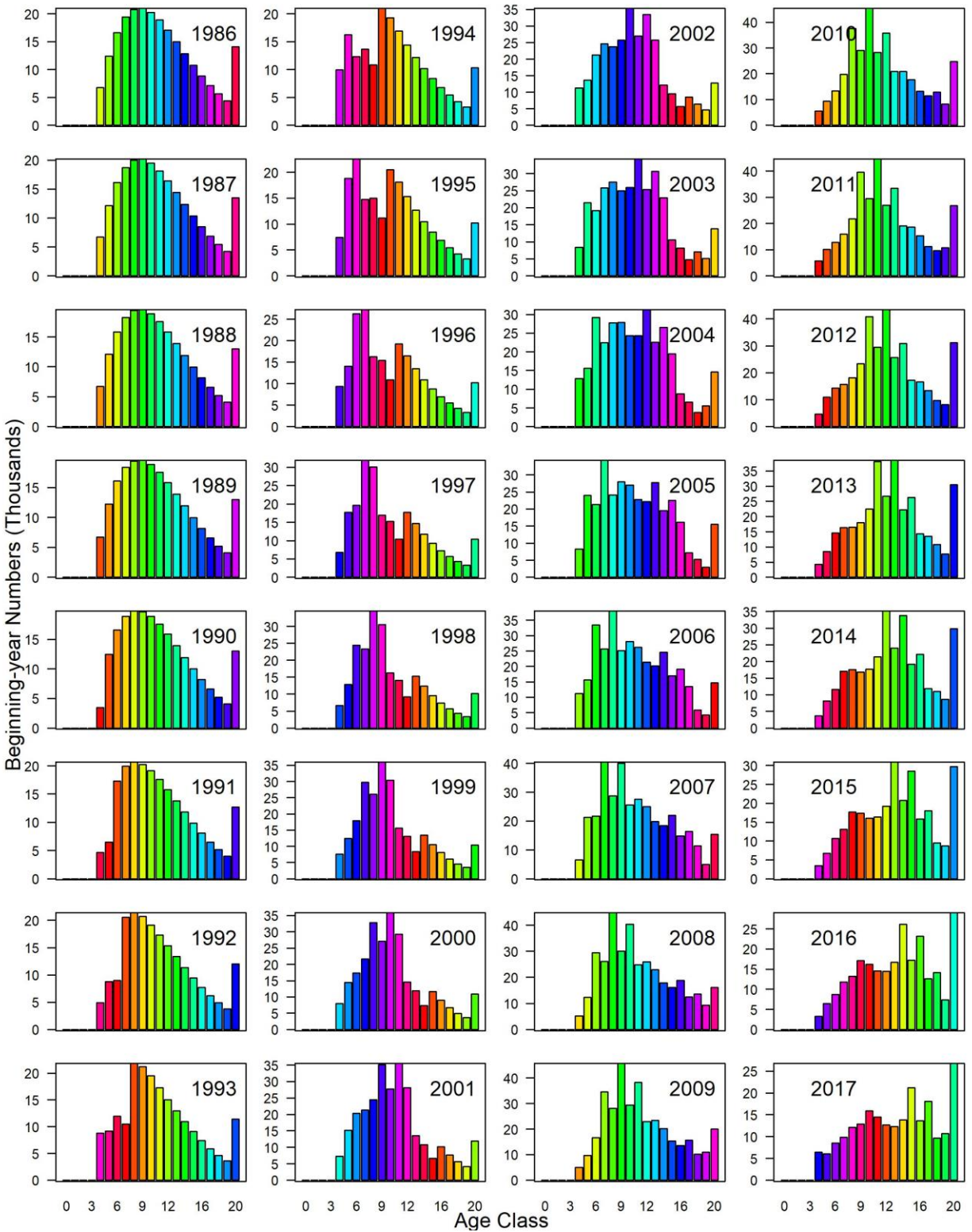

Figure 23D. Expected numbers-at-age (thousands) at the beginning of each year (January 1st) for male Scamp in the Gulf of Mexico. Note that y-axes differ between panels and colors track cohorts across years.

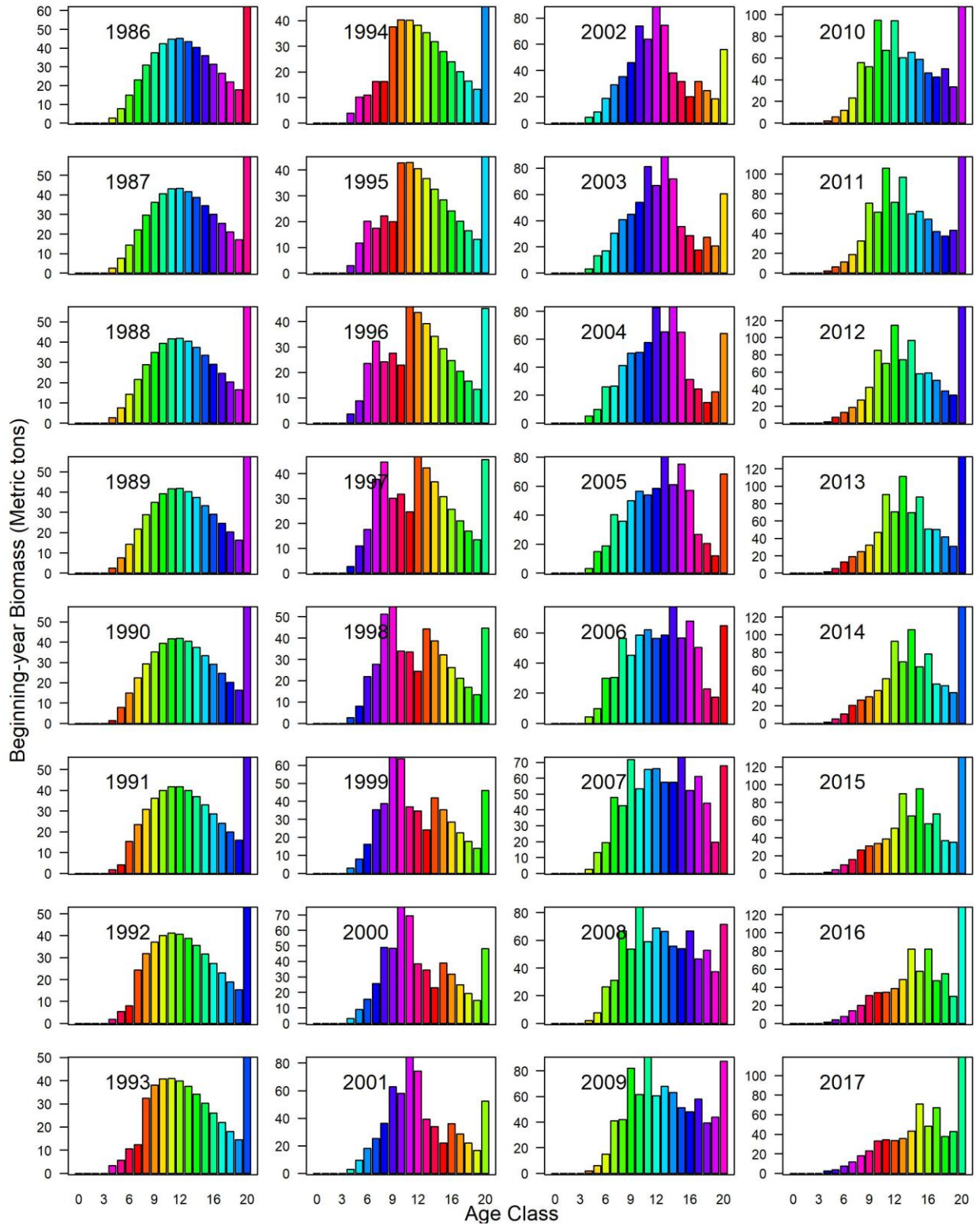

Figure 23E. Expected biomass-at-age (metric tons) at the beginning of each year (January 1st) for male Scamp in the Gulf of Mexico. Note that y-axes differ between panels and colors track cohorts across years.

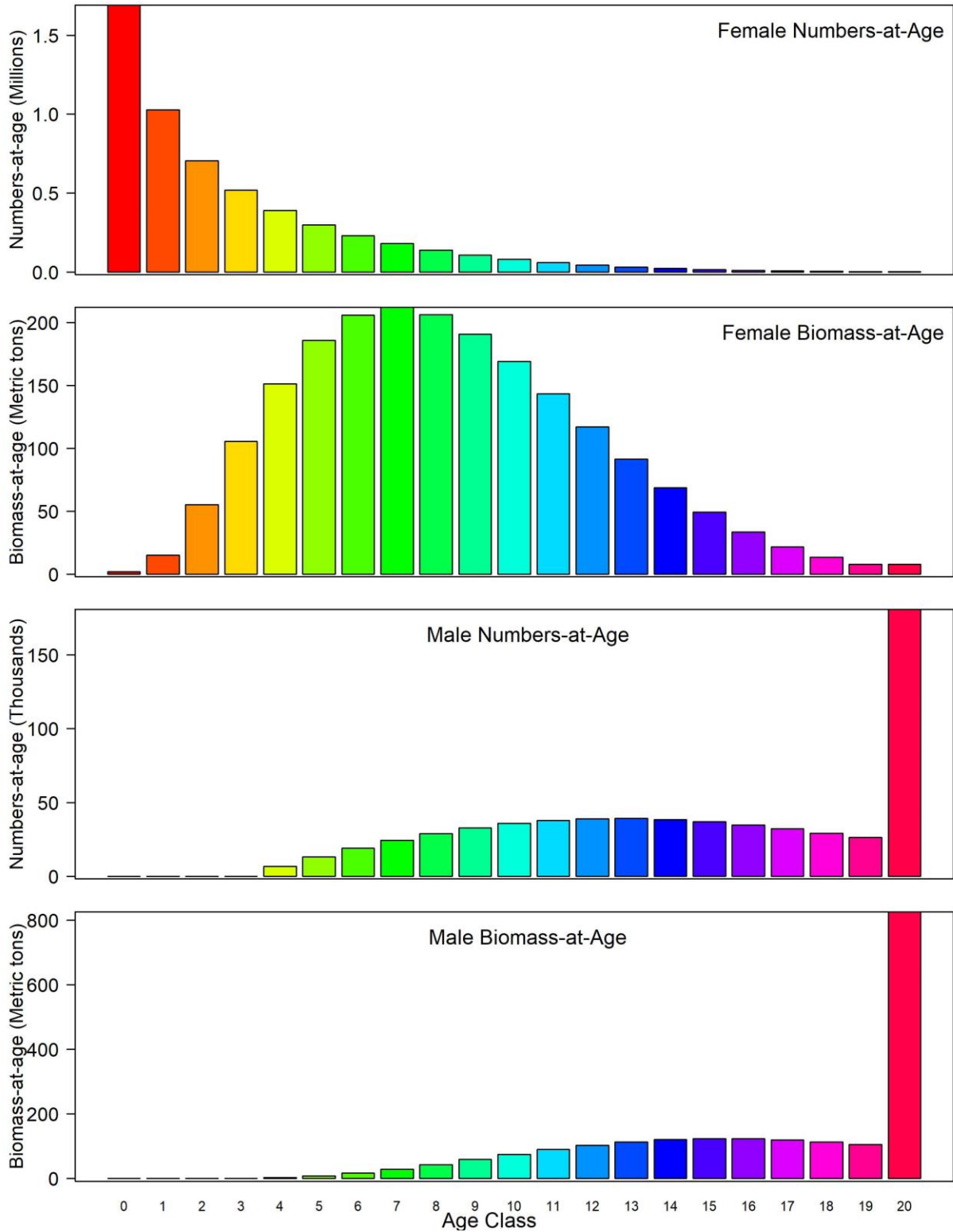

Figure 24. Expected numbers-at-age and biomass-at-age for female and male Scamp in the Gulf of Mexico at virgin stock conditions.

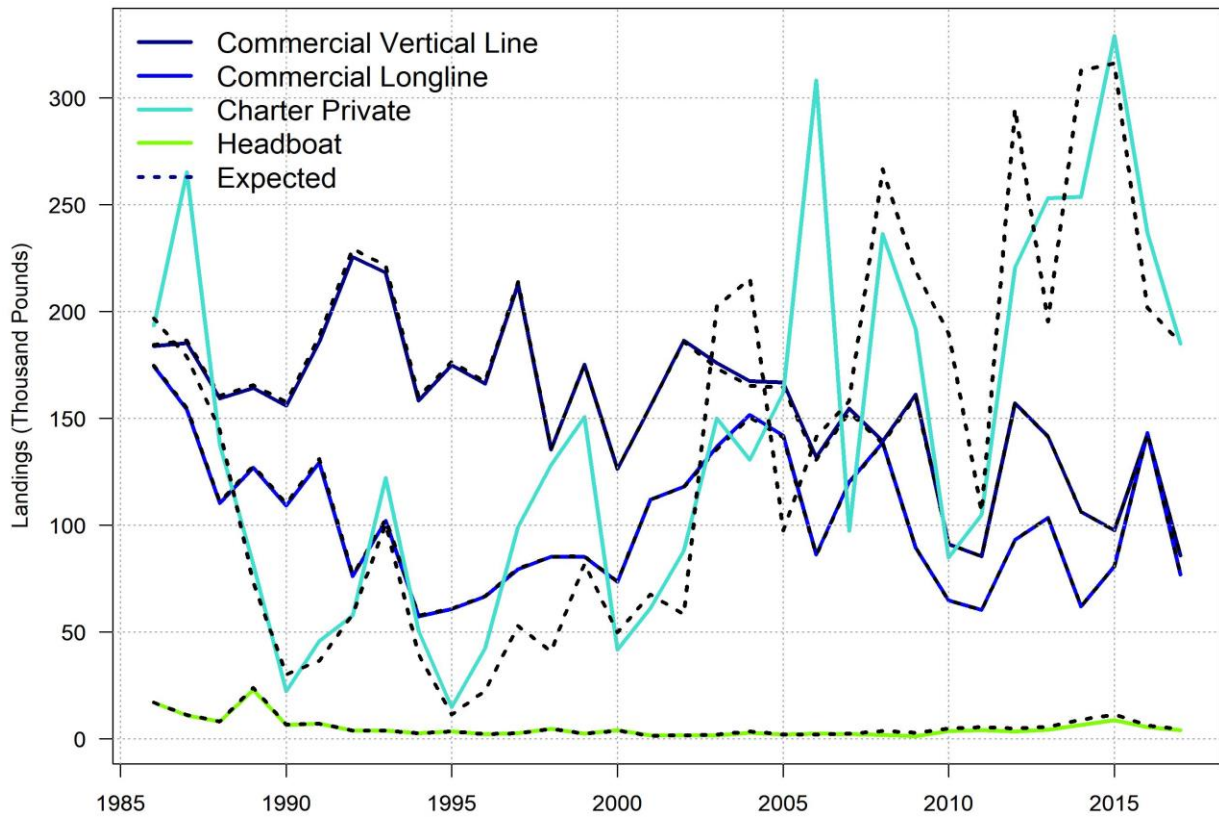

Figure 25. Gulf of Mexico Scamp input (thick colored lines) and expected (dashed lines) landings by fleet. Commercial and recreational landings were input into the model as metric tons in gutted weight, and are shown in thousands of pounds. Associated log-scale standard errors are provided in Tables 16-19.

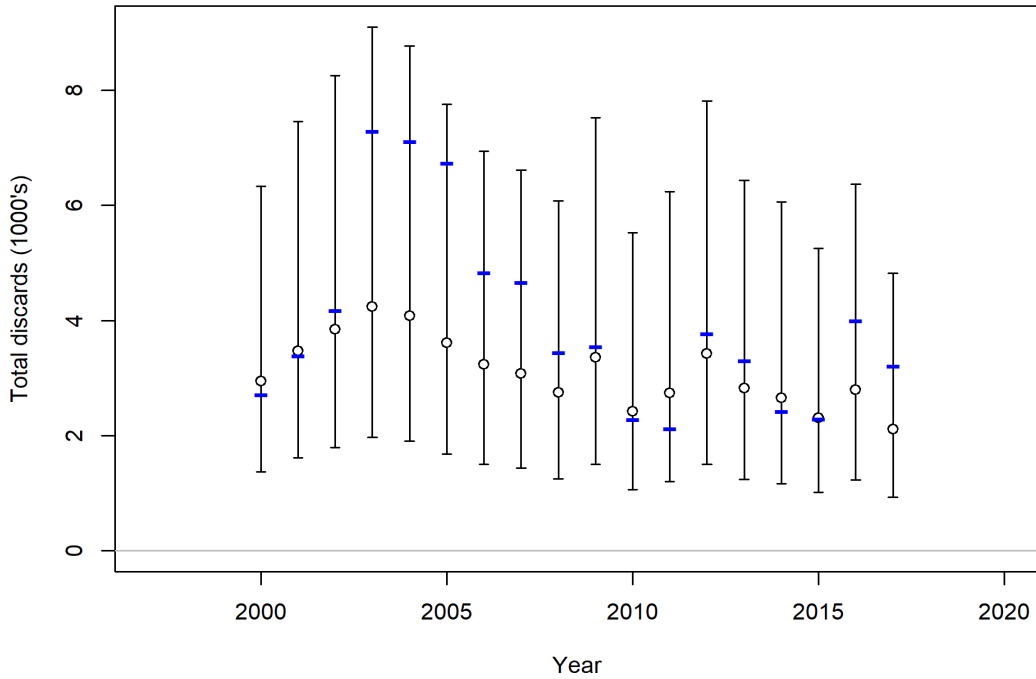

Figure 26A. Input (dots with 95% confidence intervals) and expected (blue lines) discards by the Commercial Vertical Line fleet for Gulf of Mexico Scamp. Discards are in numbers of fish (1,000s) and reflect released fish (i.e., before discard mortality has been applied).

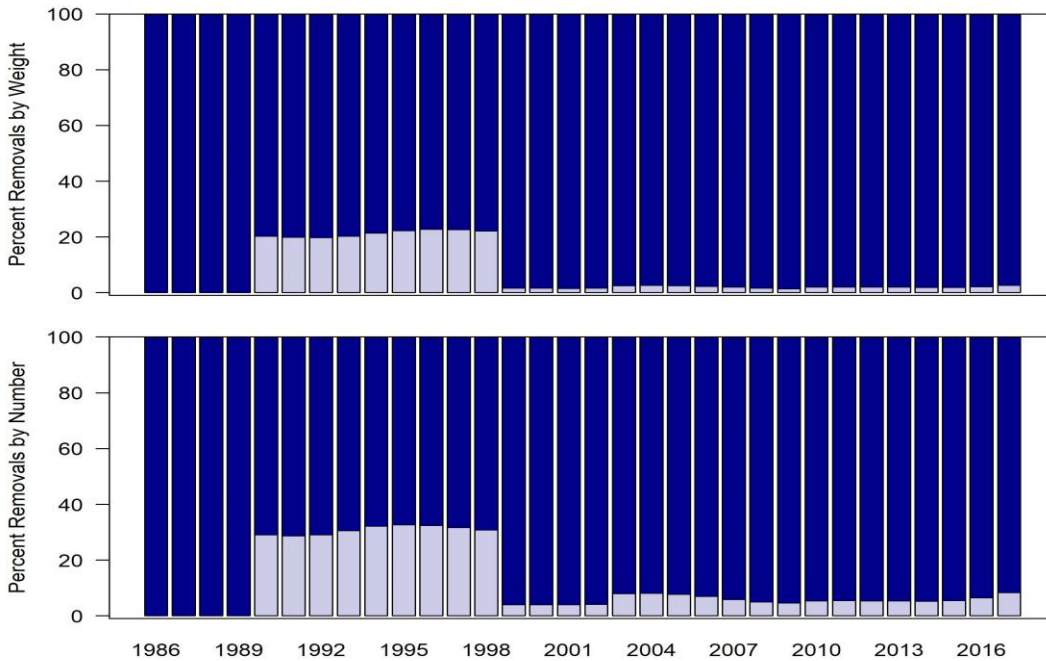

Figure 26B. Comparison of landings (light bars) and dead discards (dark bars) for weights (top panel) and numbers of fish (bottom panel) for the Commercial Vertical Line fleet for Gulf of Mexico Scamp. Estimates of dead discards in both numbers and weights are provided in Table 20.

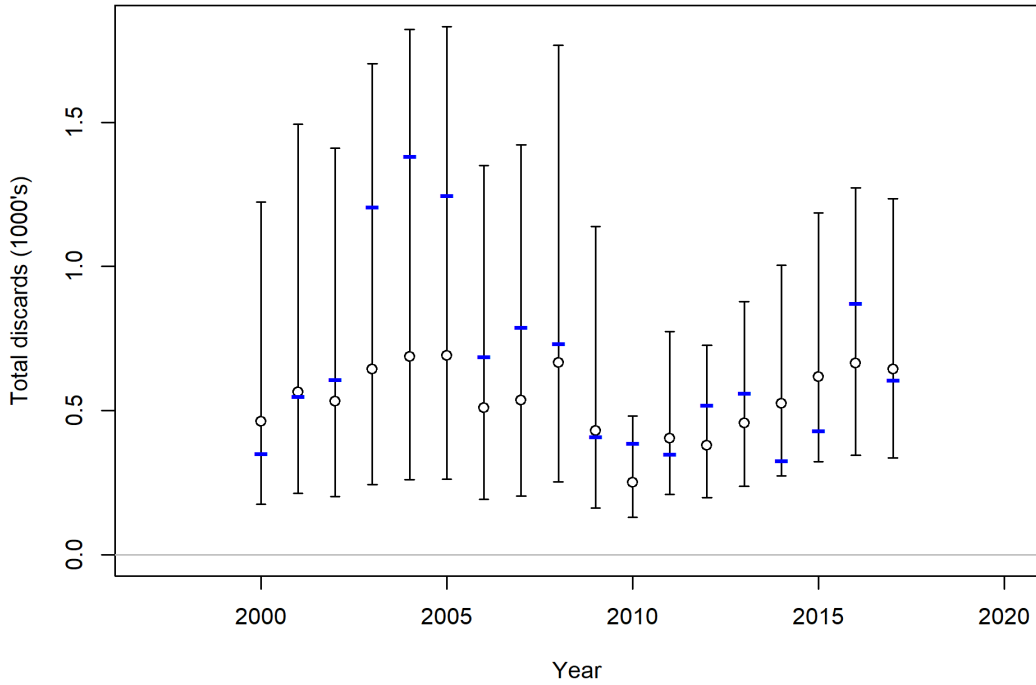

Figure 26C. Input (dots with 95% confidence intervals) and expected (blue lines) discards by the Commercial Longline fleet for Gulf of Mexico Scamp. Discards are in numbers of fish (1,000s) and reflect released fish (i.e., before discard mortality has been applied).

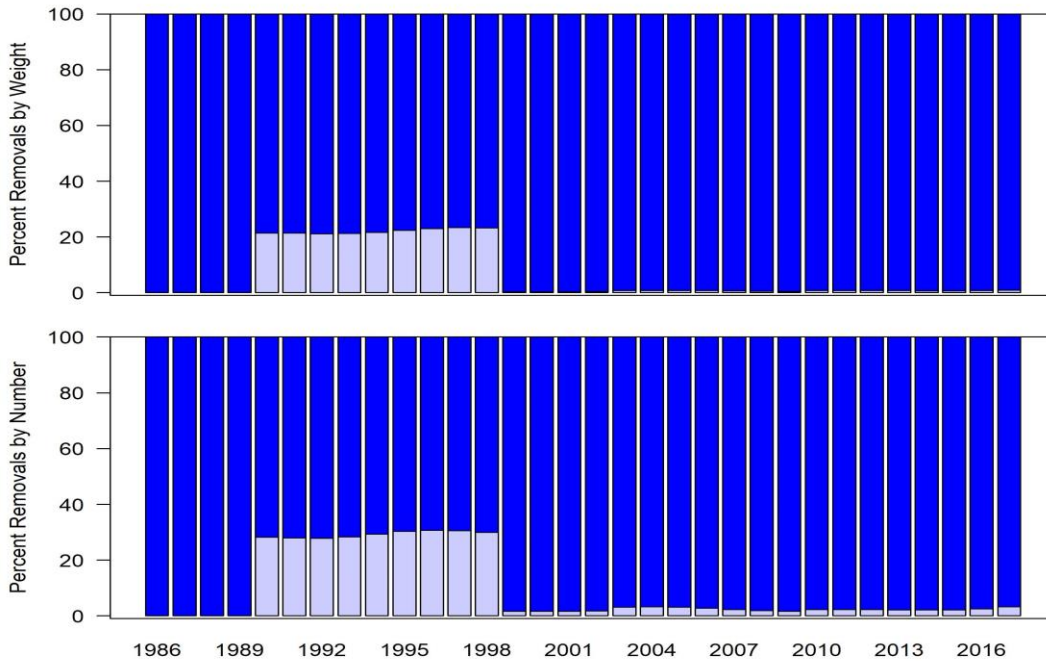

Figure 26D. Comparison of landings (light bars) and dead discards (dark bars) for weights (top panel) and numbers of fish (bottom panel) for the Commercial Longline fleet for Gulf of Mexico Scamp. Estimates of dead discards in both numbers and weights are provided in Table 21.

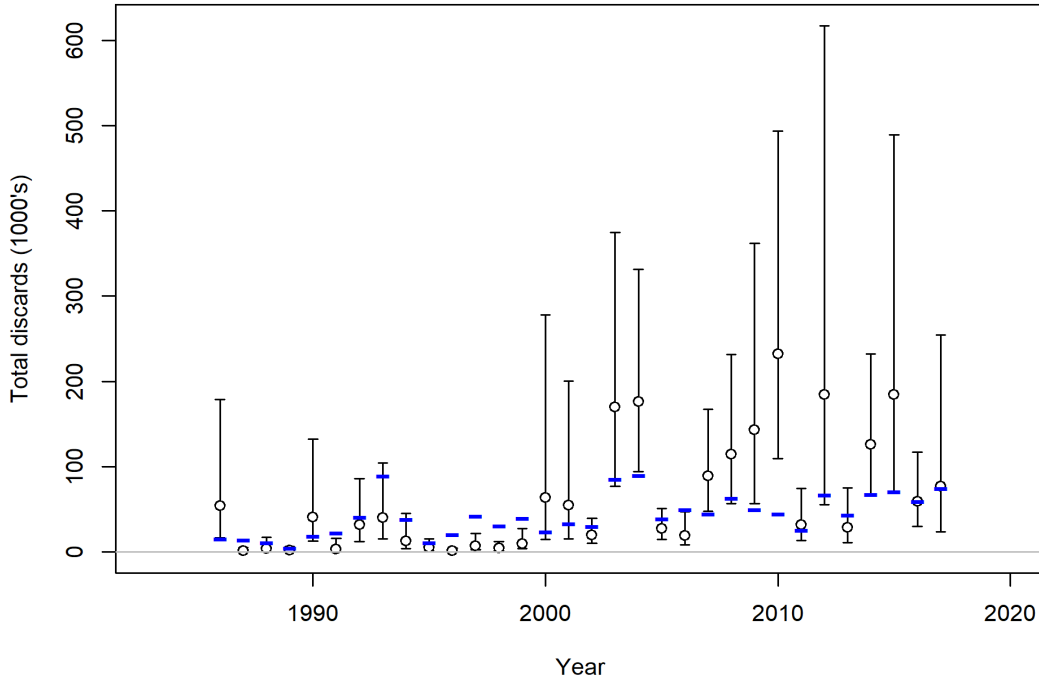

Figure 27A. Input (dots with 95% confidence intervals) and expected (blue lines) discards by the Recreational Charter Private fleet for Gulf of Mexico Scamp. Discards are in numbers of fish (1,000s) and reflect released fish (i.e., before discard mortality has been applied).

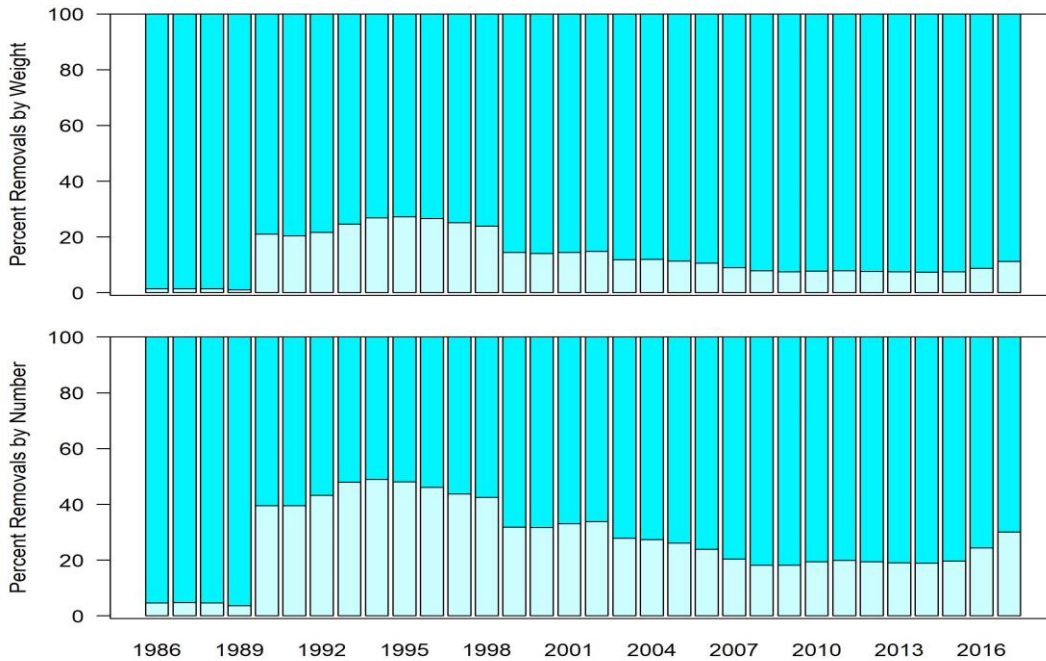

Figure 27B. Comparison of landings (light bars) and dead discards (dark bars) for weights (top panel) and numbers of fish (bottom panel) for the Recreational Charter Private fleet for Gulf of Mexico Scamp. Estimates of dead discards in both numbers and weights are provided in Table 22.

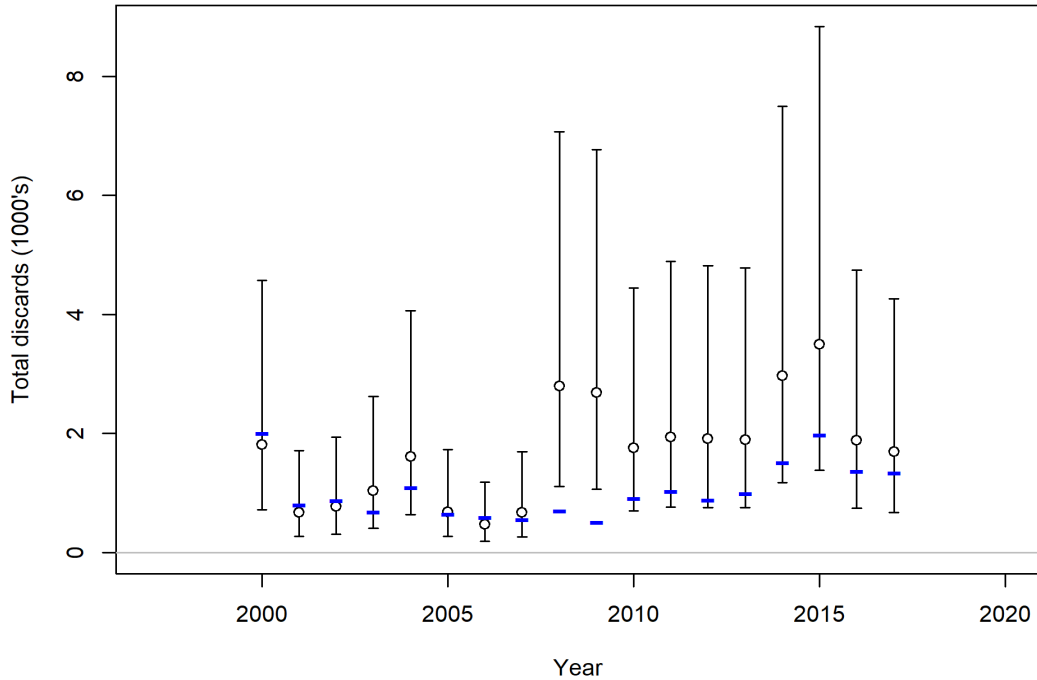

Figure 27C. Input (dots with 95% confidence intervals) and expected (blue lines) discards by the Recreational Headboat fleet for Gulf of Mexico Scamp. Discards are in numbers of fish (1,000s) and reflect released fish (i.e., before discard mortality has been applied).

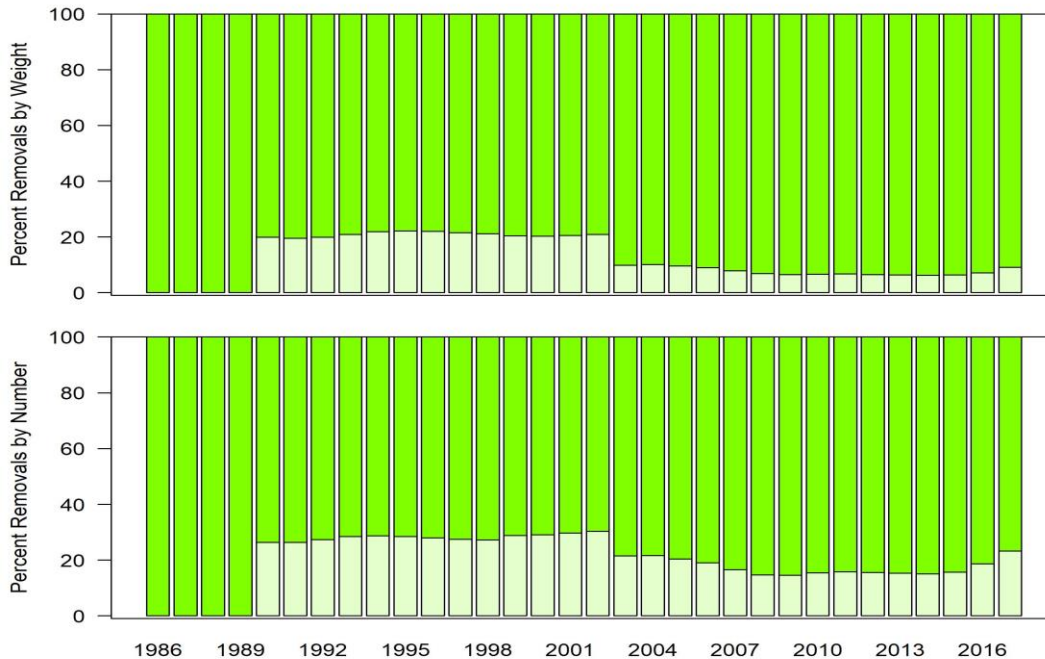

Figure 27D. Comparison of landings (light bars) and dead discards (dark bars) for weights (top panel) and numbers of fish (bottom panel) for the Recreational Headboat fleet for Gulf of Mexico Scamp. Estimates of dead discards in both numbers and weights are provided in Table 23.

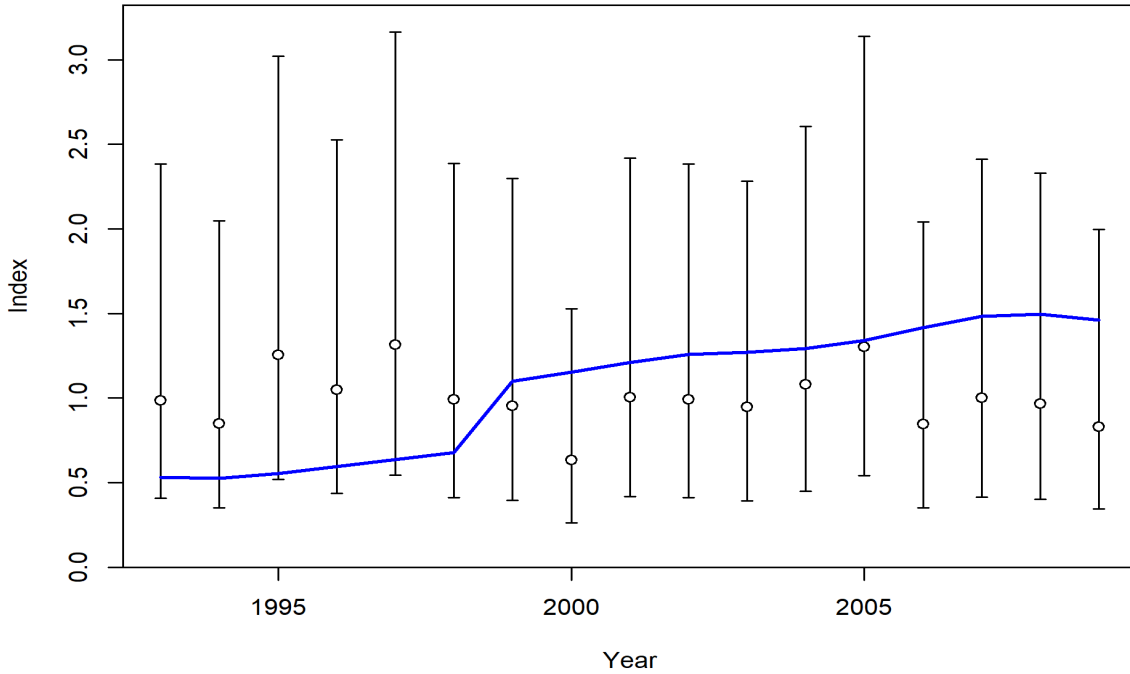

Figure 28A. Input (dots with 95% confidence intervals) and expected (blue lines) indices of relative abundance for Gulf of Mexico Scamp retained by the Commercial Vertical Line fleet prior to the implementation of the Grouper-Tilefish Individual Fishing Quota. A variance adjustment of 0.249 was added to the input SE for each year.

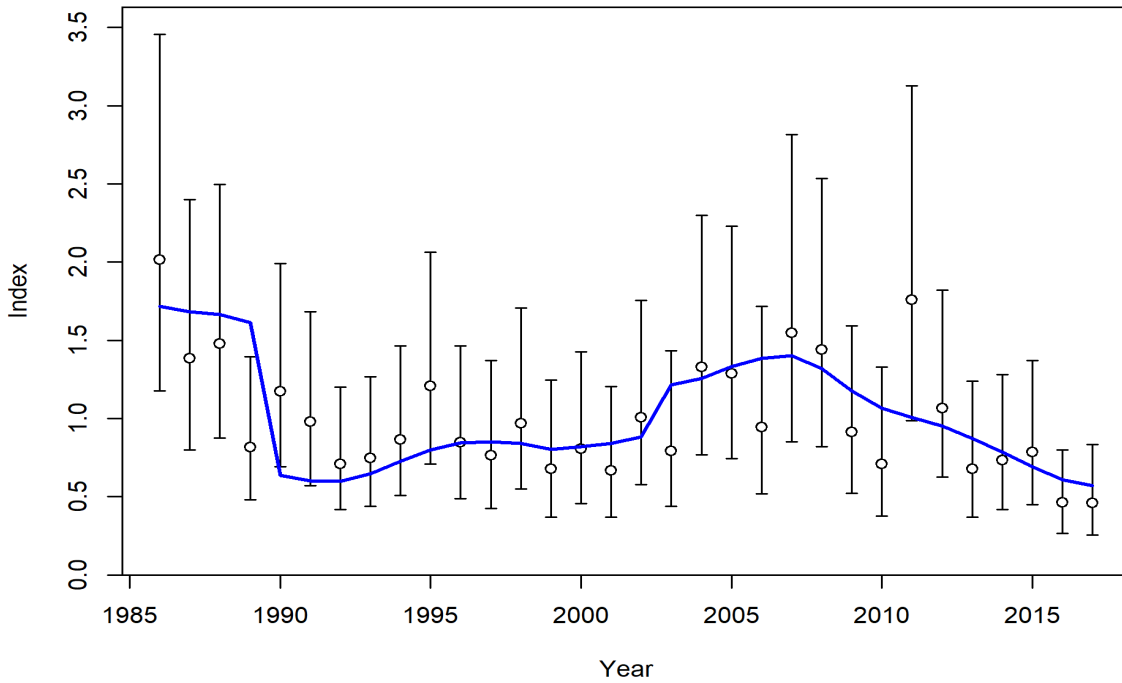

Figure 28B. Input (dots with 95% confidence intervals) and expected (blue lines) indices of relative abundance for Gulf of Mexico Scamp retained by the Recreational Headboat fleet. A variance adjustment of 0.087 was added to the input SE for each year.

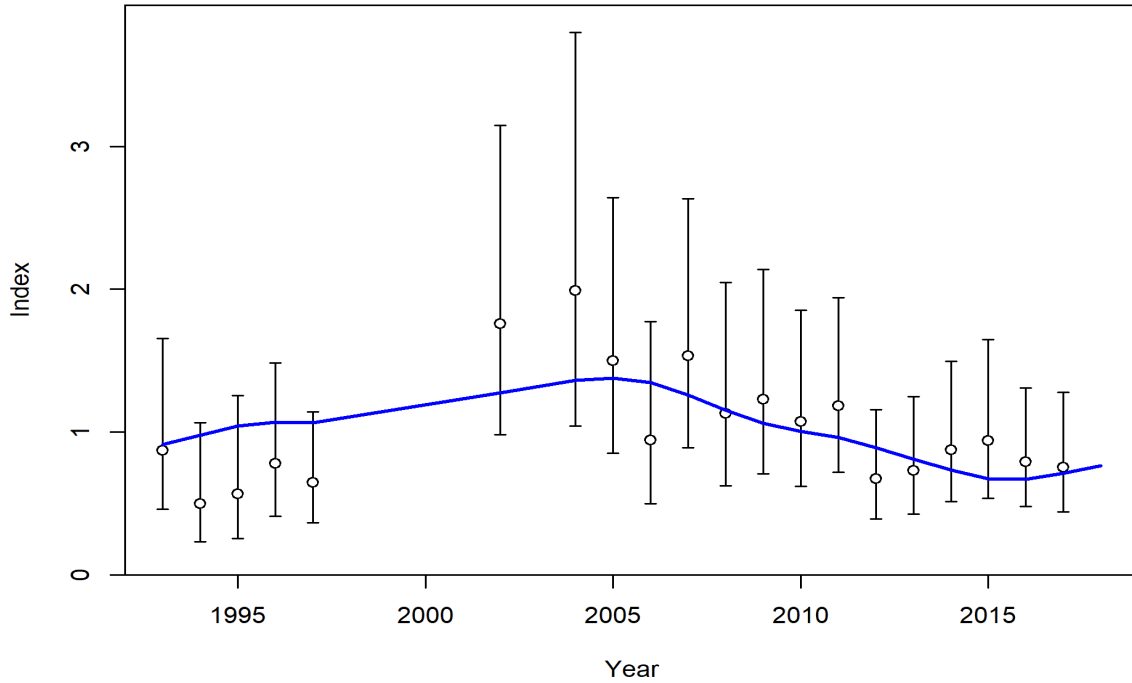

Figure 28C. Input (dots with 95% confidence intervals) and expected (blue lines) indices of relative abundance for Gulf of Mexico Scamp from the Combined Video Survey. A variance adjustment of 0.156 was added to the input SE for each year.

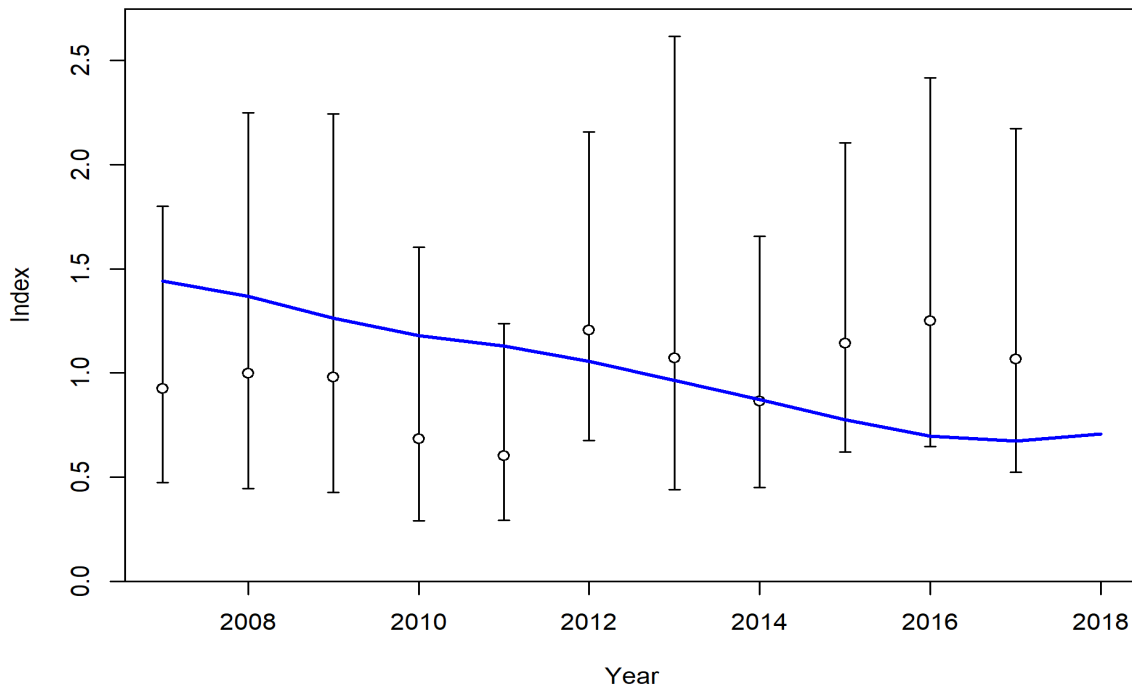

Figure 28D. Input (dots with 95% confidence intervals) and expected (blue lines) indices of relative abundance for Gulf of Mexico Scamp from the RFOP Vertical Line Survey. A variance adjustment of 0.238 was added to the input SE for each year.

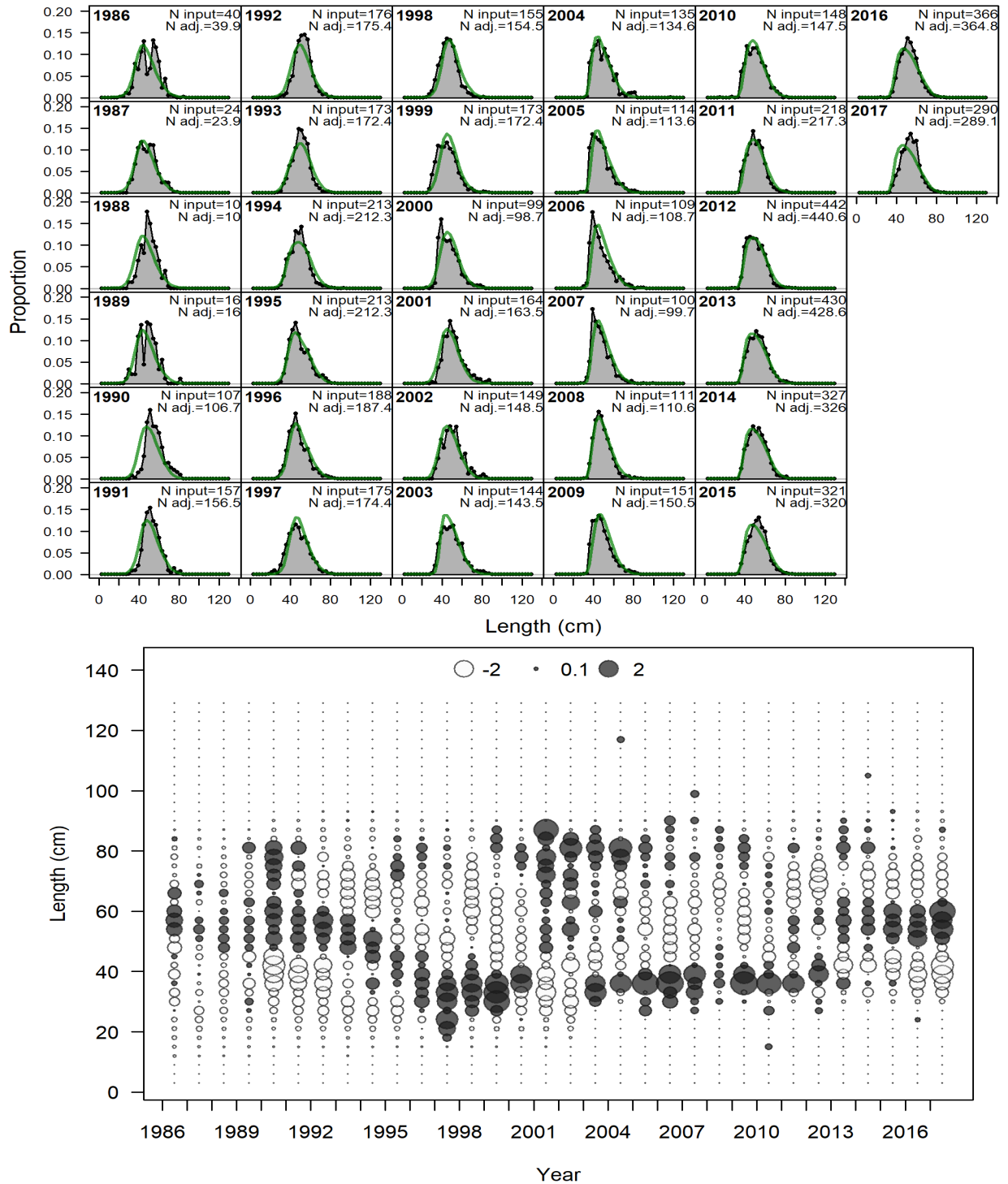

Figure 29A. Observed and expected length compositions and Pearson residuals for Gulf of Mexico Scamp landed by the Commercial Vertical Line fleet. Green lines represent expected length compositions, while grey shaded regions represent observed length compositions. Input sample sizes (N input) and adjusted sample sizes (N adj) estimated by SS are also reported. Closed bubbles are positive residuals ($Obs > Exp$) and open bubbles are negative residuals ($Obs < Exp$).

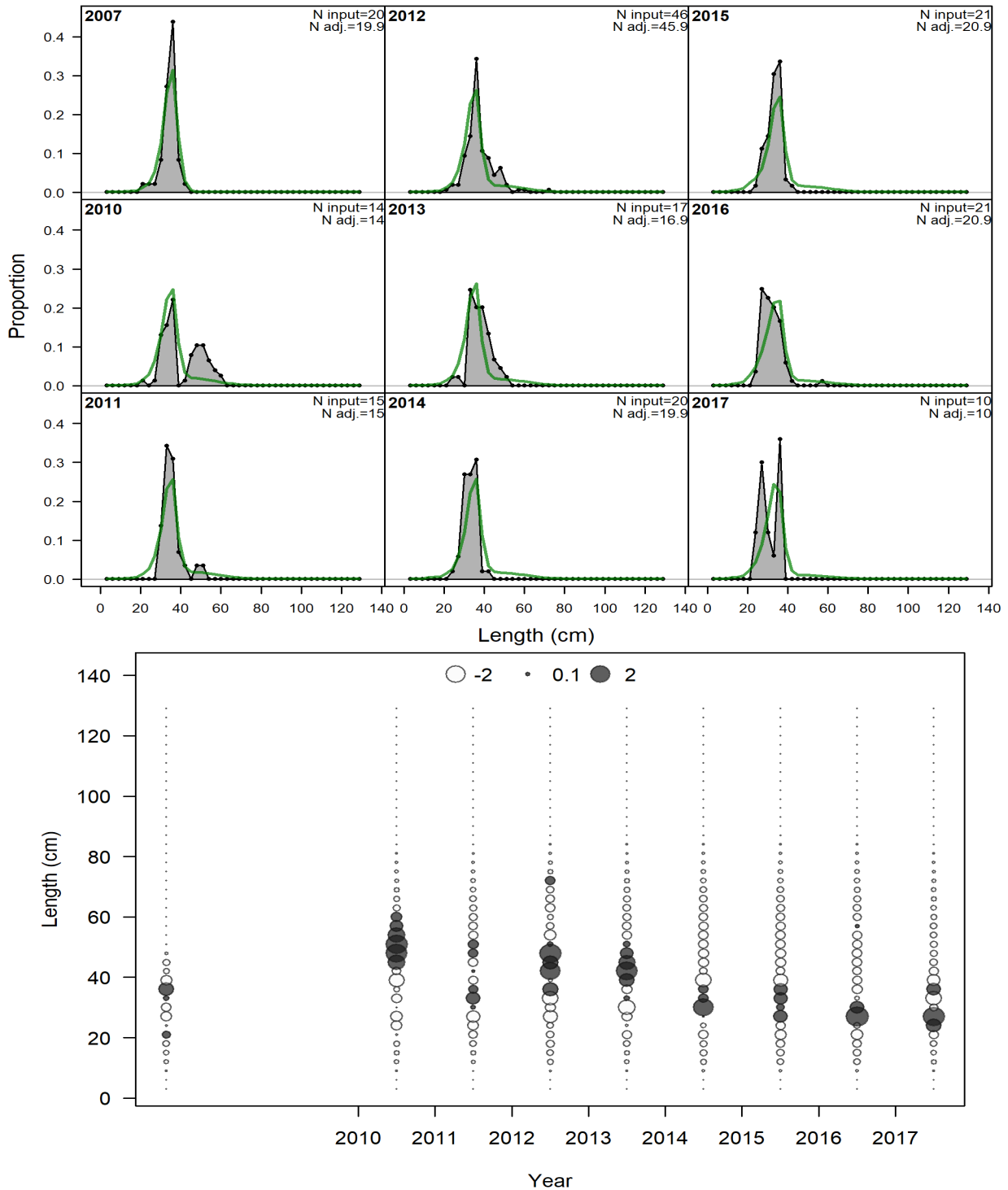

Figure 29B. Observed and expected length compositions and Pearson residuals for Gulf of Mexico Scamp discarded by the Commercial Vertical Line fleet. Green lines represent expected length compositions, while grey shaded regions represent observed length compositions. Input sample sizes (N input) and adjusted sample sizes (N adj.) estimated by SS are also reported. Closed bubbles are positive residuals ($Obs > Exp$) and open bubbles are negative residuals ($Obs < Exp$).

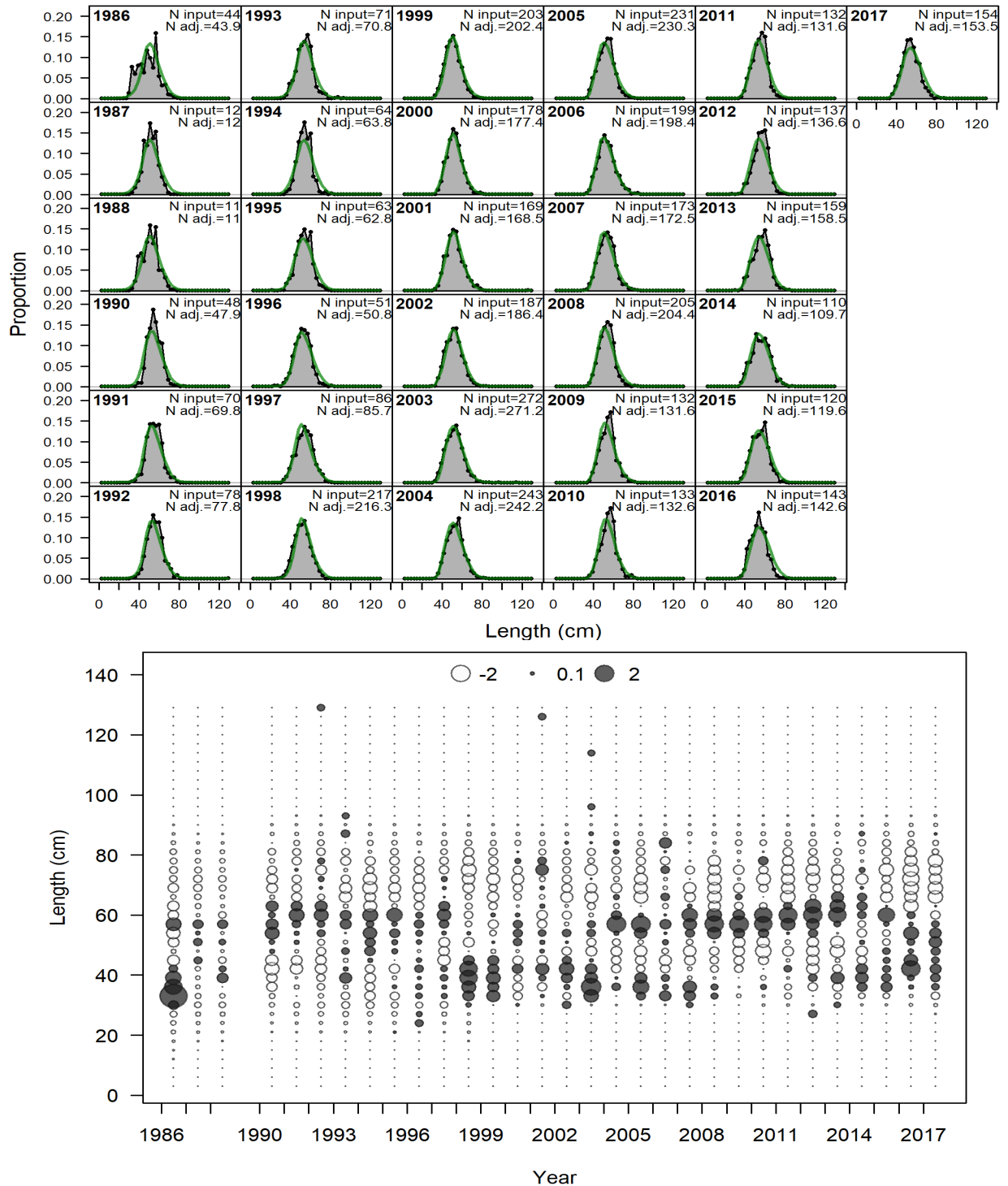

Figure 29C. Observed and expected length compositions and Pearson residuals for Gulf of Mexico Scamp landed by the Commercial Longline fleet. Green lines represent expected length compositions, while grey shaded regions represent observed length compositions. Input sample sizes (N_{input}) and adjusted sample sizes (N_{adj}) estimated by SS are also reported. Closed bubbles are positive residuals ($Obs > Exp$) and open bubbles are negative residuals ($Obs < Exp$).

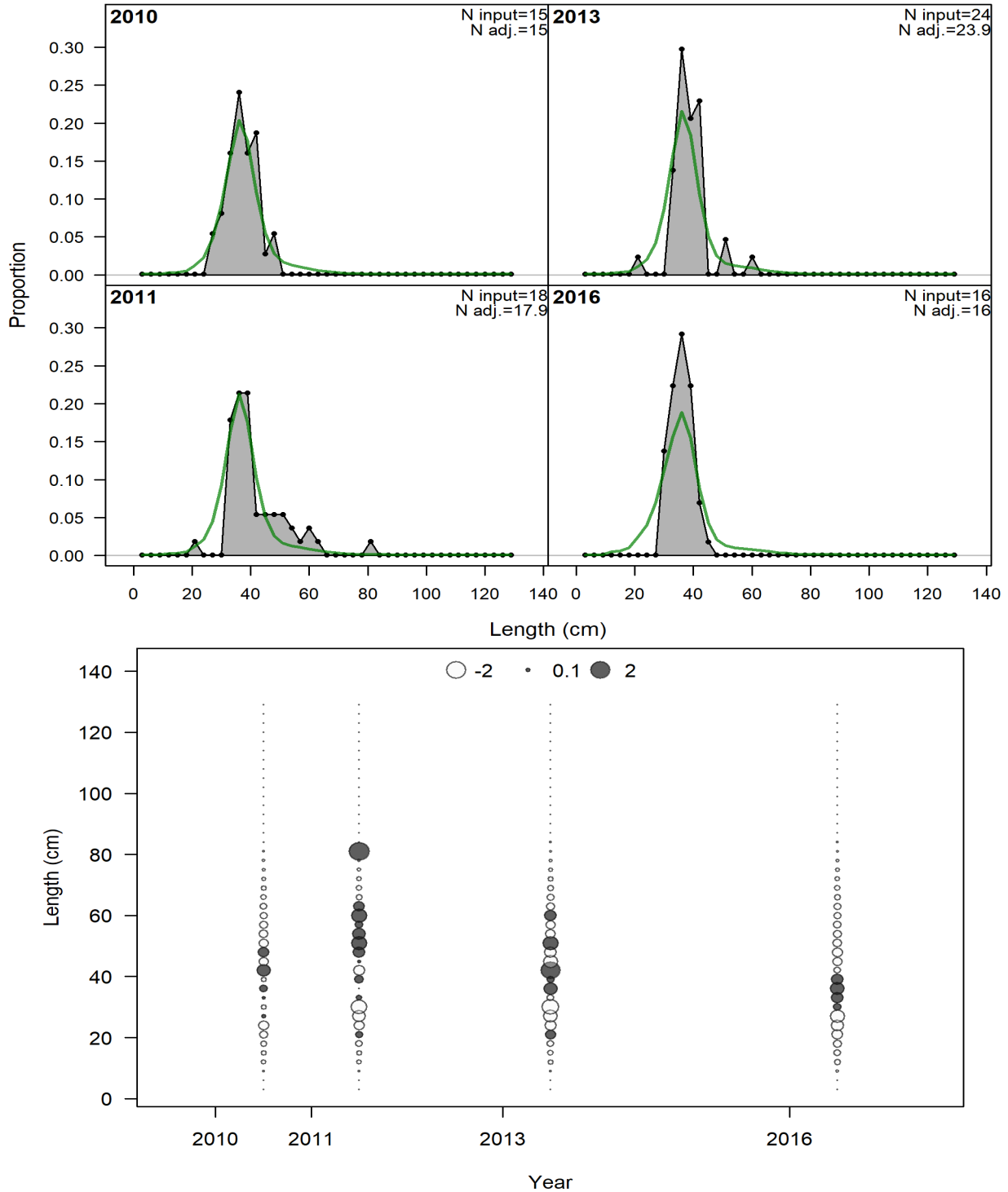

Figure 29D. Observed and expected length compositions and Pearson residuals for Gulf of Mexico Scamp discarded by the Commercial Longline fleet. Green lines represent expected length compositions, while grey shaded regions represent observed length compositions. Input sample sizes (N_{input}) and adjusted sample sizes (N_{adj}) estimated by SS are also reported. Closed bubbles are positive residuals ($Obs > Exp$) and open bubbles are negative residuals ($Obs < Exp$).

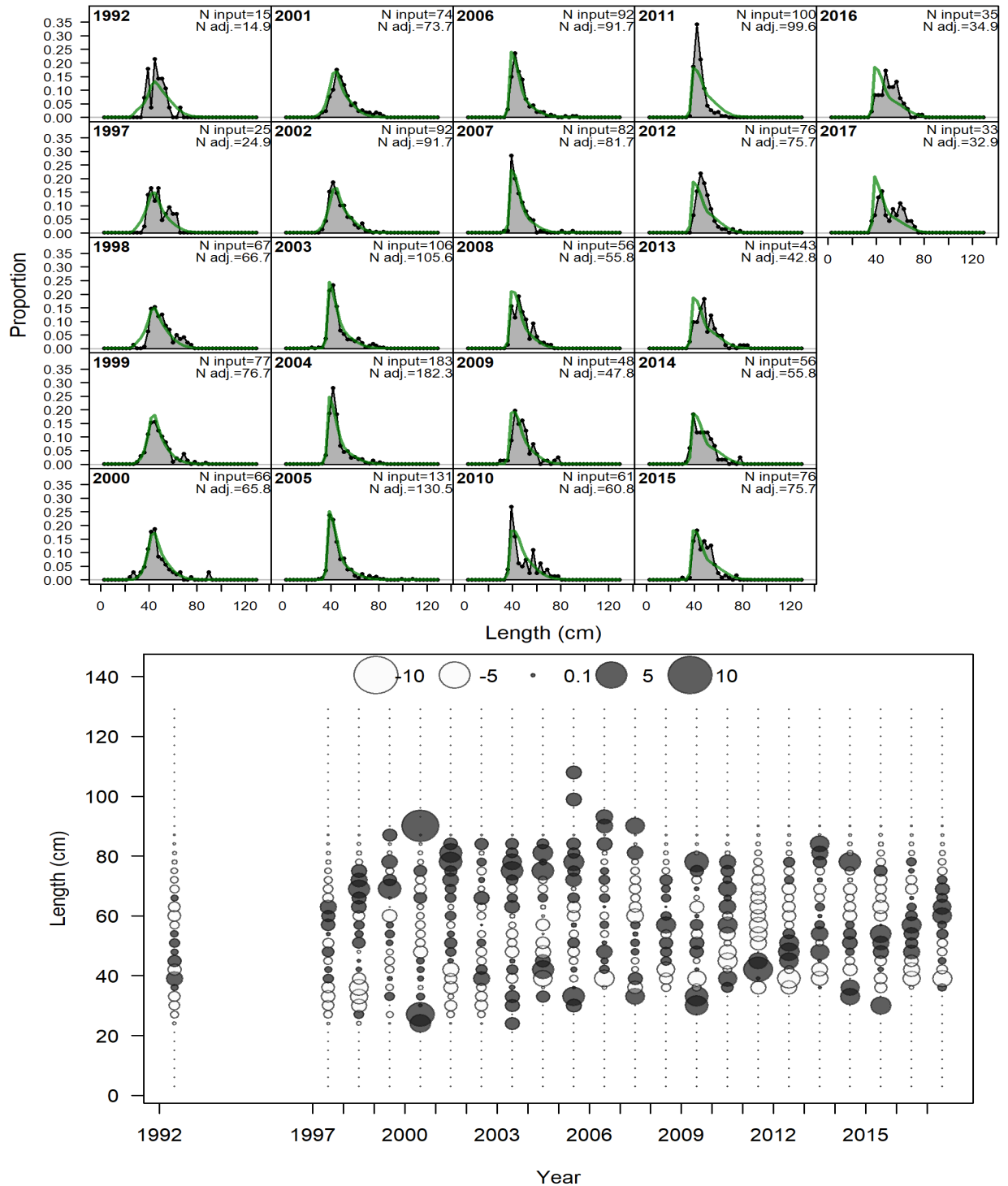

Figure 30A. Observed and expected length compositions and Pearson residuals for Gulf of Mexico Scamp landed by the Recreational Charter Private fleet. Green lines represent expected length compositions, while grey shaded regions represent observed length compositions. Input sample sizes (N input) and adjusted sample sizes (N adj.) estimated by SS are also reported. Closed bubbles are positive residuals ($Obs > Exp$) and open bubbles are negative residuals ($Obs < Exp$).

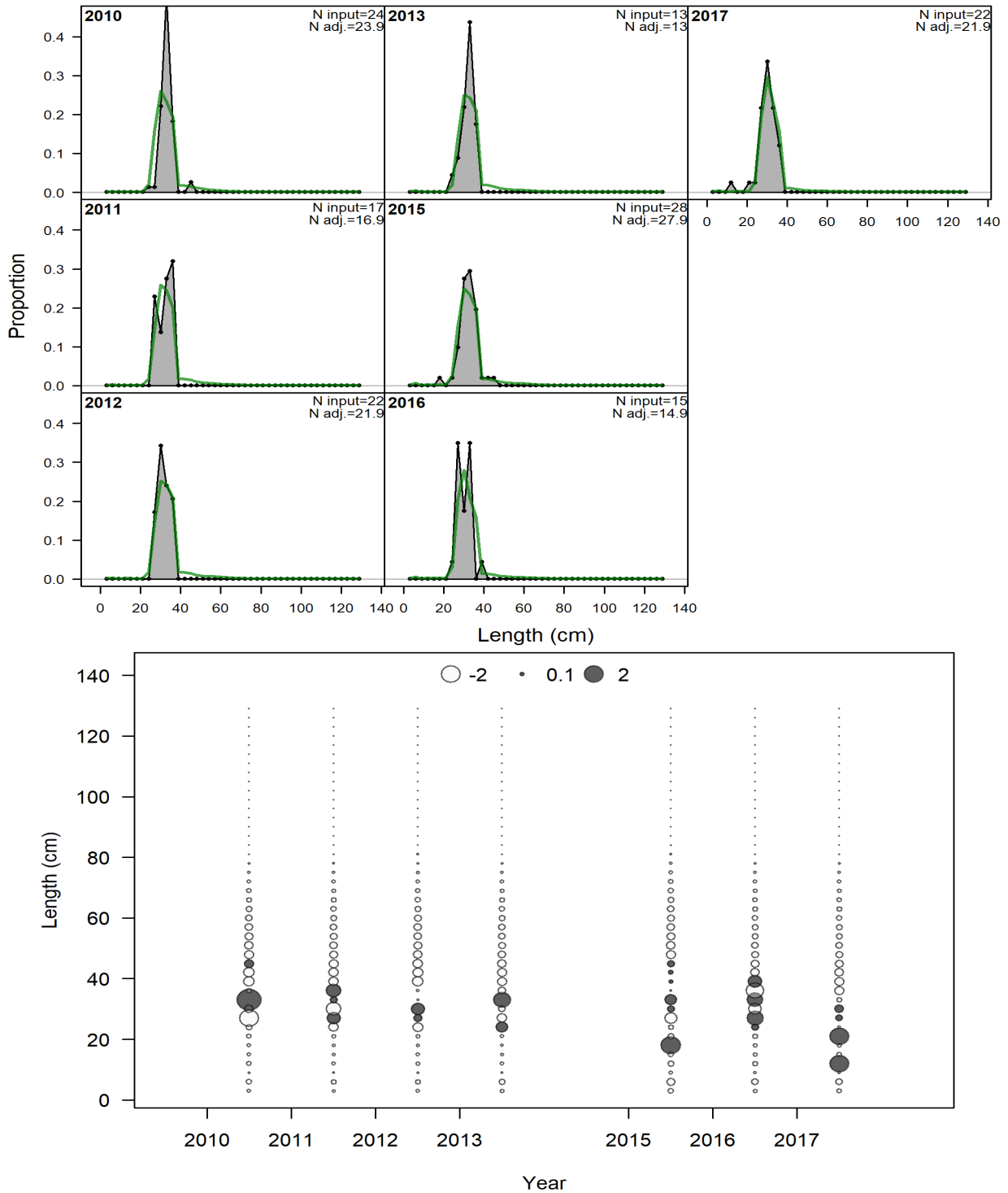

Figure 30B. Observed and expected length compositions and Pearson residuals for Gulf of Mexico Scamp discarded by the Recreational Charter Private fleet. Green lines represent expected length compositions, while grey shaded regions represent observed length compositions. Input sample sizes (N input) and adjusted sample sizes (N adj.) estimated by SS are also reported. Closed bubbles are positive residuals ($Obs > Exp$) and open bubbles are negative residuals ($Obs < Exp$).

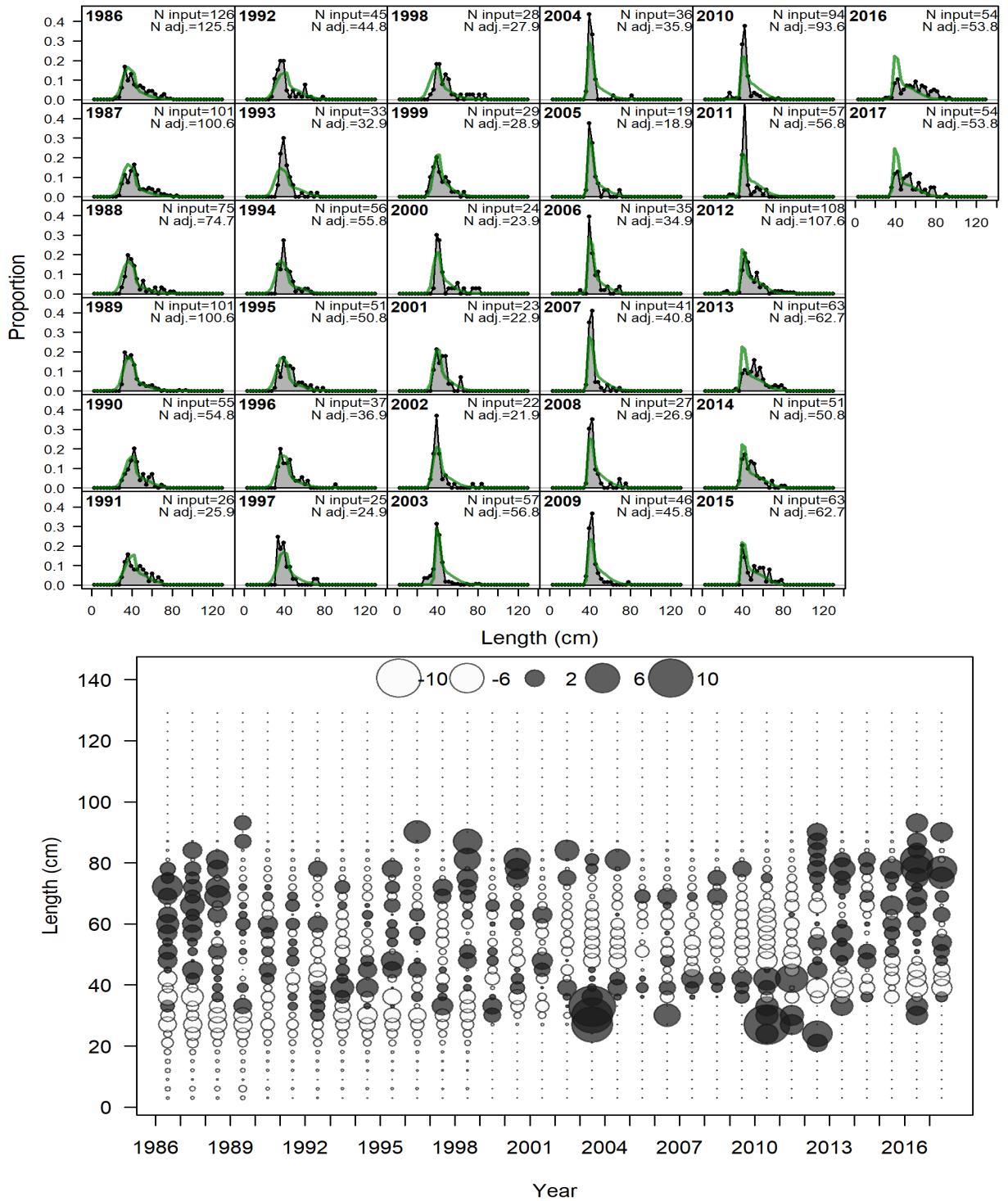

Figure 30C. Observed and expected length compositions and Pearson residuals for Gulf of Mexico Scamp landed by the Recreational Headboat fleet. Green lines represent expected length compositions, while grey shaded regions represent observed length compositions. Input sample sizes (N input) and adjusted sample sizes (N adj) estimated by SS are also reported. Closed bubbles are positive residuals ($Obs > Exp$) and open bubbles are negative residuals ($Obs < Exp$).

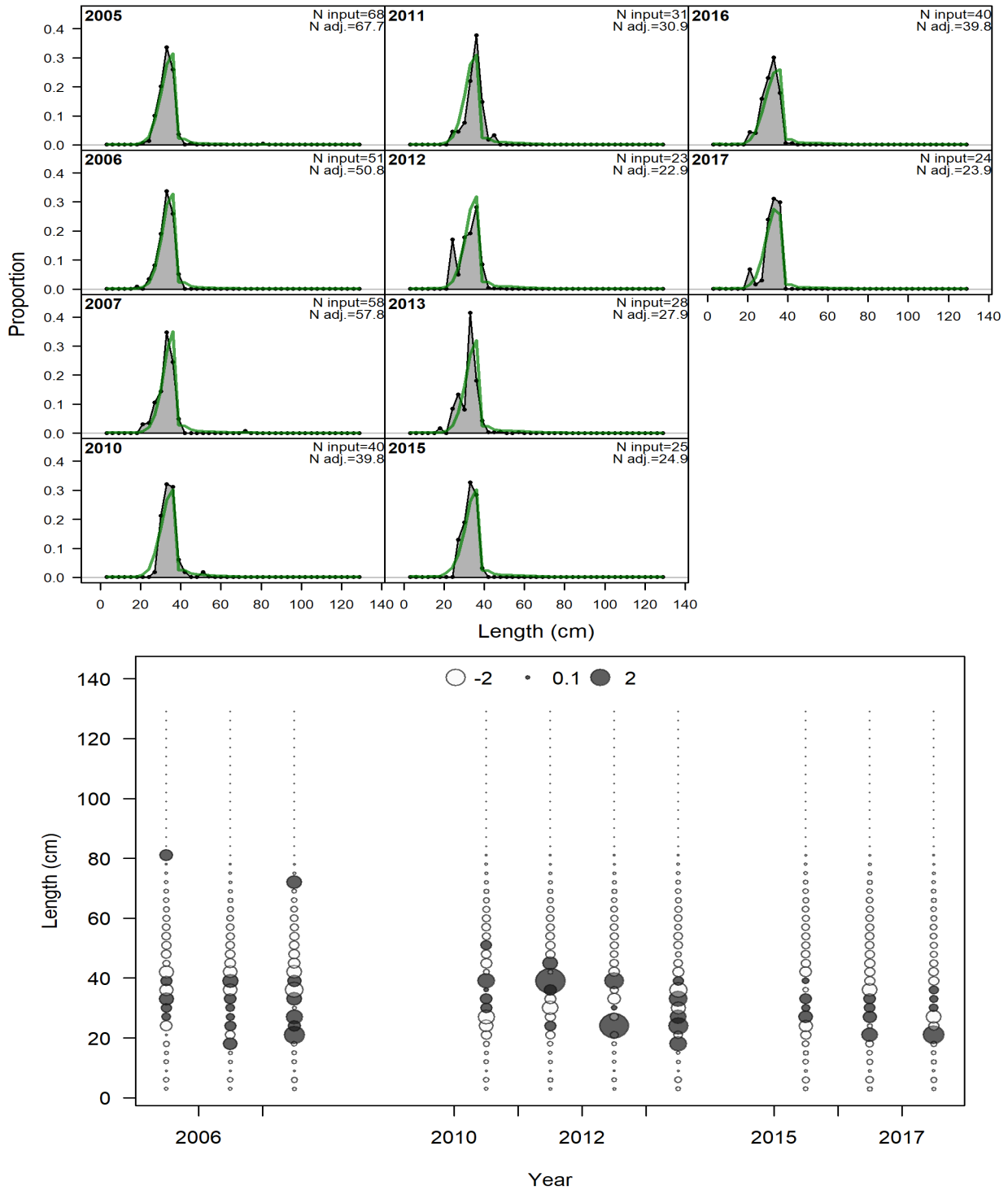

Figure 30D. Observed and expected length compositions and Pearson residuals for Gulf of Mexico Scamp discarded by the Recreational Headboat fleet. Green lines represent expected length compositions, while grey shaded regions represent observed length compositions. Input sample sizes (N input) and adjusted sample sizes (N adj.) estimated by SS are also reported. Closed bubbles are positive residuals ($Obs > Exp$) and open bubbles are negative residuals ($Obs < Exp$).

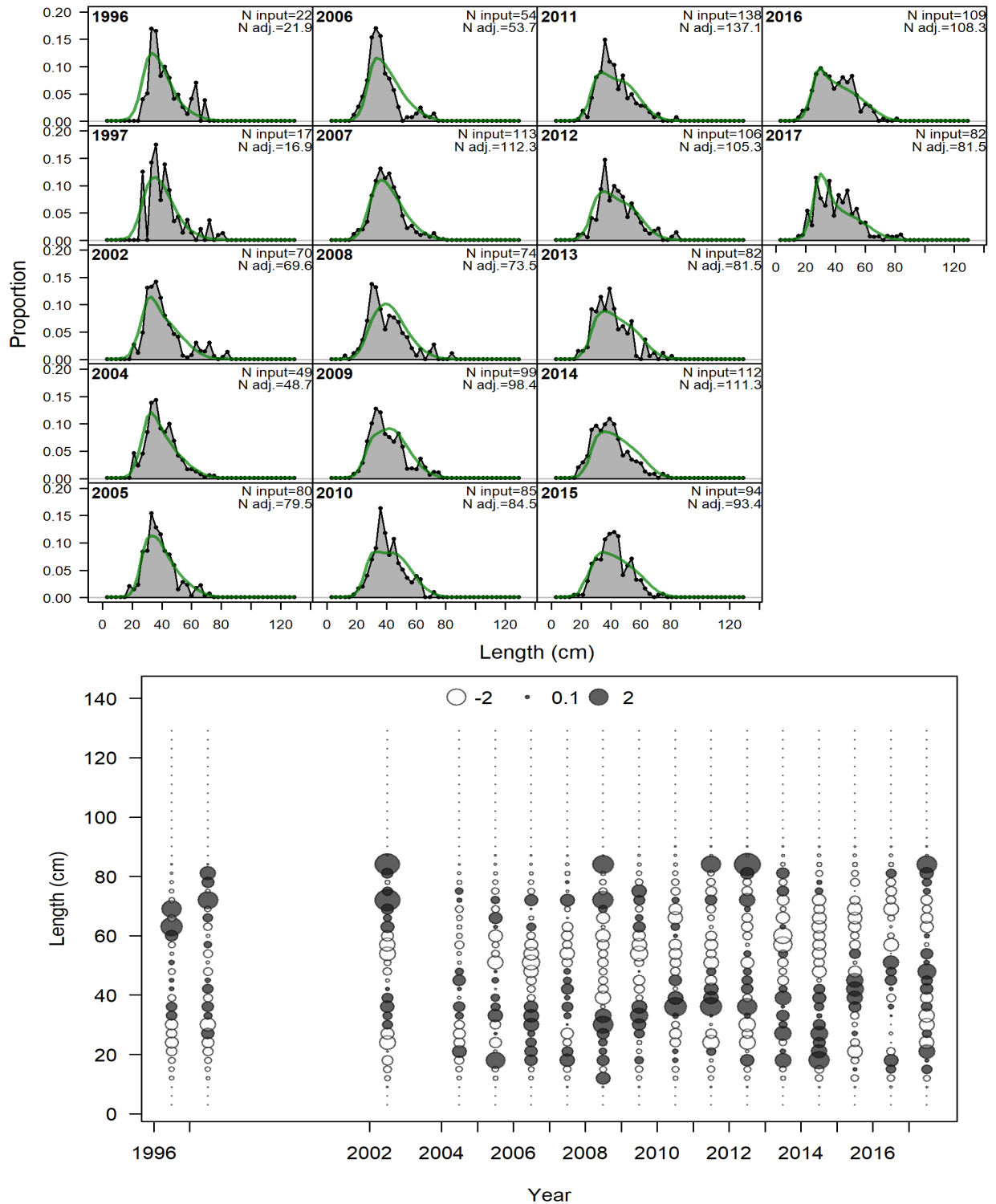

Figure 31. Observed and expected length compositions and Pearson residuals for Gulf of Mexico Scamp in the Combined Video Survey. Green lines represent expected length compositions, while grey shaded regions represent observed length compositions. Input sample sizes (N input) and adjusted sample sizes (N adj.) estimated by SS are also reported. Closed bubbles are positive residuals (Obs > Exp) and open bubbles are negative residuals (Obs < Exp).

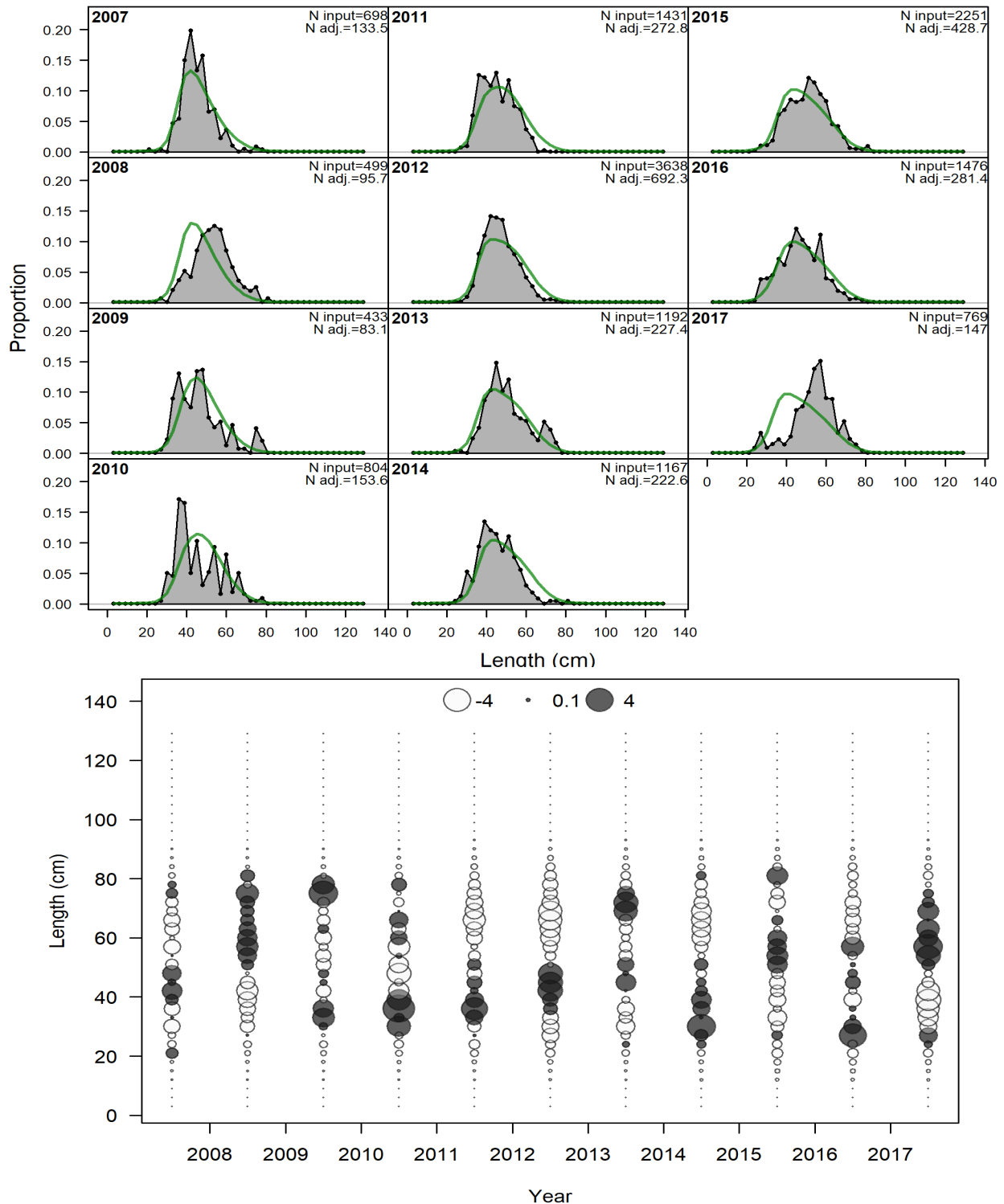

Figure 32. Observed and expected length compositions and Pearson residuals for Gulf of Mexico Scamp in the RFOP Vertical Line Survey. Green lines represent expected length compositions, while grey shaded regions represent observed length compositions. Input sample sizes (N_{input}) and adjusted sample sizes (N_{adj}) estimated by SS are also reported. Closed bubbles are positive residuals ($Obs > Exp$) and open bubbles are negative residuals ($Obs < Exp$).

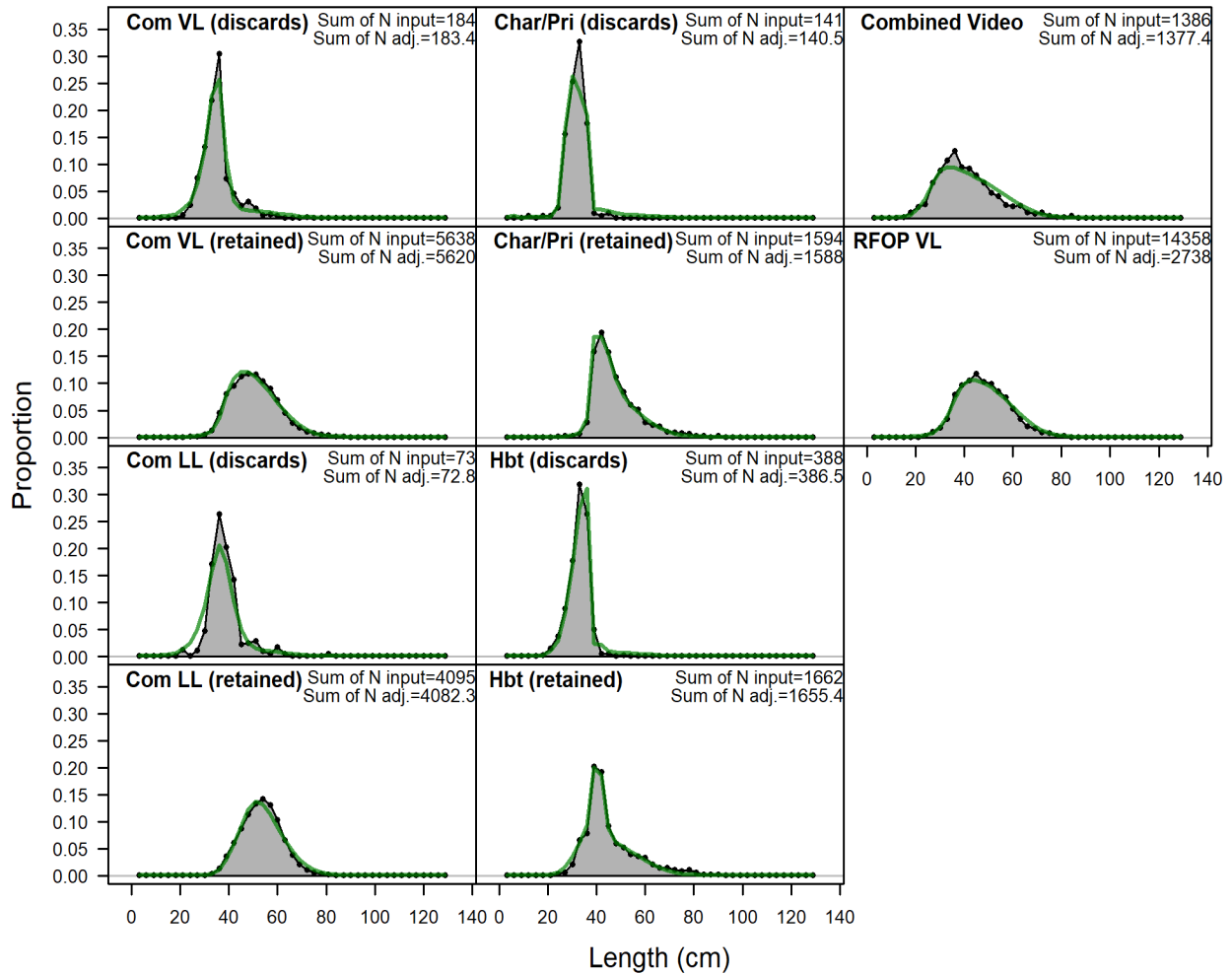

Figure 33. Model fits to the length composition of discarded or landed (i.e., retained) catch aggregated across years within a given fleet or survey for Gulf of Mexico Scamp. Green lines represent expected length compositions, while grey shaded regions represent observed length compositions. The input (N_{input}) and adjusted (N_{adj}) sample sizes are provided in the upper right corner of each panel. Abbreviations include: Commercial Vertical Line (Com VL), Commercial Longline (Com LL), Recreational Charter Private (Char/Pri), Recreational Headboat (Hbt), and Reef Fish Observer Program Vertical Line (RFOP VL).

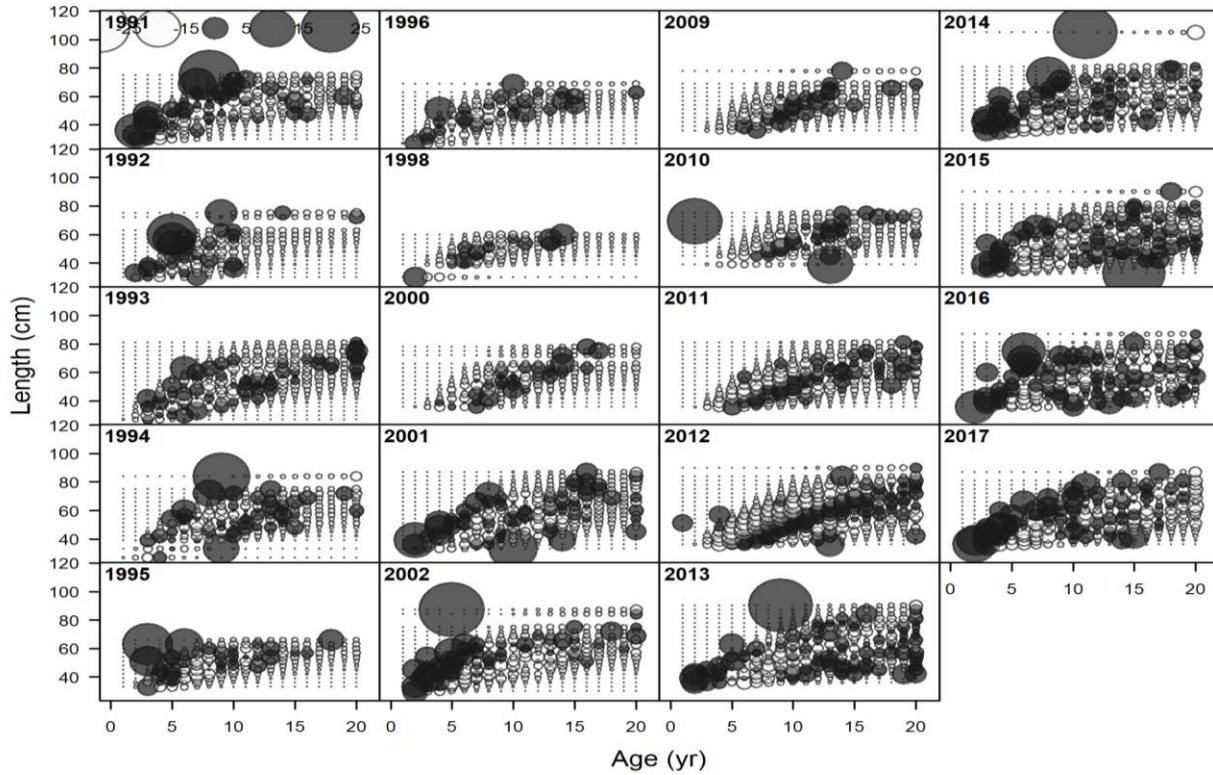

Figure 34A. Observed and expected conditional age-at-length compositions for Gulf of Mexico Scamp landed by the Commercial Vertical Line fleet.

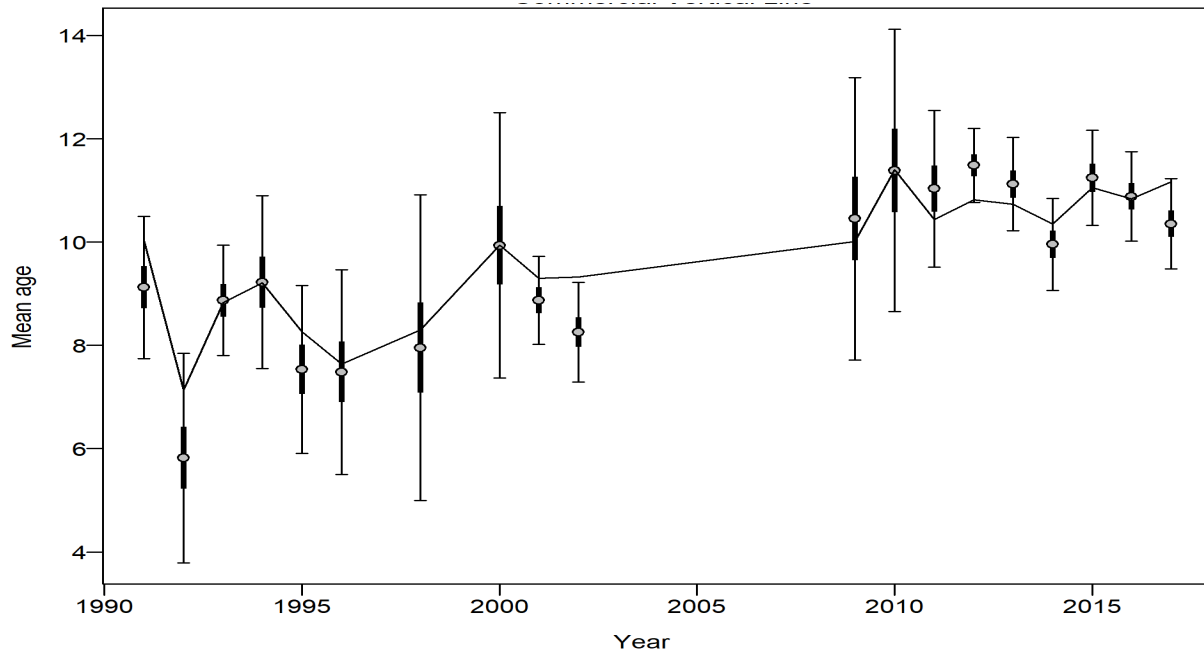

Figure 34B. Mean age of landed Gulf of Mexico Scamp from conditional data (aggregated across length bins) by the Commercial Vertical Line fleet with 95% confidence intervals (thick bars). Thinner intervals (with capped ends) show the result of further adjusting sample sizes based on the Francis data weighting method, which was not used here.

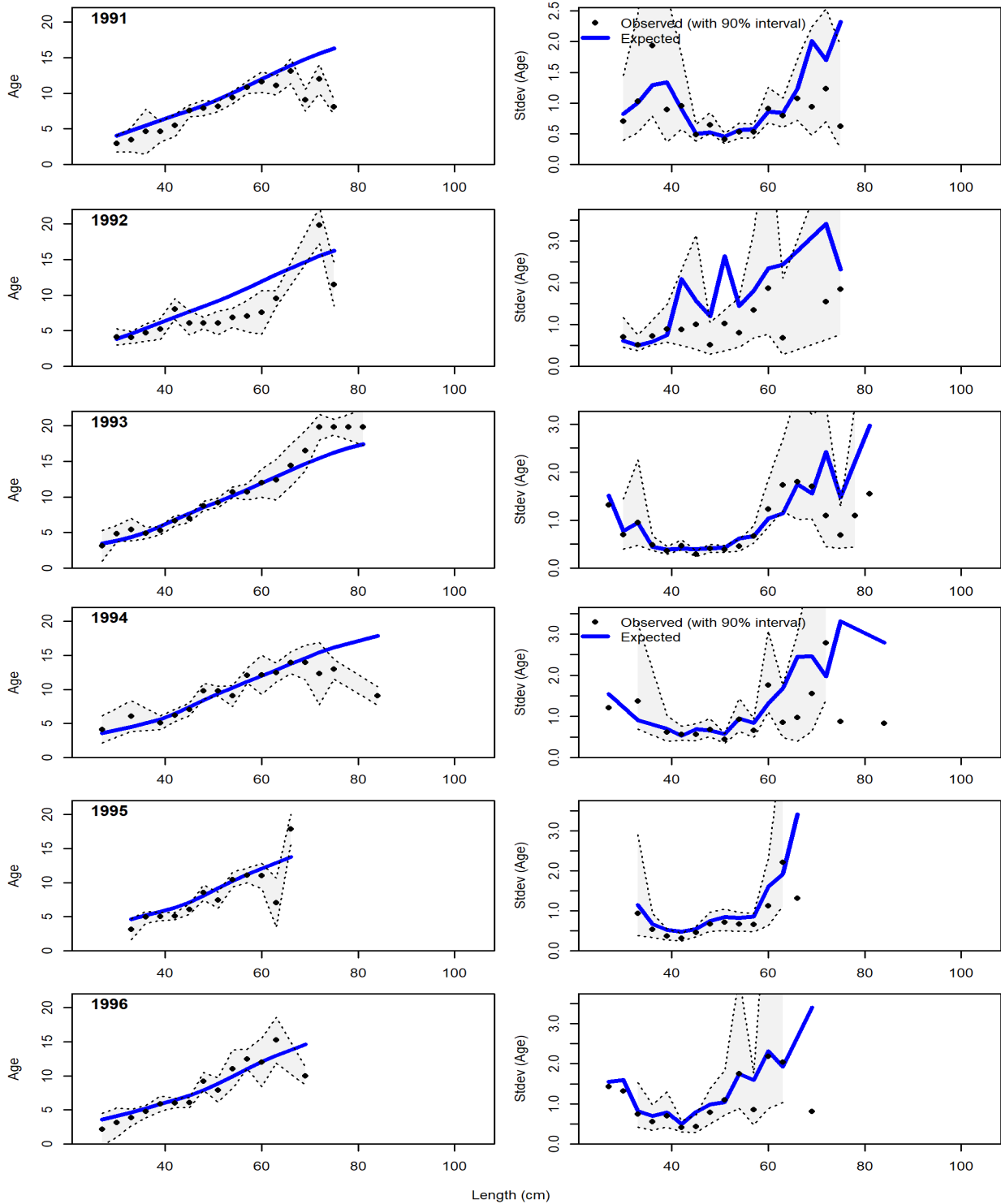

Figure 34C. Conditional age composition fits for Gulf of Mexico Scamp landed by the Commercial Vertical Line fleet. Left panels are estimated mean age-at-length (observed and expected) at 3 cm FL bins with 90% Confidence Intervals based on adding 1.64 SE of mean to the data. Right panels are the estimated SD of mean age-at-length (observed and expected) at 3 cm FL bins with 90% confidence intervals based on the chi-square distribution.

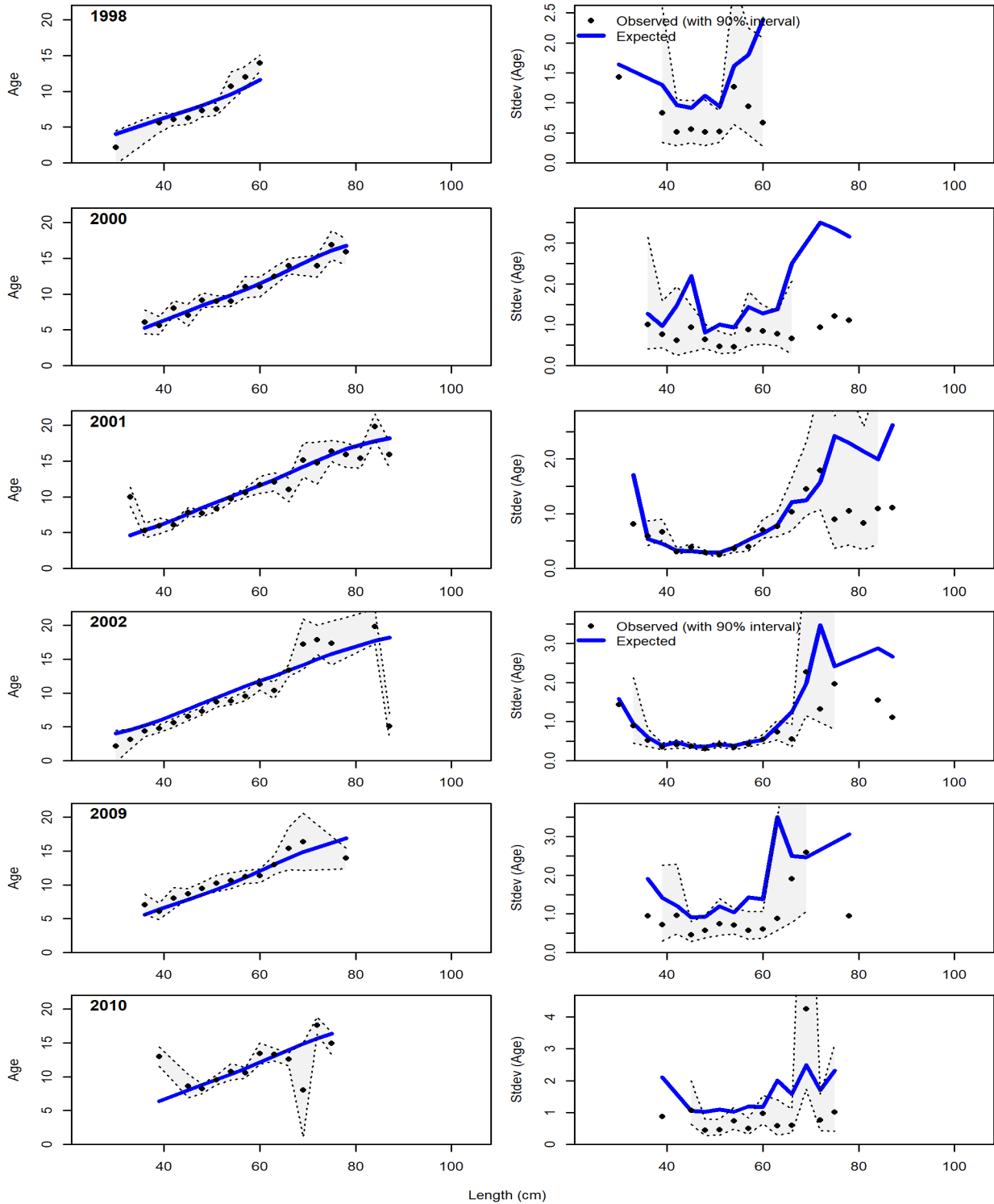

Figure 34C-Continued. Conditional age composition fits for Gulf of Mexico Scamp landed by the Commercial Vertical Line fleet. Left panels are estimated mean age-at-length (observed and expected) at 3 cm FL bins with 90% Confidence Intervals based on adding 1.64 SE of mean to the data. Right panels are the estimated SD of mean age-at-length (observed and expected) at 3 cm FL bins with 90% confidence intervals based on the chi-square distribution.

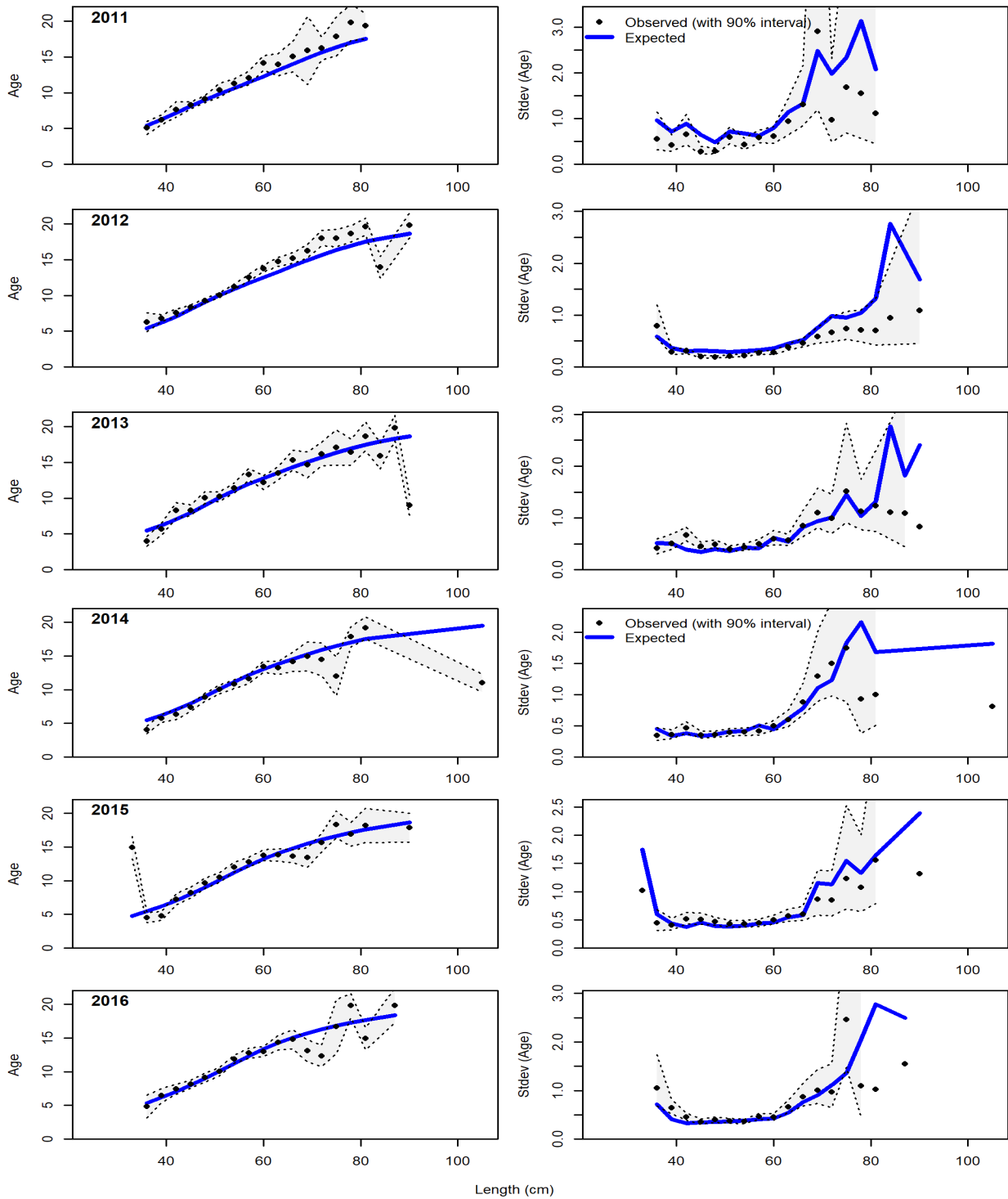

Figure 34C-Continued. Conditional age composition fits for Gulf of Mexico Scamp landed by the Commercial Vertical Line fleet. Left panels are estimated mean age-at-length (observed and expected) at 3 cm FL bins with 90% Confidence Intervals based on adding 1.64 SE of mean to the data. Right panels are the estimated SD of mean age-at-length (observed and expected) at 3 cm FL bins with 90% confidence intervals based on the chi-square distribution.

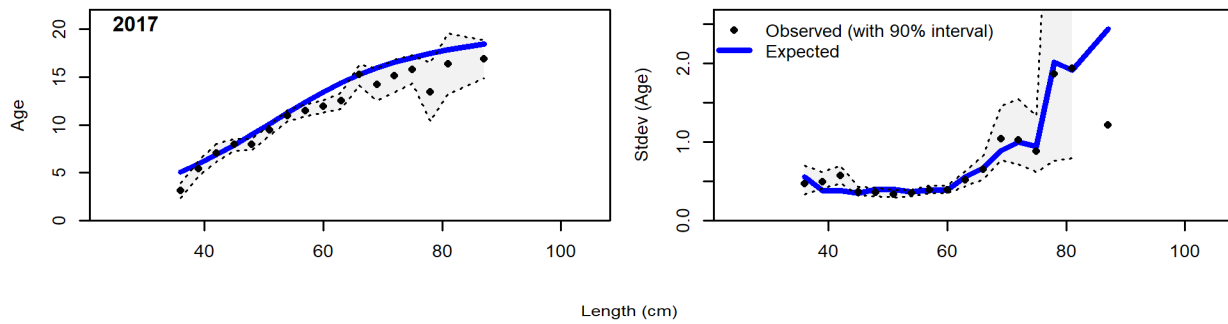

Figure 34C-Continued. Conditional age composition fits for Gulf of Mexico Scamp landed by the Commercial Vertical Line fleet. Left panels are estimated mean age-at-length (observed and expected) at 3 cm FL bins with 90% Confidence Intervals based on adding 1.64 SE of mean to the data. Right panels are the estimated SD of mean age-at-length (observed and expected) at 3 cm FL bins with 90% confidence intervals based on the chi-square distribution.

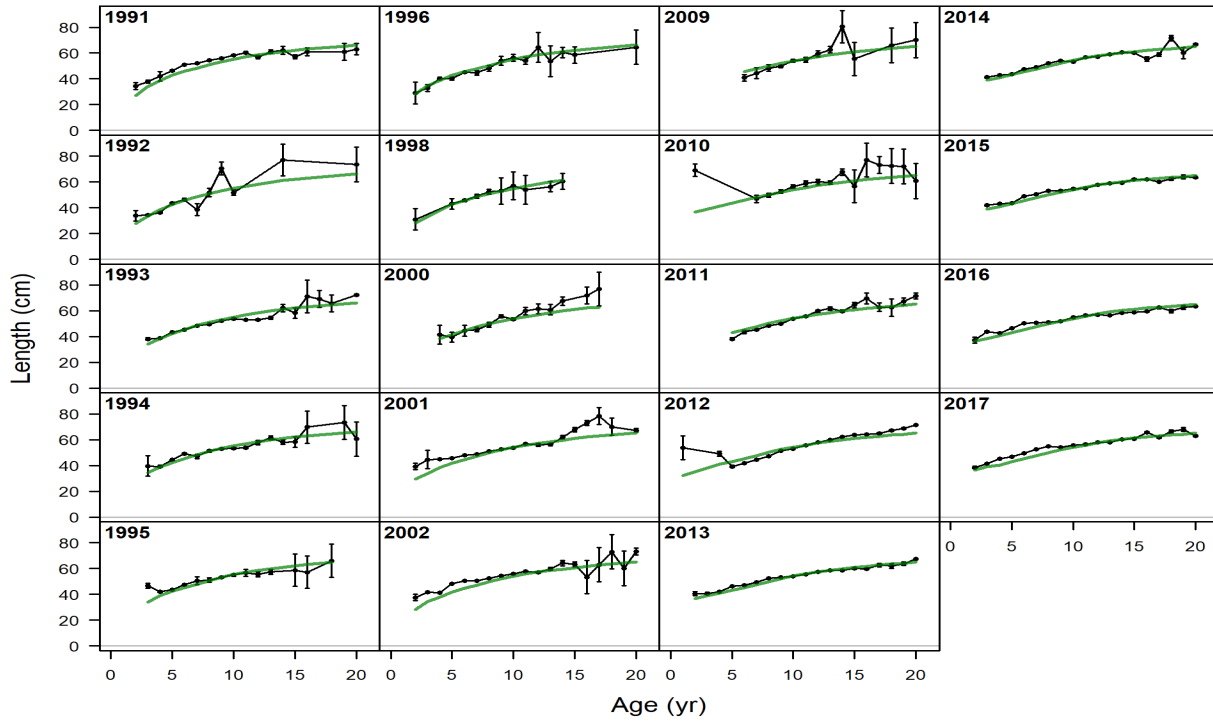

Figure 34D. Observed and expected mean length-at-age (retained) for Gulf of Mexico Scamp landed by the Commercial Vertical Line fleet. Mean length-at-age is provided for comparison of trends and was not included in the likelihood.

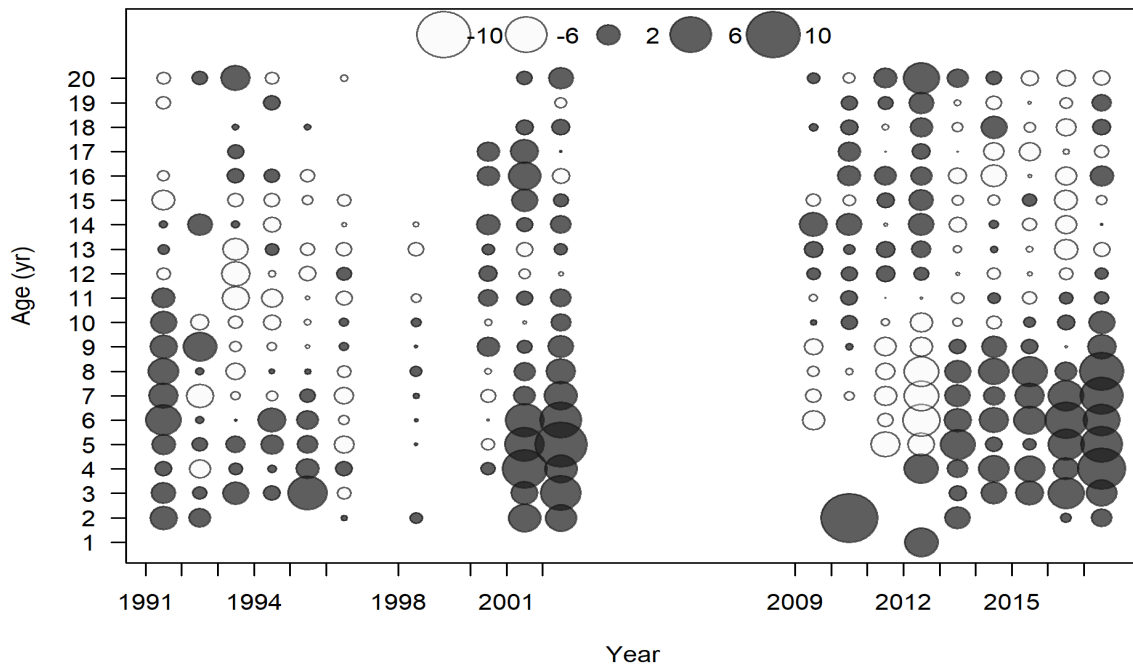

Figure 34E. Pearson residuals for mean length-at-age for Gulf of Mexico Scamp landed by the Commercial Vertical Line fleet. Mean length-at-age is provided for comparison of trends and was not included in the likelihood. Closed bubbles are positive residuals ($Obs > Exp$) and open bubbles are negative residuals ($Obs < Exp$).

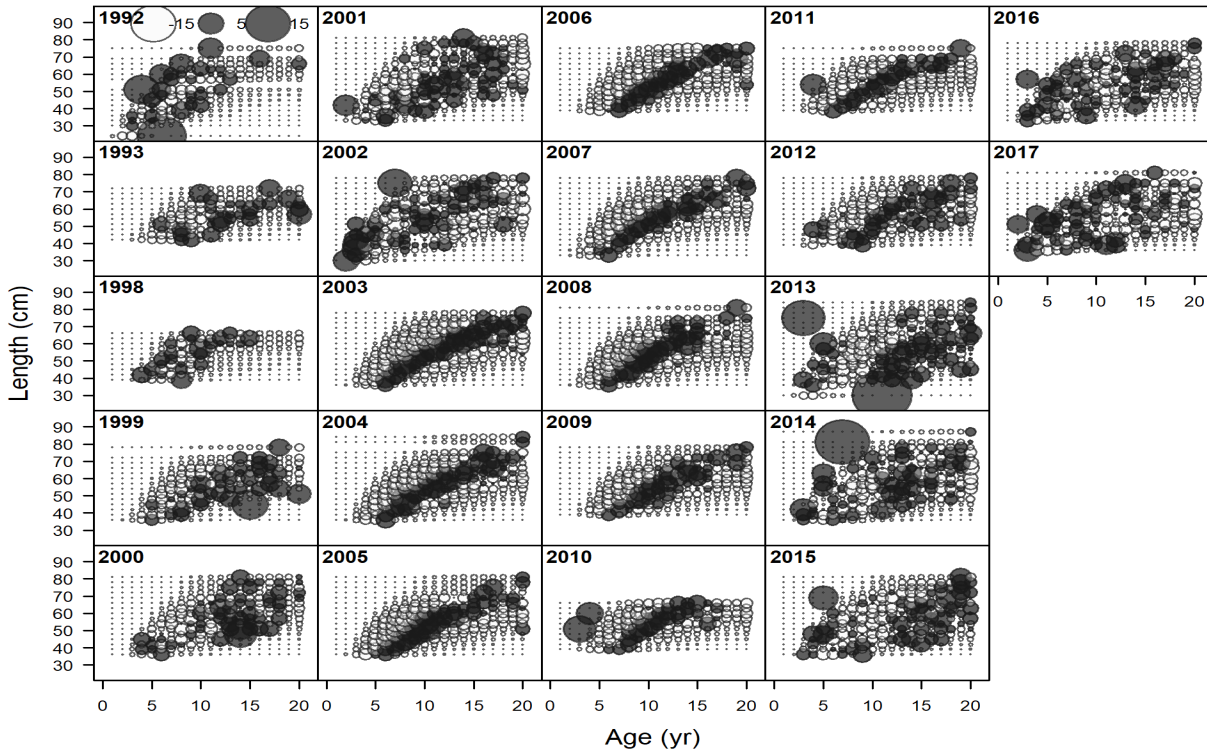

Figure 35A. Observed and expected conditional age-at-length compositions for Gulf of Mexico Scamp landed by the Commercial Longline fleet.

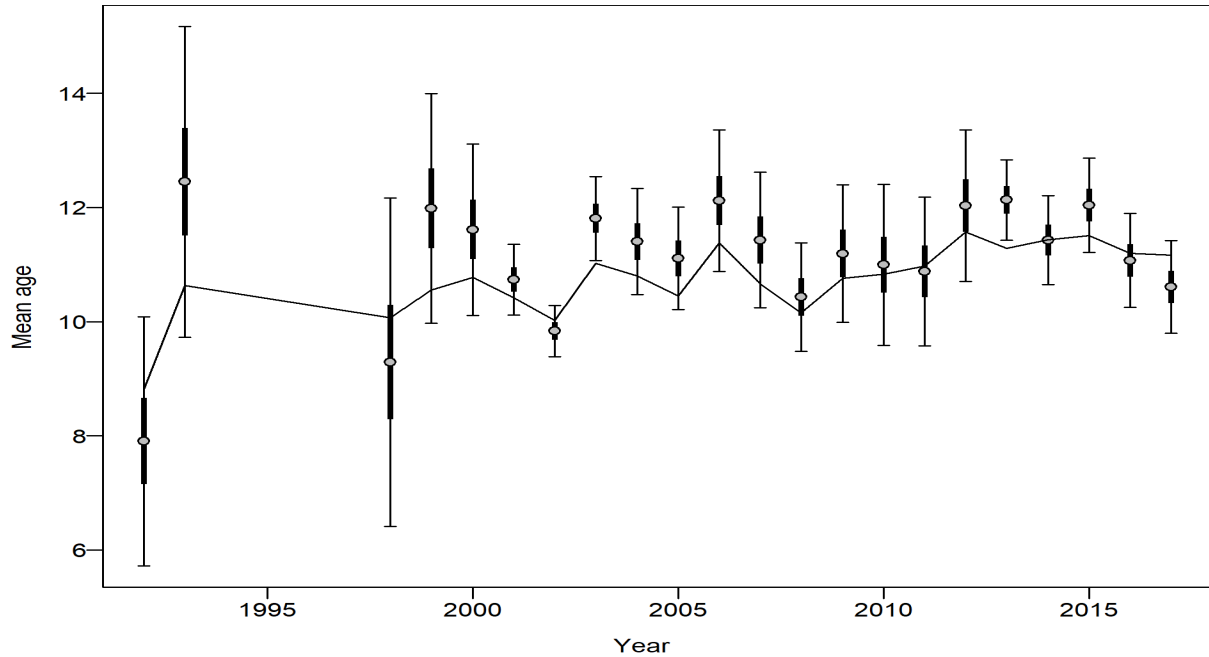

Figure 35B. Mean age of landed Gulf of Mexico Scamp from conditional data (aggregated across length bins) by the Commercial Longline fleet with 95% confidence intervals (thick bars). Thinner intervals (with capped ends) show the result of further adjusting sample sizes based on the Francis data weighting method, which was not used here.

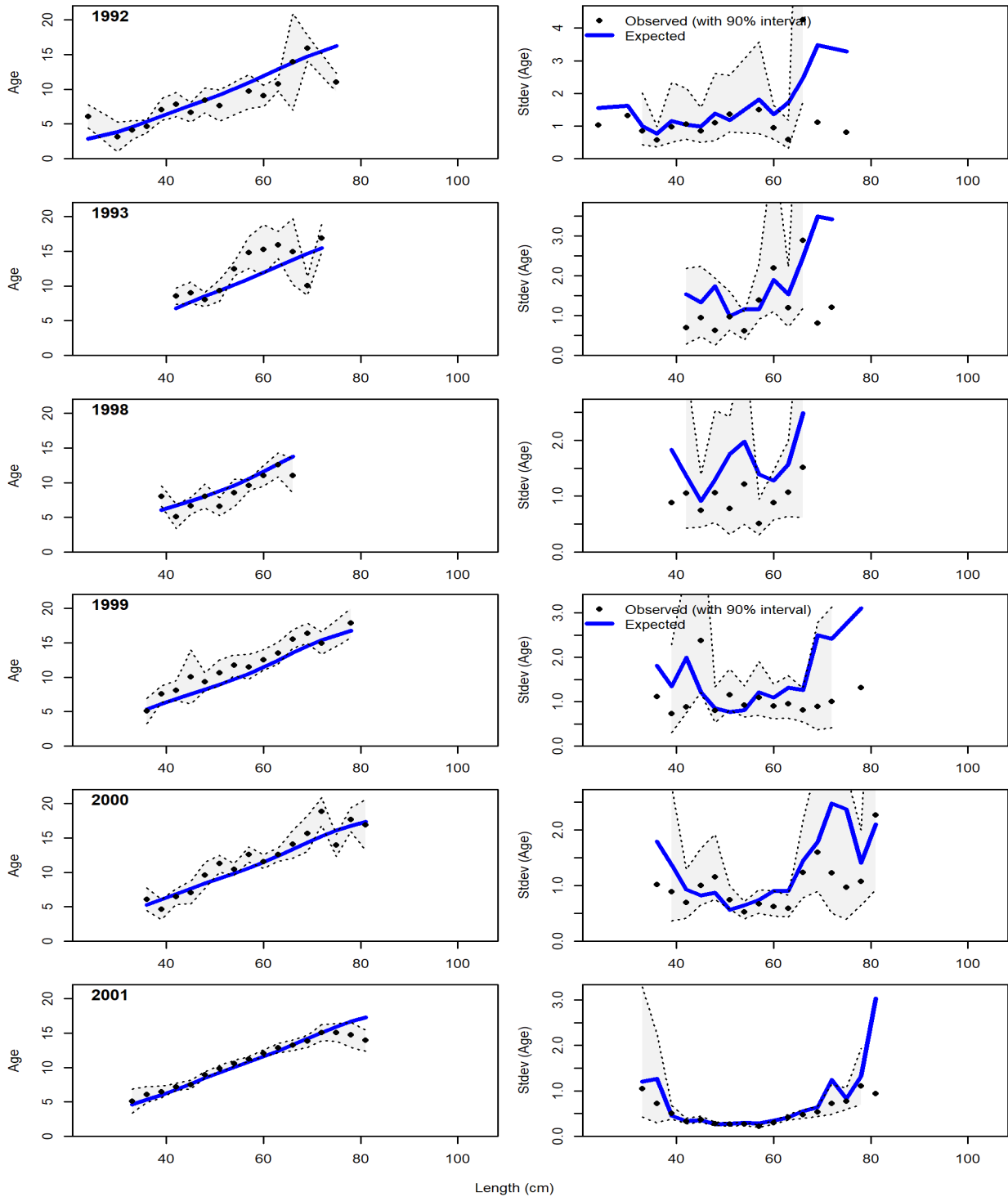

Figure 35C. Conditional age composition fits for Gulf of Mexico Scamp landed by the Commercial Longline fleet. Left panels are estimated mean age-at-length (observed and expected) at 3 cm FL bins with 90% Confidence Intervals based on adding 1.64 SE of mean to the data. Right panels are the estimated SD of mean age-at-length (observed and expected) at 3 cm FL bins with 90% confidence intervals based on the chi-square distribution.

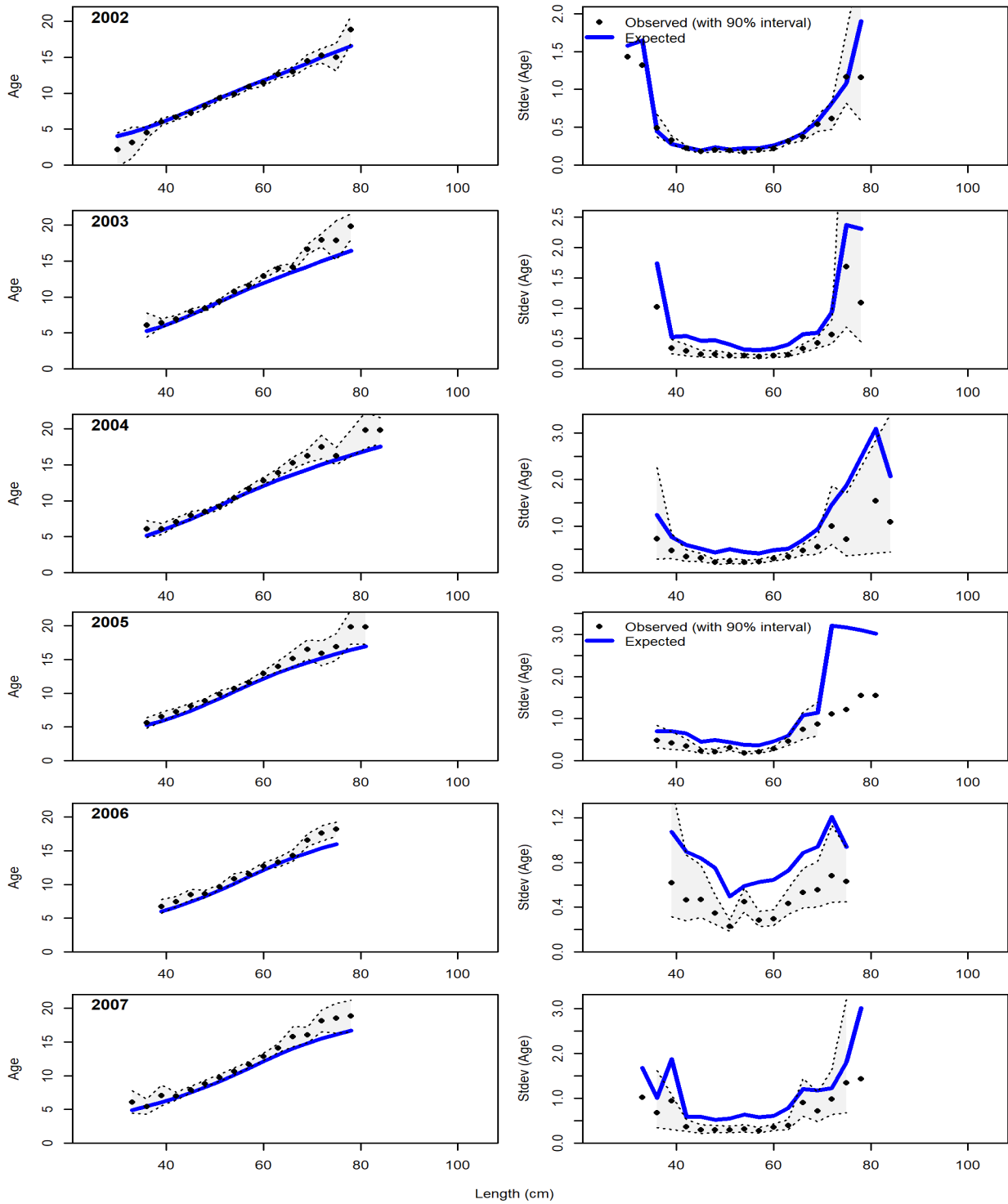

Figure 35C-Continued. Conditional age composition fits for Gulf of Mexico Scamp landed by the Commercial Longline fleet. Left panels are estimated mean age-at-length (observed and expected) at 3 cm FL bins with 90% Confidence Intervals based on adding 1.64 SE of mean to the data. Right panels are the estimated SD of mean age-at-length (observed and expected) at 3 cm FL bins with 90% confidence intervals based on the chi-square distribution.

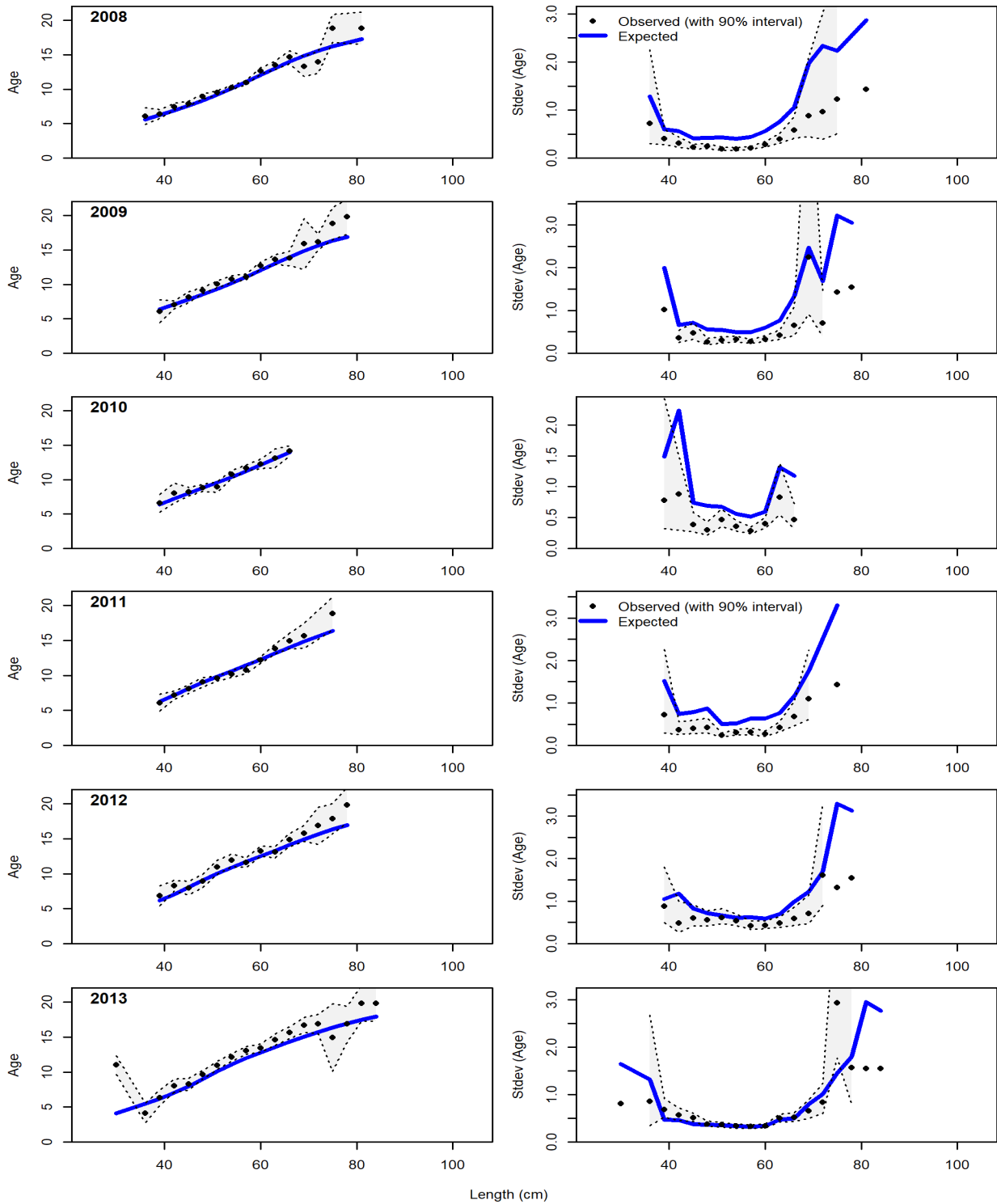

Figure 35C-Continued. Conditional age composition fits for Gulf of Mexico Scamp landed by the Commercial Longline fleet. Left panels are estimated mean age-at-length (observed and expected) at 3 cm FL bins with 90% Confidence Intervals based on adding 1.64 SE of mean to the data. Right panels are the estimated SD of mean age-at-length (observed and expected) at 3 cm FL bins with 90% confidence intervals based on the chi-square distribution.

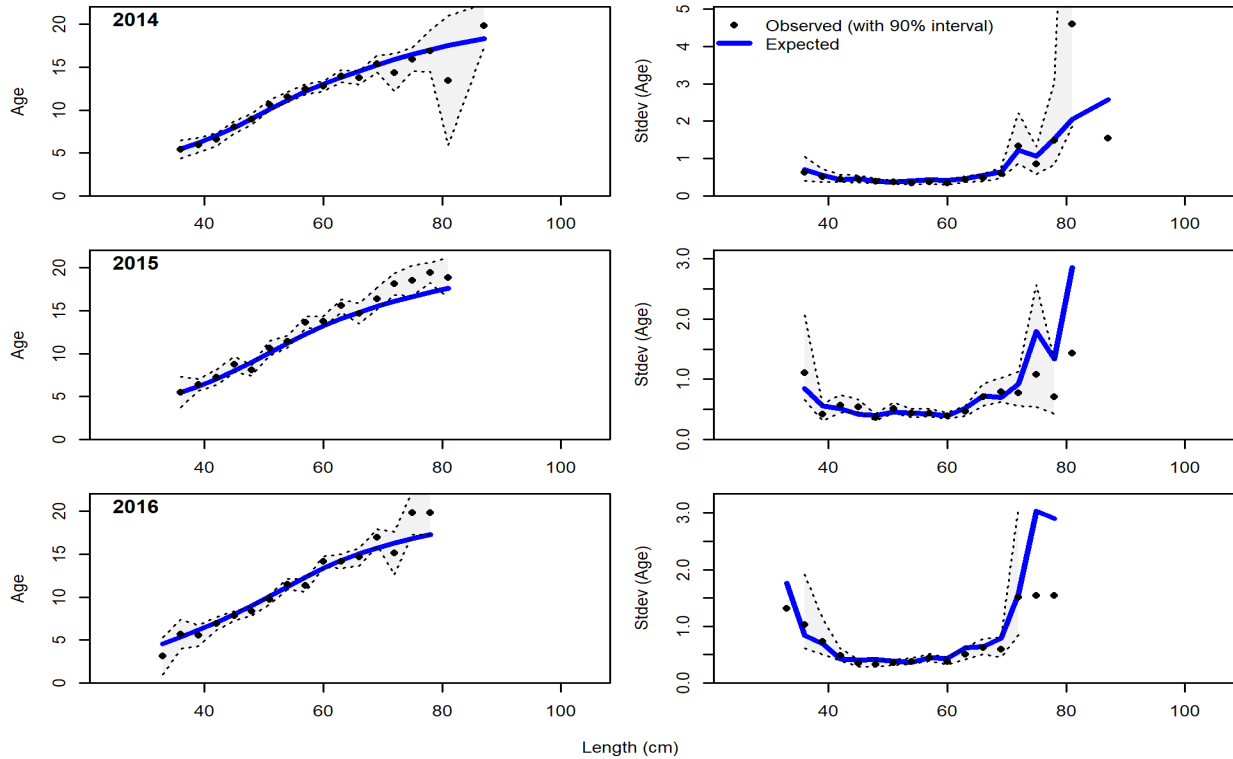

Figure 35C-Continued. Conditional age composition fits for Gulf of Mexico Scamp landed by the Commercial Longline fleet. Left panels are estimated mean age-at-length (observed and expected) at 3 cm FL bins with 90% Confidence Intervals based on adding 1.64 SE of mean to the data. Right panels are the estimated SD of mean age-at-length (observed and expected) at 3 cm FL bins with 90% confidence intervals based on the chi-square distribution.

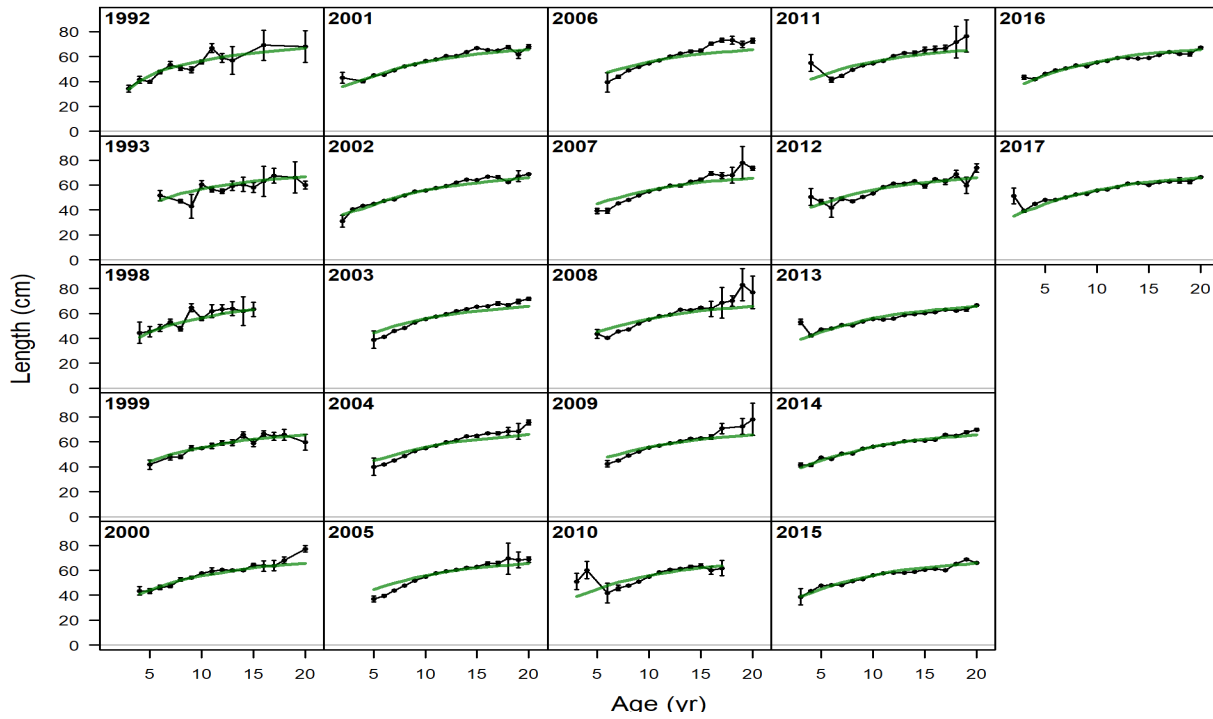

Figure 35D. Observed and expected mean length-at-age for Gulf of Mexico Scamp landed by the Commercial Longline fleet. Mean length-at-age is provided for comparison of trends and was not included in the likelihood.

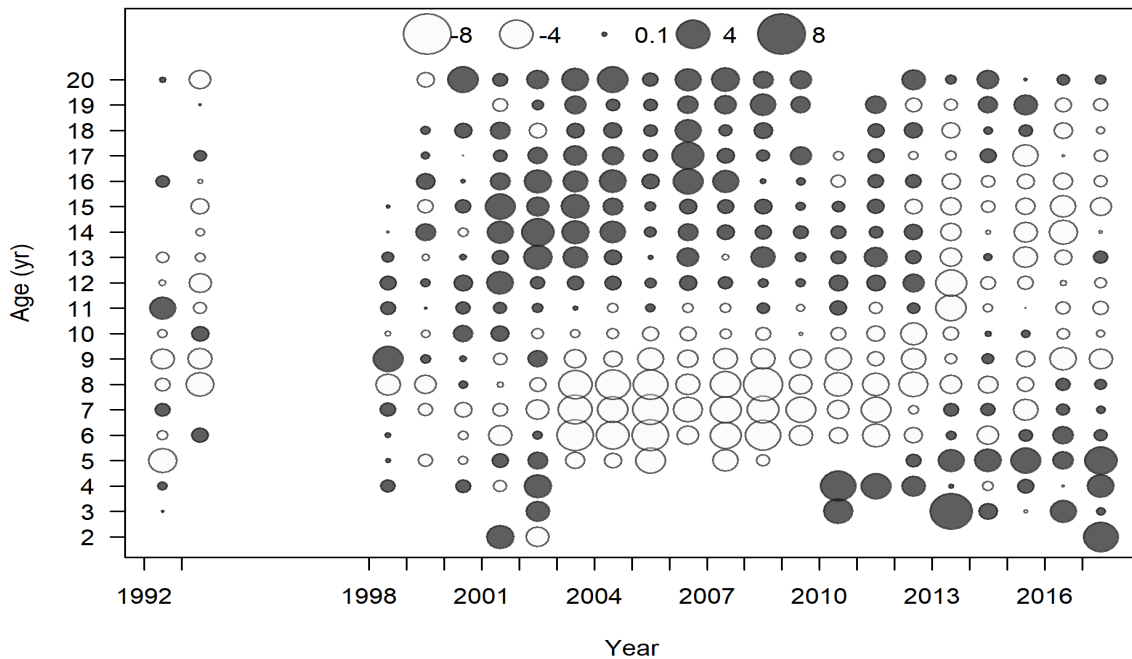

Figure 35E. Pearson residuals for mean length-at-age for Gulf of Mexico Scamp landed by the Commercial Longline fleet. Mean length-at-age is provided for comparison of trends and was not included in the likelihood. Closed bubbles are positive residuals ($Obs > Exp$) and open bubbles are negative residuals ($Obs < Exp$).

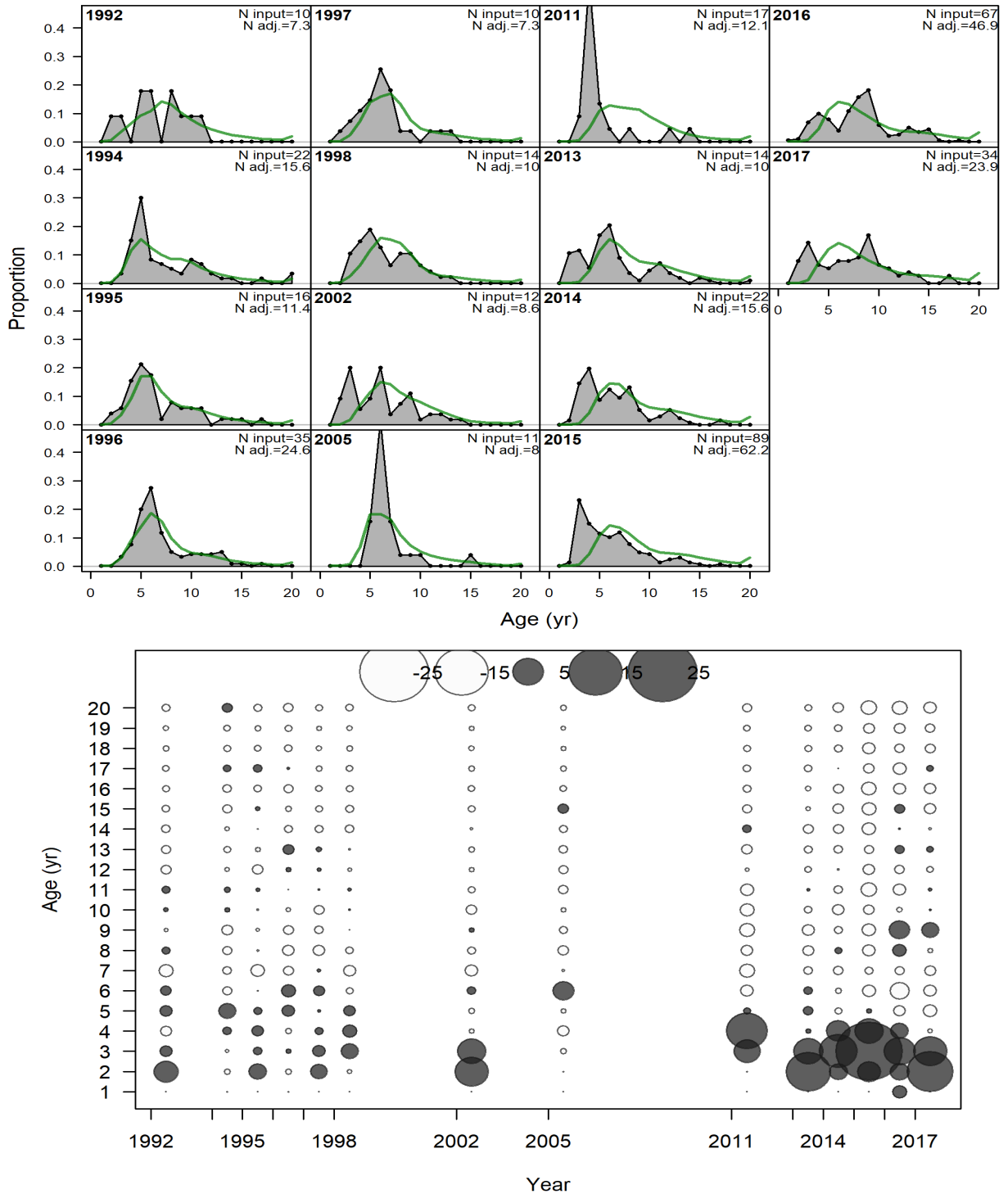

Figure 36A. Observed and expected age compositions and Pearson residuals for Gulf of Mexico Scamp landed by the Recreational Charter Private fleet. Green lines represent expected length compositions, while grey shaded regions represent observed length compositions. Input sample sizes (N input) and adjusted sample sizes (N adj) estimated by SS are also reported. Closed bubbles are positive residuals ($Obs > Exp$) and open bubbles are negative residuals ($Obs < Exp$).

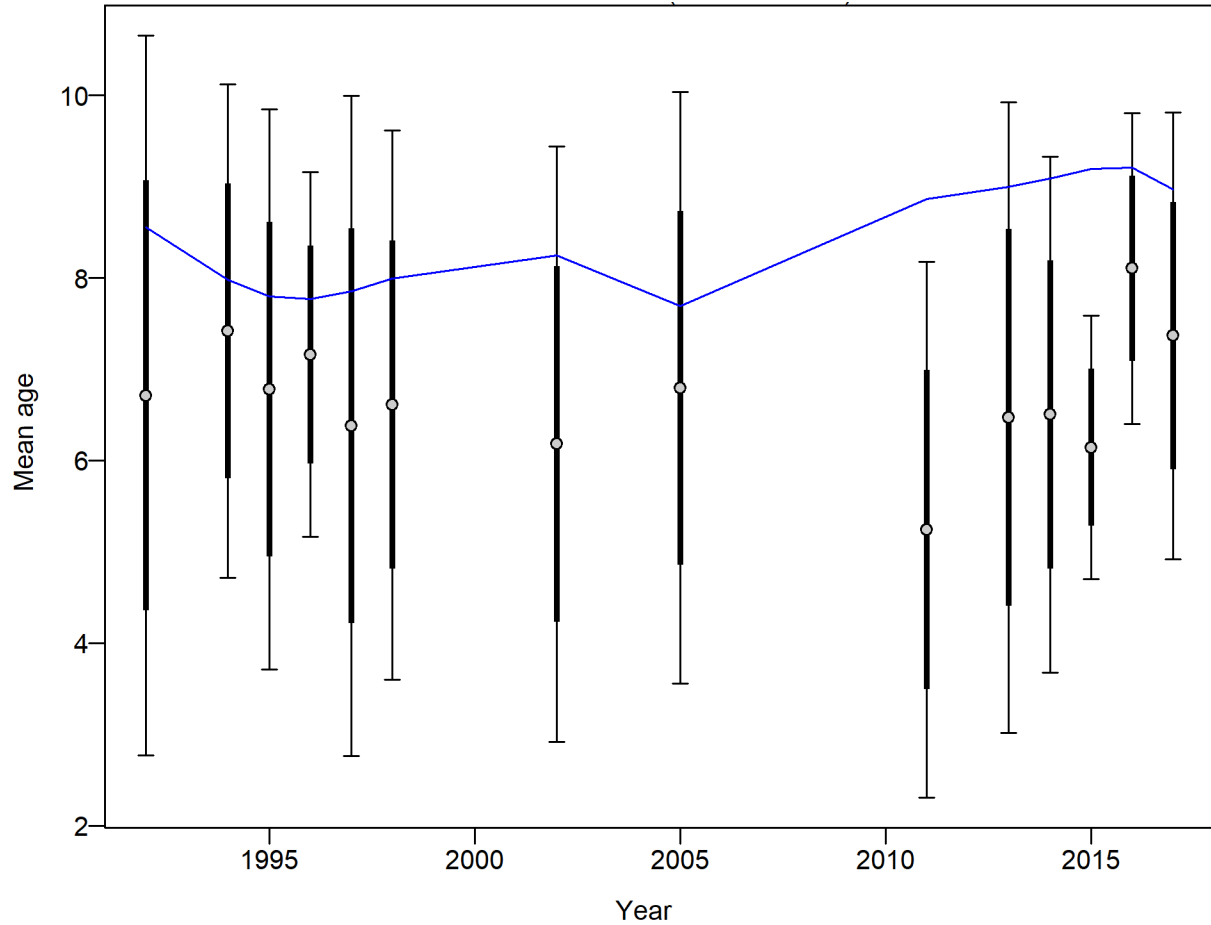

Figure 36B. Mean age of landed Gulf of Mexico Scamp from data (aggregated across length bins) by the Recreational Charter Private fleet with 95% confidence intervals (thick bars). Thinner intervals (with capped ends) show the result of further adjusting sample sizes based on the Francis data weighting method, which was not used here.

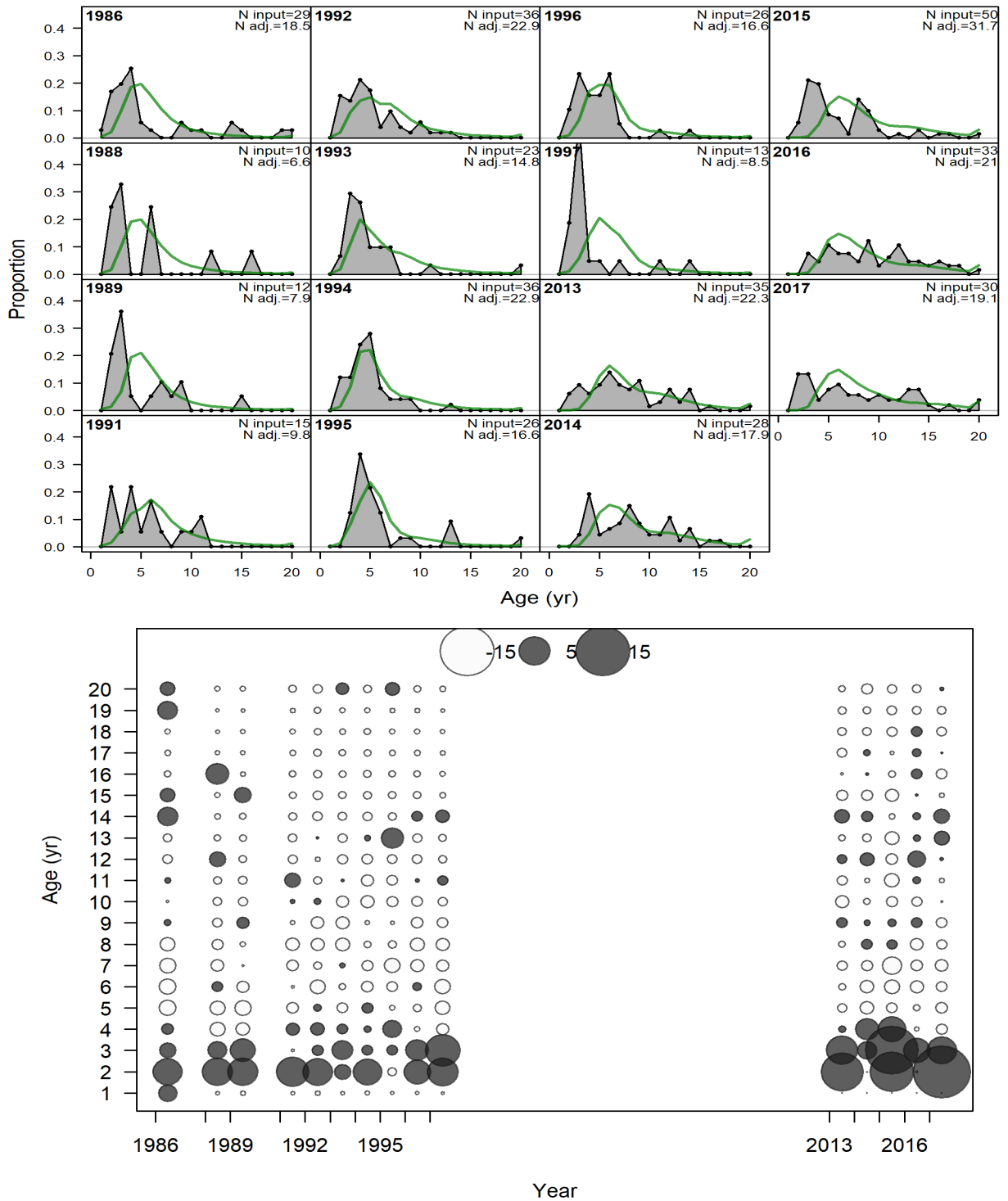

Figure 37A. Observed and expected age compositions and Pearson residuals for Gulf of Mexico Scamp landed by the Recreational Headboat fleet. Green lines represent expected length compositions, while grey shaded regions represent observed length compositions. Input sample sizes (N_{input}) and adjusted sample sizes (N_{adj}) estimated by SS are also reported. Closed bubbles are positive residuals ($Obs > Exp$) and open bubbles are negative residuals ($Obs < Exp$).

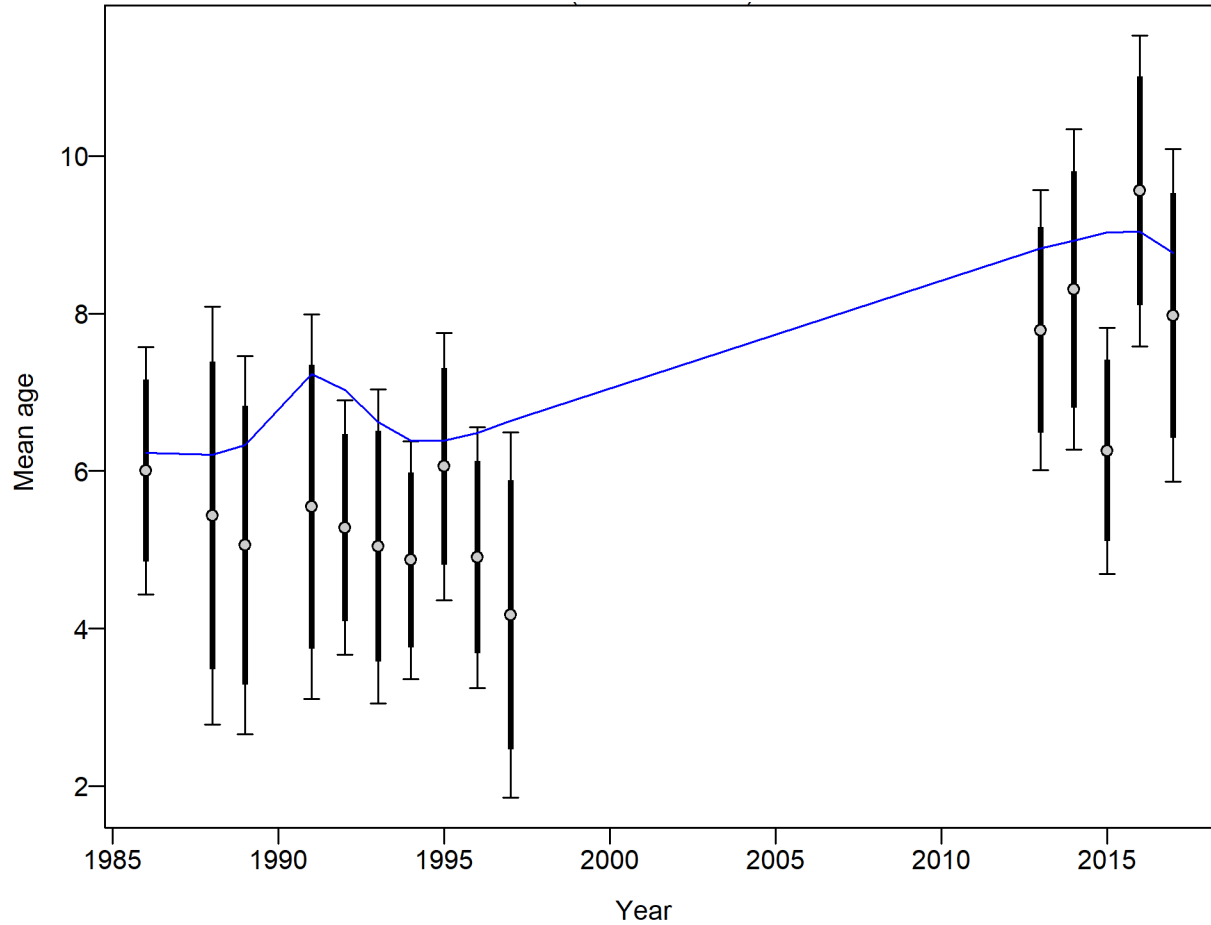

Figure 37B. Mean age of landed Gulf of Mexico Scamp from data (aggregated across length bins) by the Recreational Headboat fleet with 95% confidence intervals (thick bars). Thinner intervals (with capped ends) show the result of further adjusting sample sizes based on the Francis data weighting method, which was not used here.

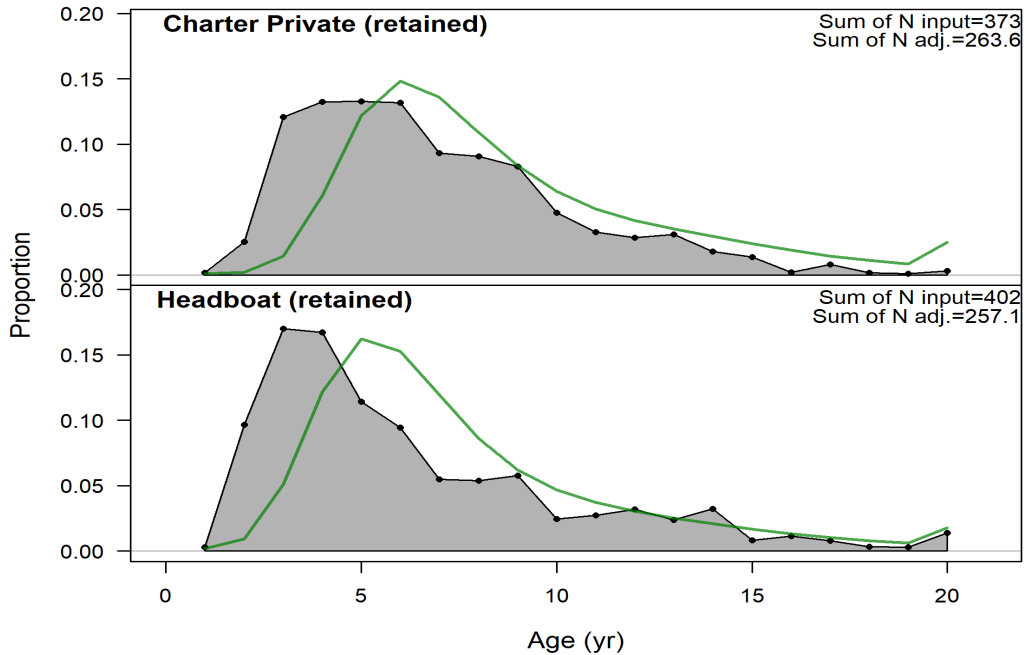

Figure 38. Model fits to the age composition of landed Scamp aggregated across years within a given fleet for the Gulf of Mexico. Green lines represent expected age compositions, while grey shaded regions represent observed age compositions. The input (N_{input}) and adjusted (N_{adj}) sample sizes are provided in the upper right corner of each panel.

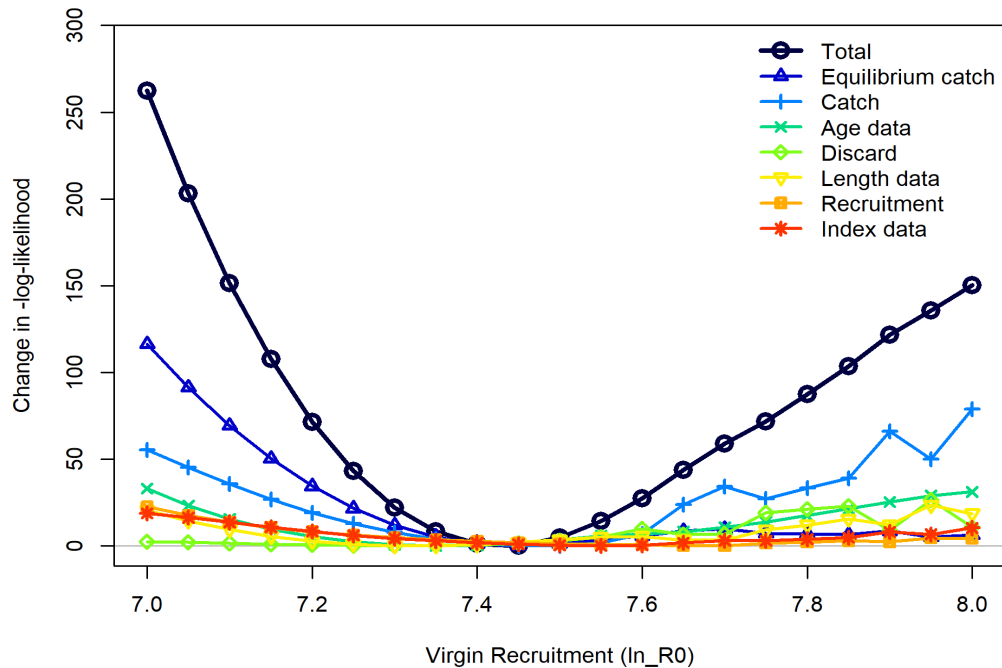

Figure 39A. The profile likelihood for the natural log of the virgin recruitment parameter of the Beverton – Holt stock-recruit function for Gulf of Mexico Scamp. Each line represents the change in negative log-likelihood value for each of the data sources fit in the model across the range of fixed values tested. The MLE (CV) for the SEDAR 68 AP Base Model was 7.433 (0.003).

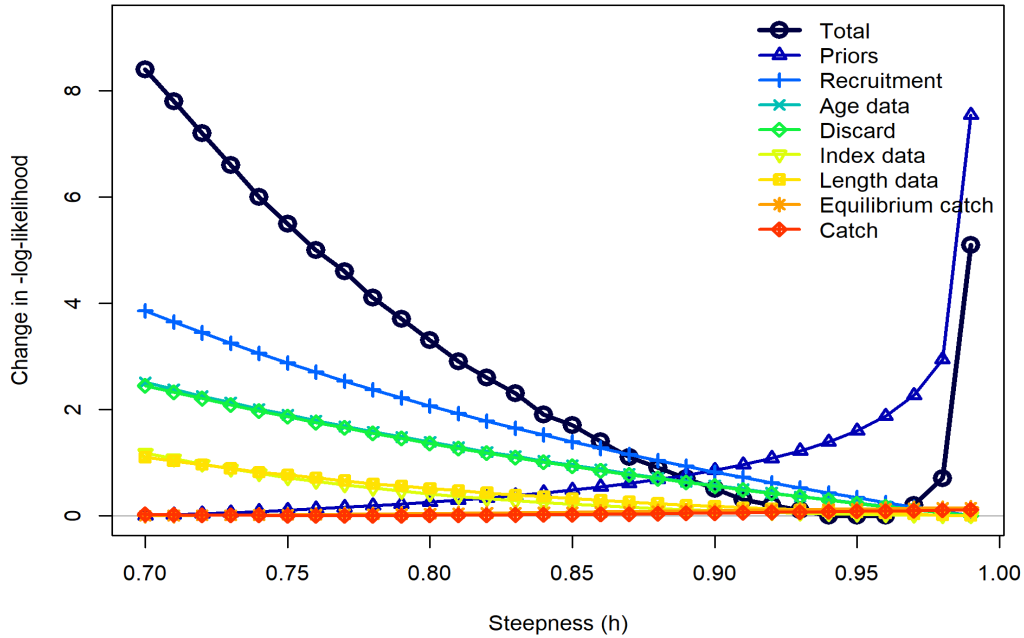

Figure 39B. The profile likelihood for the steepness parameter of the Beverton – Holt stock-recruit function using a prior for Gulf of Mexico Scamp. Each line represents the change in negative log-likelihood value for each of the data sources fit in the model across the range of fixed values tested. The MLE (CV) for the SEDAR 68 AP Base Model was 0.949 (0.041) using a prior.

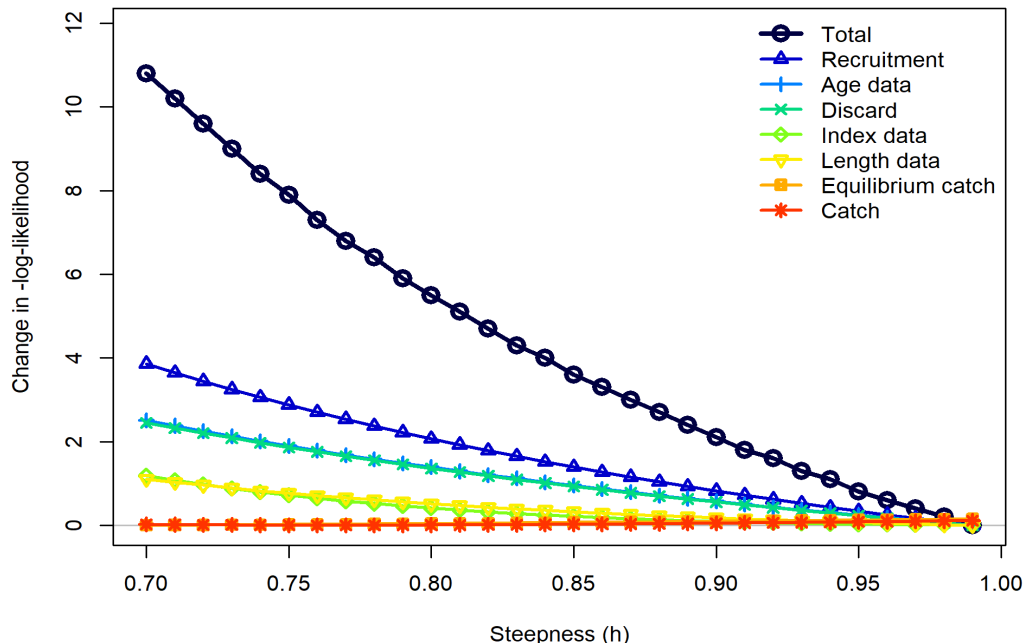

Figure 39C. The profile likelihood for the steepness parameter of the Beverton – Holt stock-recruit function with no prior for Gulf of Mexico Scamp. Each line represents the change in negative log-likelihood value for each of the data sources fit in the model across the range of fixed values tested. The MLE (CV) for the SEDAR 68 AP Base Model was 0.949 (0.041) using a prior. Estimated steepness bounded out at 0.99 in the absence of a prior.

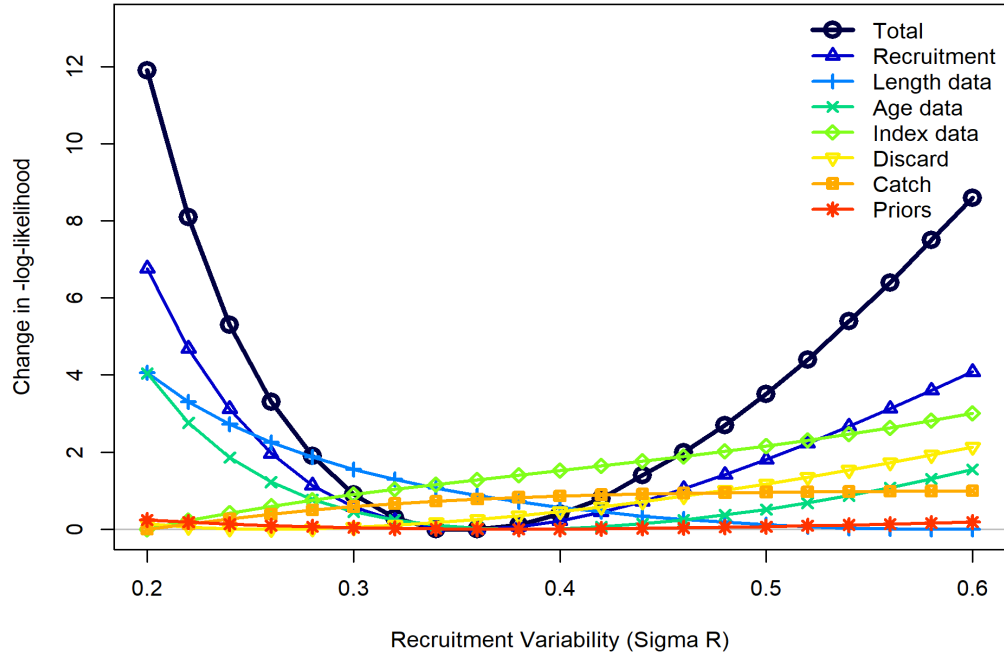

Figure 39D. The profile likelihood for the recruitment variability (σR) parameter of the Beverton – Holt stock-recruit function for Gulf of Mexico Scamp. Each line represents the change in negative log-likelihood value for each of the data sources fit in the model across the range of fixed values tested. The MLE (CV) for the SEDAR 68 AP Base Model was 0.356 (0.127).

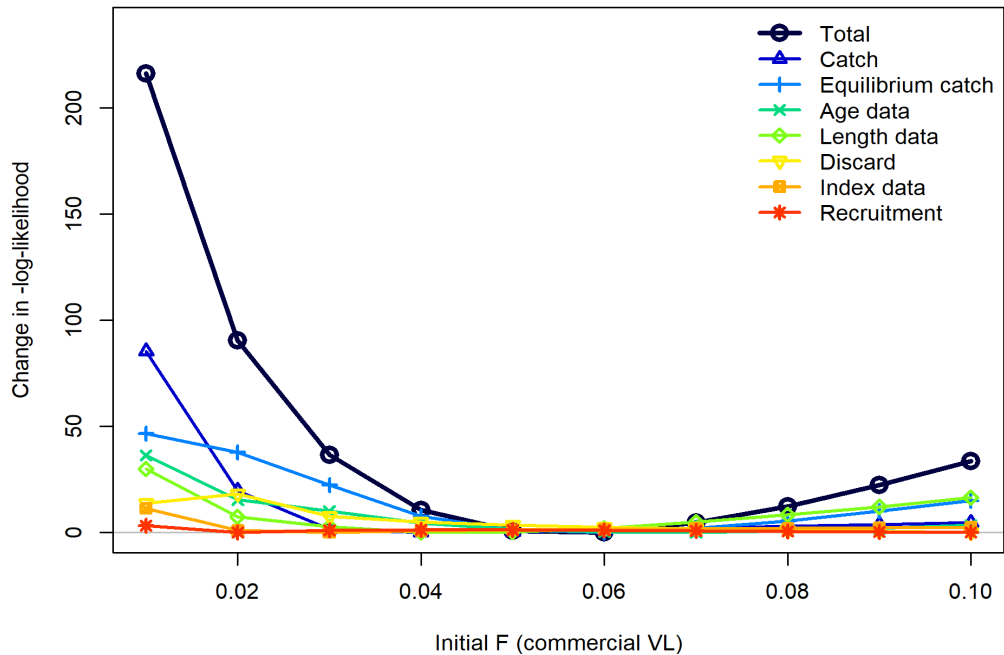

Figure 39E. The profile likelihood for the initial fishing mortality rate for the Commercial Vertical Line fleet. Each line represents the change in negative log-likelihood value for each of the data sources fit in the model across the range of fixed values tested. The MLE (CV) for the SEDAR 68 AP Base Model was 0.056 (0.071).

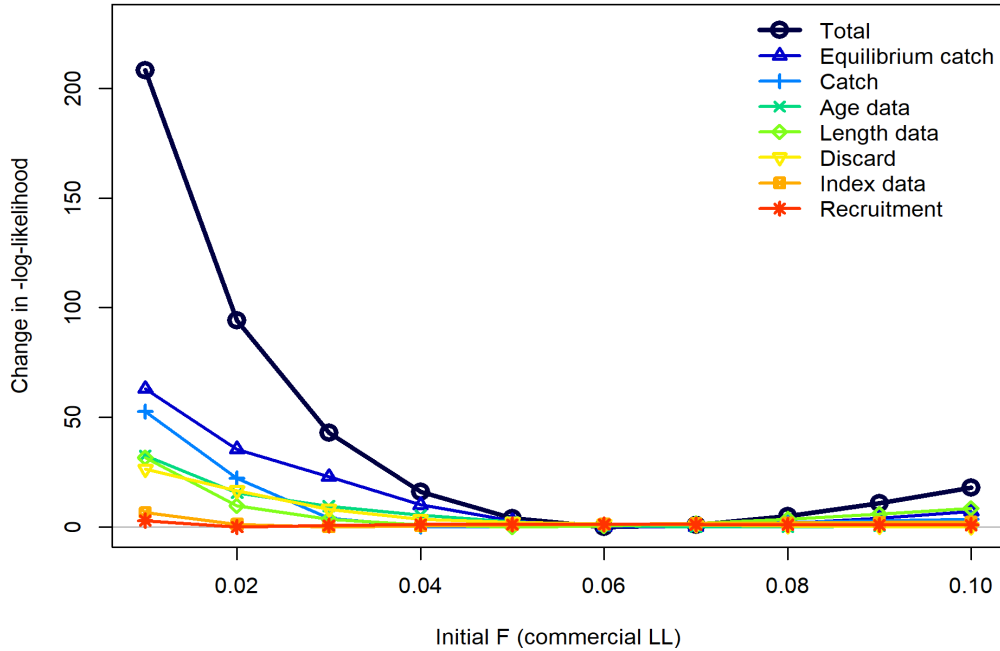

Figure 39F. The profile likelihood for the initial fishing mortality rate for the Commercial Longline fleet. Each line represents the change in negative log-likelihood value for each of the data sources fit in the model across the range of fixed values tested. The MLE (CV) for the SEDAR 68 AP Base Model was 0.062 (0.078).

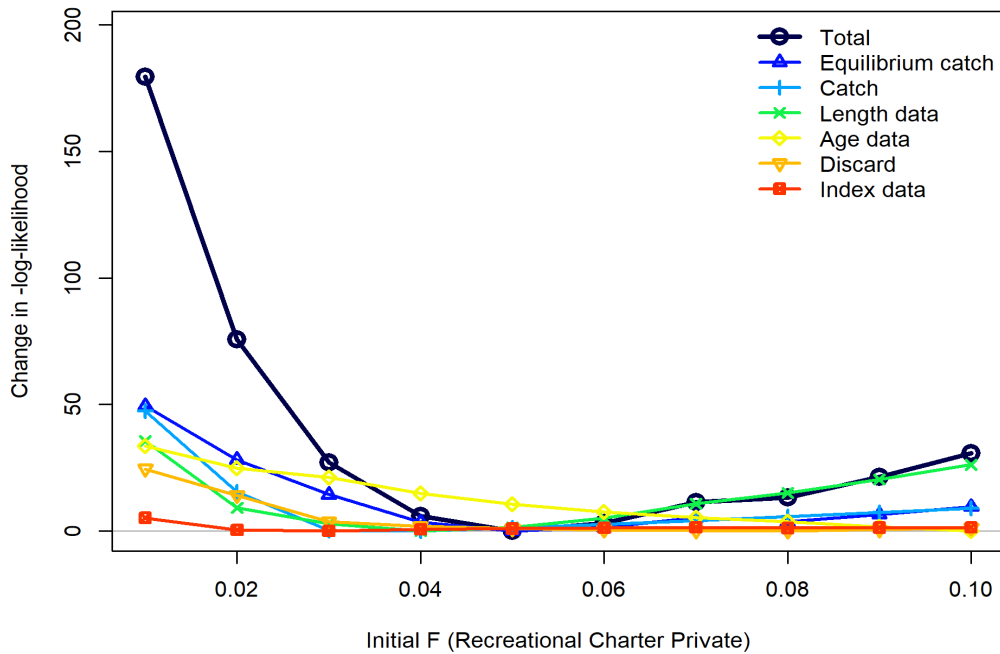

Figure 39G. The profile likelihood for the initial fishing mortality rate for the Recreational Charter Private fleet. Each line represents the change in negative log-likelihood value for each of the data sources fit in the model across the range of fixed values tested in the profile diagnostic run. The MLE (CV) for the SEDAR 68 AP Base Model was 0.051 (0.068).

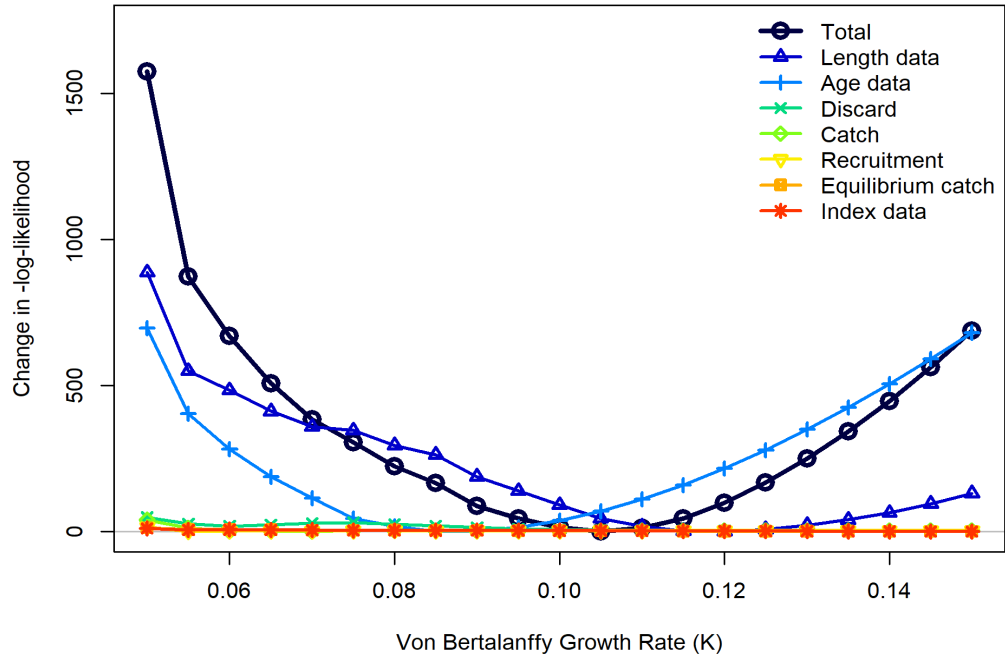

Figure 39H. The profile likelihood for the von Bertalanffy growth rate parameter. Each line represents the change in negative log-likelihood value for each of the data sources fit in the model across the range of fixed values tested in the profile diagnostic run. This parameter was fixed at 0.134, which was recommended by the SEDAR 68 DW LHWG.

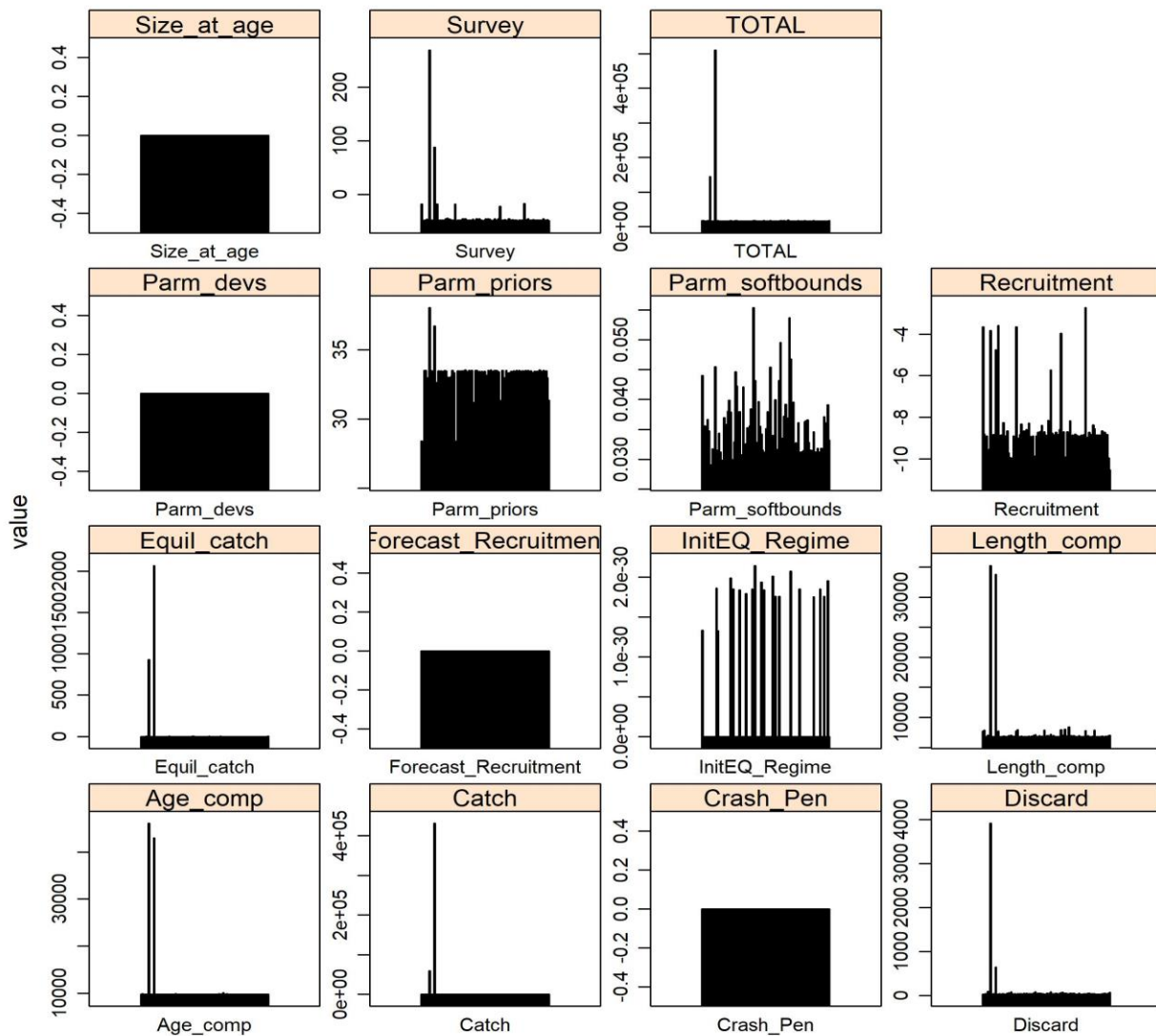

Figure 40A. Results of the jitter analysis for various likelihood components for the SEDAR 68 AP Base Model for Gulf of Mexico Scamp. Each panel gives the results of 100 model runs where the starting parameter values for each run were randomly changed ('jittered') by 10% from the SEDAR 68 AP Base Model best fit values. Note that the y-axes differ between panels. Negative log-likelihood components shown from top left through bottom right include: size-at-age, survey, total, parameter deviations (Parm_devs), parameter priors (Parm_priors), parameter softbounds (Parm_softbounds), recruitment, equilibrium catch (Equil_catch), forecast recruitment, initial equilibrium regime (InitEQ_Regime), length composition (length_comp), age composition (age_comp), catch, crash penalty (Crash_Pen), and discards.

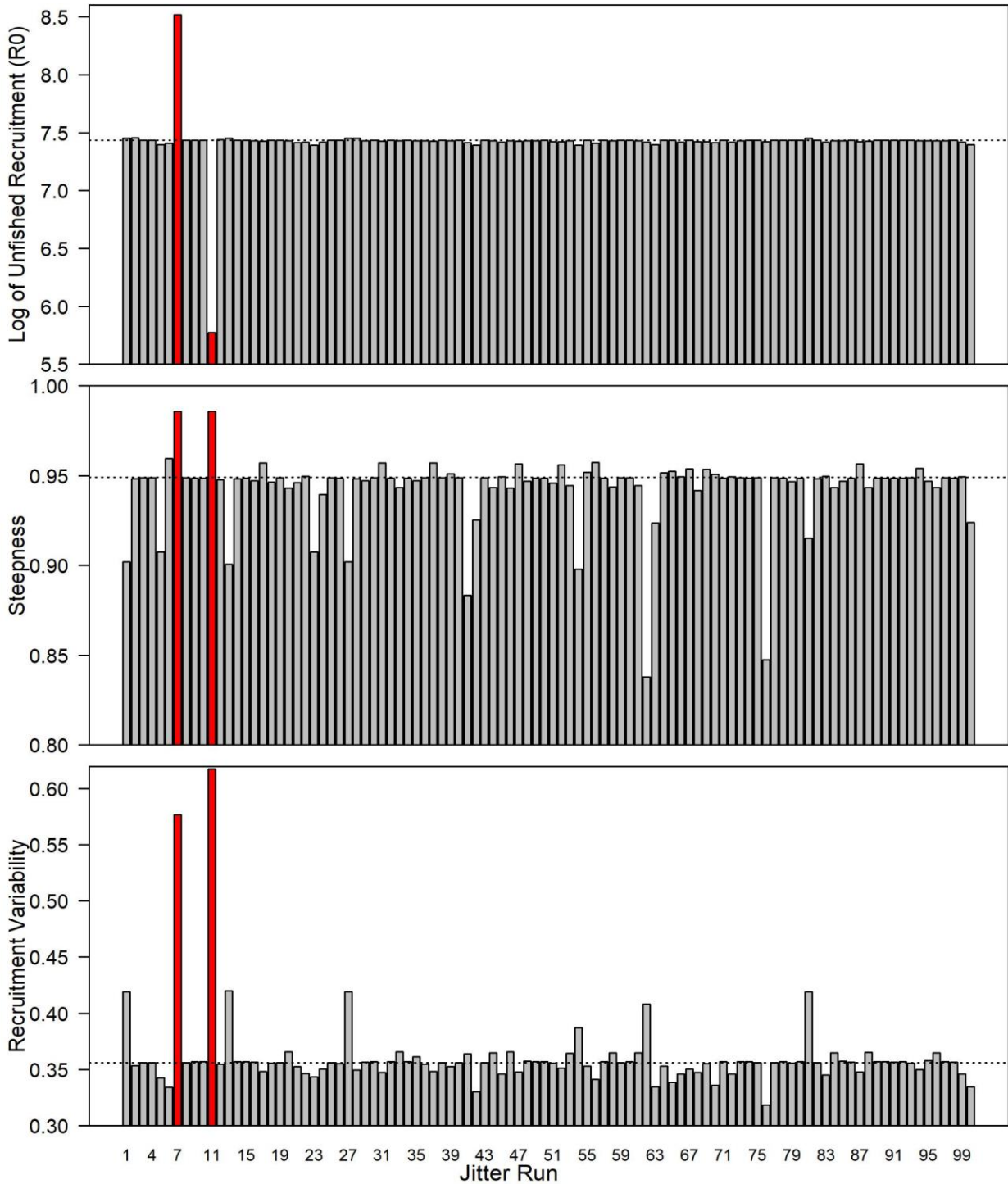

Figure 40B. Results of the jitter analysis for the three key recruitment parameters for the SEDAR 68 AP Base Model for Gulf of Mexico Scamp. Each panel gives the model estimates for each parameter from 100 model runs where the starting parameter values for each run were randomly changed ('jittered') by 10% from the SEDAR 68 AP Base Model best fit values (shown in each panel by dashed horizontal lines). Red bars indicate the two jitter runs which displayed very poor gradients and large negative log-likelihoods and likely reflect models that would not converge.

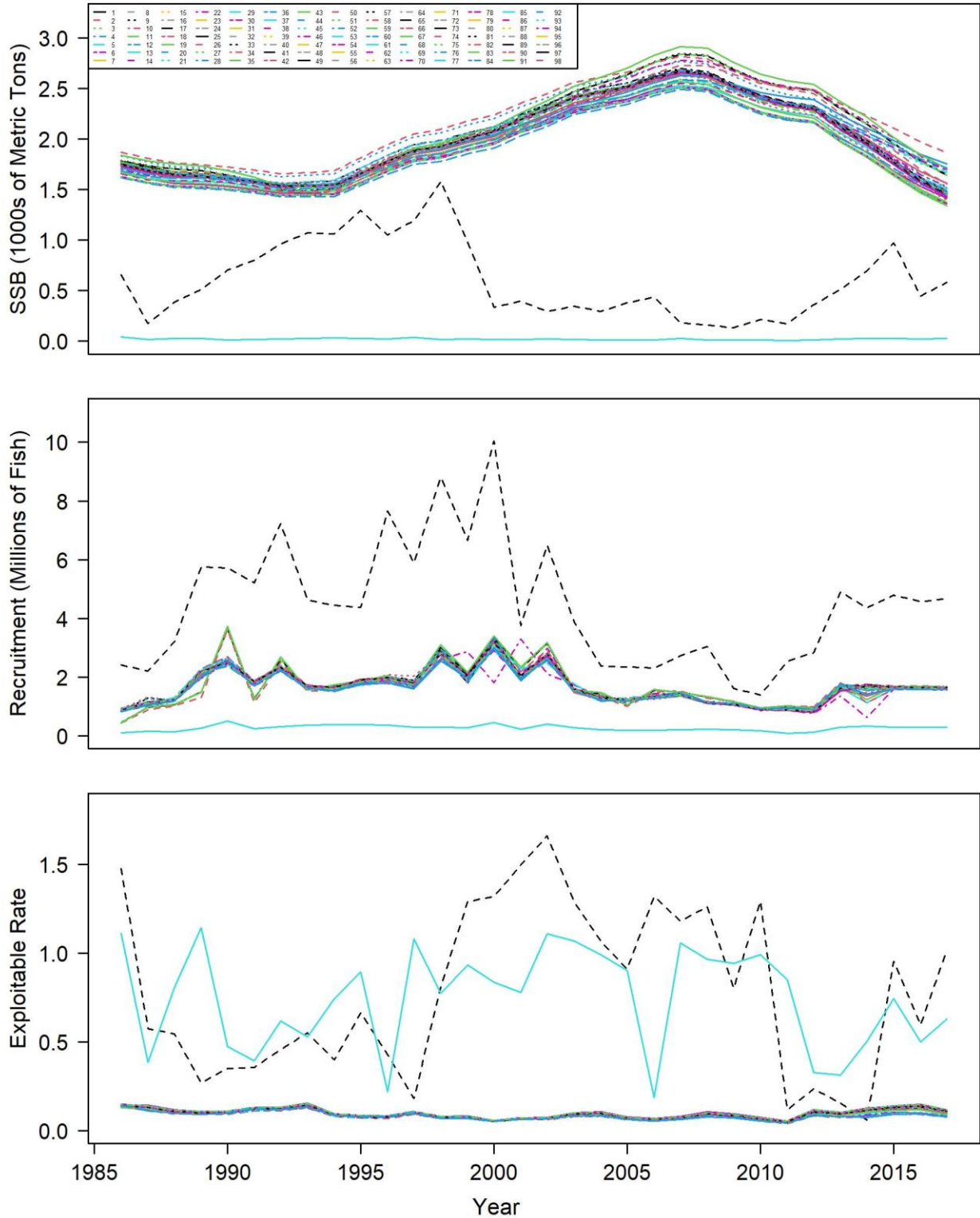

Figure 40C. Estimated trajectories in spawning stock biomass (SSB, 1,000s of metric tons; top panel), recruitment (millions of fish; middle panel), and fishing mortality (total biomass killed age 3+ / total biomass age 3+; bottom panel) for the SEDAR 68 AP Base Model for Gulf of Mexico Scamp.

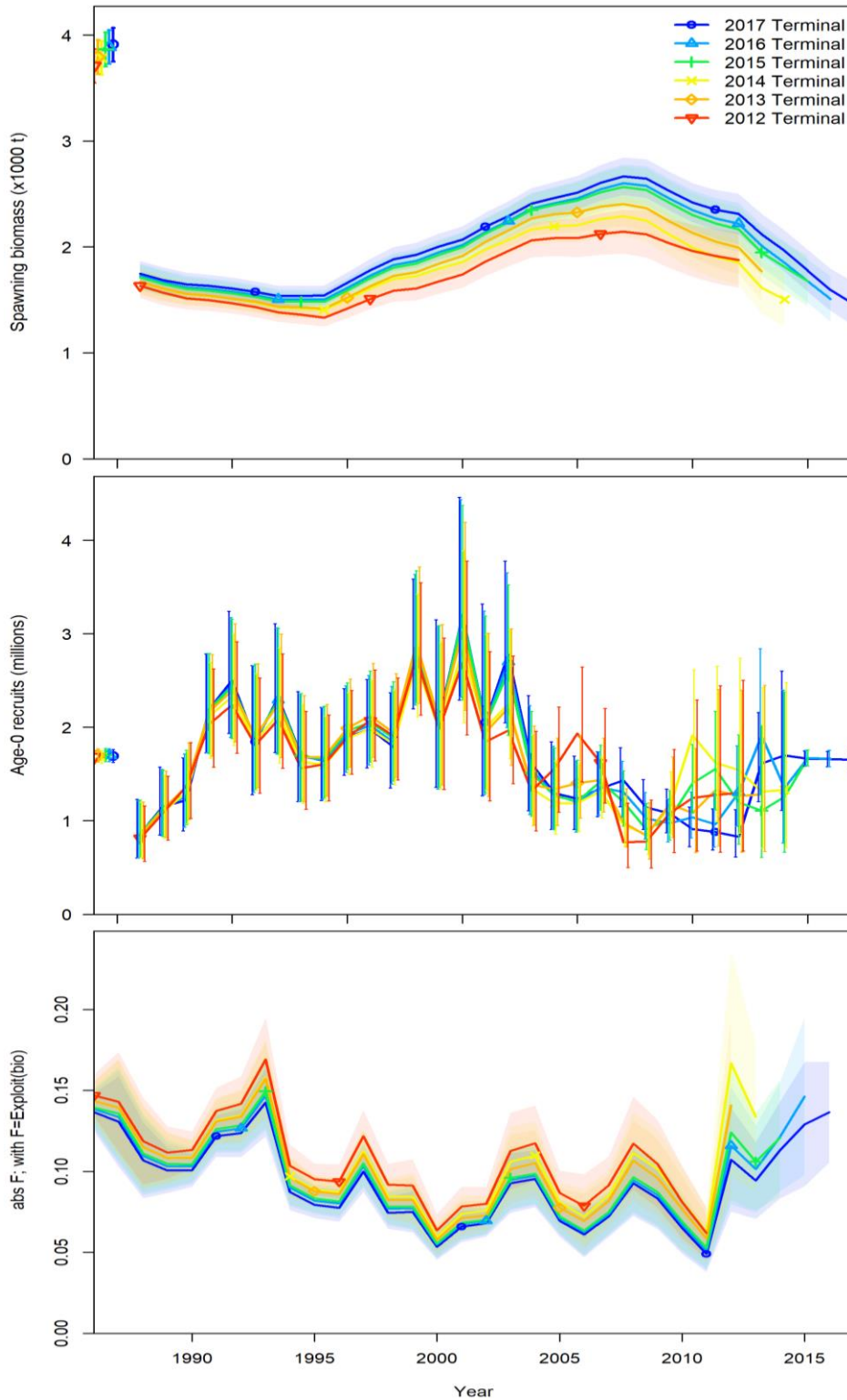

Figure 41. Results of a five year retrospective analysis for spawning biomass (1,000s of metric tons; top panel), recruitment (millions of fish; middle panel), and fishing mortality (total biomass killed age 3+ / total biomass age 3+; bottom panel) for the SEDAR 68 AP Base Model for Gulf of Mexico Scamp.

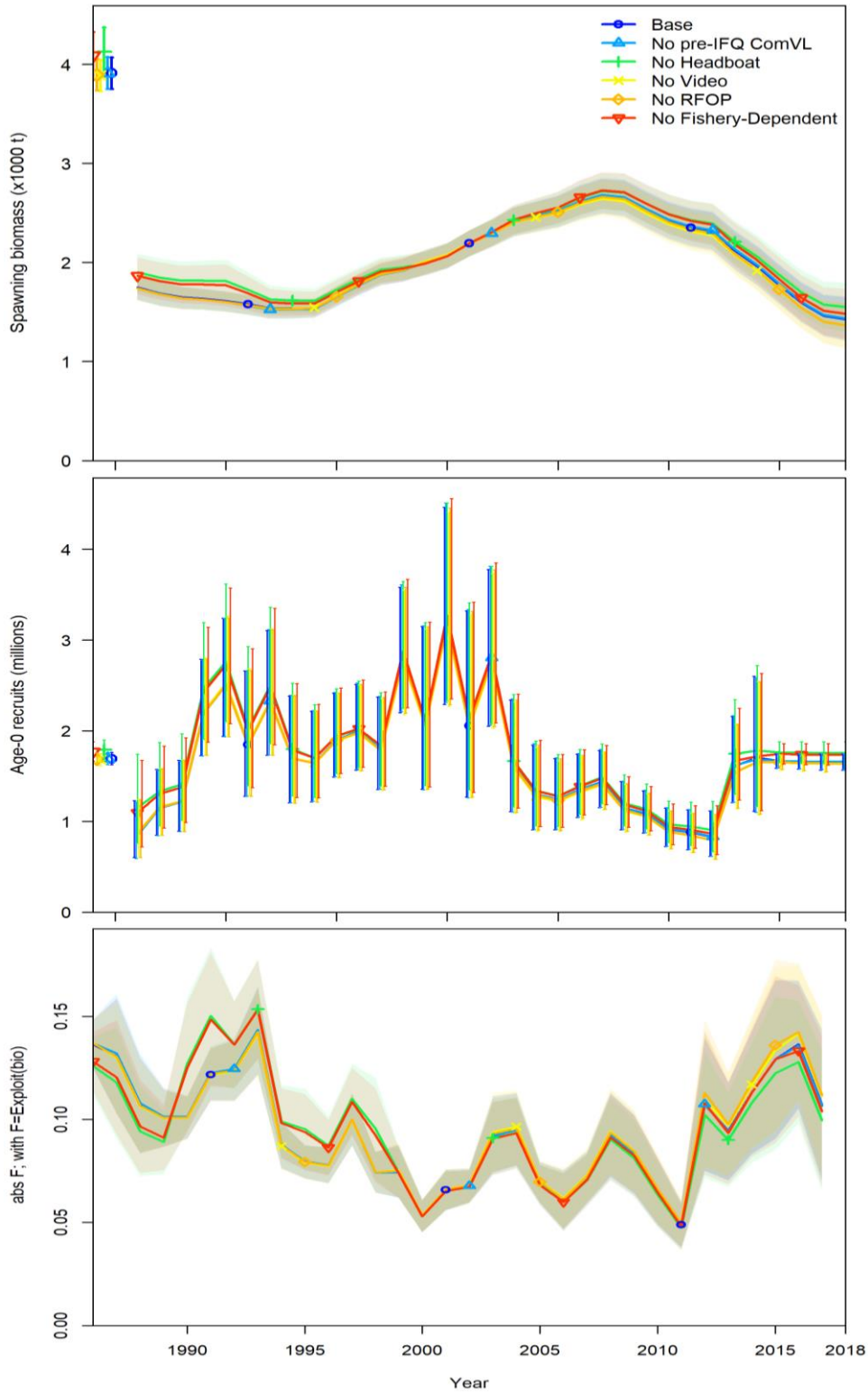

Figure 42. Estimates of spawning stock biomass (1,000s of metric tons; top panel), recruitment (millions of fish; middle panel), and fishing mortality (total biomass killed age 3+ / total biomass age 3+; bottom panel) for the sensitivity runs removing each index of abundance conducted for Gulf of Mexico Scamp.

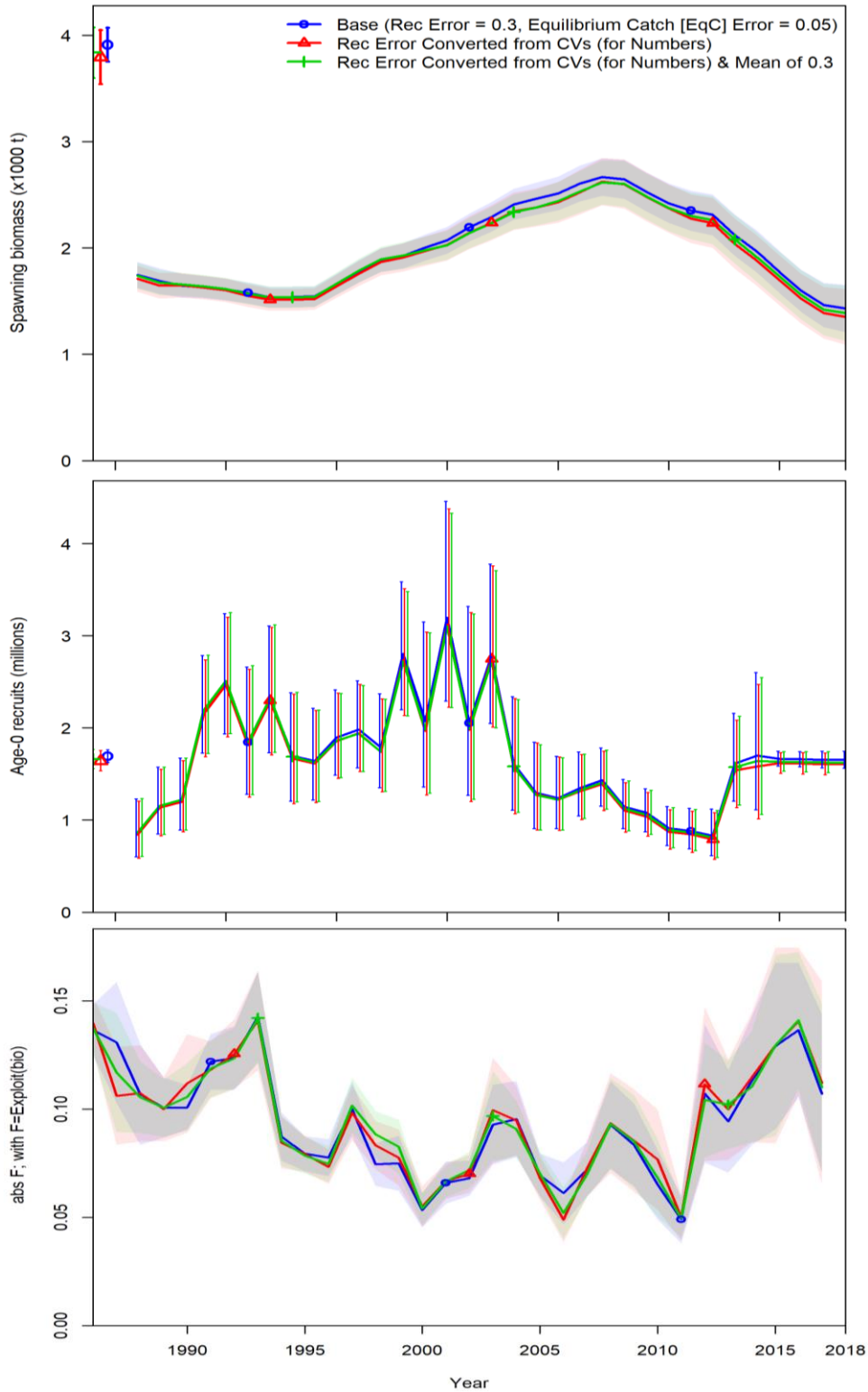

Figure 43. Estimates of spawning stock biomass (1,000s of metric tons; top panel), recruitment (millions of fish; middle panel), and fishing mortality (total biomass killed age 3+ / total biomass age 3+; bottom panel) for the sensitivity runs evaluating uncertainty in recreational landings conducted for Gulf of Mexico Scamp.

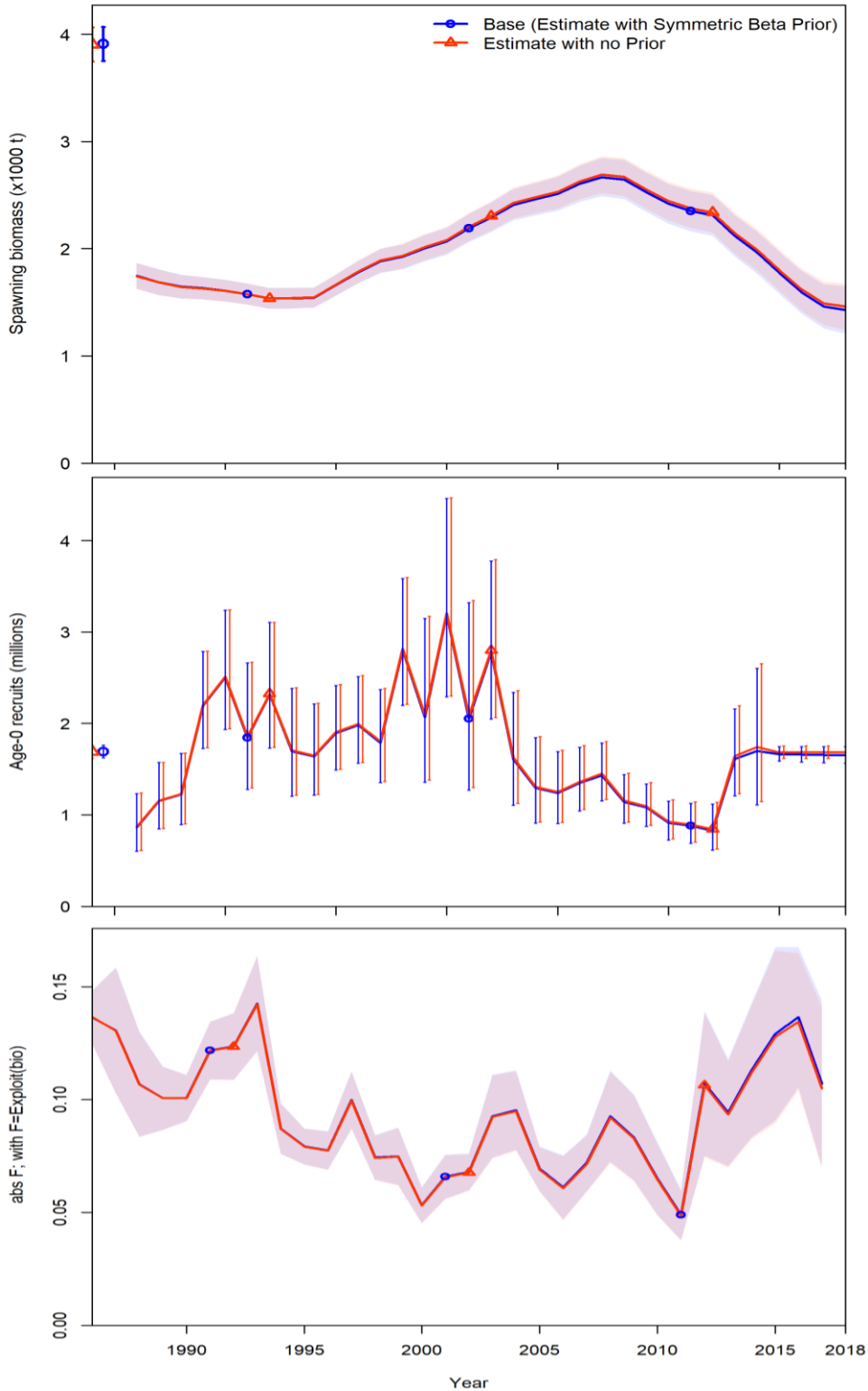

Figure 44. Estimates of spawning stock biomass (1,000s of metric tons; top panel), recruitment (millions of fish; middle panel), and fishing mortality (total biomass killed age 3+ / total biomass age 3+; bottom panel) for the sensitivity runs evaluating the estimation of steepness conducted for Gulf of Mexico Scamp.

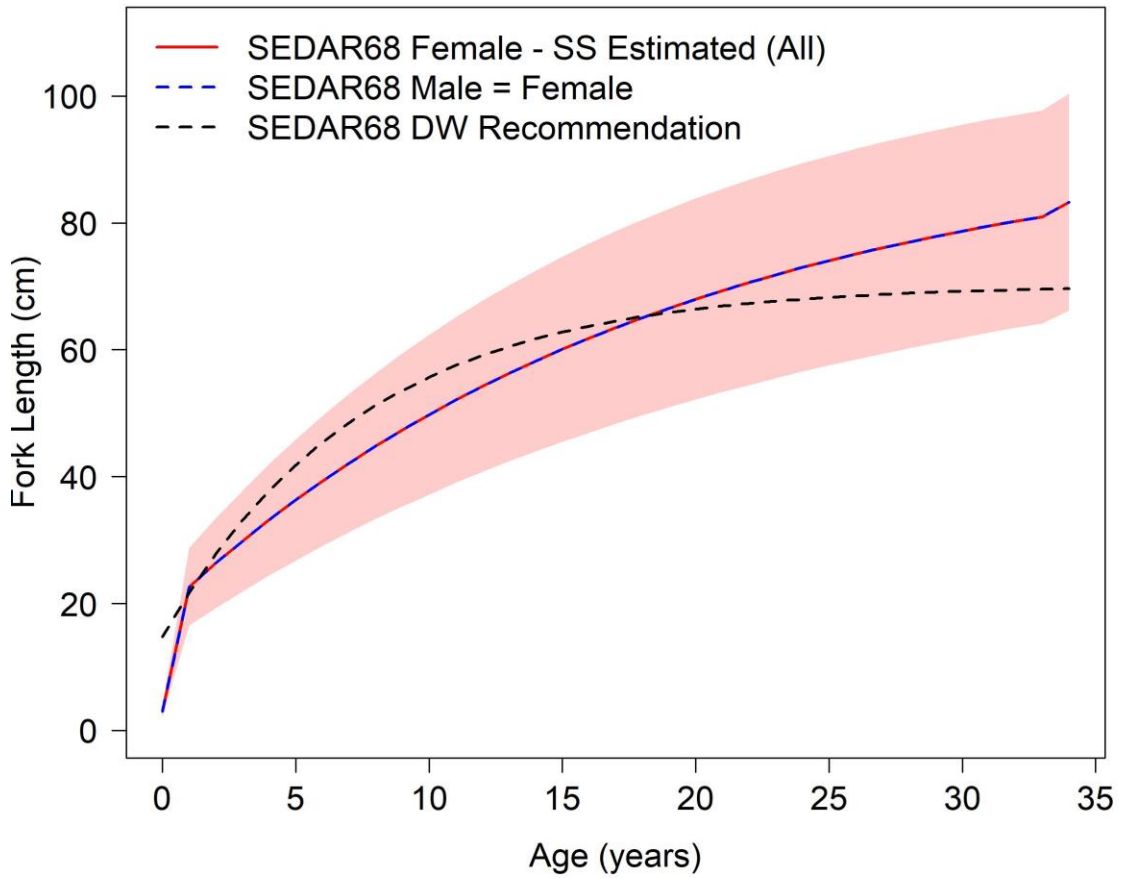

Figure 45. Comparison of recommended growth curve (black dashed line) and growth curves when estimating the growth parameters for Gulf of Mexico Scamp. The shaded area indicates the 95% distribution of length-at-age around the estimated growth curve.

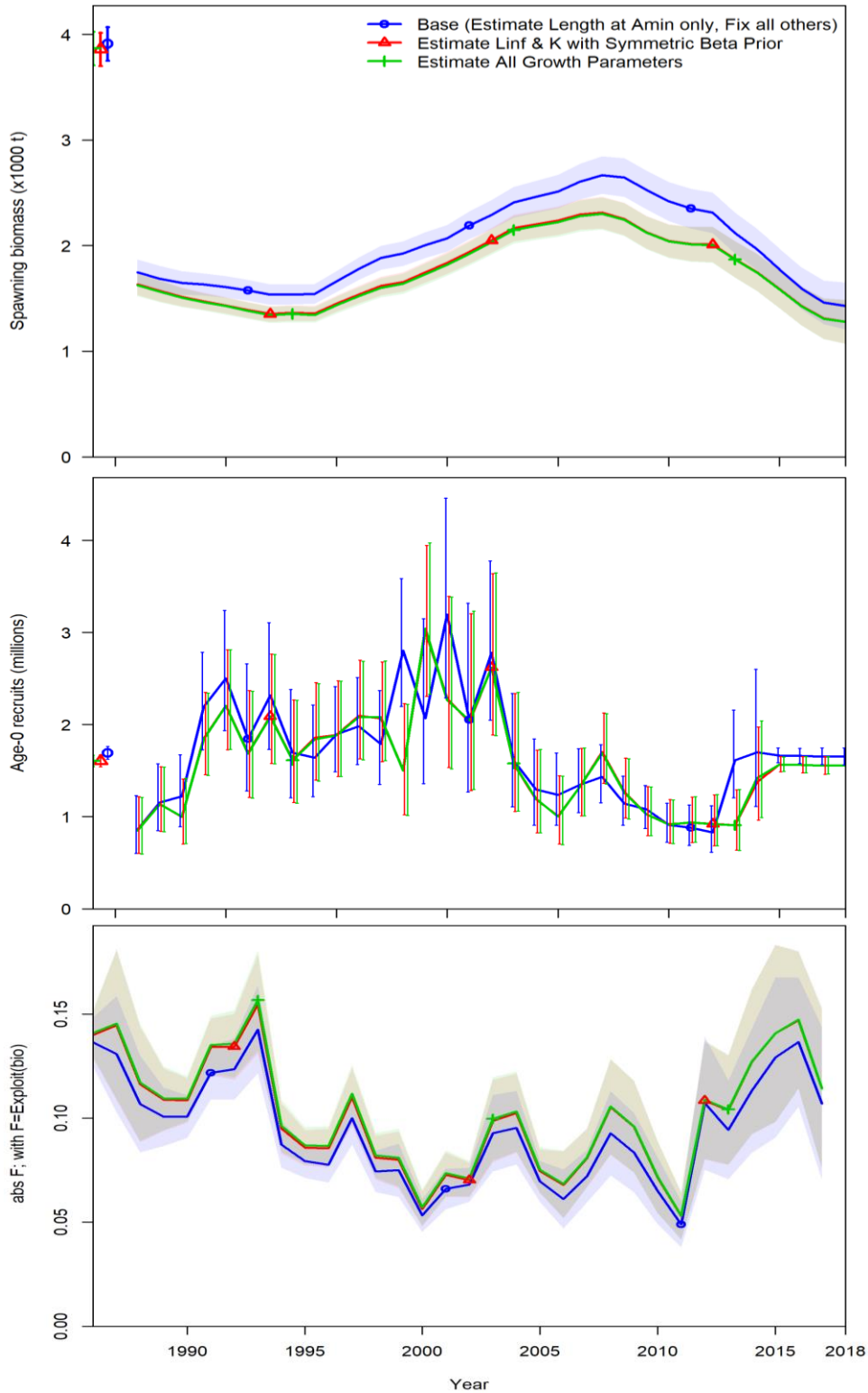

Figure 46. Estimates of spawning stock biomass (1,000s of metric tons; top panel), recruitment (millions of fish; middle panel), and fishing mortality (total biomass killed age 3+ / total biomass age 3+; bottom panel) for the sensitivity runs evaluating the estimation of growth conducted for Gulf of Mexico Scamp.

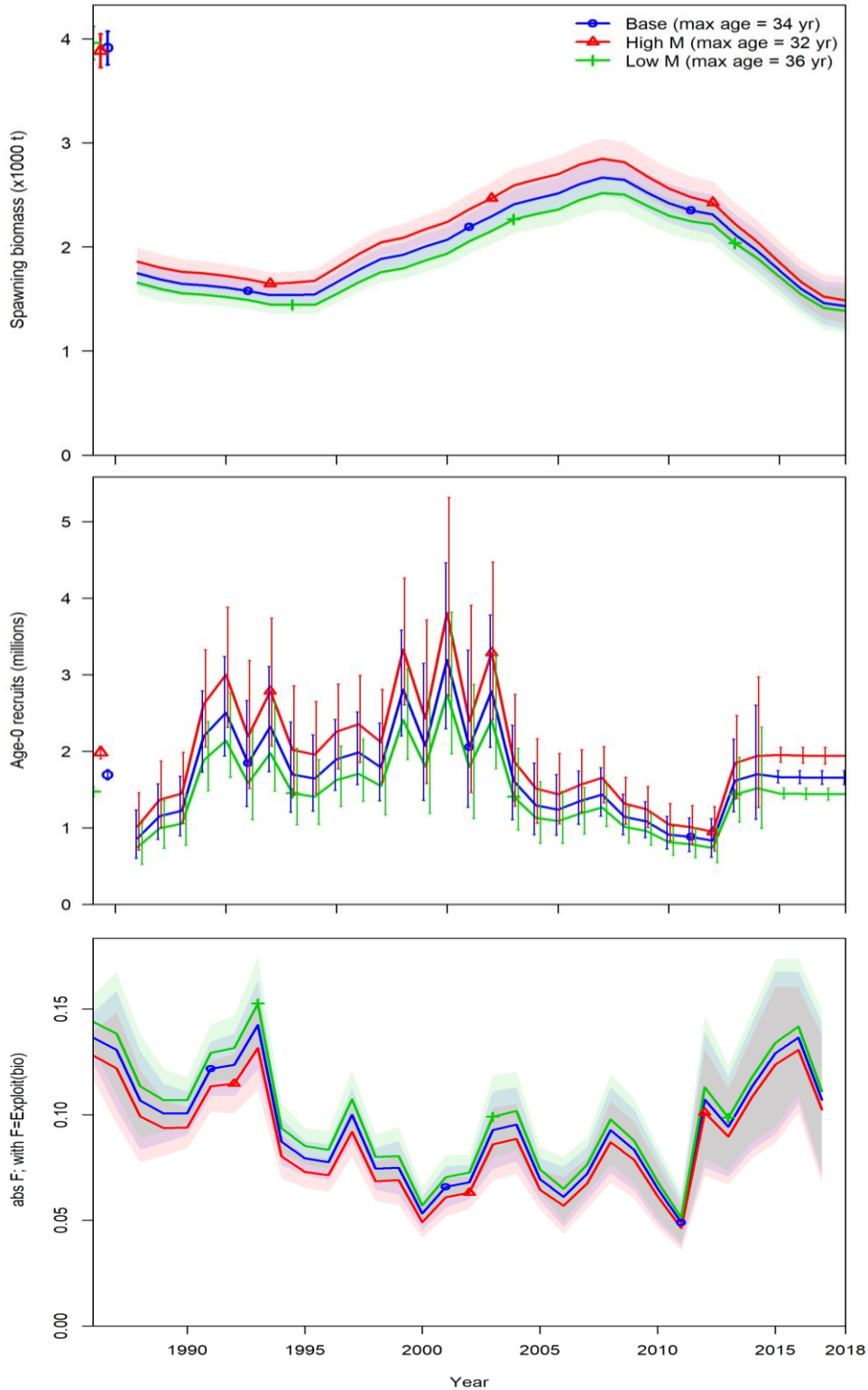

Figure 47. Estimates of spawning stock biomass (1,000s of metric tons; top panel), recruitment (millions of fish; middle panel), and fishing mortality (total biomass killed age 3+ / total biomass age 3+; bottom panel) for the sensitivity runs across natural mortality scenarios conducted for Gulf of Mexico Scamp.

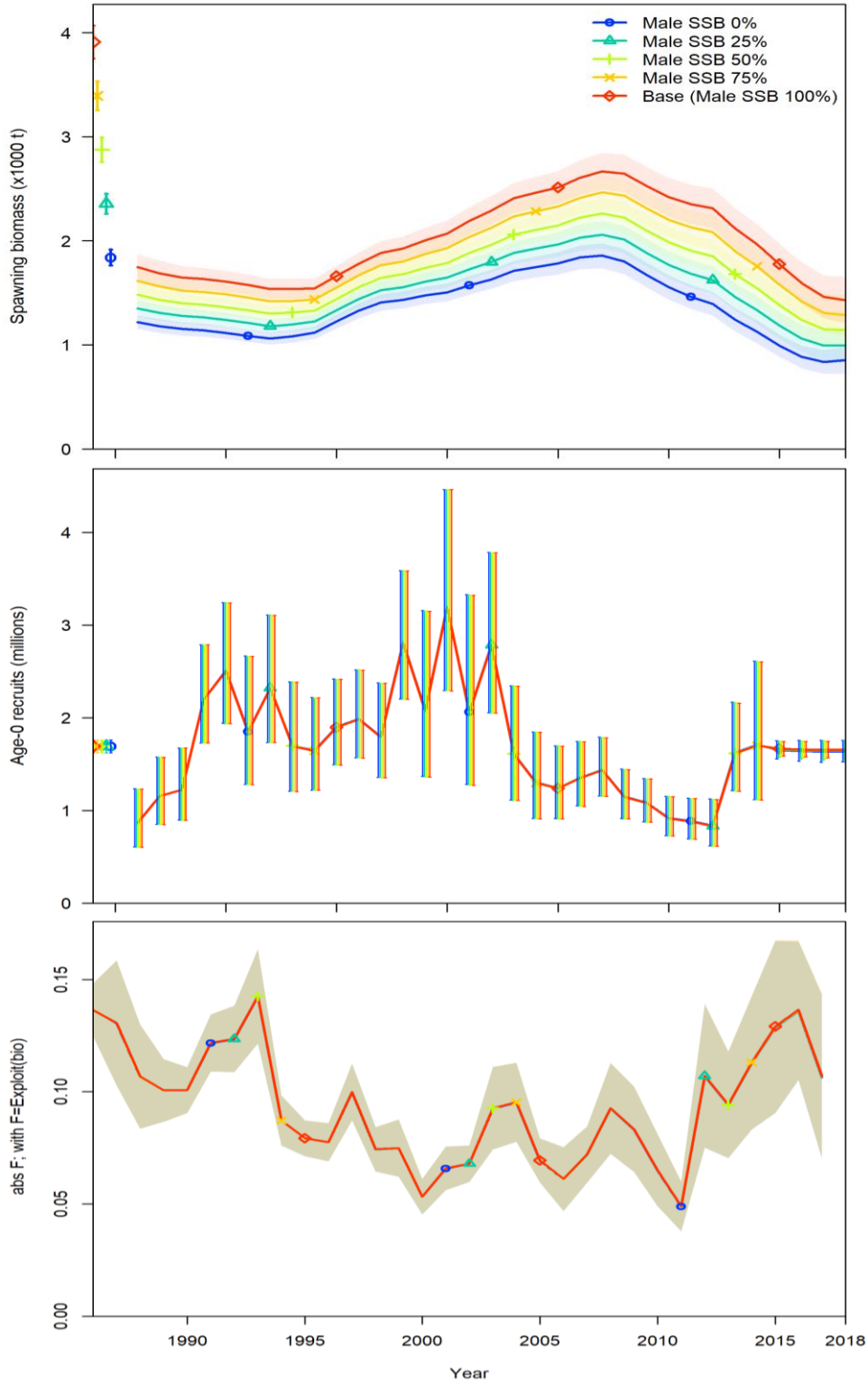

Figure 48. Estimates of spawning stock biomass (1,000s of metric tons; top panel), recruitment (millions of fish; middle panel), and fishing mortality (total biomass killed age 3+ / total biomass age 3+; bottom panel) for the sensitivity runs evaluating the contribution of Male SSB conducted for Gulf of Mexico Scamp Grouper.



SEDAR

Southeast Data, Assessment, and Review

SEDAR 68

Gulf of Mexico Scamp

SECTION IV: Research Recommendations

SEDAR
4055 Faber Place Drive, Suite 201
North Charleston, SC 29405

Table of Contents

1. DATA WORKSHOP RESEARCH RECOMMENDATIONS2
1.1 LIFE HISTORY RESEARCH RECOMMENDATIONS2
1.2 COMMERCIAL FISHERY STATISTICS RESEARCH RECOMMENDATIONS3
1.3 RECREATIONAL FISHERY STATISTICS RESEARCH RECOMMENDATIONS4
1.4 MEASURES OF POPULTAION ABUNDANCE RESEARCH RECOMMENDATIONS.....4
2. ASSESSMENT PROCESS RESEARCH RECOMMENDATIONS4
3. REVIEW PANEL RESEARCH RECOMMENDATIONS5

1. DATA WORKSHOP RESEARCH RECOMMENDATIONS

1.1 LIFE HISTORY RESEARCH RECOMMENDATIONS

Natural Mortality

- Convene a topical workgroup or other workshop to critically review literature used in Then et al. (2015), discuss recent advancements in ageing approaches (e.g., Gray Triggerfish), and propose best options for selecting species for inclusion in regression analyses for reef fish species in the US Southeast Region to be used in estimating natural mortality.
- Research the Thorson FishLife program for use in natural mortality estimates and measures of uncertainty. <https://github.com/James-Thorson-NOAA/FishLife>

Reproductive Biology

- Investigate the male contribution to spawning success and the potential for sperm limitation in the population through model simulations and field research that will fill in critical gaps in knowledge (i.e., fertilization rate under various sex ratio scenarios, mating strategy) and continue to monitor sex ratio.
- Additional sampling with better spatial and especially temporal coverage to confirm preliminary results that male gonadosomatic index (GSI) indicates that Scamp are spawning in pairs or small groups. This information is lacking for Yellowmouth Grouper.

- Collect all sizes of Yellowmouth Grouper and larger female Scamp (> 650 mm FL) during the spawning season to assess batch fecundity and thereby fill a data gap that prevents estimating total egg production.
- Given the likely smaller population size of Yellowmouth Grouper, samples with a wide range of size/age, from fishery-dependent and fishery-independent sources, are needed to determine reproductive parameters for this species and to allow comparisons with those of Scamp.

1.2 COMMERCIAL FISHERY STATISTICS RESEARCH RECOMMENDATIONS

- **Recommendation for the use of EM to facilitate the improvement of discard accounting in the South Atlantic**
 - The Center for Electronic Monitoring at Mote (CFEMM) has been applying Electronic Monitoring (EM) in the Gulf of Mexico (GoM) using Saltwater Inc. (SWI) software since 2016. EM is a valuable monitoring tool for researchers to directly observe and permanently document location, identify bycatch hotspots, catch, effort, and discard data to reduce uncertainty in critical finfish and shark fishery data for use by industry and management.
 - In the absence of a robust reef fish observer program in the South Atlantic, the commercial workgroup recognizes EM as a tool to improve discard accounting in the region. Additionally, the COVID-19 pandemic has hampered interactions between the fishing industry and state/federal fisheries data collections. The workgroup recognizes the potential for work pioneered by the CFEMM to advance biological sampling needs without human observers.
 - Continue to explore additional methods, such as citizen science (e.g. SAFMC Scamp Release), to help supplement information to characterize discard size composition
- **Recommendation for South Atlantic and Gulf of Mexico unified methodology in preparation of commercial landings**
 - The SEDAR 68 commercial workgroup has recognized that there are significant differences in the South Atlantic and Gulf of Mexico in the approach to the preparation of commercial landings. These differences were identified specifically in discussions of proportioning, validation, and data provision formats.

- In order to resolve the issue, the workgroup recommends that SEDAR staff convene and facilitate a joint-regional workshop for commercial workgroup members from both regions in order to follow-up on and confirm the best practices in Procedural Workshop 7.
- Previous workgroup leaders should be consulted in establishing the TORs for the workshop.
- The workshop should review past decisions made for various species and summarize best practices, which could greatly simplify the content needed within stock assessment reports (e.g., focus text on details specific to the species being assessed)
- **Recommendation for Expanding Reef Fish Observer Program Coverage to the South Atlantic**
 - Programmatic funding should be allocated to expand existing observer temporal and spatial coverage in the South Atlantic reef fish fishery. Observer coverage should be sufficient to provide for statistically rigorous discard estimation methods and to provide adequate discard size composition data for use in stock assessments.

1.3 RECREATIONAL FISHERY STATISTICS RESEARCH RECOMMENDATIONS

- Increase sampling of the recreational fishing fleet, particularly the charter boat and private angler sector, to improve discard data collection. Discard length data and discard mortality are two areas of importance that should be included.
- Continue to develop methods to provide uncertainty estimates around landings and discard estimates
- Investigate the implications of the MRIP imputed lengths and weighting factors for a range of data-rich to data-limited species, where the length frequency distributions become erratic

1.4 MEASURES OF POPULATION ABUNDANCE RESEARCH RECOMMENDATIONS

No recommendations were provided.

2. ASSESSMENT PROCESS RESEARCH RECOMMENDATIONS

- Develop methods to characterize length and age composition of scamp observed on videos from the SERFS fishery-independent survey.
- Implement a systematic age sampling program for both the recreational and commercial sectors.
- Better characterize reproductive parameters including age at maturity, batch fecundity, spawning seasonality, and spawning frequency. Mature male and female biomass was the measure of reproductive potential for scamp in the assessment, but may be biased if reproductive parameters vary significantly with size or age.
- Age-dependent natural mortality was estimated by indirect methods for this assessment of scamp. Mark-recapture approaches (conventional, telemetry, or close-kin) might make it possible to obtain direct estimates of natural mortality of scamp.
- Better characterize the movement dynamics of the stock and the potential for distribution shifts.

3. REVIEW PANEL RESEARCH RECOMMENDATIONS

The Review Panel supports the research recommendations identified by the Data and Assessment stages for the Gulf of Mexico and South Atlantic assessment processes.

In particular, the Review Panel supported:

- The recommendations to develop artificial intelligence approaches as well as additional automation for image processing and for reading and analysis of video, otoliths, gonad sections and other samples that contribute to scamp stock assessments.

The Review Panel further recommended the following short-term and long-term research needs.

(Short-term, within 6 months)

- Fleet-specific plots of the spatial distribution of the fisheries in both the Gulf and S. Atlantic could help interpret changes in length and age composition over time.
- Dockside sampling was not always randomly structured and in the past, sampling was opportunistic. Investigate modeling issues that may have occurred as a consequence of this.

- For the Gulf, investigate the apparent conflict between the von Bertalanffy model parameters estimated by the model and those provided by the Life History Working Group.
- Further investigation of size and age composition data in the South Atlantic is desirable. Consider “borrowing” length and age composition samples from the Gulf to address poorly sampled strata in the South Atlantic. This assumes that during the historical period, fishery regulations by fleet may have been comparable between the two management units.

(Longer-term)

- Conclude investigation of the taxonomic status of yellowmouth grouper. It has been deemed historically to be a separate species. There is a need to develop a time series of the proportion of yellowmouth grouper over time, perhaps by sampling the catch in the fishery independent series (chevron traps).
 - Further investigate changes in reporting of recreational landings from all data sources and how the changes contribute to imprecision in the series.
 - Consider the possibility that the ROV data collected by Lewis et al. (2020) could provide another fishery-independent abundance index in the Gulf (see [SEDAR 68 RD44: Changes in Reef Fish Community Structure Following the Deepwater Horizon Oil Spill](#) for a copy of their paper).
 - More age samples required for all fleets.
 - More effort should be given to formally evaluate and incorporate ecosystem considerations.
 - Hold a Best Practices Workshop to address how best to use weights or numbers for recreational harvest in assessment models. This is a much more complex issue than can be resolved in an assessment process.
- **If applicable, provide recommendations for improvement or for addressing any inadequacies identified in the data or assessment modeling. These recommendations should be described in sufficient detail for application, and should be practical for short-term implementation (e.g., achievable within ~6**

months). Longer-term recommendations should instead be listed as research recommendations above.

Additionally, the Review Panel recommends the following:

- The assessment reports could be strengthened by the inclusion of descriptions of the biology and the fishery that are important for the assessment, including information on how management of other species may have affected the fishery in question. For example, in the current case, it was not clear until a late stage of the document that scamp are not directly targeted in the fisheries.
- Move towards a model ensemble of different plausible configurations selected by hypothesis testing and weighed by a comprehensive diagnostic against performance criteria agreed beforehand which is developed to provide stocks status and management advice for both stocks. As best practice, and as a minimum, the ensemble should integrate the three main sources of uncertainty (process uncertainty, parameter uncertainty, and observation error) in the data.
- In these assessments *a priori* assumptions were made about the shape of the selection curve which, while reasonable, there does not seem to be any direct evidence for these fleets that the shape chosen is the right one.
- Currently the Beaufort Assessment Model does not support an option to model discards with a retention function and appears to require this catch category to be modelled as a separate fleet. This does not reflect the way the observations are collected and the model needs to be enhanced to allow discards to be modelled with a separate retention function for the fleet concerned. In addition, having the option in the Beaufort Assessment Model to model selectivity by length would be desirable in the future.
- In order to overcome the problem of changes of scale seen in the Gulf retrospectives a more robust way of expressing F and biomass over time would be to use ratio estimators such as B/B_{MSY} and F/F_{MSY} .

5. Provide recommendations on possible ways to improve the Research Track Assessment process.

- Recognizing that the Research Track process is new, further background on regarding how it differs from other past and present SEDAR assessments would have been helpful.
- Having the involvement of the Chair of Data Working Group could increase the efficiency of this stage of the review.
- We appreciate the inclusion of some ecosystem considerations in the Gulf assessment where red tide and the 2010 Deep Water Horizon oil spill could have important consequences for fisheries; however more effort should be given to formally evaluate and incorporate ecosystem considerations throughout the assessment process.
- Make assessment data and models fully available to panelist. Removing certain data due to confidentiality hinder the work of the reviewers and negatively affects its quality.

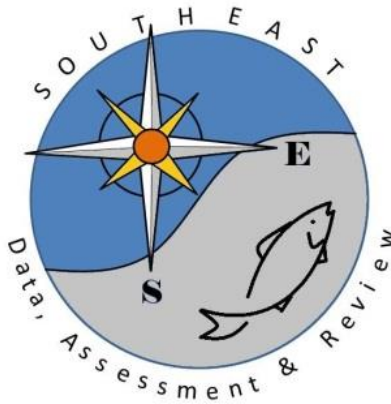

SEDAR

Southeast Data, Assessment, and Review

SEDAR 68

Gulf of Mexico Scamp

SECTION V: Review Workshop Report

September 2021

SEDAR
4055 Faber Place Drive, Suite 201
North Charleston, SC 29405

Table of Contents

Table of Contents 2

1. INTRODUCTION 2

 1.1 WORKSHOP TIME AND PLACE 2

 1.2 TERMS OF REFERENCE 2

 1.3 LIST OF PARTICIPANTS..... 3

 1.4 LIST OF REVIEW WORKSHOP WORKING PAPERS AND DOCUMENTS 4

2. REVIEW PANEL REPORT..... 4

1. INTRODUCTION

1.1 WORKSHOP TIME AND PLACE

The SEDAR 68 Review Workshop was held via webinar August 30 – September 3, 2021.

1.2 TERMS OF REFERENCE

1. Evaluate the data used in the assessment, including discussion of the strengths and weaknesses of data sources and decisions. Consider the following:
 - Are data decisions made by the DW and AW justified?
 - Are data uncertainties acknowledged, reported, and within normal or expected levels?
 - Is the appropriate model applied properly to the available data?
 - Are input data series sufficient to support the assessment approach?

2. Evaluate and discuss the strengths and weaknesses of the methods used to assess the stock, taking into account the available data. Consider the following:
 - Are methods scientifically sound and robust?
 - Are priority modeling issues clearly stated and addressed?
 - Are the methods appropriate for the available data?
 - Are assessment models configured properly and used in a manner consistent with standard practices?

3. Consider how uncertainties in the assessment, and their potential consequences, are addressed.
 - Comment on the degree to which methods used to evaluate uncertainty reflect and capture the significant sources of uncertainty in the population, data sources, and assessment methods.

- Comment on the likely relationship of this variability with possible ecosystem or climate factors and possible mechanisms for encompassing this into management reference points.
4. Provide, or comment on, recommendations to improve the assessment
 - Consider the research recommendations provided by the Data and Assessment workshops in the context of overall improvement to the assessment, and make any additional research recommendations warranted.
 - If applicable, provide recommendations for improvement or for addressing any inadequacies identified in the data or assessment modeling. These recommendations should be described in sufficient detail for application, and should be practical for short-term implementation (e.g., achievable within ~6 months). Longer-term recommendations should instead be listed as research recommendations above.
 5. Provide recommendations on possible ways to improve the Research Track Assessment process.
 6. Prepare a Review Workshop Summary Report describing the Panel’s evaluation of the Research Track stock assessment and addressing each Term of Reference.

1.3 LIST OF PARTICIPANTS

Workshop Panel

| | |
|------------------------------|-----------|
| Luiz Barbieri | GMFMC SSC |
| Massimiliano Cardinale | CIE |
| Robin Cook | CIE |
| Doug Gregory (Chair)..... | GMFMC SSC |
| Anne Lange | SAFMC SSC |
| John Neilson..... | CIE |
| George Sedberry | SAFMC SSC |

Analytic Team

| | |
|---|------------|
| Francesca Forrestal, Atlantic Lead Analyst | NMFS Miami |
| Skyler Sagarese, Gulf of Mexico Lead Analyst..... | NMFS Miami |
| Katie Siegfried | NMFS Miami |

Council Representation

| | |
|------------------|-------|
| Tim Griner | SAFMC |
|------------------|-------|

Attendees

| | |
|----------------------|--------------|
| Wally Bublely | SCDNR/MARMAP |
| Nancie Cummings..... | NMFS Miami |
| LaTresse Denson..... | NMFS Miami |
| Margaret Finch..... | SCDNR |
| Dawn Glasgow | SCDNR |

Seward McLean NCDENR
 Kyle Shertzer NMFS Beaufort
 Matt Smith NMFS Miami
 Michelle Willis..... SCDNR

Staff

Julie Neer SEDAR
 Chip Collier..... SAFMC Staff
 Judd Curtis SAFMC Staff
 Ryan Rindone..... GMFMC Staff
 Mike Schmidtke SAFMC Staff

1.4 LIST OF REVIEW WORKSHOP WORKING PAPERS AND DOCUMENTS

| Documents Prepared for the Review Workshop | | |
|---|--|----------------|
| Modeling of recreational landings in Gulf stock assessments | Gulf Branch – Sustainable Fisheries Division | 10 August 2021 |

2. REVIEW PANEL REPORT

Executive Summary

The SEDAR 68 Scamp Review Workshop was held virtually during the week of August 30 – September 3, 2021. Based on input from the Stock ID Panel, the Gulf of Mexico and South Atlantic scamp stocks were assessed separately. The Gulf of Mexico assessment was conducted with the Stock Synthesis model and the South Atlantic assessment was conducted with the Beaufort Assessment Model.

Although scamp is an important component of the southeastern U.S. grouper fisheries, it is not a targeted species, like the more common, red, black, and gag groupers. Consequently, both assessments were considered data moderate assessments with concomitant issues that could not be fully resolved.

The assessments were thoroughly conducted by the assessment team with transparent acknowledgement of challenges, uncertainties, and any unresolved issues. The models used were appropriate for the available data and the results and diagnostics were not unexpected given the challenges presented by this being a data moderate assessment. For example, non-random retrospective patterns were present in both assessments.

The primary challenges to these assessments were with the estimation of selectivity and growth parameters. A part of the problem could have been the inclusion of yellowmouth grouper, however minor, in the overall scamp catch, as well as the possible misidentification of larger fish, like warsaw grouper, as scamp. Also, South Atlantic scamp were not aged in the earlier years of the assessment time period and conversion of lengths to weight with a growth curve may have caused the selectivity problem observed in the assessment. Improvements are also needed in the Gulf ageing samples which are likely to be resolved in time for the Operational Assessment.

Overall, the final models (i.e., after incorporating modifications recommended by the review workshop panel) for both the Gulf of Mexico and South Atlantic scamp appear to be robust relative to the trends in spawning stock biomass and fishing mortality. Numerous scenarios were conducted by the assessment team and the review workshop panel. While fits to age and length compositions were not ideal and retrospective patterns could not be resolved, it is deemed that these issues are the result of the data moderate nature of this initial assessment of scamp and that little to no further improvements could be made to these assessments at this time.

Prior to conducting the operational assessments, uncertainties in length and age composition over time need to be further investigated. It may also be useful to evaluate the effects of including yellowmouth grouper and the larger, possibly misidentified, outlier fish on model fits to age and length compositions. Longer term, greater integration of environmental factors and ecosystem considerations in assessment models will be needed to help address climate change effects. It would also be helpful to move towards an ensemble modeling approach to integrate the main sources of uncertainty.

Terms of Reference

1. Evaluate the data used in the assessment, including discussion of the strengths and weaknesses of data sources and decisions. Consider the following:

- **Are data decisions made by the DW and AW justified?**

The comments provided below apply to both the Gulf and South Atlantic scamp assessments unless specified otherwise. The decision on the stock structure/management boundary was supported by the absence of fish movements between management jurisdictions and seemed pragmatic for management purposes until more data is available. Similarly, the decision to combine scamp and yellowmouth grouper landings seemed justifiable given the difficulty in species identification and the relatively small fraction of scamp landings thought to be yellowmouth. Despite the paucity of biological samples available for both regions, decisions on life history parameters such as growth, maturity and natural mortality were supported by appropriate analyses. For landings and CPUE information, decisions on the start of landings time series were made appropriately with respect to the availability of species-

specific data and considering the effects of significant management measures. Appropriate standardizations were used for fishery-dependent indices of abundance. Discard information was available for both the commercial and recreational fleets and used appropriately.

- **Are data uncertainties acknowledged, reported, and within normal or expected levels?**

Yes, data uncertainties are acknowledged, reported and within expected levels for both the Gulf and South Atlantic assessments. However, it should be noted that for both regions scamp are considered data moderate, meaning that significant data limitations exist both in terms of data quality and quantity. For the Gulf, annual estimates of recreational landings and discards were fixed at a higher standard error relative to that of the annual commercial landings. For the South Atlantic, both recreational and commercial landings were assigned annual coefficient of variations (CVs). For the Gulf, the lead analyst noted concerns about ageing error, especially for older fish. Concerns about age data from 2003-2012 led to the use of otolith weight as a proxy for age. Otoliths from that sample set will be reread and the data included in the upcoming operational assessment. There were relatively few length composition samples available in the earliest trimester of the South Atlantic assessment. The impact of aggregating yellowmouth and scamp, while thought to be slight, should be investigated further (see Research Recommendations below).

Some high CVs are associated with the annual mean weights for the charter/private and headboat sectors. Uncertainty in conversion of recreational landings from number to weight is considered an issue since allocations are based on weight. Very high CVs also were associated with some derived values, being substantially higher than the CVs of the input values.

- **Is the appropriate model applied properly to the available data?**

Yes, Stock Synthesis (SS) in the Gulf and the Beaufort Assessment Model (BAM) are standard models used in SEDAR assessments. Both models were appropriate for the respective data sets available to the analysts. Key advantages of these models include flexibility in estimation of time-varying selectivity, and, to the extent possible, accounting for imprecision of input data. These attributes are particularly important when developing a reliable operational assessment for management advice.

- **Are input data series sufficient to support the assessment approach?**

As mentioned above, Gulf and South Atlantic scamp are considered to be data-moderate stocks; however, the data series were sufficient to support the approach for both the Gulf and South Atlantic assessments. A number of data limitations and uncertainties were identified and improvements are needed, as recognized by the assessment team (see following list) and some are discussed in more detail under Research Recommendations.

Identified concerns include the following items.

- Improvements needed in age data, including more ages and rereading of some Gulf 2003-2012 otoliths which were determined to have errors in some age assignments.
- Changes in the Marine Recreational Information Program (MRIP) survey methods and pooling of a number of other recreational fisheries surveys contributed to imprecision in the series.
- Dockside sampling was not always randomly structured and in the past, some sampling was opportunistic. This is thought to have contributed to modeling issues, such as requiring conditional age-at-length data to be replaced with nominal commercial age compositions.
- Knowledge of the proportion of yellowmouth grouper over time was assumed to be small and non-varying over time.

2. Evaluate and discuss the strengths and weaknesses of the methods used to assess the stock, taking into account the available data. Consider the following:

- **Are methods scientifically sound and robust?**

Yes, the analysts' treatment of data sets used in the Gulf and South Atlantic assessments, the methods used to configure those data, and the application of the respective models was scientifically sound and robust.

- **Are priority modeling issues clearly stated and addressed?**

Yes, the analyses team did a good job explaining the issues. There are some modeling issues which require further investigation before the operational assessment.

- **Are the methods appropriate for the available data?**

Yes. There are relatively reliable landings, length and age compositions, and abundance indices. The methods used for each assessment were appropriate for the available data.

- **Are assessment models configured properly and used in a manner consistent with standard practices?**

Yes, the models for the Gulf and South Atlantic scamp, based on Stock Synthesis and the Beaufort Assessment Model, respectively, were configured properly and in a manner consistent with standard practices.

3. Consider how uncertainties in the assessment, and their potential consequences, are addressed.

- **Comment on the degree to which methods used to evaluate uncertainty reflect and capture the significant sources of uncertainty in the population, data sources, and assessment methods.**

Both assessments used a set of standard approaches to investigating uncertainty. These include examination of residual plots, likelihood profiles, sensitivity runs, retrospective analyses, and jitter analyses. In addition, for the Atlantic assessment, an ensemble modelling approach (Monte Carlo Bootstrap Ensemble) was undertaken. The panel thought this was an important step forward in quantifying uncertainty. It considers uncertainty in the catch and abundance indices as well as a number of constants used in the model such as natural mortality and discard survival and provides a more comprehensive insight into the overall uncertainty in the assessment. Nevertheless, the model diagnostic toolbox should be expanded to include, at a minimum, test runs of the residuals, retrospective and forecast Mohn's rho, hindcasting, and MCMC. Furthermore, a model ensemble needs to be developed that integrates the three main sources of uncertainty (process uncertainty, parameter uncertainty, and observation error). The challenge with this approach is to identify a manageable range of models to simulate that adequately consider plausible differences in population dynamics and fleet behavior.

The panel requested a number of runs of the assessments to examine specific issues.

For the Gulf scamp assessment requested runs included:

- Replacing the conditional age-at-length data with nominal commercial age compositions. Conditional age-at-length assumes each age observation is random but the analyst found, through the Trip Interview Program, that at least some samples were not random.
- Removing all the Reef Fish Observer Program (RFOP) index data as this survey appeared to show a conflicting trend compared with all other indices.
- Including only the Video and RFOP indices/compositions to illustrate the impact of the RFOP in the absence of the other fishery dependent indices. The video survey is regarded as the preferred fishery independent index so was retained.
- Creating a length plus group bin at 84 or 75 cm to examine the sensitivity of the model to choice of accumulator bin since most fish in the samples are below the base model maximum bin size. This generally improves the estimation of the selectivity parameters, especially the descending part of a double normal.
- Setting an upper bound for the Dirichlet multinomial at 5 as recommended by the Stock Synthesis manual.
- Fixing the Dirichlet parameters that are estimated at the upper bound as this has no impact on the model estimation but reduces the number of model parameters (i.e. increased parsimony).

Overall, the results of the sensitivity runs presented in the Assessment Report and the additional runs performed during the review workshop suggested that the overall

qualitative trend in the estimated biomass and fishing mortality were similar. The various sensitivity configurations did, however, impact the scale of the biomass and the rate of biomass decline in recent years. Removal of the RFOP survey, for example, suggests a greater decline in biomass as this survey, in contrast to all the others, has an increasing trend in recent years.

The jitter analysis for the base run in the Assessment Report showed that the objective function has a poorly defined minimum with a large number of runs failing to converge but no run having a smaller log likelihood than the base run. Estimated biomass and fishing mortality remained similar across jitter of runs that converged, although, a number of the model parameters relating to selectivity differed. This points to some parameters having substantial uncertainty. However, while this does not impact the trend in spawning stock biomass and fishing mortality it may have implications for reference point estimation and forward projections.

The Review Panel final base model for Gulf scamp included the following changes to the original base model:

- Input recreational landings in numbers and fit to mean weight of landed fish for recreational fleets.
- Increase starting fishing mortality standard error for headboats from 0.01 to 0.05.
- Input commercial age composition instead of conditional age-at-length as these provide a better model fit.
- Estimate an extra standard deviation parameter for each index to allow poorly fit surveys to be downweighted.
- Create a length plus group bin = 84 cm fork length to obtain a better fit to the length compositions and improve estimates of selectivity.
- Set an upper bound for the Dirichlet multinomial at 5, and fix Dirichlet parameters that are at the upper bound.
- Natural mortality adjustment to account for pre-recruit mortality.
- Estimate the inflection point for fishery retention curves to obtain a better model fit.
- Fix steepness at 0.69. This is a weighted mean of the estimate from FishLife and the South Atlantic estimate in the current assessment. This value was used since steepness could not be estimated within the model.

For the South Atlantic Scamp assessment requested additional runs included:

- Combining dead discards with landings to avoid modelling separate fleets for each catch component and improve parsimony given that discards account for only a very small fraction of the catch.

- Theoretical works have shown that selectivity in models like the Beaufort Assessment Model (i.e. based on gear selectivity plus fish availability) are typically dome shaped but the extent of the dome might vary. Thus, selectivity for the recreational and commercial sectors was requested to be modelled with a double normal, which does not *a priori* impose any particular shape to the selectivity function and allow parameters and shape to be determined by the data.
- Removing the two time blocks, as well as increasing them to six time blocks to investigate the apparently inconsistent selection patterns in each block. Here the later period selection pattern is expected to lie to the right of the early period but the base model estimates the reverse. The underlying issues may be due to an absence of direct ageing in the earlier years of the assessment.
- Including an ageing error matrix selectivity as there is evidence of uncertainty in age determination especially in older fish.

In common with the Gulf assessment, the results of the sensitivity runs presented in the Assessment Report and the additional runs performed during the review workshop suggested that the overall qualitative trend in the estimated biomass and fishing mortality were similar. However, removal of time blocks resulted in a greater decline in estimated biomass and a much reduced estimate of steepness which the panel felt was unrealistic. While the inclusion of time blocks improved the estimate for steepness, the estimated selectivity for each block was apparently not consistent with the change in the size regulations for which the blocks were designed. However, at least part of this disparity was partially attributed to compliance being based on total length while the model was run with fork lengths.

The assessment is heavily conditioned on the commercial landings data as these are assumed to have very low observation error. Relaxing this assumption has some impact on the model results. However, for the time being, the final base model assumes a low observation error for commercial landings.

The Review Panel final base model for South Atlantic scamp included the following changes to the original base model:

- Combined dead discards with landings.
- Used dome shaped selectivity for recreational and commercial sectors.
- Retained time blocks in the final model because their removal resulted in unusually low estimates of steepness.
- **Comment on the likely relationship of this variability with possible ecosystem or climate factors and possible mechanisms for encompassing this into management reference points.**

Apart from a comparison of areas of hypoxia associated with red tide events and the spatial distribution of scamp in the Gulf of Mexico, a comprehensive examination of ecosystem or climate related factors on scamp productivity was not undertaken. However, the Panel noted that work is ongoing to describe system dynamics for Gulf and South Atlantic scamp populations. This work should generate plausible hypotheses for incorporation of ecosystem considerations in the assessment process.

A recent climate vulnerability assessment for South Atlantic scamp has rated the species Very High in Overall Climate Vulnerability, because of climate change threats to its habitat and prey species, and its narrow temperature preferences.

Scamp is an included species in the South Atlantic Region Ecosystem Diet Model for the Ecopath with Ecosim Model of the South Atlantic Region. This model offers promise for inclusion of additional ecosystem parameters in future stock assessments for scamp.

4. Provide, or comment on, recommendations to improve the assessment.

- **Consider the research recommendations provided by the Data and Assessment workshops in the context of overall improvement to the assessment, and make any additional research recommendations warranted.**

The Review Panel supports the research recommendations identified by the Data and Assessment stages for the Gulf of Mexico and South Atlantic assessment processes.

In particular, the Review Panel supported:

- The recommendations to develop artificial intelligence approaches as well as additional automation for image processing and for reading and analysis of video, otoliths, gonad sections and other samples that contribute to scamp stock assessments.

The Review Panel further recommended the following short-term and long-term research needs.

(Short-term, within 6 months)

- Fleet-specific plots of the spatial distribution of the fisheries in both the Gulf and S. Atlantic could help interpret changes in length and age composition over time.
- Dockside sampling was not always randomly structured and in the past, sampling was opportunistic. Investigate modeling issues that may have occurred as a consequence of this.
- For the Gulf, investigate the apparent conflict between the von Bertalanffy model parameters estimated by the model and those provided by the Life History Working Group.
- Further investigation of size and age composition data in the South Atlantic is desirable. Consider “borrowing” length and age composition samples from the Gulf to address poorly sampled strata in the South Atlantic. This assumes that during the

historical period, fishery regulations by fleet may have been comparable between the two management units.

(Longer-term)

- Conclude investigation of the taxonomic status of yellowmouth grouper. It has been deemed historically to be a separate species. There is a need to develop a time series of the proportion of yellowmouth grouper over time, perhaps by sampling the catch in the fishery independent series (chevron traps).
 - Further investigate changes in reporting of recreational landings from all data sources and how the changes contribute to imprecision in the series.
 - Consider the possibility that the ROV data collected by Lewis et al. (2020) could provide another fishery-independent abundance index in the Gulf (see [SEDAR 68 RD44: Changes in Reef Fish Community Structure Following the Deepwater Horizon Oil Spill](#) for a copy of their paper).
 - More age samples required for all fleets.
 - More effort should be given to formally evaluate and incorporate ecosystem considerations.
 - Hold a Best Practices Workshop to address how best to use weights or numbers for recreational harvest in assessment models. This is a much more complex issue than can be resolved in an assessment process.
- **If applicable, provide recommendations for improvement or for addressing any inadequacies identified in the data or assessment modeling. These recommendations should be described in sufficient detail for application, and should be practical for short-term implementation (e.g., achievable within ~6 months). Longer-term recommendations should instead be listed as research recommendations above.**

Additionally, the Review Panel recommends the following:

- The assessment reports could be strengthened by the inclusion of descriptions of the biology and the fishery that are important for the assessment, including information on how management of other species may have affected the fishery in question. For example, in the current case, it was not clear until a late stage of the document that scamp are not directly targeted in the fisheries.
- Move towards a model ensemble of different plausible configurations selected by hypothesis testing and weighed by a comprehensive diagnostic against performance criteria agreed beforehand which is developed to provide stocks status and management advice for both stocks. As best practice, and as a minimum, the ensemble should integrate the three main sources of uncertainty (process uncertainty, parameter uncertainty, and observation error) in the data.

- In these assessments *a priori* assumptions were made about the shape of the selection curve which, while reasonable, there does not seem to be any direct evidence for these fleets that the shape chosen is the right one.
- Currently the Beaufort Assessment Model does not support an option to model discards with a retention function and appears to require this catch category to be modelled as a separate fleet. This does not reflect the way the observations are collected and the model needs to be enhanced to allow discards to be modelled with a separate retention function for the fleet concerned. In addition, having the option in the Beaufort Assessment Model to model selectivity by length would be desirable in the future.
- In order to overcome the problem of changes of scale seen in the Gulf retrospectives a more robust way of expressing F and biomass over time would be to use ratio estimators such as B/B_{MSY} and F/F_{MSY} .

5. Provide recommendations on possible ways to improve the Research Track Assessment process.

- Recognizing that the Research Track process is new, further background on regarding how it differs from other past and present SEDAR assessments would have been helpful.
- Having the involvement of the Chair of Data Working Group could increase the efficiency of this stage of the review.
- We appreciate the inclusion of some ecosystem considerations in the Gulf assessment where red tide and the 2010 Deep Water Horizon oil spill could have important consequences for fisheries; however more effort should be given to formally evaluate and incorporate ecosystem considerations throughout the assessment process.
- Make assessment data and models fully available to panelist. Removing certain data due to confidentiality hinder the work of the reviewers and negatively affects its quality.

6. Prepare a Review Workshop Summary Report describing the Panel's evaluation of the Research Track stock assessment and addressing each Term of Reference.

This report fulfills the requirement of this Term of Reference.

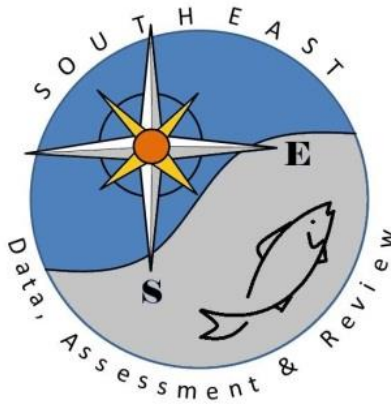

SEDAR

Southeast Data, Assessment, and Review

SEDAR 68

Gulf of Mexico Scamp Grouper

SECTION VI: Post-Review Workshop Addendum Report

September 2021

SEDAR
4055 Faber Place Drive, Suite 201
North Charleston, SC 29405



SEDAR 68 Gulf of Mexico Scamp Grouper Research Track Assessment - Addendum

Gulf Branch
Sustainable Fisheries Division
NOAA Fisheries - Southeast Fisheries Science Center

September 2021

Table of Contents

| | |
|---|----|
| 1. Introduction..... | 2 |
| 2. Clarifications..... | 2 |
| 3. Initial sensitivity runs..... | 4 |
| 3.1 Recreational landings input..... | 4 |
| 3.1.1 Commercial age compositions..... | 5 |
| 3.1.2 Remove Reef Fish Observer Program Vertical Line Survey..... | 5 |
| 3.1.3 Remove pre-IFQ Commercial Vertical Line and Recreational Headboat Indices | 6 |
| 3.1.4 von Bertalanffy asymptotic length, maximum length, and length bins | 7 |
| 3.1.5 Dirichlet multinomial parameters | 7 |
| 4. Alternative model structure (SEDAR 68 RW Base Model)..... | 7 |
| 4.1. Input landings in numbers and fit to mean body weight for each recreational fleet..... | 8 |
| 4.2. Include all indices of abundance and estimate an extra SD parameter for each..... | 8 |
| 4.3. Input and fit to nominal commercial age compositions..... | 8 |
| 4.4. Increase the standard error (SE) for the starting F value for the Recreational Headboat fleet from 0.01 to 0.05..... | 8 |
| 4.5. Bin all length data for Scamp 84 cm FL or larger | 9 |
| 4.6. Set the upper bound of each Dirichlet parameter at 5..... | 9 |
| 4.7. Fix steepness at biologically plausible value | 9 |
| 4.8. Adjust natural mortality vector | 9 |
| 4.9. Estimate inflection points for each fishery retention curve | 10 |
| 4.10. Fix Dirichlet parameter(s) being estimated at the upper bound..... | 11 |
| 5. Alternative model structure and comparison to the SEDAR 68 AP Base Model..... | 11 |

5.1. Derived quantities 11

5.2. Model fits 12

5.3. Diagnostics..... 13

5.3.1. Diagnostics from Assessment Process..... 13

5.3.2. SS3 diagnostics following Carvahlo et al. (2021) 13

5.3.3. Sensitivity runs..... 15

6. Further investigations warranted..... 16

6.1 Estimation of growth..... 16

6.2 Selectivity and retention 16

6.3 Retrospective bias 16

7. Other issues discussed but not pursued further during the RW 16

8. References 17

9. Tables 19

10. Figures..... 30

11. Appendix: SEDAR 68 RW Base Model..... 89

11.1 SEDAR 68 RW Base Model Tables 89

11.2 SEDAR 68 RW Base Model Figures..... 128

1. Introduction

The SEDAR 68 Scamp Assessment Review Workshop (RW) took place August 30-September 3, 2021 virtually. During the RW, the SEDAR 68 RW Panel revisited discussions and decisions made during the Data Workshop (DW) and Assessment Process (AP) Webinars and requested additional details or analyses from the analytical team. Below is a summary of those requests.

2. Clarifications

Hermaphroditism in Stock Synthesis (SS) and derived sex ratios

There was some discussion regarding how Stock Synthesis (SS) models the transition of female to male Scamp. For each age class 3 years or older, a Scamp may or may not transition into male, with the probability of transitioning to a male at each age class modeled using a cumulative normal function. SS requires three parameters which define the conditional probability of transition, conditional on a Scamp being female. To derive the parameters defining the probability of transition, first a cumulative normal distribution is fit to obtain the observed proportion male at age on the data set provided by the Life History Working Group (**Table 8** in SEDAR68-DW28). The oldest female Scamp was 19 years old, although only 25 individuals 20 years or older were collected. Next the inflection point and standard deviation (SD) parameters are solved for which best fit the observed proportions male (21.525, 10.141). The third parameter specifying the inflection point is the estimated probability of transition for the plus group for the

population (maximum probability = 0.891). SS converts the numbers at age into female and male components using this transition curve at the end of each season (after mortality), and annual sex ratios are a derived quantity out of SS.

Reason for lack of projections in Gulf of Mexico report

In situations where MSY is not estimable for Gulf of Mexico stocks, stock status comes from projections which achieve a pre-specified spawner-per-recruit (SPR) level under equilibrium while making assumptions regarding population dynamics and fishing practices into the future. Given the research track nature of this assessment, more analytical time was dedicated to sensitivity runs and model diagnostics than development of projections. Further, projection specifications were not prescribed in the terms of reference, for example which MSY proxy to use nor how to treat recruitment during the projections. The RW Panel did not make suggestions as to what MSY proxy would be most appropriate for the stock.

Ensemble modeling in the Gulf of Mexico

Traditionally, catch advice derived from stock assessments in the Gulf of Mexico has been based on a single model run selected following review of model diagnostics. Numerous sensitivity runs are often run that cover different data treatments or assumptions behind model configuration, which help to highlight potential changes in key estimated parameters or derived quantities such as spawning stock biomass (SSB) or fishing mortality (F). Ensemble modeling could help alleviate the reliance on one single model (note that no model is 100% correct), but this would be a heavy lift under the current SEDAR assessment schedule and process. A full suite of diagnostics would need to be run on each model, which would greatly increase the time required. Additional resources aimed at either automating diagnostic procedures or increased computing power could help to implement an ensemble modeling approach in our region.

Productivity between Scamp and Yellowmouth Grouper

The RW Panel requested additional details concerning the species composition of data inputs and potential similarities in productivity between species. Of the data submitted for SEDAR 68, and for which species information was provided, Yellowmouth Grouper made up 4% of the age data submitted, 1% of commercial discards (0% of discard length compositions), and 0.1% of Recreational Charter Private discards. Preliminary Recreational Headboat index development revealed a very small percent positive of 0.09 (%) for Yellowmouth Grouper. Only 52 Yellowmouth Grouper were included in the Combined Video Survey (SEDAR68-DW-07), most of which were collected by the SEAMAP Video Survey in the western Gulf of Mexico (SEDAR68-DW-14). However, reported percentages may not be accurate due to species misidentification detailed in SEDAR68-SID-05.

Priors for steepness for each species were obtained using a multivariate normal age-structured Monte-Carlo simulation approach (Winker et al. 2020) combined with FishLife (Thorson et al. 2017). These estimates were 0.7777 (CV = 0.27) for Scamp and 0.7883 (CV = 0.28) for Yellowmouth Grouper.

ROV information

Data from the remotely operated vehicle (ROV) survey covering the northern Gulf of Mexico from 2009 through 2017 were not reviewed by the SEDAR 68 Index Working Group.

Fishing mortality estimation approach

The SEDAR 68 AP Base Model used F method 2 in SS which treats F as parameters. This approach uses the standard Baranov catch equation and lets ADMB find the apical fishing mortality parameter values that produce the lowest negative log-likelihood (NLL). This process includes fits to the input catch data, which are assigned a log-scale standard error (SE), and expected landings which are a function of the model parameters (and not constraints). This approach does not reproduce the input catch levels exactly, which was evident in fits to the recreational landings. This approach for calculating F is preferred for situations with high F and where catch is known imprecisely, such as for recreational fleets in the Southeast US.

Fitted landings and discards exhibiting more variability than observed data

The RW Panel was perplexed that some data streams showed more variability in expected values than in observed values. For example, the landings and discard data exhibited more variance in fitted values than in the input values. This was particularly true for the Recreational Charter Private, where landings were given a relatively large input log-scale SE of 0.3. In this instance, the predicted landings can be influenced by other data streams in the model. In the case of discards, large uncertainty can also lead to lack of fit and more variability, particularly since predicted discards are influenced by the landings because of the shared F and connection through the retention function.

3. Initial sensitivity runs

The RW Panel requested sensitivity runs on high priority issues discussed below. All sensitivity runs discussed in this section were built off of the model described in **Section 3.1**.

3.1 Recreational landings input

At the request of the analytical team, the RW revisited the Assessment Development Team (ADT) decision of how to input recreational landings into the assessment model based on the options detailed in SEDAR68-RW-01. Two key questions include: (1) whether to input recreational landings in numbers of fish (i.e., native units of collection by recreational surveys) or in weight (used for monitoring) and (2) whether to fit to the mean body weight of Scamp landed by each recreational fleet or use it as a check (i.e., include but do not fit to it and exclude from the likelihood). The RW Panel acknowledged the importance of this decision from a management perspective (i.e., for consistency with units used for monitoring), but emphasized that there were more important modeling issues to focus their attention on during the RW.

Results: Inputting recreational landings in numbers and fitting to mean body weight of Scamp landed by each recreational fleet led to no parameters bounding but one additional recruitment deviation with a CV exceeding 1 (i.e., highly uncertain; **Table 1**). Virgin SSB and annual SSB estimates were consistently lower, with SSB since about 2012 falling outside the uncertainty bounds of the SSB predicted by the SEDAR 68 AP Base Model (**Table 1; Figure 1**). These changes were largely driven by higher estimated F in more recent years and lower estimated F in the first few years of the time series (**Figure 1**). Recruitment estimates were similar for most years until 2003 where the SEDAR 68 AP Base Model estimated larger recruitments (**Figure 1**). This run estimated slightly higher steepness (0.961 vs 0.949) and lower $\text{Ln}(R_0)$ (7.433 vs 7.357), but similar recruitment variability (**Table 1**). For each recreational fleet, the mean body weight

of landed Scamp expected by the assessment model fell within the uncertainty bounds of the observed mean weight, suggesting acceptable fits to mean body weight (**Figures 2-3**). However, the expected mean body weight was less variable compared to the observed mean body weight.

3.1.1 Commercial age compositions

At the request of the analytical team, the RW also revisited the ADT decision to use conditional age-at-length (CAAL) for the commercial fisheries after additional information was obtained by the analytical team following the AP. While the use of CAAL is considered best practices for integrated assessment models when data allow, the validity of this approach is contingent upon the assumption that each age observation is a random sample from the population for a given length bin. The analytical team recently learned that sampling has been opportunistic during some of the time period, and therefore likely violates the assumptions for using CAAL. This issue was also discussed more recently during the SEDAR72 Gulf of Mexico Gag Grouper assessment, which also reverted back to using nominal age compositions for the commercial fleets (SEDAR 2021b). Given the tradeoff in fitting age and length compositions in the SEDAR 68 AP Base Model, in conjunction with concerns over growth estimation, the RW Panel reviewed a run fitting to nominal age compositions for the commercial fleets (instead of CAAL).

Results: Inputting nominal commercial age compositions led to the bounding of the parameter controlling the width of the 1990-1999 retention curve for the Commercial Longline fleet and a few more recruitment deviation parameters exhibited CVs exceeding 1 (**Table 1**). This data change led to considerable differences in estimated recruitment events, particularly for peak recruitment years in the late 1990s and early 2000s (**Figure 1**). Estimates of virgin SSB and recruitment were slightly lower than the SEDAR 68 AP Base Model, whereas estimates of steepness and recruitment variability were slightly higher (**Table 1**). Although this run exhibited higher SSB and lower F in the early years, most years remained within the uncertainty bounds (**Figure 1**). This run led to similar fits to aggregated length compositions (**Figure 4**) and aggregated recreational age compositions (**Figure 5**), but continued to show trade-offs between fitting both data types simultaneously.

3.1.2 Remove Reef Fish Observer Program Vertical Line Survey

A considerable amount of time during the RW was spent discussing this observed index because its trend was in clear conflict to the trend exhibited by the fishery-independent Combined Video Survey. The Combined Video Survey index is considered the most reliable index of abundance for this species because it covers key Scamp habitat, particularly since 2010 when FWRI began sampling off Florida where landings are highest. The RW Panel first requested a sensitivity run excluding the index and length data associated with this data stream. The justification was to see whether its exclusion led to better model diagnostics, as the RW Panel was concerned that its inclusion was having unintended impacts on the model output. Of particular concern was the assumed representativeness of the index in tracking the Scamp population (i.e., if both the Combined Video Survey and RFOP Vertical Line Survey are trusted indices, how can they be telling a different story?) and potential changes in catchability or fishing power over time (i.e., technology creep).

Results: After removing the RFOP Vertical Line Survey data, the initial model run did not converge due to a large gradient (0.025) attributed to the 1986 F parameter for the Recreational

Headboat fleet (**Table 1**). After adjusting the standard error (SE) for the starting F value for the Recreational Headboat fleet from 0.01 to 0.05, the model converged to one the lowest gradients observed for Scamp during model development (**Table 1**). SSB and recruitment trajectories were similar, although some shifts in F trajectories were noted such as lower F early on and higher F in more recent years compared to the SEDAR 68 AP Base Model (**Figure 1**). Estimates of virgin SSB and recruitment were slightly lower than the SEDAR 68 AP Base Model, whereas estimates of steepness and recruitment variability (σ_R) were slightly higher (**Table 1**). Review of SS3 diagnostics (described in **Section 5.3.2**) did not reveal any major improvements.

3.1.3 Remove pre-IFQ Commercial Vertical Line and Recreational Headboat Indices

The RW Panel discussed the Recreational Headboat index in relation to the size of Scamp landed by the fishery (i.e., smaller compared to the Recreational Charter Private fleet, **Figures 2-3**) and the recent decline. Concerns were raised regarding the sharp decline following 2010 and whether that was reflective of a decline in the population or in the behavior of the fishery. Insights from the fishery revealed a recent change in how the fishery operates, with effort shifting to shorter trips and closer to shore in more recent years. The Southeast Regional Headboat Survey dataset does not include latitude/longitude or depth measurements for consideration during the standardization process, but does include trip type (i.e., the duration of the trip) which can be used as a proxy for where fishing occurred. This factor was not significant during development of the Recreational Headboat index and therefore excluded from the standardization process (SEDAR68-DW-18). The removal of this index was covered in the jack-knife analysis documented in the SEDAR 68 AP Report (see **Section 4.8.5**).

The utility of the Pre-Individual Fishing Quota (IFQ) Commercial Vertical Line Index was also discussed by the RW Panel because of concerns over the lack of consideration of changes in fishing power. While this index was relatively flat throughout the time period, additional analyses by the RW Panel did show that its trend was consistent with the Recreational Headboat and Combined Video Survey indices. However, the poor model fit to this index in the SEDAR 68 AP Base Model was of concern, particularly the sharp increase in expected CPUE from 1999 to 2000 which was not supported by other data streams (see **Section 4.9**). The removal of this index was covered in the jack-knife analysis documented in the SEDAR 68 AP Report (see **Section 4.8.5**).

Given all of the issues pertaining to the two CPUE indices discussed above, the RW Panel requested a sensitivity run which included only the Combined Video Survey and the RFOP Vertical Line Survey. The justification for this run was to see how the model responded to the conflict in these two data streams.

Results: Removal of both the Recreational Headboat and pre-IFQ Commercial Vertical Line indices led to slightly lower estimates of virgin SSB and σ_R than the SEDAR 68 AP Base Model, whereas estimated steepness was slightly higher and estimated recruitment was similar (**Table 1**). Divergence of annual SSB estimates were noted in most years, although expected SSB remained within the uncertainty bounds of the SEDAR 68 AP Base Model for most years (**Figure 1**). This model run also exhibited higher F throughout the 1990s (with some years falling outside the uncertainty bounds) and since 2010 (**Figure 1**). Review of SS3 diagnostics (described in **Section 5.3.2**) did not reveal any major improvements.

3.1.4 von Bertalanffy asymptotic length, maximum length, and length bins

The RW Panel noted a large difference between the von Bertalanffy asymptotic length estimate (L_{∞}) of 70 cm Fork Length (FL) recommended by the SEDAR 68 DW and the maximum length (L_{\max}) of 129 cm FL observed in the length data and used to define the largest length bin of the population. They suggested a general rule of thumb that L_{∞} should never be less than 80% of L_{\max} (SEDAR 68 AP Base Model L_{∞} is 54% of L_{\max}). The RW Panel requested sensitivity runs reducing the maximum length bin from 129 cm FL, with the justification that data points falling outside this rule and away from the growth curve could affect reference points.

Results: The analytical team presented sensitivity runs for two plus group length bins which would fall within the rule of thumb: 75 cm FL ($L_{\infty} \sim 93\%L_{\max}$) and 84 cm FL ($L_{\infty} \sim 83\%L_{\max}$). No Scamp larger than 84 cm FL were observed in either the Combined Video Survey or the RFOP Vertical Line Survey, whereas <0.5% of Scamp landed were larger than 84 cm FL (0.2% Commercial Vertical Line, 0.07% Commercial Longline, 0.5% Recreational Charter Private, and 0.5% Recreational Headboat). Roughly 1-3% of Scamp were larger than 75 cm FL for each fleet (1.9% Commercial Vertical Line, 1% Commercial Longline, 2.1% Recreational Charter Private, and 2.8% Recreational Headboat). Modifying the plus group length bin did not have an effect on model outputs (**Figure 1**) or key parameter estimates (**Table 1**, compared to Model 2) but led to better fits for the length data (**Figure 6**) and reduced residuals for length compositions of Scamp retained by the Recreational Charter Private fleet (maximum residual reduced from 7.2 to 4.8) and Scamp sampled by the RFOP Vertical Line Survey (maximum residual reduced from 5.3 to 4.1; **Figure 7**). The smaller plus group of 75 cm FL led to higher proportions of retained lengths in the plus group (**Figure 8**) and similar improvements to residuals as noted above (**Figure 9**). Although these runs showed lower CVs on some of the selectivity parameters, uncertain parameters remained uncertain (i.e., CVs remained above 1).

3.1.5 Dirichlet multinomial parameters

The RW Panel supported the use of the Dirichlet-Multinomial (DM) approach for weighting length and age data in the SEDAR 68 AP Base Model. However, they noted that an upper bound of 5 was more appropriate because parameter estimates above 5 are associated with 99-100% weight with little information in the likelihood about the parameter value (Methot et al. 2020). Estimates at the upper bound of 5 can be fixed in the final model run since this estimate essentially means that weighting is not needed and that the input sample sizes are reasonable.

Results: Sensitivity runs first setting the upper bounds to 5 and then fixing parameters bounding in the final model run did not have a large effect on derived quantities (**Figure 1**) or key parameter estimates (**Table 1**).

4. Alternative model structure (SEDAR 68 RW Base Model)

The RW Panel recommended that the following changes be incorporated into a SEDAR 68 RW Base Model. Below we discuss each requested modification and justifications behind each recommendation. Changes in key parameter estimates and derived quantities for each modification are shown in **Table 2**. Comparison plots of derived quantities are shown for the RW Base Model In Progress (Model 11; **Figure 10**) and the SEDAR 68 RW Base Model (**Figure 11**).

4.1. Input landings in numbers and fit to mean body weight for each recreational fleet

The RW Panel supported inputting recreational landings in numbers and fitting to the mean body weight of Scamp landed for each recreational fleet in the SEDAR 68 RW Base Model for reasons discussed in **Section 3.1**. While Scamp are managed in weight in the Gulf of Mexico, the recreational surveys first and foremost sample numbers of fish and currently provide uncertainty estimates around those numbers. Fitting to mean body weight of landed Scamp will ensure that assessment model predictions are on par with mean body weight of Scamp observed in recreational surveys.

4.2. Include all indices of abundance and estimate an extra SD parameter for each

Ultimately, the RW Panel recommended retaining all indices of abundance and allowing the SS model to estimate an extra SD parameter for each index, which reflects added variance to the input standard deviation of the survey variability (Methot et al. 2020). A large estimated extra SD for an index would allow the assessment model to not fit that index well, and instead allow it to fit to more informative indices or other data sources (e.g., length compositions). In the SEDAR 68 RW Base Model, the estimated SD for the RFOP Vertical Line Survey was the highest of the indices (see **Section 5.2**), suggesting that this index is not contributing useful information to the model fit, as discussed by the RW Panel in **Section 3.1.2**.

This approach was preferred by the RW Panel over excluding indices recommended for use by the SEDAR 68 DW (e.g., RFOP Vertical Line Survey). Reasons for retaining the RFOP Vertical Line Survey data include the information content of the observer data (e.g., larger spatial coverage) and the thorough statistical approach taken to develop the index (SEDAR68-AW-04). While the RW Panel initially suggested estimating time-varying catchability for the RFOP Vertical Line Survey index to get a better fit, this approach was not pursued by the analytical team because of concerns that this modification would just absorb the noise.

4.3. Input and fit to nominal commercial age compositions

The RW Panel supported replacing the CAAL with nominal age compositions for the commercial fleets in the SEDAR 68 RW Base Model for the reasons discussed above in **Section 3.1.1**.

4.4. Increase the standard error (SE) for the starting F value for the Recreational Headboat fleet from 0.01 to 0.05

The RW Panel supported increasing the SE for the starting F value from 0.01 to 0.05 for consistency with the other fleets in the SEDAR 68 RW Base Model. While the Recreational Headboat landings were all given a log-scale SE of 0.3, the SE of 0.01 from the starting F for this fleet was carried into the landings for 1986 (evident in **Table 19** in the SEDAR 68 AP Report). The RW Panel agreed that the SE of 0.01 was likely too tight and should be increased to 0.05, a value consistently used for starting F values for all fleets in other Southeast stock assessments.

4.5. Bin all length data for Scamp 84 cm FL or larger

The RW Panel supported the specification of a plus group length bin of 84 cm FL in the SEDAR 68 RW Base Model for reasons discussed above in **Section 3.1.4**.

4.6. Set the upper bound of each Dirichlet parameter at 5

The RW Panel recommended that the upper bound of each Dirichlet parameter be set at 5 in the SEDAR 68 RW Base Model for reasons discussed in **Section 3.1.5**.

4.7. Fix steepness at biologically plausible value

Steepness received a substantial amount of discussion during both the AP and the RW. While the ADT ultimately recommended estimating steepness in the SEDAR 68 AP Base Model using a prior, the RW Panel concluded that steepness was not estimable for Gulf of Mexico Scamp. Gulf of Mexico Scamp data exhibited limited contrast, particularly in estimated SSB trends which did not drop below 1,500 metric tons (3.3 million pounds gutted weight). The prior value proposed by the ADT was uninformative and when steepness was estimated without a prior, the assessment model estimated a value of 0.99 at the upper bound. The inability of the SEDAR 68 AP Base Model to estimate steepness does not support estimation of MSY-based reference points for Gulf of Mexico Scamp. The RW Panel first discussed the computational convenience of fixing steepness at 0.99 and using average recent recruitment for MSY-proxy projections (e.g., Spawning-Potential Ratio), but did not recommend this approach. The RW Panel briefly discussed moving away from the Beverton-Holt spawner-recruit relationship in SS to Option 4, which does not require specification of steepness and allows recruitment deviations to be unconstrained. However, the RW Panel noted that Option 4 should only be used if recruitment is truly random. Given that steepness was estimable for South Atlantic Scamp, the RW Panel supported maintaining a Beverton-Holt spawner-recruit relationship. The RW Panel also recommended fixing steepness at a biologically plausible estimate. The value of 0.84 obtained from Shertzer and Conn (2012) was not recommended because this value was based on a meta-analysis of a wide array of species. Instead, the RW Panel recommended developing an average value (weighted by CV) based on the estimate for Scamp of 0.78 (CV = 0.27) from FishLife (Thorson et al. 2017) and the estimated value for South Atlantic Scamp (0.57, CV = 0.19; SEDAR 2021a). This approach resulted in a steepness estimate of 0.6935. It should be noted that relying on the estimate of steepness from the South Atlantic results in uncertainty about the final steepness used in the Operational Assessment and assumes that the conditions that affect their recruitment are similar in both regions.

4.8. Adjust natural mortality vector

The RW Panel was concerned about the relatively low M for age-0 Scamp of 0.49 per year (**Table 3** in the SEDAR 68 AP Report). The analytical team noted that for this assessment, and as in past Gulf of Mexico grouper assessments, this vector was adjusted to account for peak spawning (discussed in **Section 2.2.3** of the SEDAR 68 AP Report). For example, an age-0 Scamp would experience 7.5 months of age-0 mortality as opposed to a full year of age-0 mortality. The RW Panel recommended that the M-at-age vector be adjusted to not account for the shift in peak spawning and incorporated into the SEDAR 68 RW Base Model (**Table RW3; Figure RW2C**).

4.9. Estimate inflection points for each fishery retention curve

Time-varying retention, as parameterized in the SEDAR 68 AP Base Model, was considered a high priority area for exploration by the RW Panel because of patterns in residuals for composition data, fits to the discards, relatively large discards between 1990 and 1999, and the poor fit to the pre-IFQ Commercial Vertical Line index. Of particular concern was the fixing of the inflection point for the 1990-1999 retention curve for each fleet at the Florida state size limit. As mentioned toward the end of the SEDAR 68 AP Base Model Assessment presentation, this parameterization led to peak discards during this time period, which seemed unrealistic when compared with more recent years and fishery insights. While fishermen had to adhere to the Florida size limit for Scamp caught in state waters during this period, Scamp could be retained at any size if caught in federal waters where there was no size limit. The RW Panel requested that the analytical team revisit parameterization of retention, with a particular focus on the inflection points for each fishery retention curve.

Results: The analytical team conducted three sensitivity runs based on different parameterizations of time-varying retention:

1. *Exclusion of blocks.* This run estimated a single retention curve for each fleet over the entire time series and demonstrated the need for time-varying retention. This run led to fewer estimated parameters but a larger gradient (**Table 3**). The total NLL increased by 138 units in the absence of time-varying retention, and was largely driven by increased NLL for both the length and age compositions (**Table 4**). Compared to the RW Base In Progress Model (Model 11), this modification led to slightly higher SSB in more recent years, similar estimates of recruitment, and considerably lower F from 1986 through 1998 (**Figure 12**).

2. *Estimate inflection points of retention curves.* This run evaluated the effect of freely estimating the inflection points instead of fixing them as in the SEDAR 68 AP Base Model. While this run included 10 additional parameters, fewer parameters exhibited CVs above 1 (**Table 3**). Other differences included a considerably lower NLL (**Table 4**), higher recruitment variability (σ_R) but similar estimates for key quantities (**Table 3**). The decrease in total NLL was largely driven by the fits to the length compositions for all data sources except the Commercial Longline fleet, fits to indices of abundance, and the discards (**Table 4**). Compared to the RW Base In Progress Model (Model 11), this configuration led to slightly higher SSB estimates in most years, similar recruitment estimates, and lower F from 1990 until 1999 (**Figure 12**). In the SEDAR 68 AP Base Model, the fixed inflection point for 1990 through 1998 caused the concerning change in scale of the pre-IFQ Commercial Vertical Line index from lower CPUE until 1998 to higher CPUE from 1999 onward (**Figure 13**).

3. *Reduce retention blocks and base solely on federal size limit.* This run evaluated the feasibility of using fewer retention blocks (and therefore fewer parameters) for time-varying retention based solely on federal regulations. This model run increased the total NLL by 78 units, and was primarily driven by worse fits to the length and age compositions (**Table 4**). Compared to the RW Base In Progress Model (Model 11), this configuration led to considerably larger SSB estimates in many years, larger estimated recruitment throughout the 2000s, and consistently lower F from 1990 until 1999 and in the last few years (**Figure 12**).

The RW Panel supported the use of time-varying retention and the estimation of the inflection points for each retention curve for each fleet in the SEDAR 68 RW Base Model.

4.10. Fix Dirichlet parameter(s) being estimated at the upper bound

The RW Panel recommended fixing any estimated Dirichlet parameters bounding at 5 in the final model run for the SEDAR 68 RW Base Model, as discussed in **Section 3.1.5**.

5. Alternative model structure and comparison to the SEDAR 68 AP Base Model

Tables and Figures are provided in the Appendix for SEDAR 68 RW Base Model, with parameter estimates in **Table RW10** and data streams used in **Figure RW1**. The SEDAR 68 RW Base Model input and fit to recreational landings in numbers (**Table 6B** in SEDAR 68 AP Report; **Figure RW4**), mean body weight of Scamp landed by each recreational fleet (SEDAR68-RW-01), and nominal age compositions for both commercial fleets. Annual nominal age compositions corresponding to 10 or more trips were included for the Commercial Vertical Line fleet (**Figure RW5A**) and the Commercial Longline fleet (**Figure RW5B**).

5.1. Derived quantities

Annual fishing mortality estimates differed considerably during the first half of the time series between models, with the SEDAR 68 RW Base Model estimating consistently lower F from 1986 until 1998 (**Table RW11; Figures 14, RW11**). This was largely due to the change in modeling retention as discussed in **Section 4.9**, and led to reduced fleet-specific exploitation rates in many years (**Figures 15, RW12**). Higher F estimates in more recent years for the SEDAR 68 RW Base Model were primarily due to changes in input data for the recreational fleets (**Figure 1**).

Estimated length-based selectivity patterns were similar for most fleets, with the exception of a noticeably smaller asymptote for the Recreational Charter Private fleet (**Figures 16, RW13**). The parameter defining the selectivity for the largest Scamp for this fleet no longer exhibited a CV above 1 (**Table RW10**). While the parameter defining the width of the plateau for the Recreational Headboat fleet also no longer had a CV above 1, the descending limb was still uncertain in the SEDAR 68 RW Base Model. The derived age-based selectivity patterns also differed slightly for the Recreational Charter Private fleet (**Figures 17, RW14**). Estimating the inflection points of each retention curve led to a distinct change in the retention pattern for 1990 to 1998 for both commercial fleets (**Figures 18-19, RW15**) and both recreational fleets (**Figures 20-21, RW16**). In addition, the 2003 to 2017 time block also changed for both recreational fleets (**Figures 20-21, RW16**).

Similar to the SEDAR 68 AP Base Model result, the spawner-recruit relationship for the SEDAR 68 RW Base Model revealed a weak relationship between spawners and recruits, largely due to limited contrast and no low SSB estimates (**Figures 22, RW17**). Estimated recruitment and recruitment deviations varied between models (**Figures 23-24, RW18-19**), with peak values displaced by a year in some cases due to changes to the commercial age data (**Figure 1**). The SEDAR 68 RW Base Model estimated a higher sigmaR of 0.44 and greater overall variability (**Figures 25, RW20**). Trends in SSB were similar between models during much of the time

series, with the exception of the early and later years (**Table RW12; Figures 26, RW21-22**). The SEDAR 68 RW Base Model estimated a slightly higher SSB₀ (with larger uncertainty bounds) and substantially higher SSB in the 1980s and early 1990s (**Figure 26**). While SSB estimates were reduced in the most recent years, these estimates remained within the uncertainty bounds of the SEDAR 68 AP Base Model (**Figure 26**). Sex-specific estimates and sex ratios are provided in **Table RW13**. Annual numbers-at-age (1,000s of fish) and biomass-at-age (metric tons) are provided for female and male Scamp in **Table RW14** and **Table RW15**, respectively, and **Figures RW23-24**.

5.2. Model fits

The SEDAR 68 RW Base Model fits to landings were similar to the SEDAR 68 AP Base Model, with larger differences in observed and expected landings evident for the Recreational Charter Private fleet (**Figures 27, RW25**), stemming from greater uncertainty (log-scale SE of 0.3). NLL by data component are provided in **Table 5** for both model but are not directly comparable due to changes in input data. Both commercial fleets exhibited expected discards closer to the observed discards in 2003 through 2005, and predicted discards from 1990 through 1998 were more in line with recent estimates (**Figures 28-31, RW26**). The SEDAR 68 RW Base Model fits to the discards for the Recreational Charter Private fleet showed more similar values in the late 1990s (**Figure 32**) and less pronounced predicted discards between 1990 and 1998 (**Figures 33, RW27**). Fits to the discards for the Recreational Headboat fleet were similar between models (**Figure 34**), and predicted discards from 1990 through 1998 were reduced from 2000 levels (**Figures 35, RW27**). Expected and observed landings and discards are provided in **Tables RW16-19** and **Tables RW20-23**, respectively.

Notable improvements were evident in the SEDAR 68 RW Base Model fits to the indices of abundance for the pre-IFQ Commercial Vertical Line index (**Figures 36, RW28A**) and the Recreational Headboat index (**Figures 37, RW28B**), with similar fits for the Combined Video Survey (**Figures 38, RW28C**) and the RFOP Vertical Line Survey (**Figures 39, RW28D**). All of the data sources revealed similar or improved fits to length compositions (**Figures 40, RW33**) and similar or reduced residuals (**Figures 41, RW29-32**). Expected and observed indices are provided in **Table RW24** for fishery-dependent CPUE and **Table RW25** for the fishery-independent Combined Video Survey and the RFOP Vertical Line Survey. Extra SD estimated by SS, ordered from highest to lowest, was 0.305 for the RFOP Vertical Line Survey, 0.132 for the Combined Video Survey, 0.06 for the pre-IFQ Commercial Vertical Line index, and 0.039 for the Recreational Headboat index (**Table RW10**).

Annual fits to nominal age compositions for the Commercial Vertical Line fleet showed considerable variability and often poor agreement between observed and expected compositions (**Figure RW34A**). Input sample sizes averaged 100 trips and ranged from 10 to 238. While a few years showed good agreement of peak composition (e.g., 1995-1996), the model tended to expect younger Scamp in many years. The Pearson residuals showed a severe underestimation of older Scamp in the last ten years (min = -4.46, max = 3.69; **Figure RW34A**). Differences in observed and expected mean age were evident, as the expected mean age rarely remained within the 95% confidence intervals of observed mean age (**Figure RW34B**).

Annual fits to nominal age compositions for the Commercial Longline fleet showed similarly unsatisfactory fits as discussed above for the Commercial Vertical Line fleet (**Figure RW35A**).

Input sample sizes were similarly variable (mean = 100 trips, range: 19-228). Almost all years showed poor agreement of peak composition, as the model tended to expect younger Scamp (**Figure RW35A**). The Pearson residuals showed a severe underestimation of older Scamp throughout much of the time series (min = -2.82, max = 3.38). Similar discrepancies in observed and expected mean age were evident, as the expected mean age rarely remained within the 95% confidence intervals of the observed mean age (**Figure RW35B**).

Aggregated across years, the SEDAR 68 RW Base Model expected older Scamp compared to those observed for both recreational fleets, but younger Scamp for both commercial fleets, resulting in poor overall fits to the age compositions (**Figures 42, RW38**). Clearly, for all fleets there was a trade-off in fitting either the length compositions (weighted for commercial and nominal for recreational) or the nominal age compositions. However, the residuals for the recreational fleets were reduced in magnitude for the SEDAR 68 RW Base Model compared to the SEDAR 68 AP Base Model (**Figures 43, RW36-37**).

5.3. Diagnostics

5.3.1. Diagnostics from Assessment Process

Likelihood profiles for the SEDAR 68 RW Base Model showed similar results to the SEDAR 68 AP Base Model, with conflicts noted for some data inputs but the SEDAR 68 RW Base Model estimates corresponding to the lowest total NLL for key parameters (**Figure RW39**). As observed for the SEDAR 68 AP Base Model, the length data supported a higher value of the von Bertalanffy K parameter (0.12) compared to the age data (0.085). The jitter analysis did not identify any viable runs with a NLL lower than the SEDAR 68 RW Base Model (**Figure RW40A**). While many of the jitter runs resulted in fairly similar trends in key parameters (**Figure RW40B**) and derived quantities (**Figure RW40C**), the RW Panel was concerned about the variability within the jitter. Only 20 jitter runs had the same NLL as the SEDAR 68 RW Base Model, whereas only 50 jitter runs were within 50 NLL units. Those jitter runs which exhibited the highest gradients often had retention parameters with similarly high gradients. The SEDAR 68 RW Base Model exhibited more moderately correlated parameters (**Table RW26**) compared to SEDAR 68 AP Base Model, which likely contributed to the variability identified in the jitter analysis. The retrospective analysis revealed similar trends to the SEDAR 68 RW Base Model (**Figure RW41**), and remains an issue for further investigation during the Operational Assessment. The jack-knife analysis which removed one index of abundance at a time revealed the importance of the Recreational Headboat index, where its removal led to larger shifts in SSB and F in the earliest years (**Figure RW42**), higher virgin SSB, and more parameters with CVs exceeding 1 (**Table RW27**).

5.3.2. SS3 diagnostics following Carvahlo et al. (2021)

Additional diagnostics are presented following the recommendations of Carvahlo et al. (2021) using the R package ‘SS3Diags’. Joint residual plots were used to assess goodness of model fit by identifying conflicting time series and auto-correlation of residual patterns via a Loess smoother (Winker et al. 2018; Carvahlo et al. 2021). The SEDAR 68 AP Base Model displayed an undesirably high RMSE (> 30%) for the joint residuals from indices of abundance but acceptable levels (< 30%) for both age and length compositions (**Table 6**). In contrast, the SEDAR 68 RW Base Model resulted in a lower RMSE of 30% for the joint residuals for the

indices of abundance, lower RMSE for the joint residuals for age compositions, and similar RMSE for the joint residuals for the length compositions (**Table 6**). Residuals for both models revealed some conflict in indices of abundance (evident by colored vertical lines in opposite directions) and trends in the residuals (evident by Loess smoothed line; **Figure 44A**). Similar conflicts were noted in the SEDAR 68 RW Base Model for age compositions, although there was more randomness in the residuals compared to the SEDAR 68 AP Base Model where almost all residuals were negative (**Figure 44B**). The lowest RMSE was exhibited in both models for the length composition, which exhibited the smallest residuals but did reveal some conflicts (**Table 6**; **Figure 44C**).

Model misspecification was identified by exploring patterns in residuals using a runs test, which indicates the presence of nonrandom variation (Carvahlo et al. 2021). In addition, outlier data points were identified via the 3-sigma limit, where any points beyond 3 SD would be unlikely given random process error in the observed residual distribution (Carvahlo et al. 2021). Runs test results revealed evidence of non-randomly distributed residuals in both models (**Table 7**). In the SEDAR 68 RW Base Model, this undesirable result occurred for the pre-IFQ Commercial Vertical Line index of abundance, commercial age compositions, Recreational Charter Private age compositions, Recreational Headboat length compositions, and Combined Video Survey length compositions (**Table 7**; **Figure 45**). Similar results were obtained for the SEDAR 68 AP Base Model concerning the indices and Recreational Charter Private age composition, although the Commercial Vertical Line length composition also revealed non-randomly distributed residuals. For the SEDAR 68 RW Base Model, fewer outliers (evident by red points) were identified in residuals for indices (**Figure 45A**), in residuals for age compositions for both recreational fleets (**Figure 45B**), and in residuals for length compositions for the Combined Video Survey (**Figure 45C**).

Retrospective analysis was used to check the consistency of model estimates of key derived quantities as sequential years of data were peeled off (Carvahlo et al. 2021). Mohn's Rho can be used to determine retrospective bias, with values between -0.15 to 0.2 considered acceptable for longer-lived species and values outside that range indicate of an undesirable retrospective pattern (Hurtado-Ferro et al. 2015; Carvahlo et al. 2021). A positive Mohn's Rho would be indicative of a systemic overestimation of the derived quantity. Retrospective forecasts were also evaluated to determine consistency between forward projections and subsequent updates with newly available data added one year at a time (Carvahlo et al. 2021). Unfortunately, the SEDAR 68 RW Base Model exhibited strong retrospective bias and poor forecasting bias in both SSB (Mohn's Rho of -0.22; Forecasting Bias of -0.24) and F (Mohn's Rho of 0.37; Forecasting Bias of 0.42; **Table 8**; **Figure 46**). While the first few years remained within the 95% confidence intervals of the SEDAR 68 RW Base Model, trends diverged considerably for 2014 and earlier years (**Table 8**), as these years displayed a considerable shift in scale (**Figure 46**).

Prediction skill of each model was tested using the hindcasting cross-validation approach of Kell et al. (2021). The mean absolute scaled error (MASE; Hyndman and Koehler 2006) was calculated for a 5-year period for each data input where available. The MASE scales the mean absolute error (MAE) of forecasts (i.e., prediction residuals) to the MAE of a naïve in-sample prediction (Carvahlo et al. 2021). A skilled model would improve the model forecast compared to the baseline (i.e., random walk), with a MASE value of 0.5 indicative of a forecast being twice as accurate as the baseline and values >1 indicative of average model forecasts worse than the baseline (Carvahlo et al. 2021; Kell et al. 2021). Superior prediction skill (<1) was evident for

the SEDAR 68 RW Base Model over the naive baseline forecast for the Recreational Headboat index (**Figure 47A**), mean age for both the Commercial Longline and Recreational Headboat fleets (**Figure 47B**), and mean length for all fleets/surveys except the Combined Video Survey (**Figure 47C**; **Table 9**). The RFOP Vertical Line Survey revealed the worst hindcasting ability (**Figure 47A**). Similar results were obtained for the SEDAR 68 AP Base Model.

5.3.3. Sensitivity runs

Sensitivity runs were conducted with the SEDAR 68 RW Base Model to investigate critical uncertainty in data and reactivity to modeling assumptions. An exhaustive evaluation of model uncertainty was not carried out during the RW, but the aspects of model uncertainty judged to be the most important for model performance and accuracy were investigated. Focus of the sensitivity runs was on population trajectories and important parameter estimates (e.g., recruitment).

Growth Estimation - In the SEDAR 68 RW Base Model, the only growth parameter estimated was the length at the minimum age, L_{Amin} . The SEDAR 68 RW Panel requested sensitivity runs attempting the estimation of other growth parameters because of concerns that the fixed growth parameters were causing the tension in fitting length and age data simultaneously. The analytical team conducted five sensitivity runs:

1. *Estimate K & L_{∞} using a symmetric beta prior ($SD = 0.8$)* - use prior values recommended by the SEDAR 68 DW Life History Working Group (LHWG).
2. *Estimate L_{∞} using a symmetric beta prior ($SD = 0.8$)* - use prior value recommended by the SEDAR 68 DW LHWG.
3. *Estimate K using a symmetric beta prior ($SD = 0.8$)* - use prior value recommended by the SEDAR 68 DW LHWG.
4. *Estimate the CV for A_{max}* - estimate using starting value recommended by the SEDAR 68 DW LHWG, which will allow fish to be bigger.
5. *Fix the CV for A_{max} at 0.2* - fix at 0.2, which will trick the model into allowing Scamp to be bigger.

Results: Estimating additional growth parameters led to a few additional parameters with CVs exceeding 1 in each scenario (**Table RW27**). This modification had a very large impact on SSB and F and a moderate effect on estimated recruitments (**Figure RW46**) and key parameter estimates (**Table RW27**). Estimating L_{∞} and K led to a considerably larger L_{Amin} , a larger L_{∞} , and a much slower K . As observed for the SEDAR 68 AP Base Model, these estimates of L_{∞} and K did not fall within the uncertainty range of parameter estimates provided by the SEDAR 68 DW LHWG (**Table 9** in DW Report), and therefore this configuration was not pursued for the Base Model. When estimating both K and L_{∞} , SS3 diagnostics revealed degraded fits for the length compositions but better fits to the mean age compositions, and revealed undesirable retrospective bias. Estimating L_{∞} alone led to a larger L_{Amin} and a slightly smaller L_{∞} , whereas estimating K led to a larger L_{Amin} and a slower K . Estimating CV_{Amax} led to less estimated variability of length-at-age for older Scamp, which went against the recommendation made by the SEDAR 68 DW LHWG.

6. Further investigations warranted

6.1 Estimation of growth

While sensitivity runs were attempted for estimating growth parameters for both the SEDAR 68 AP Base Model and the SEDAR 68 RW Base Model, additional investigations are warranted to rectify the trade-offs between fitting age and length compositions. Age and growth data for the Operational Assessment should be re-evaluated after additional age estimates become available for 2003 through 2012 and the maximum length should be revisited in relation to the estimated von Bertalanffy asymptotic length.

6.2 Selectivity and retention

The jitter analysis revealed lots of variability which concerned some of the RW Panel. The RW Panel suggested using model selection criteria (e.g., AIC) to determine whether estimation of all of the additional parameters in the SEDAR 68 RW Base Model are warranted. Further evaluation of retention and selectivity parameters via likelihood profiles could help identify parameters that could be fixed or given priors to help stabilize the model and help reduce the number of moderately and highly (Recreational Headboat selectivity) correlated parameters (**Table RW26**).

6.3 Retrospective bias

Given the retrospective bias and poor forecasting bias of the SEDAR 68 RW Base Model, additional efforts are warranted to reduce these trends. However, the RW Panel emphasized that these results should be considered in conjunction with all other diagnostics and that Mohn's Rho was originally designed to look at bias from Virtual Population Analysis. With integrated analyses, Mohn's Rho is not comparing displacement from a converged value, but rather comparing results after refitting the model to the reduced data.

7. Other issues discussed but not pursued further during the RW

Start Year: The RW Panel discussed moving away from a 1986 start year. An earlier start year was suggested, but ultimately this was not ranked a high priority by the RW Panel because it would have required additional analytical resources to hindcast recreational landings in weight back in time (which would require assumptions regarding the mean weight of landed Scamp over time). The RW Panel also discussed a later start year of 1996, which was based on increased data availability. However, it was noted that truncating the model too much could have unintended consequences on population trajectories.

Retrospective runs: The RW Panel briefly discussed whether the choice of the start year could influence the population trajectories. Along the same lines of a retrospective analysis, the RW Panel suggested conducting a similar analysis for the start year by starting the model one year later in sequence (i.e., start in 1986, 1987, 1988, 1989, and 1990). The motivation for this request was to determine whether the scale of the biomass changes as additional years of data at the start of the model are excluded. Ultimately, this request was deemed low priority and not recommended for evaluation during the RW.

Discard component of the catch: The RW Panel debated the need for the added complexity by modeling retention given the small magnitude of dead discards for three of the four fleets. Discard estimates of total discards (i.e., before applying discard mortality) were highly uncertain and variable, particularly for the Recreational Charter Private fleet. This fleet exhibited very high total discards, although dead discards were still small compared to landings (**Figure 33**). While the RW Panel suggested adding in the weight of discards into the total catch, this approach was not pursued for two reasons: (1) discard estimates are not available in weight for the recreational fisheries and (2) dead discards do not factor into the specification of the Overfishing Limit.

Data Weighting: The RW Panel asked whether other approaches for data weighting were pursued during SEDAR 68 other than using the Dirichlet-Multinomial. The RW Panel discussed the Sablefish assessment where the choice of data weighting was important in determining the stock trajectory and where the Francis weighting approach was preferred for that assessment. Francis weighting tends to give more weight to surveys and indices and less weight to growth parameters and composition data.

Time-varying Selectivity: The RW Panel discussed the residual patterns in the composition fits and raised concerns over some of the selectivity patterns. As noted in the SEDAR 68 AP Report, the recreational fleets did display highly uncertain selectivity parameters. The RW Panel suggested allowing selectivity to vary over time via a random walk, but ultimately did not request any additional sensitivity runs during the RW.

8. References

Carvalho F, H Winker, D Courtney, M Kapur, L Kell, M Cardinale, M Schirripa, T Kitakado, D Yemane, KR Piner and MN Maunder. 2021. A cookbook for using model diagnostics in integrated stock assessments. *Fisheries Research* 240: 105959.

<https://doi.org/10.1016/j.fishres.2021.105959>

Hurtado-Ferro F, CS Szuwalski, JL Valero, SC Anderson, CJ Cunningham, KF Johnson, R Licandeo, CR McGilliard, CC Monnahan, ML Muradian and K Ono. 2015. Looking in the rear-view mirror: bias and retrospective patterns in integrated, age-structured stock assessment models. *ICES Journal of Marine Science* 72(1):99-110. <https://doi.org/10.1093/icesjms/fsu198>

Methot RD, CR Wetzel, IG Taylor and K Doering. 2020. Stock Synthesis User Manual Version 3.30.16. NOAA Fisheries, Seattle Washington. 225 pp.

SEDAR (Southeast Data Assessment and Review). 2021a. SEDAR68: Atlantic Scamp Grouper Stock Assessment Report. SEDAR, North Charleston, SC. 105 p. Available at:

<http://sedarweb.org/sedar-68>.

SEDAR (Southeast Data Assessment and Review). 2021b. SEDAR72: Gulf of Mexico Gag Grouper Stock Assessment Report. SEDAR, North Charleston, SC. 318 p. Available at:

<http://sedarweb.org/sedar-72>.

Shertzer KW and PB Conn. 2012. Spawner-recruit relationships of demersal marine fishes: prior distribution of steepness. *Bulletin of Marine Science*, 88(1):39-50.

Thorson JT, SB Munch, JM Cope and J Gao. 2017. Predicting life history parameters for all fishes worldwide. *Ecological Applications* 27(8):2262-2276. <https://doi.org/10.1002/eap.1606>

Winker H, F Carvalho, and M Kapur. 2018. JABBA: Just Another Bayesian Biomass Assessment. *Fisheries Research* 204:275–288. <https://doi.org/10.1016/j.fishres.2018.03.010>.

Winker H, F Carvalho, JT Thorson, LT Kell, D Parker, M Kapur, R Sharma, AJ Booth and SE Kerwath. 2020. JABBA-Select: Incorporating life history and fisheries' selectivity into surplus production models. *Fisheries Research* 222:105355. <https://doi.org/10.1016/j.fishres.2019.105355>

9. Tables

Table 1. Summary of initial sensitivity runs conducted for Gulf of Mexico Scamp during the SEDAR 68 RW. NLL = negative log-likelihood, CV = coefficient of variation, L_{∞} = von Bertalanffy asymptotic length, L_{\max} = maximum length. Note that NLL are not directly comparable due to changes in input data.

| Description | NLL | Gradient | Estimated Parameters (Bounded) | Parameters with CV>1 |
|---|-----------|----------|--------------------------------|----------------------|
| 1. SEDAR 68 AP Base | 16,650.50 | 0.002 | 220 (1) | 14 |
| Homework 1 | | | | |
| 2. 1 + Fit to numbers and mean body weight for recreational fleets | 16,645.70 | 0.003 | 220 (0) | 15 |
| 2 + Use nominal age compositions | 8,877.86 | 0.006 | 220 (1) | 18 |
| 2 + Remove Reef Fish Observer Program (RFOP) Survey (no hessian) | 15,151.70 | 0.025 | | |
| 2 + Remove RFOP survey and set Headboat start F standard error = 0.05 | 15,151.70 | 0.001 | 220 (0) | 17 |
| 2 + Remove Headboat and pre-IFQ Commercial Vertical Line indices | 16,672.60 | 0.077 | 220 (0) | 14 |
| 2 + Set length plus group bin to 84 cm Fork Length ($L_{\infty} \sim 83\%$ of L_{\max}) | 15,649.00 | 0.036 | 220 (0) | 13 |
| 2 + Set length plus group bin to 75 cm Fork Length ($L_{\infty} \sim 93\%$ of L_{\max}) | 15,282.50 | 0.001 | 220 (0) | 13 |
| 2 + Set upper bound for Dirichlet parameters at 5 | 16,653.90 | 0.041 | 220 (7) | 17 |
| 2 + Fix bounded Dirichlet parameters at the upper bound | 16,648.30 | 0.002 | 214 (0) | 15 |

Table 1 Continued. Summary of initial sensitivity runs conducted for Gulf of Mexico Scamp during the SEDAR 68 RW. sigmaR = recruitment variability, Ln(R0) = virgin equilibrium recruitment estimated in log space.

| Description | Steepness | sigmaR | Ln(R0) | Virgin SSB (metric tons) | Virgin Recruitment (1,000s of fish) |
|---|-----------|--------|--------|-----------------------------|---|
| 1. SEDAR 68 AP Base | 0.949 | 0.356 | 7.433 | 3,911 | 1,691 |
| Homework 1 | | | | | |
| 2. 1 + Fit to numbers and mean body weight for recreational fleets | 0.961 | 0.358 | 7.357 | 3,620 | 1,566 |
| 2 + Use nominal age compositions | 0.952 | 0.368 | 7.318 | 3,704 | 1,507 |
| 2 + Remove Reef Fish Observer Program (RFOP) Survey (no hessian) | | | | | |
| 2 + Remove RFOP survey and set Headboat start F standard error = 0.05 | 0.957 | 0.374 | 7.353 | 3,608 | 1,561 |
| 2 + Remove Headboat and pre-IFQ Commercial Vertical Line indices | 0.964 | 0.348 | 7.393 | 3,753 | 1,625 |
| 2 + Set length plus group bin to 84 cm Fork Length ($L_{\infty} \sim 83\%$ of L_{\max}) | 0.960 | 0.359 | 7.360 | 3,636 | 1,573 |
| 2 + Set length plus group bin to 75 cm Fork Length ($L_{\infty} \sim 93\%$ of L_{\max}) | 0.960 | 0.359 | 7.360 | 3,634 | 1,572 |
| 2 + Set upper bound for Dirichlet parameters at 5 | 0.961 | 0.359 | 7.356 | 3,616 | 1,565 |
| 2 + Fix bounded Dirichlet parameters at the upper bound | 0.961 | 0.358 | 7.357 | 3,621 | 1,567 |

Table 2. Summary of runs building to the Gulf of Mexico Scamp SEDAR 68 RW Base Model (Model 15). NLL = negative log-likelihood, CV = coefficient of variation. Note that NLL are not directly comparable in many instances due to changes in input data.

| Description | NLL | Gradient | Estimated Parameters (Bounded) | Parameters with CV>1 |
|---|-----------|----------|--------------------------------|----------------------|
| 1. SEDAR 68 AP Base | 16,650.50 | 0.002 | 220 (1) | 14 |
| 2. 1 + Fit to numbers and mean body weight for recreational fleets | 16,645.70 | 0.003 | 220 (0) | 15 |
| RW Base In Progress | | | | |
| 3. 2 + Parameters for extra standard deviation | 16,645.00 | 0.146 | 224 (0) | 15 |
| 4. 3 + Use commercial age composition | 8,877.41 | 0.085 | 224 (1) | 18 |
| 5. 4 + Increase start F standard error for Headboat to 0.05 | 8,877.41 | 0.027 | 224 (1) | 18 |
| 6. 5 + Length plus group bin = 84 cm Fork Length | 7,902.16 | 0.012 | 224 (1) | 17 |
| 7. 6 + Set upper bound of Dirichlet parameters at 5 | 7,902.19 | 0.005 | 224 (3) | 17 |
| 8. 7 + Fix steepness at 0.99 | 7,899.63 | 0.019 | 223 (3) | 17 |
| 9. 8 + Natural mortality adjustment | 7,899.67 | 0.024 | 223 (3) | 17 |
| 10. 9 + Recruitment bias adjustment | 7,902.99 | 0.011 | 223 (3) | 17 |
| 11. 10 + Fix Dirichlet parameters bounding at 5 | 7,902.98 | 0.009 | 221 (1) | 17 |
| Additional Adjustments to RW Base Model | | | | |
| 12. 11 + Estimate retention inflection points | 7,817.66 | 0.012 | 231 (1) | 14 |
| 13. 12 + Fix steepness at 0.6935 (composite of FishLife & SA Scamp) | 7,825.95 | 0.014 | 231 (1) | 14 |
| 14. 13 + Recruitment bias adjustment | 7,826.97 | 0.037 | 231 (1) | 13 |
| 15. 14 + Fix Dirichlet parameters bounding at 5 | 7,826.97 | 0.026 | 230 (0) | 13 |

Table 2 Continued. Summary of runs building to the Gulf of Mexico Scamp SEDAR 68 RW Base Model (Model 15). σ_R = recruitment variability, $\ln(R_0)$ = virgin equilibrium recruitment estimated in log space.

| Description | Steepness | σ_R | $\ln(R_0)$ | Virgin SSB (metric tons) | Virgin Recruitment (1,000s of fish) |
|---|-----------|------------|------------|-----------------------------|---|
| 1. SEDAR 68 AP Base | 0.949 | 0.356 | 7.433 | 3,911 | 1,691 |
| 2. 1 + Fit to numbers and mean body weight for recreational fleets | 0.961 | 0.358 | 7.357 | 3,620 | 1,566 |
| RW Base In Progress | | | | | |
| 3. 2 + Parameters for extra standard deviation | 0.960 | 0.362 | 7.355 | 3,613 | 1,563 |
| 4. 3 + Use commercial age composition | 0.952 | 0.371 | 7.317 | 3,700 | 1,505 |
| 5. 4 + Increase start F standard error for Headboat to 0.05 | 0.952 | 0.371 | 7.317 | 3,700 | 1,505 |
| 6. 5 + Length plus group bin = 84 cm Fork Length | 0.951 | 0.360 | 7.339 | 3,750 | 1,539 |
| 7. 6 + Set upper bound of Dirichlet parameters at 5 | 0.951 | 0.360 | 7.339 | 3,750 | 1,539 |
| 8. 7 + Fix steepness at 0.99 | 0.990 | 0.359 | 7.338 | 3,743 | 1,537 |
| 9. 8 + Natural mortality adjustment | 0.990 | 0.360 | 7.435 | 3,745 | 1,694 |
| 10. 9 + Recruitment bias adjustment | 0.990 | 0.399 | 7.432 | 3,737 | 1,689 |
| 11. 10 + Fix Dirichlet parameters bounding at 5 | 0.990 | 0.399 | 7.432 | 3,737 | 1,689 |
| Additional Adjustments to RW Base Model | | | | | |
| 12. 11 + Estimate retention inflection points | 0.990 | 0.420 | 7.405 | 3,759 | 1,644 |
| 13. 12 + Fix steepness at 0.6935 (composite of FishLife & SA Scamp) | 0.694 | 0.421 | 7.418 | 3,820 | 1,666 |
| 14. 13 + Recruitment bias adjustment | 0.694 | 0.445 | 7.417 | 3,817 | 1,664 |
| 15. 14 + Fix Dirichlet parameters bounding at 5 | 0.694 | 0.445 | 7.417 | 3,817 | 1,664 |

Table 3. Summary of retention sensitivity runs for the Gulf of Mexico Scamp SEDAR 68 RW Base Model In Progress (Model 11). CV = coefficient of variation, sigmaR = recruitment variability, R0 = virgin equilibrium recruitment estimated in log space.

| Quantity | RW Base In Progress (Model 11) | Estimate Inflections | Remove Blocks | Reduced Blocks |
|-------------------------------------|-----------------------------------|-------------------------|------------------|-------------------|
| Gradient | 0.009 | 0.0118 | 0.0387 | 0.0026 |
| Estimated Parameters (Bounded) | 221 (1) | 231 (1) | 207 (0) | 215 (1) |
| Parameters with CVs > 1 | 17 | 14 | 13 | 17 |
| Steepness | 0.99 | 0.99 | 0.99 | 0.99 |
| sigmaR | 0.399 | 0.42 | 0.459 | 0.392 |
| Ln(R0) | 7.432 | 7.405 | 7.409 | 7.506 |
| Virgin SSB (metric tons) | 3,737 | 3,759 | 3,776 | 3,913 |
| Virgin Recruitment (1,000s of fish) | 1,689 | 1,644 | 1,651 | 1,818 |

Table 4. Summary of negative log-likelihoods (NLL) by data component (grey rows) and by fleets/surveys for retention sensitivity runs for the Gulf of Mexico Scamp SEDAR 68 RW Base Model In Progress (Model 11).

| NLL | RW Base In Progress (Model 11) | Estimate Inflection | Remove Blocks | Reduced Blocks |
|--|-----------------------------------|------------------------|------------------|-------------------|
| Total | 7,903 | 7,818 | 8,041 | 7,981 |
| Catch | 28 | 25 | 25 | 29 |
| Commercial Vertical Line | 0.3 | 0.1 | 0.1 | 0.2 |
| Commercial Longline | 0.1 | 0.1 | 0.1 | 0.1 |
| Recreational Charter Private | 21 | 19 | 21 | 21 |
| Recreational Headboat | 6 | 5 | 4 | 8 |
| Indices | -48 | -65 | -54 | -64 |
| pre-IFQ Commercial Vertical Recreational Headboat | -5 | -13 | -13 | -16 |
| Recreational Headboat | -25 | -30 | -21 | -25 |
| Combined Video | -14 | -17 | -16 | -18 |
| RFOP Vertical Line | -4 | -4 | -4 | -5 |
| Discards | 20 | 4 | 21 | 13 |
| Commercial Vertical Line | -12 | -14 | -11 | -14 |
| Commercial Longline | -8 | -10 | -4 | -8 |
| Recreational Charter Private | 40 | 30 | 41 | 32 |
| Recreational Headboat | -0.3 | -1.6 | -5 | 3.4 |
| Length composition | 5,803 | 5,736 | 5,926 | 5,888 |
| Commercial Vertical Line | 1,346 | 1,323 | 1,372 | 1,369 |
| Commercial Longline | 1,012 | 1,013 | 1,025 | 1,025 |
| Recreational Charter Private | 702 | 693 | 715 | 750 |
| Recreational Headboat | 1,099 | 1,070 | 1,176 | 1,105 |
| Combined Video | 576 | 572 | 575 | 572 |
| RFOP Vertical Line | 1,068 | 1,064 | 1,063 | 1,067 |
| Age composition | 2,080 | 2,096 | 2,101 | 2,096 |
| Commercial Vertical Line | 606 | 619 | 615 | 603 |
| Commercial Longline | 802 | 835 | 833 | 791 |
| Recreational Charter Private | 315 | 299 | 303 | 333 |
| Recreational Headboat | 357 | 343 | 350 | 369 |

Table 5. Summary of negative log-likelihoods (NLL) by data component (grey rows) and by fleet/surveys for both the Gulf of Mexico Scamp SEDAR 68 RW Base Model and SEDAR 68 AP Base Model. Note that NLL are not directly comparable due to changes in input data.

| NLL | SEDAR 68 AP Base | SEDAR 68 RW Base |
|----------------------------------|------------------|------------------|
| Total | 16,651 | 7,827 |
| Catch | 32 | 25 |
| Commercial Vertical Line | 0.3 | 0.1 |
| Commercial Longline | 0.1 | 0.1 |
| Recreational Charter Private | 24 | 19 |
| Recreational Headboat | 8 | 5 |
| Indices | -47 | -63 |
| pre-IFQ Commercial Vertical Line | -4 | -14 |
| Recreational Headboat | -24 | -30 |
| Combined Video | -15 | -15 |
| RFOP Vertical Line | -4 | -4 |
| Discards | 35 | 5 |
| Commercial Vertical Line | -11 | -14 |
| Commercial Longline | -9 | -10 |
| Recreational Charter Private | 50 | 30 |
| Recreational Headboat | 4 | -1 |
| Length composition | 6,831 | 5,735 |
| Commercial Vertical Line | 1,550 | 1,322 |
| Commercial Longline | 1,143 | 1,015 |
| Recreational Charter Private | 792 | 692 |
| Recreational Headboat | 1,219 | 1,068 |
| Combined Video | 644 | 572 |
| RFOP Vertical Line | 1,484 | 1,064 |
| Age composition | 9,774 | 2,100 |
| Commercial Vertical Line | 4,015 | 622 |
| Commercial Longline | 5,029 | 839 |
| Recreational Charter Private | 341 | 297 |
| Recreational Headboat | 389 | 341 |

Table 6. Joint residual summary statistics for the Gulf of Mexico Scamp SEDAR 68 AP Base Model and SEDAR 68 RW Base Model. N = number of observations to compute each statistic. RMSE = root mean squared error (as a percentage), with values above 30% for joint residuals (grey rows) highlighted in red and acceptable values below 30% highlighted in green. See Carvalho et al. (2021) for additional details.

| Quantity | Statistic | SEDAR68 AP Base | AP N | SEDAR68 RW Base | RW N |
|----------------------------------|-----------|--------------------|------|--------------------|------|
| Index of Abundance | | | | | |
| pre-IFQ Commercial Vertical Line | RMSE (%) | 47.2 | 17 | 26.0 | 17 |
| Headboat | RMSE (%) | 34.4 | 32 | 19.0 | 32 |
| Combined Video | RMSE (%) | 42.5 | 21 | 23.4 | 21 |
| RFOP Vertical Line | RMSE (%) | 56.2 | 12 | 30.9 | 12 |
| Combined | RMSE (%) | 35.9 | 82 | 30.0 | 82 |
| Age | | | | | |
| Commercial Vertical Line | RMSE (%) | - | - | 16.2 | 18 |
| Commercial Longline | RMSE (%) | - | - | 15.4 | 20 |
| Recreational Charter Private | RMSE (%) | 26.5 | 14 | 18.4 | 14 |
| Recreational Headboat | RMSE (%) | 25.6 | 15 | 17.8 | 15 |
| Combined | RMSE (%) | 25 | 29 | 17.6 | 67 |
| Length | | | | | |
| Commercial Vertical Line | RMSE (%) | 3.6 | 32 | 3.4 | 32 |
| Commercial Longline | RMSE (%) | 3.7 | 31 | 3.5 | 31 |
| Recreational Charter Private | RMSE (%) | 4.3 | 22 | 4.2 | 22 |
| Recreational Headboat | RMSE (%) | 3.6 | 32 | 3.4 | 32 |
| Combined Video | RMSE (%) | 4.9 | 17 | 4.7 | 17 |
| RFOP Vertical Line | RMSE (%) | 6.1 | 11 | 5.9 | 11 |
| Combined | RMSE (%) | 4.5 | 145 | 4.6 | 145 |

Table 7. Runs tests summary statistics for the Gulf of Mexico Scamp SEDAR 68 AP Base Model and SEDAR 68 RW Base Model. N = number of observations to compute each statistic. P-values less than 0.05% (in red) indicate non-randomly distributed residuals whereas p-values greater than 0.05% (in green) provide support for randomly distributed residuals. See Carvalho et al. (2021) for additional details.

| Quantity | Statistic | SEDAR68 AP Base | AP N | SEDAR68 RW Base | RW N |
|----------------------------------|-----------|--------------------|------|--------------------|------|
| Index of Abundance | | | | | |
| pre-IFQ Commercial Vertical Line | p-value | 0 | 17 | 0.003 | 17 |
| Headboat | p-value | 0.36 | 32 | 0.536 | 32 |
| Combined Video | p-value | 0.089 | 21 | 0.323 | 21 |
| RFOP Vertical Line | p-value | 0.058 | 12 | 0.058 | 12 |
| Age | | | | | |
| Commercial Vertical Line | p-value | - | - | 0.049 | 18 |
| Commercial Longline | p-value | - | - | 0.002 | 20 |
| Recreational Charter Private | p-value | 0.001 | 14 | 0.001 | 14 |
| Recreational Headboat | p-value | 0.653 | 15 | 0.275 | 15 |
| Length | | | | | |
| Commercial Vertical Line | p-value | 0.002 | 32 | 0.062 | 32 |
| Commercial Longline | p-value | 0.076 | 31 | 0.066 | 31 |
| Recreational Charter Private | p-value | 0.77 | 22 | 0.770 | 22 |
| Recreational Headboat | p-value | 0.007 | 32 | 0.007 | 32 |
| Combined Video | p-value | 0.019 | 17 | 0.019 | 17 |
| RFOP Vertical Line | p-value | 0.907 | 11 | 0.907 | 11 |

Table 8. Retrospective analysis and retrospective forecast spawning stock biomass (SSB) and fishing mortality (F) for the last five terminal years and combined (grey rows) for the Gulf of Mexico Scamp SEDAR 68 AP Base Model and SEDAR 68 RW Base Model. N = number of observations to compute each statistic. Values outside the acceptable range of -0.15 to 0.2 for longer-lived species (Hurtado-Ferro et al. 2015) are highlighted in red and indicate an undesirable retrospective pattern. Values within -0.15 to 0.2 are highlighted in green and are considered acceptable levels of retrospective bias. See Carvalho et al. (2021) for additional details.

| Quantity | SEDAR68 AP Base | AP N | SEDAR68 RW Base | RW N |
|-------------------------------|--------------------|------|--------------------|------|
| Retro SSB (2016) | -0.054 | 1 | -0.109 | 1 |
| Retro SSB (2015) | -0.056 | 1 | -0.129 | 1 |
| Retro SSB (2014) | -0.235 | 1 | -0.331 | 1 |
| Retro SSB (2013) | -0.166 | 1 | -0.258 | 1 |
| Retro SSB (2012) | -0.188 | 1 | -0.272 | 1 |
| Retro SSB (Combined) | -0.14 | 5 | -0.220 | 5 |
| Retro Forecast SSB (2016) | -0.039 | 1 | -0.102 | 1 |
| Retro Forecast SSB (2015) | -0.055 | 1 | -0.139 | 1 |
| Retro Forecast SSB (2014) | -0.202 | 1 | -0.336 | 1 |
| Retro Forecast SSB (2013) | -0.175 | 1 | -0.295 | 1 |
| Retro Forecast SSB (2012) | -0.198 | 1 | -0.313 | 1 |
| Retro Forecast SSB (Combined) | -0.134 | 5 | -0.237 | 5 |
| Retro F (2016) | 0.042 | 1 | 0.084 | 1 |
| Retro F (2015) | 0.195 | 1 | 0.266 | 1 |
| Retro F (2014) | 0.267 | 1 | 0.497 | 1 |
| Retro F (2013) | 0.272 | 1 | 0.518 | 1 |
| Retro F (2012) | 0.234 | 1 | 0.477 | 1 |
| Retro F (Combined) | 0.202 | 5 | 0.368 | 5 |
| Retro Forecast F (2016) | 0.053 | 1 | 0.075 | 1 |
| Retro Forecast F (2015) | 0.155 | 1 | 0.225 | 1 |
| Retro Forecast F (2014) | 0.282 | 1 | 0.611 | 1 |
| Retro Forecast F (2013) | 0.052 | 1 | 0.382 | 1 |
| Retro Forecast F (2012) | 0.411 | 1 | 0.818 | 1 |
| Retro Forecast F (Combined) | 0.191 | 5 | 0.422 | 5 |

Table 9. Hindcast cross-validation summary statistics for the Gulf of Mexico Scamp SEDAR 68 AP Base Model and SEDAR 68 RW Base Model. N = number of observations to compute each statistic. MASE = mean absolute scaled error, with values < 1 (in green) indicative of superior prediction skill over a naïve baseline forecast (random walk) and values > 1 (in red) indicative of poor prediction skill. See Carvalho et al. (2021) for additional details.

| Quantity | Statistic | SEDAR68 AP Base | AP N | SEDAR68 RW Base | RW N |
|----------------------------------|-----------|--------------------|------|--------------------|------|
| Index of Abundance | | | | | |
| pre-IFQ Commercial Vertical Line | MASE | | 0 | | 0 |
| Headboat | MASE | 0.91 | 5 | 0.76 | 5 |
| Combined Video | MASE | 1.09 | 5 | 2.58 | 5 |
| RFOP Vertical Line | MASE | 2.75 | 5 | 3.50 | 5 |
| Joint | MASE | 1.57 | 15 | 2.08 | 15 |
| Age | | | | | |
| Commercial Vertical Line | MASE | - | - | 1.20 | 5 |
| Commercial Longline | MASE | - | - | 0.97 | 5 |
| Recreational Charter Private | MASE | 2.48 | 4 | 2.35 | 4 |
| Recreational Headboat | MASE | 0.62 | 4 | 0.67 | 4 |
| Joint | MASE | 1.2 | 8 | 1.17 | 18 |
| Length | | | | | |
| Commercial Vertical Line | MASE | 0.82 | 5 | 0.89 | 5 |
| Commercial Longline | MASE | 0.12 | 5 | 0.17 | 5 |
| Recreational Charter Private | MASE | 0.23 | 5 | 0.30 | 5 |
| Recreational Headboat | MASE | 0.8 | 5 | 0.77 | 5 |
| Combined Video | MASE | 1.03 | 5 | 1.24 | 5 |
| RFOP Vertical Line | MASE | 0.71 | 5 | 0.70 | 5 |
| Joint | MASE | 0.5 | 30 | 0.54 | 30 |

10. Figures

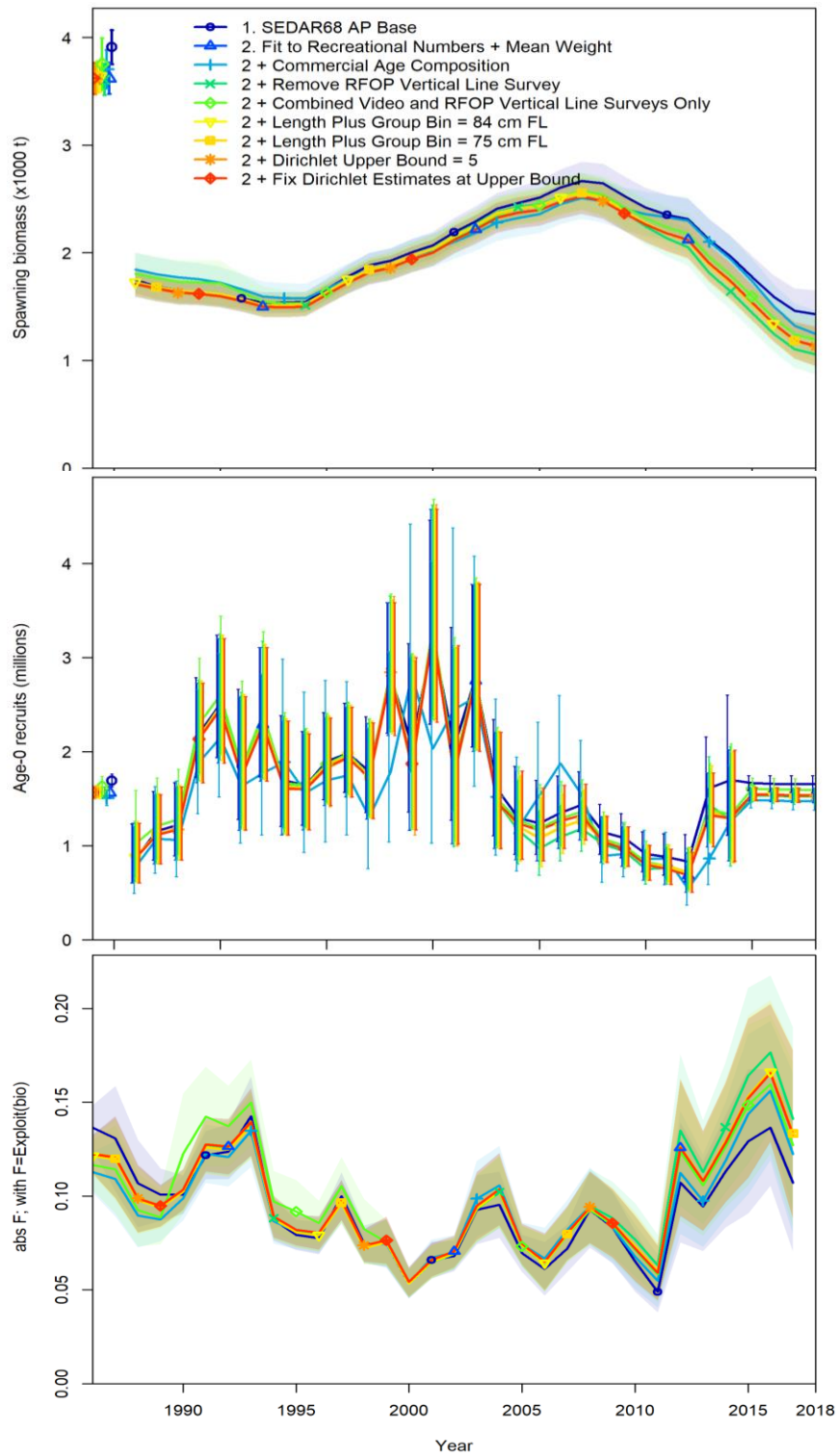

Figure 1. Estimates of spawning stock biomass (1,000s of metric tons; top panel), recruitment (millions of fish; middle panel), and fishing mortality (total biomass killed age 3+ / total biomass age 3+; bottom panel) for the Homework 1 sensitivity runs conducted for Gulf of Mexico Scamp.

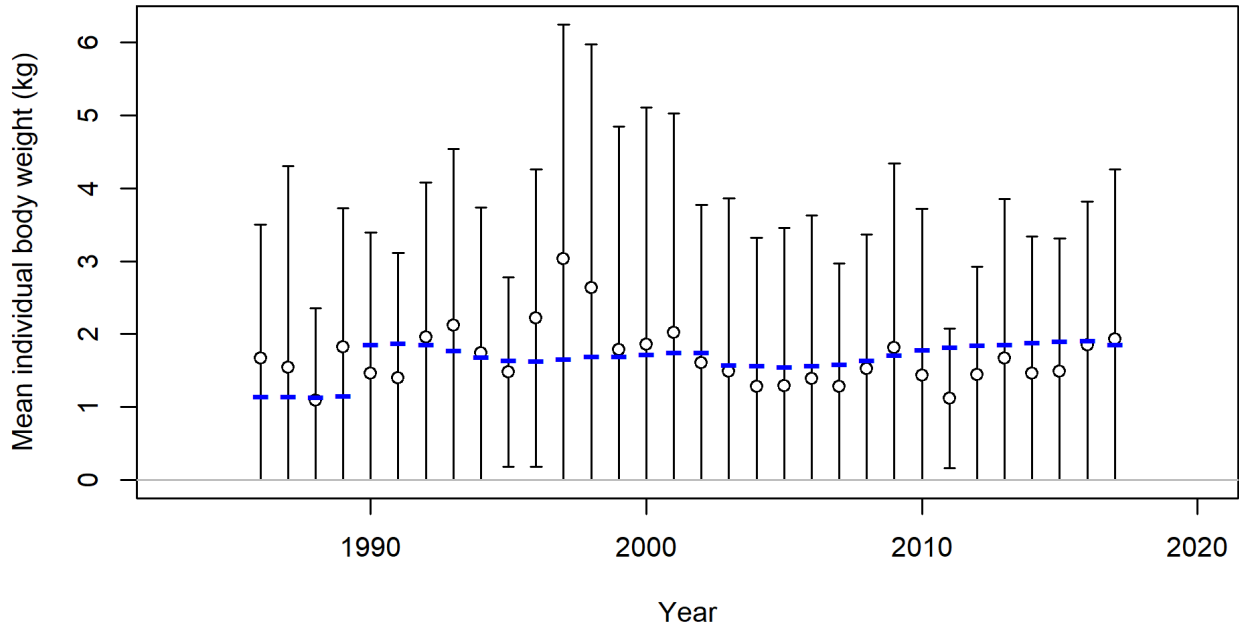

Figure 2. Input (observed mean weight; dots with 95% confidence intervals) and expected (blue lines) mean body weight of Scamp landed by the Recreational Charter Private fleet in the Gulf of Mexico. This run fit to both the recreational landings in numbers and the mean weight of landed Scamp for each recreational fleet.

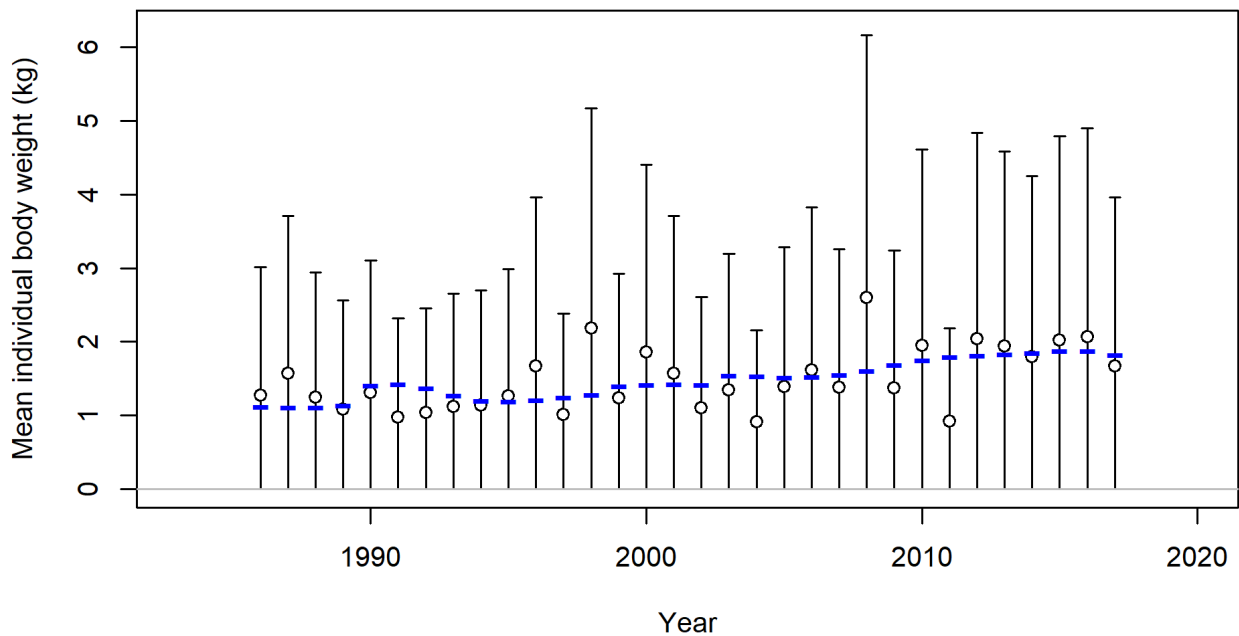

Figure 3. Input (observed mean weight; dots with 95% confidence intervals) and expected (blue lines) mean body weight of Scamp landed by the Recreational Headboat fleet in the Gulf of Mexico. This run fit to both the recreational landings in numbers and the mean weight of landed Scamp for each recreational fleet.

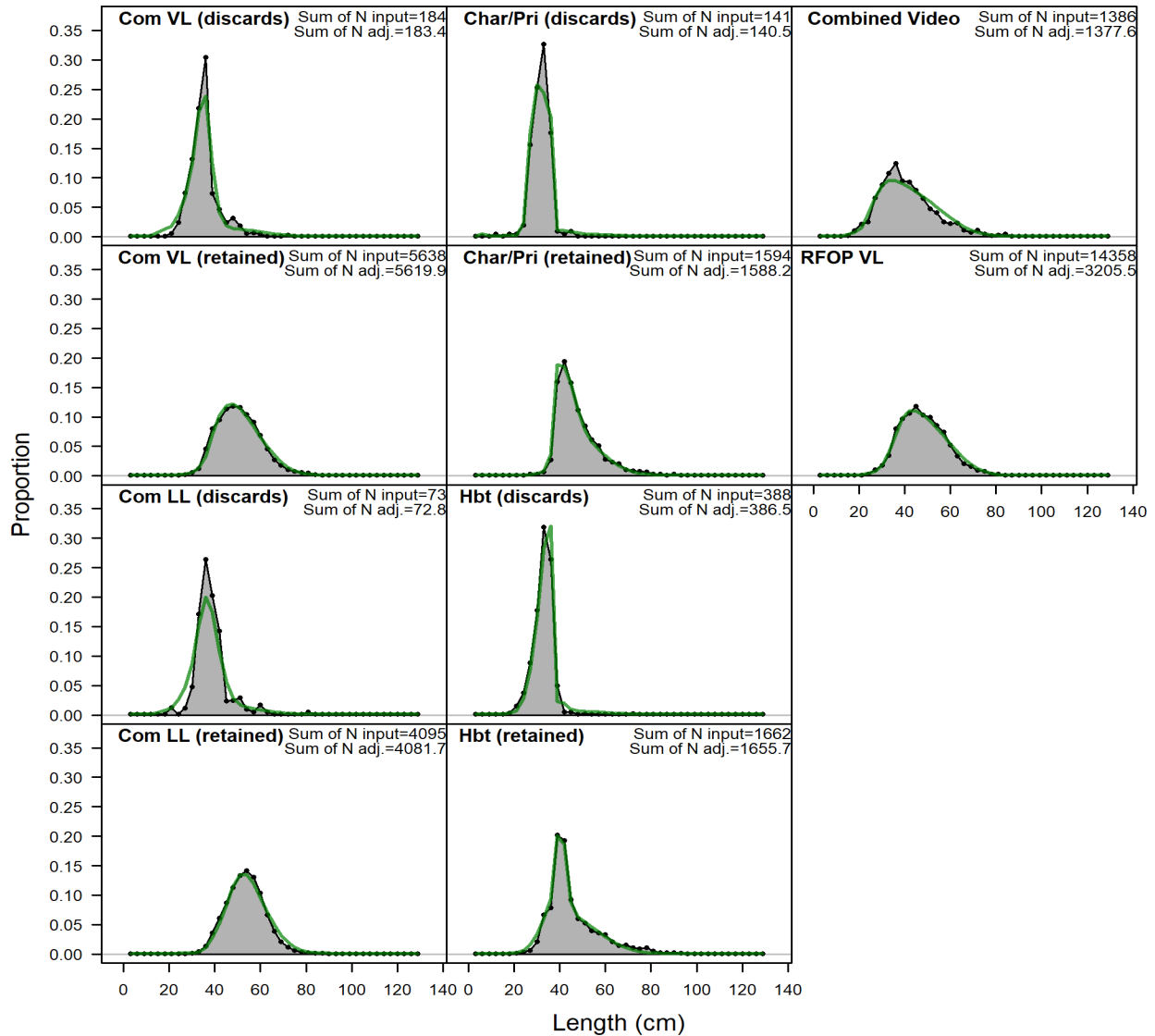

Figure 4. Model fits to the length compositions of discarded or landed (i.e., retained) Scamp aggregated across years within a given fleet or survey in the Gulf of Mexico when fitting to commercial age compositions. Green lines represent expected length compositions, while grey shaded regions represent observed length compositions. The input (N_{input}) and adjusted (N_{adj}) sample sizes are provided in the upper right corner of each panel. Abbreviations include: Commercial Vertical Line (Com VL), Commercial Longline (Com LL), Recreational Charter Private (Char/Pri), Recreational Headboat (Hbt), and the Reef Fish Observer Program Vertical Line Survey (RFOP VL).

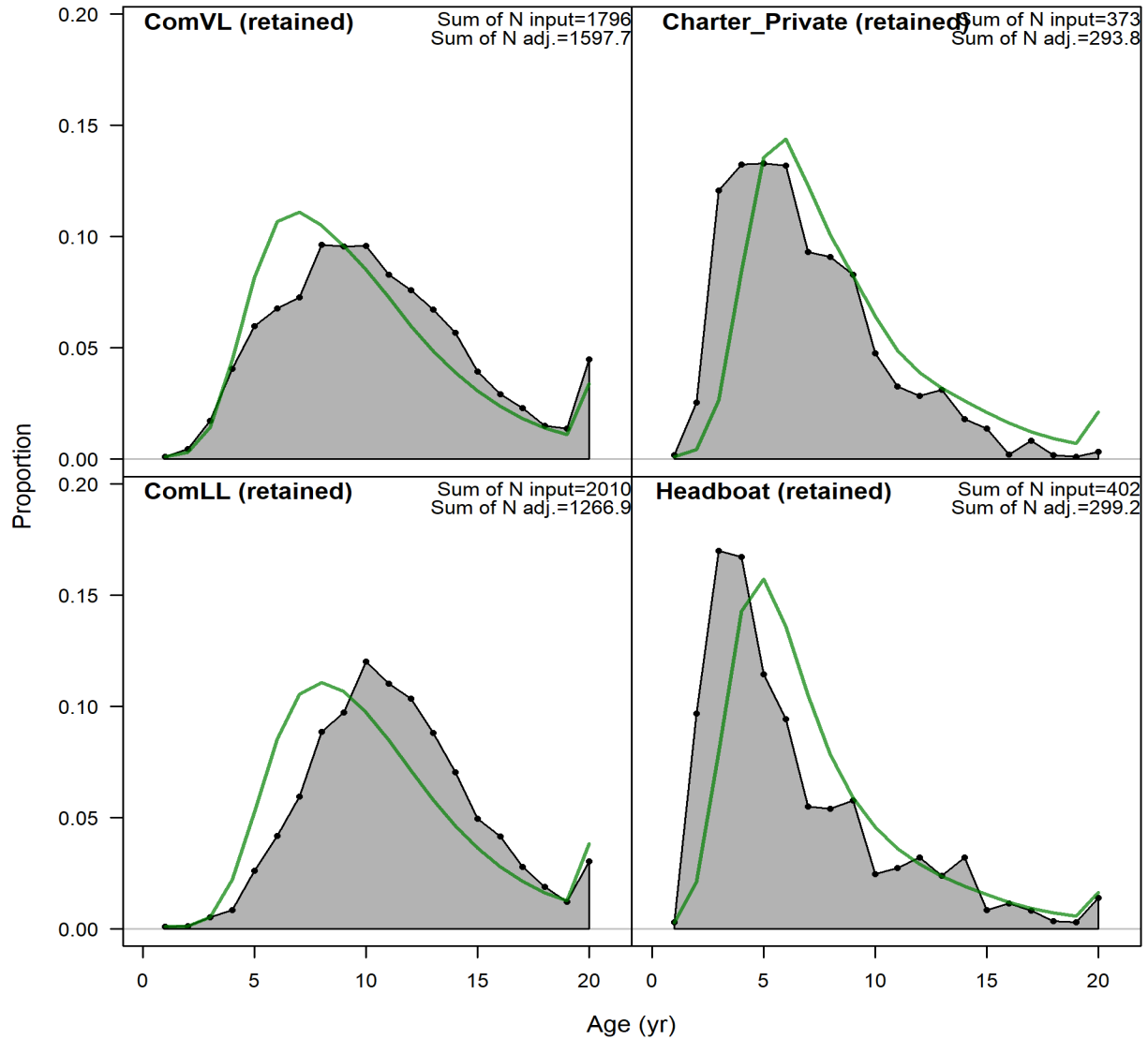

Figure 5. Model fits to the age compositions of landed Scamp aggregated across years within a given fleet in the Gulf of Mexico when fitting to commercial age compositions. Green lines represent expected age compositions, while grey shaded regions represent observed age compositions. The input (*N* input) and adjusted (*N* adj) sample sizes are provided in the upper right corner of each panel. Abbreviations include: Commercial Vertical Line (ComVL) and Commercial Longline (ComLL).

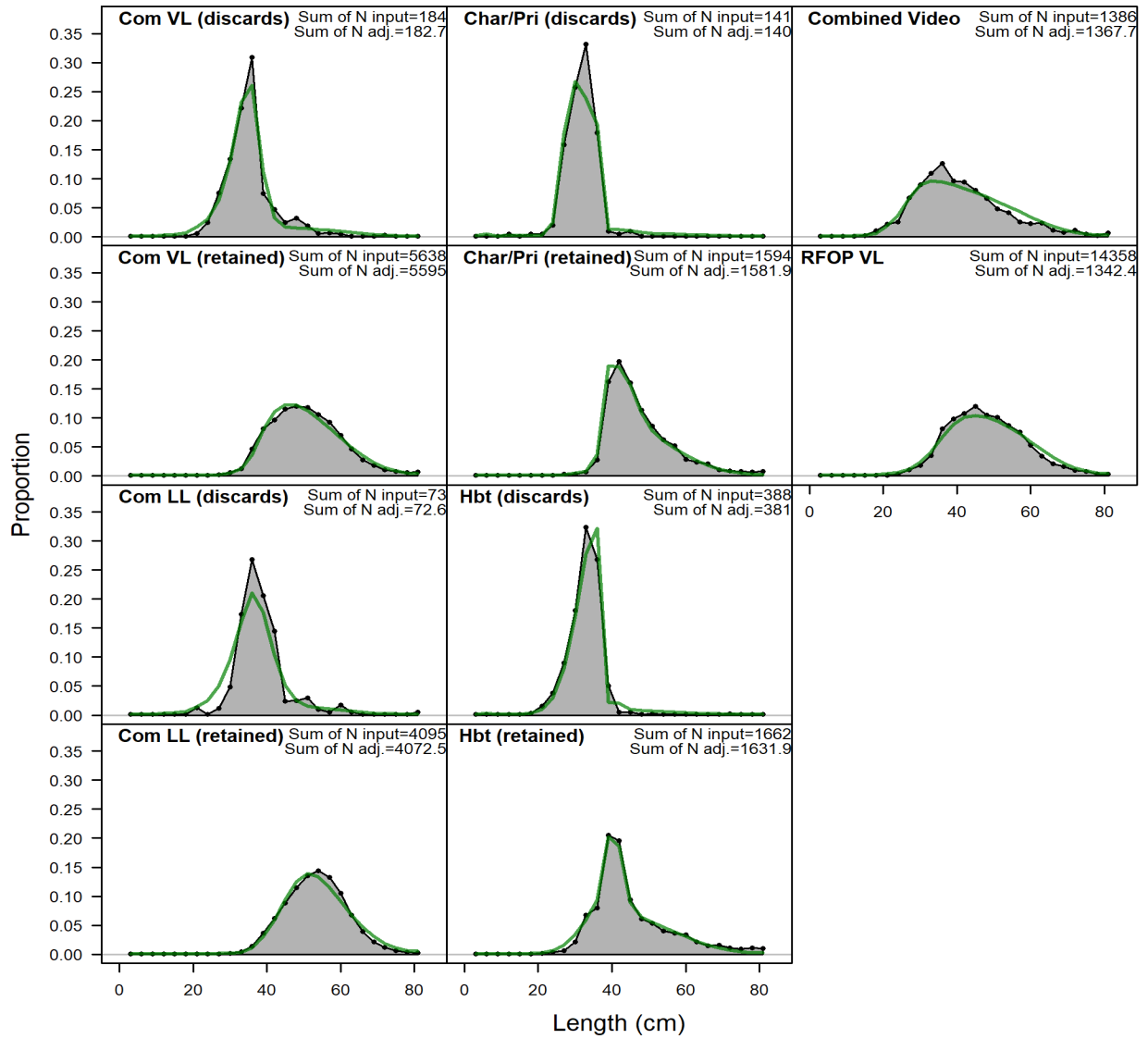

Figure 6. Model fits to the length compositions of discarded or landed (i.e., retained) Scamp aggregated across years within a given fleet or survey in the Gulf of Mexico when fitting to length compositions with a plus group of 84 cm Fork Length. Green lines represent expected length compositions, while grey shaded regions represent observed length compositions. The input (N input) and adjusted (N adj) sample sizes are provided in the upper right corner of each panel. Abbreviations include: Commercial Vertical Line (Com VL), Commercial Longline (Com LL), Recreational Charter Private (Char/Pri), Recreational Headboat (Hbt), and the Reef Fish Observer Program Vertical Line Survey (RFOP VL).

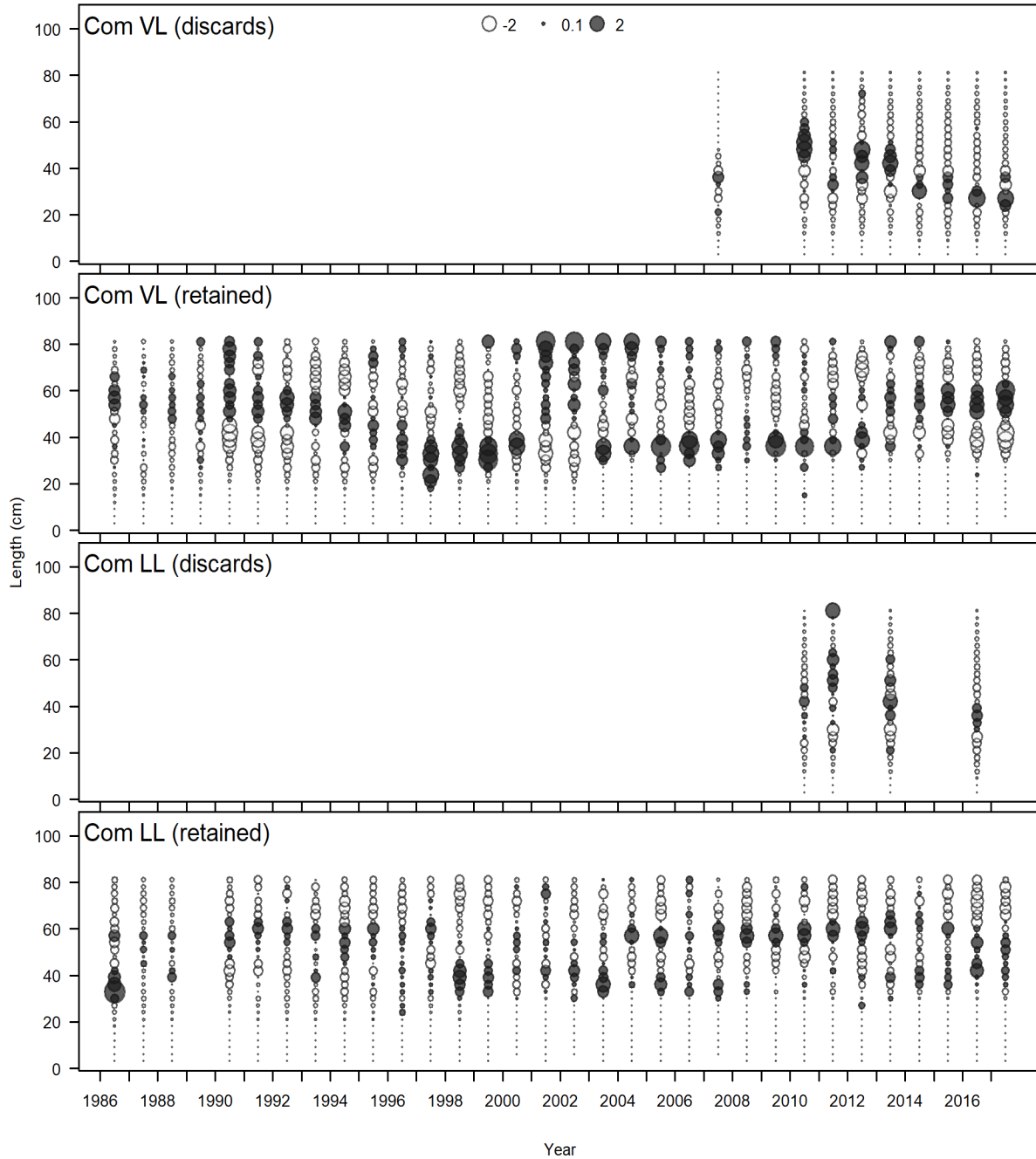

Figure 7. Pearson residuals for length compositions of discarded and landed Scamp for the Commercial Vertical Line (Com VL) and the Commercial Longline (Com LL) in the Gulf of Mexico when fitting to length compositions with a plus group of 84 cm Fork Length. Closed bubbles are positive residuals ($Obs > Exp$) and open bubbles are negative residuals ($Obs < Exp$).

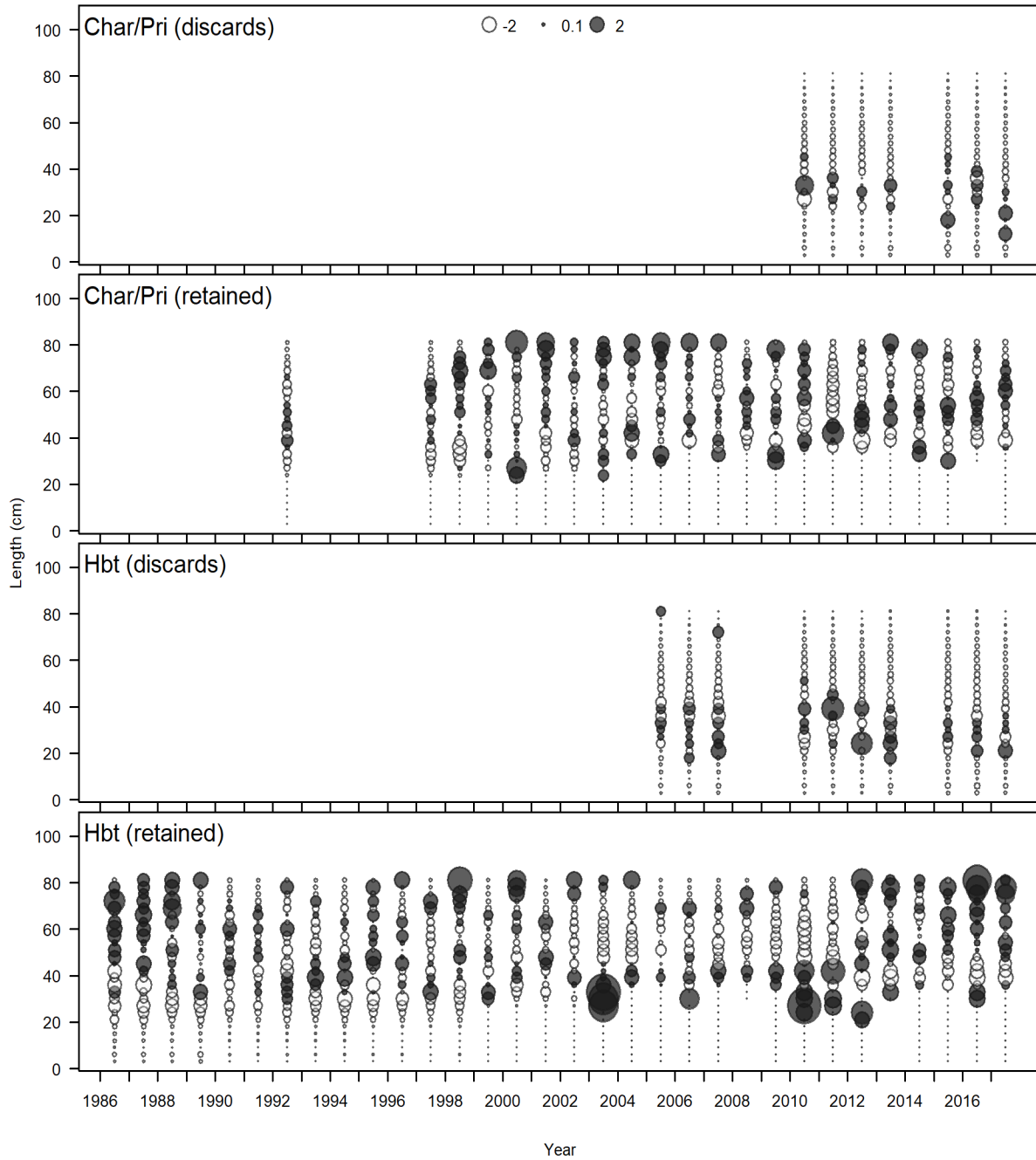

Figure 7 Continued. Pearson residuals for length compositions of discarded and landed Scamp for the Recreational Charter Private (Char/Pri) and the Recreational Headboat (Hbt) in the Gulf of Mexico when fitting to length compositions with a plus group of 84 cm Fork Length. Closed bubbles are positive residuals ($Obs > Exp$) and open bubbles are negative residuals ($Obs < Exp$).

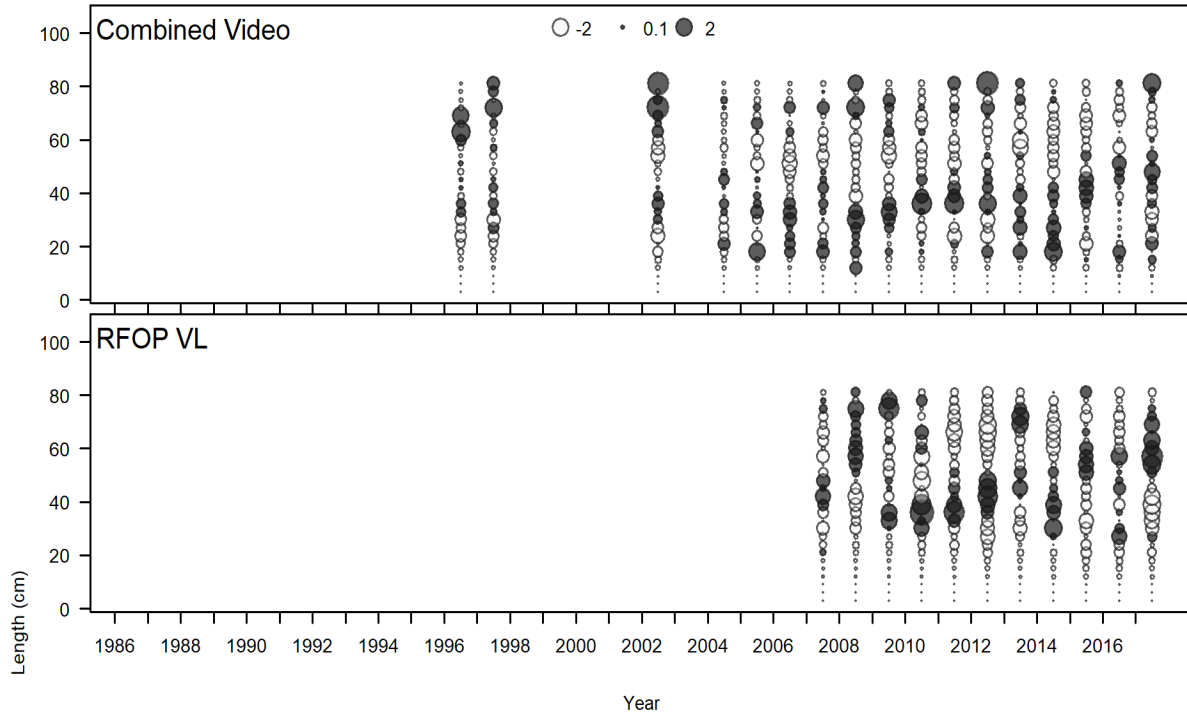

Figure 7 Continued. Pearson residuals for length compositions of Scamp captured by the Combined Video Survey and the RFOP Vertical Line Survey (RFOP VL) in the Gulf of Mexico when fitting to length compositions with a plus group of 84 cm Fork Length. Closed bubbles are positive residuals ($Obs > Exp$) and open bubbles are negative residuals ($Obs < Exp$).

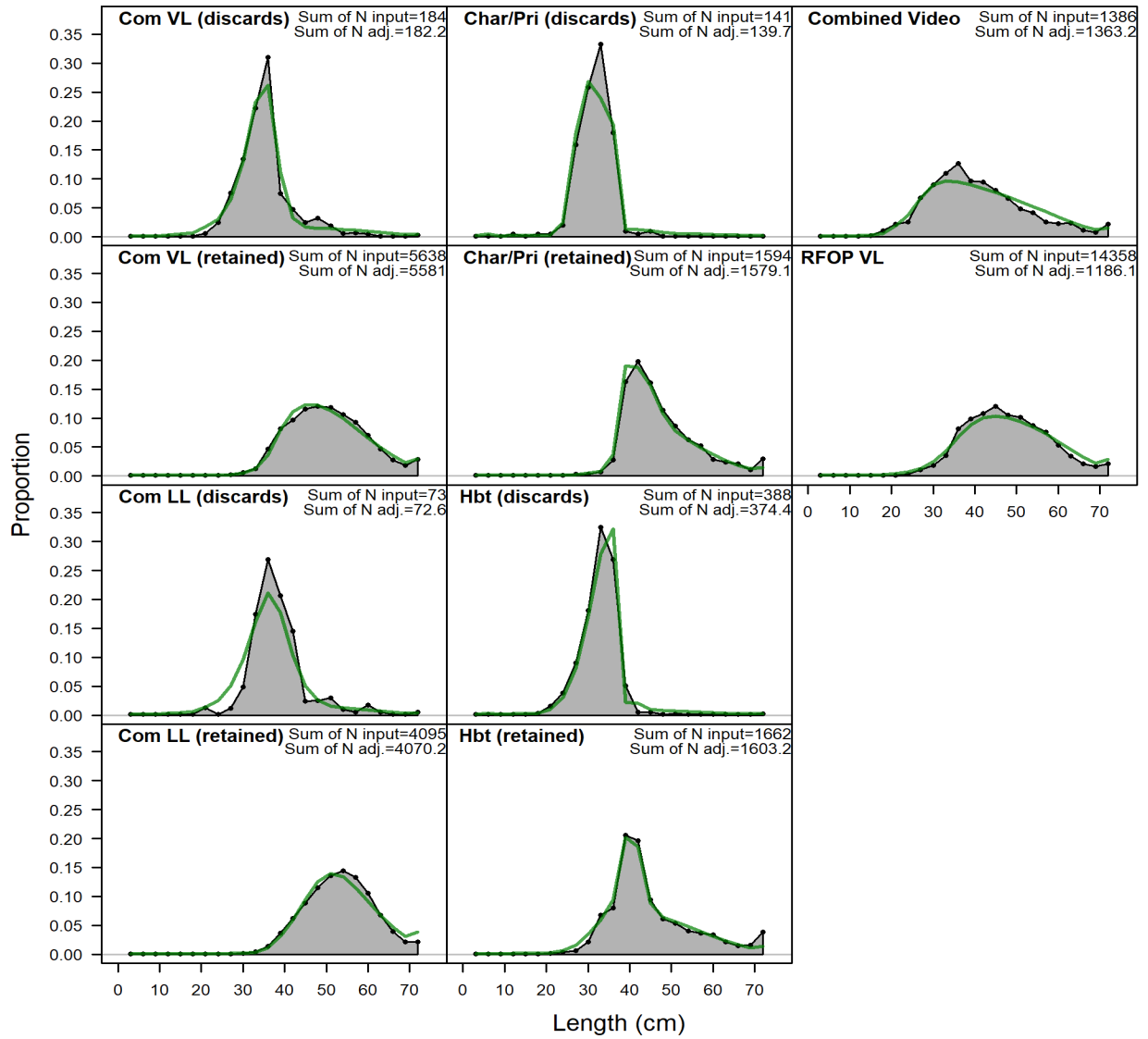

Figure 8. Model fits to the length compositions of discarded or landed (i.e., retained) Scamp aggregated across years within a given fleet or survey in the Gulf of Mexico when fitting to length compositions with a plus group of 75 cm Fork Length. Green lines represent expected length compositions, while grey shaded regions represent observed length compositions. The input (N input) and adjusted (N adj) sample sizes are provided in the upper right corner of each panel. Abbreviations include: Commercial Vertical Line (Com VL), Commercial Longline (Com LL), Recreational Charter Private (Char/Pri), Recreational Headboat (Hbt), and the Reef Fish Observer Program Vertical Line (RFOP VL).

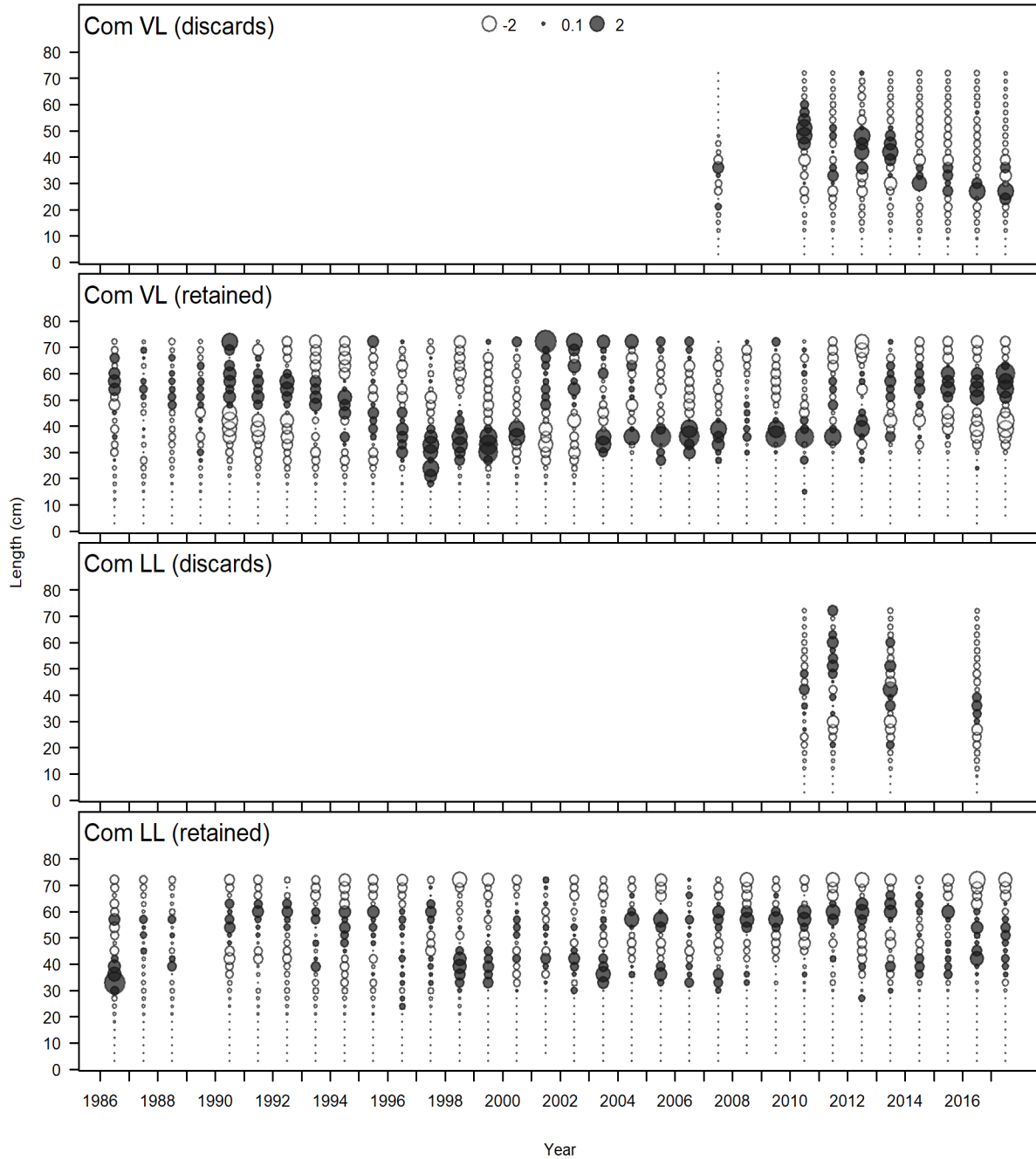

Figure 9. Pearson residuals for length compositions of discarded and landed Scamp for the Commercial Vertical Line (Com VL) and the Commercial Longline (Com LL) in the Gulf of Mexico when fitting to length compositions with a plus group of 75 cm Fork Length. Closed bubbles are positive residuals ($Obs > Exp$) and open bubbles are negative residuals ($Obs < Exp$).

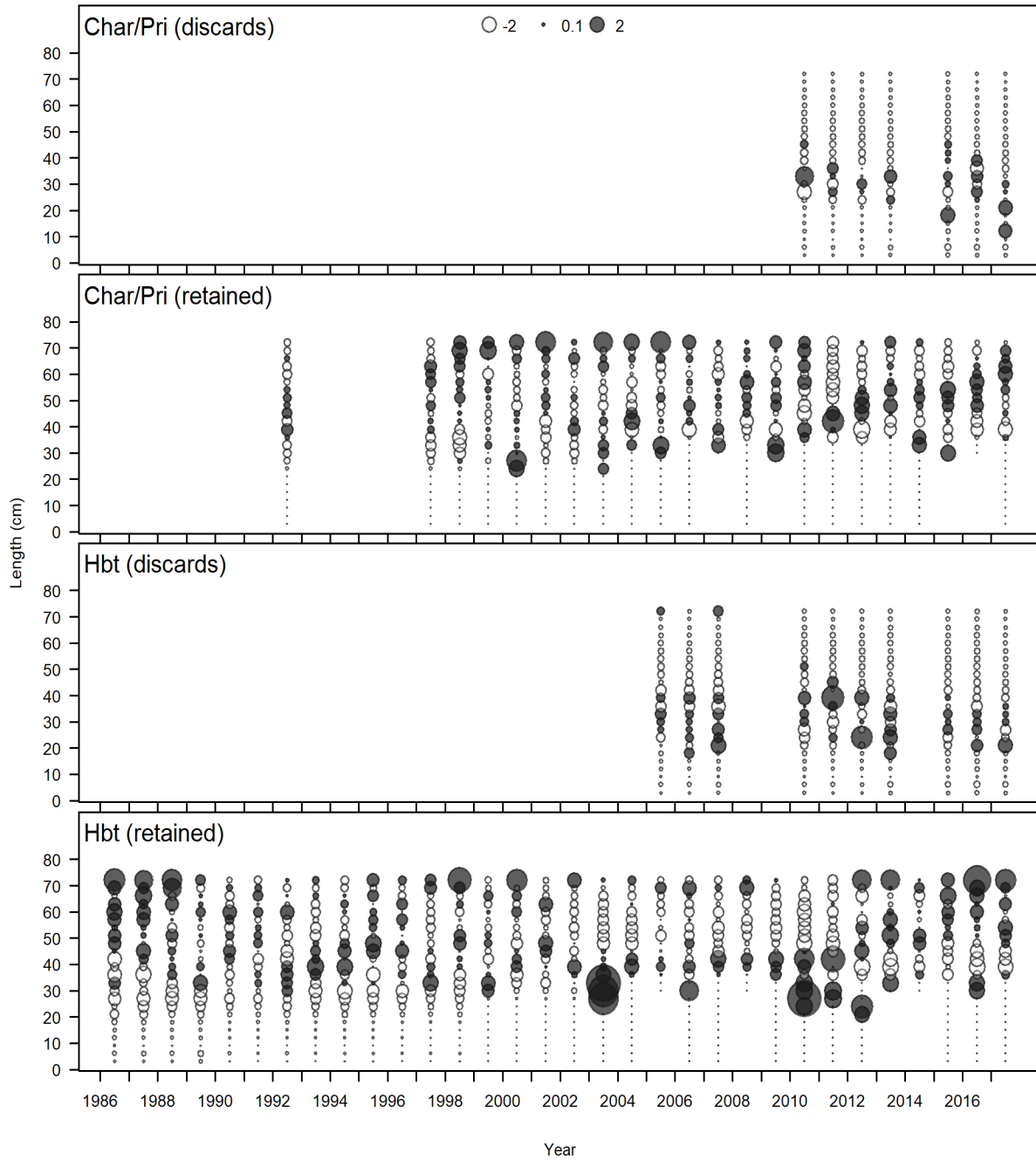

Figure 9 Continued. Pearson residuals for length compositions of discarded and landed Scamp for the Recreational Charter Private (Char/Pri) and the Recreational Headboat (Hbt) in the Gulf of Mexico when fitting to length compositions with a plus group of 75 cm Fork Length. Closed bubbles are positive residuals ($Obs > Exp$) and open bubbles are negative residuals ($Obs < Exp$).

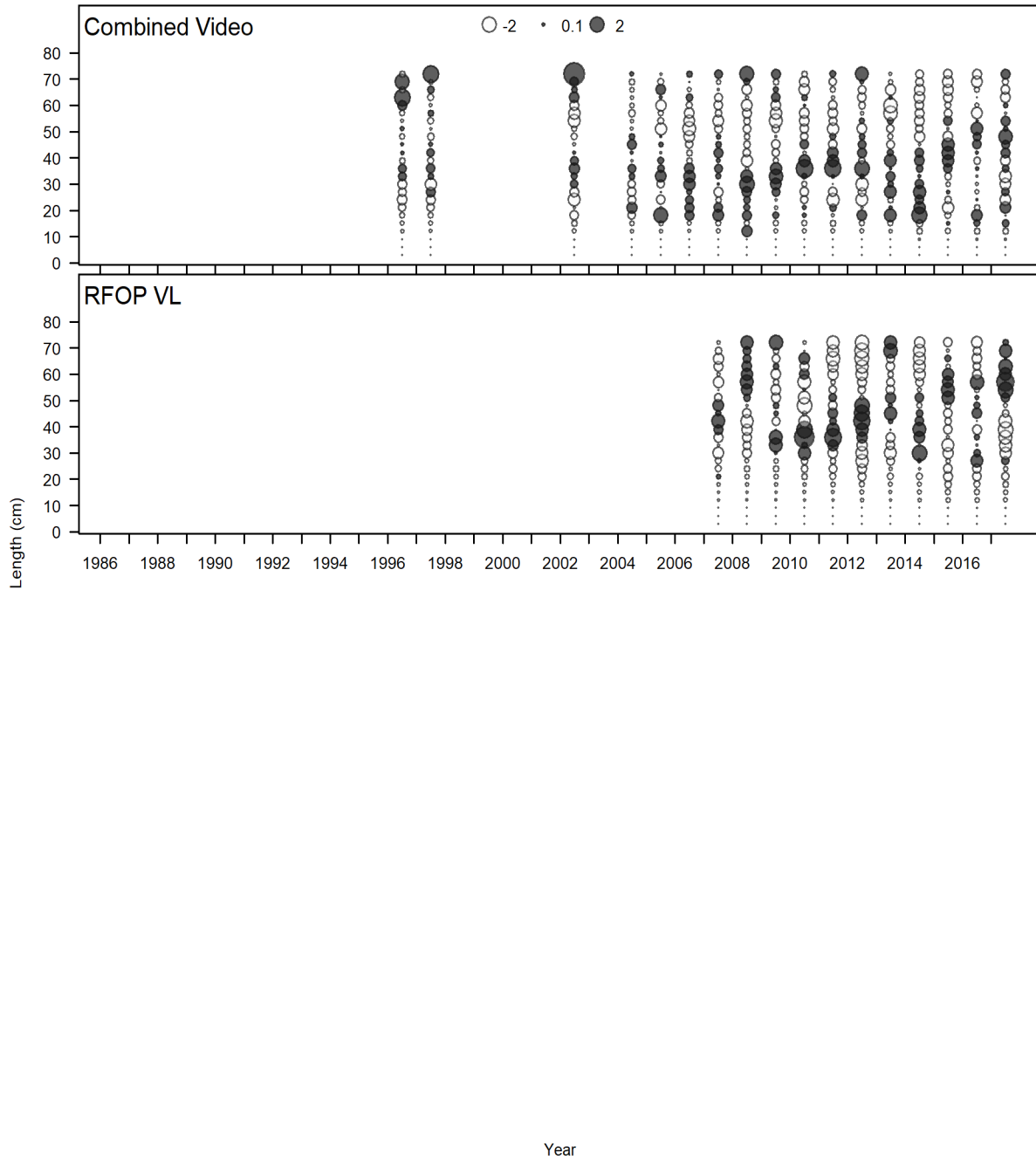

Figure 9 Continued. Pearson residuals for length compositions of captured Scamp for the Combined Video Survey and the RFOP Vertical Line Survey (RFOP VL) in the Gulf of Mexico when fitting to length compositions with a plus group of 75 cm Fork Length. Closed bubbles are positive residuals ($Obs > Exp$) and open bubbles are negative residuals ($Obs < Exp$).

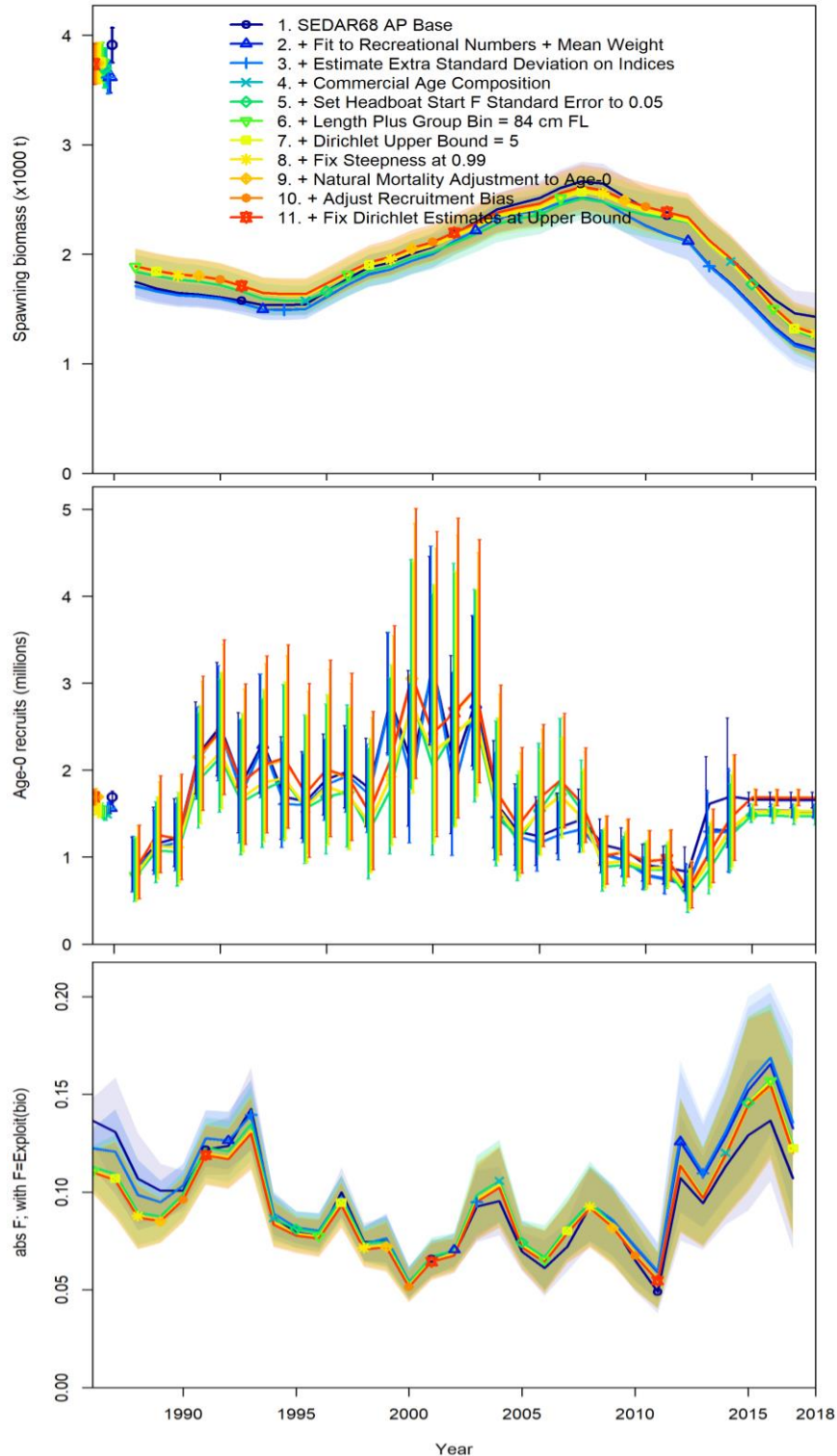

Figure 10. Estimates of spawning stock biomass (1,000s of metric tons; top panel), recruitment (millions of fish; middle panel), and fishing mortality (total biomass killed age 3+ / total biomass age 3+; bottom panel) for runs building to the Gulf of Mexico Scamp SEDAR 68 RW Base Model. Note that Model 11 is the SEDAR 68 RW Base Model In Progress presented during the RW.

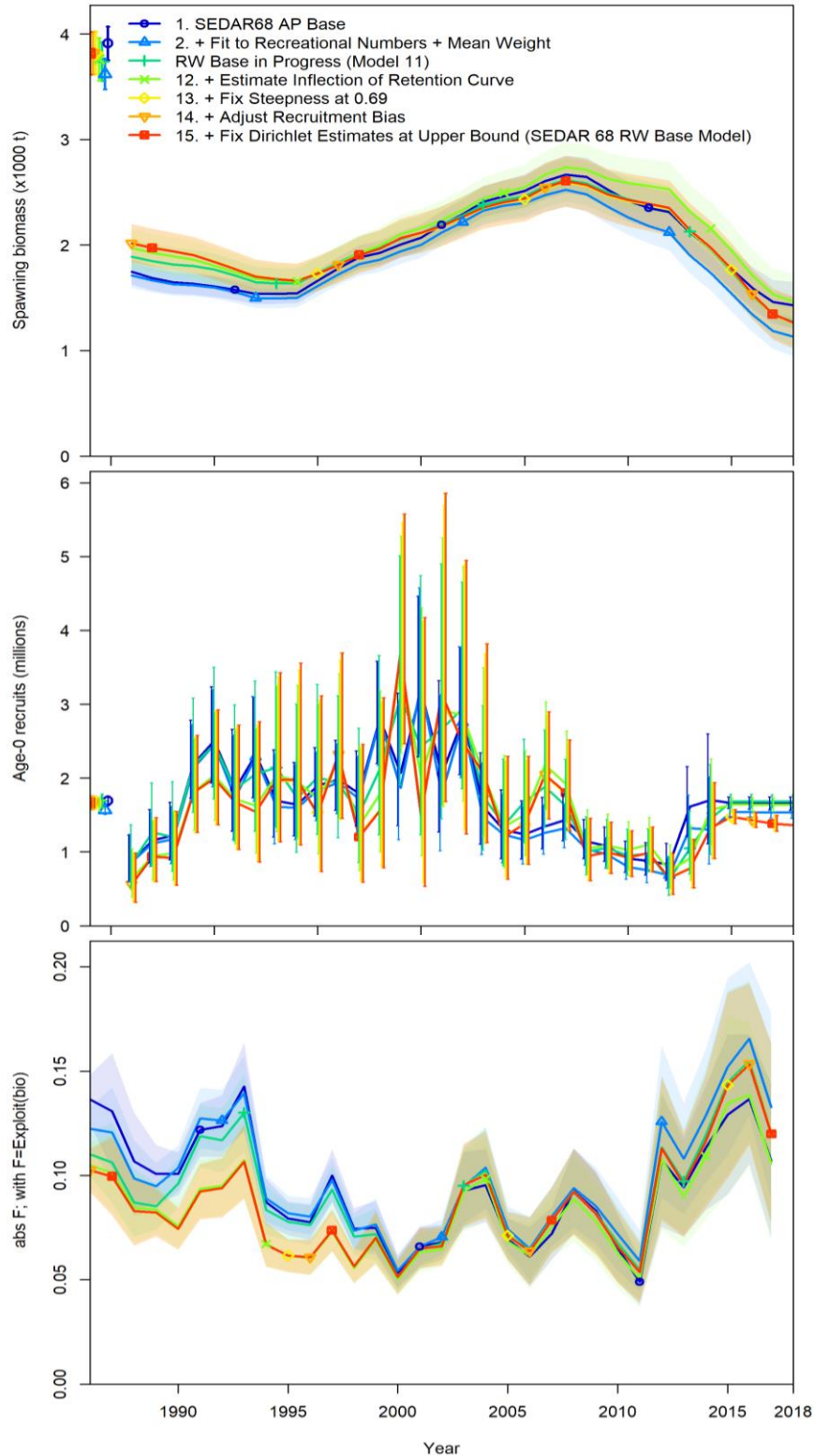

Figure 11. Estimates of spawning stock biomass (1,000s of metric tons; top panel), recruitment (millions of fish; middle panel), and fishing mortality (total biomass killed age 3+ / total biomass age 3+; bottom panel) for runs building to the Gulf of Mexico Scamp SEDAR 68 RW Base Model (Model 15).

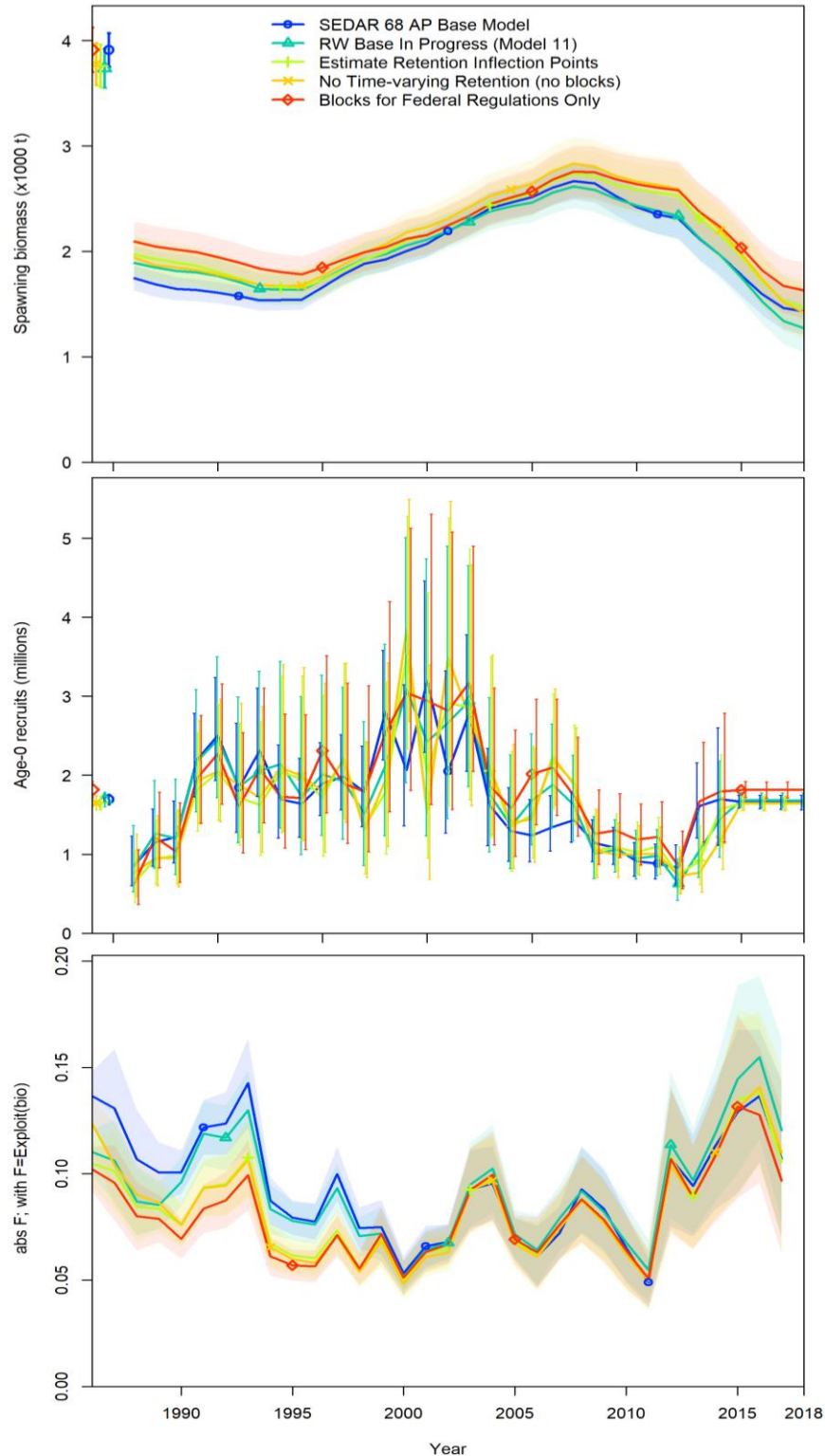

Figure 12. Estimates of spawning stock biomass (1,000s of metric tons; top panel), recruitment (millions of fish; middle panel), and fishing mortality (total biomass killed age 3+ / total biomass age 3+; bottom panel) for sensitivity runs investigating time-varying retention in the Gulf of Mexico Scamp SEDAR 68 RW Base Model In Progress (Model 11).

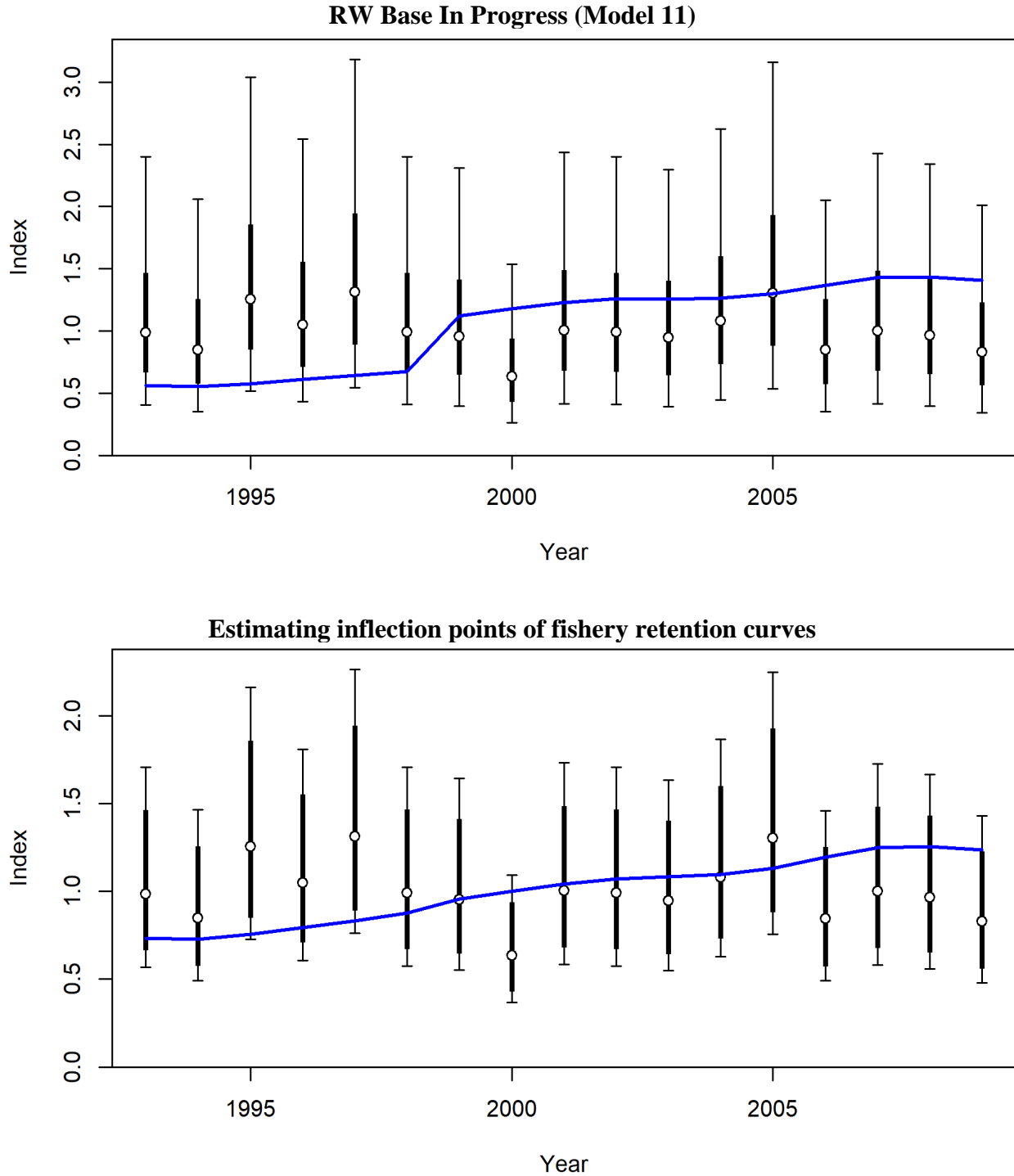

Figure 13. Comparison of input (dots with 95% confidence intervals) and expected (blue lines) indices of relative abundance for Gulf of Mexico Scamp retained by the Commercial Vertical Line fleet prior to the implementation of the Grouper-Tilefish Individual Fishing Quota. The SEDAR 68 RW Base Model In Progress (Model 11) is compared to the sensitivity run estimating the inflection point for each fishery retention curve. Thicker lines indicate input uncertainty before the addition of extra uncertainty.

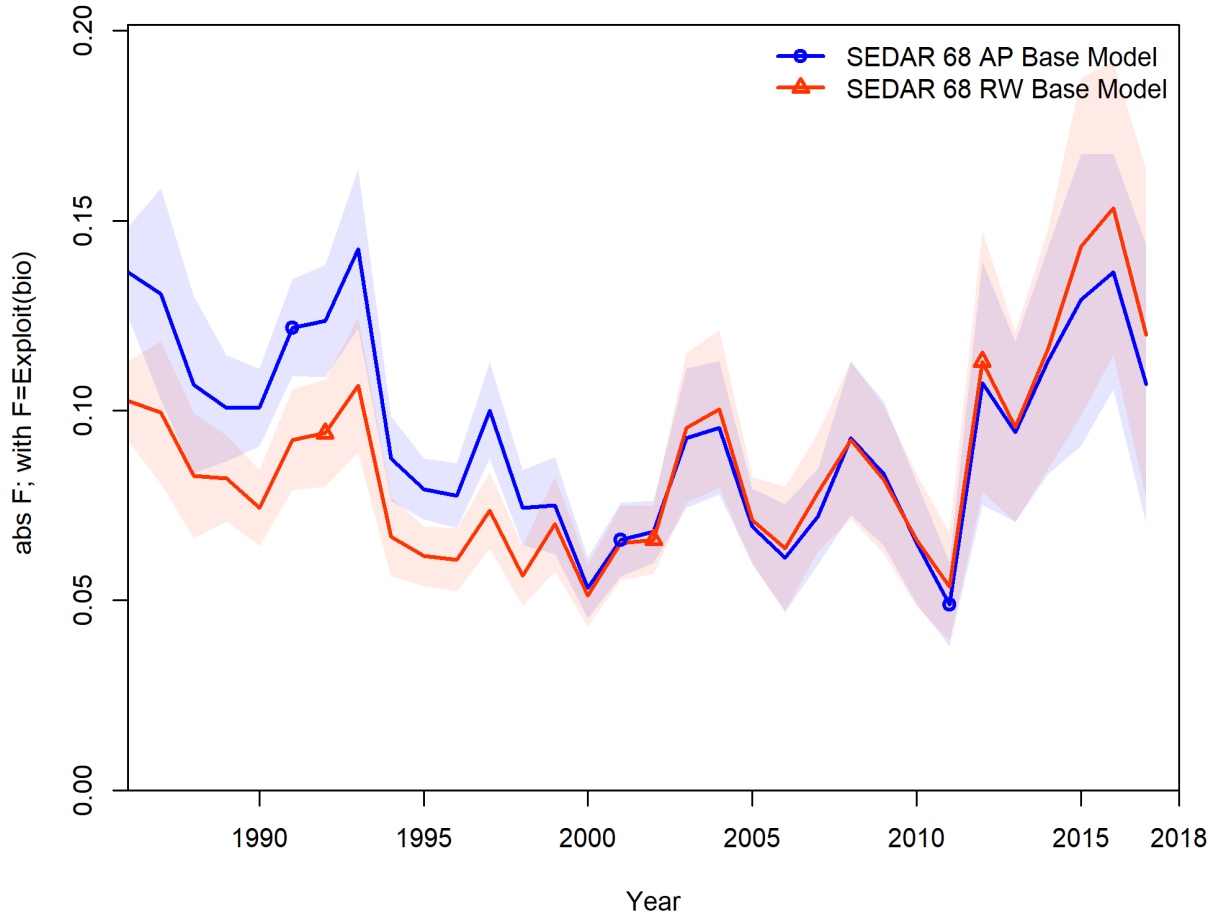

Figure 14. Comparison of annual exploitation rates (total biomass killed age 3+ / total biomass age 3+) with ~95% asymptotic intervals (shaded region) for Gulf of Mexico Scamp.

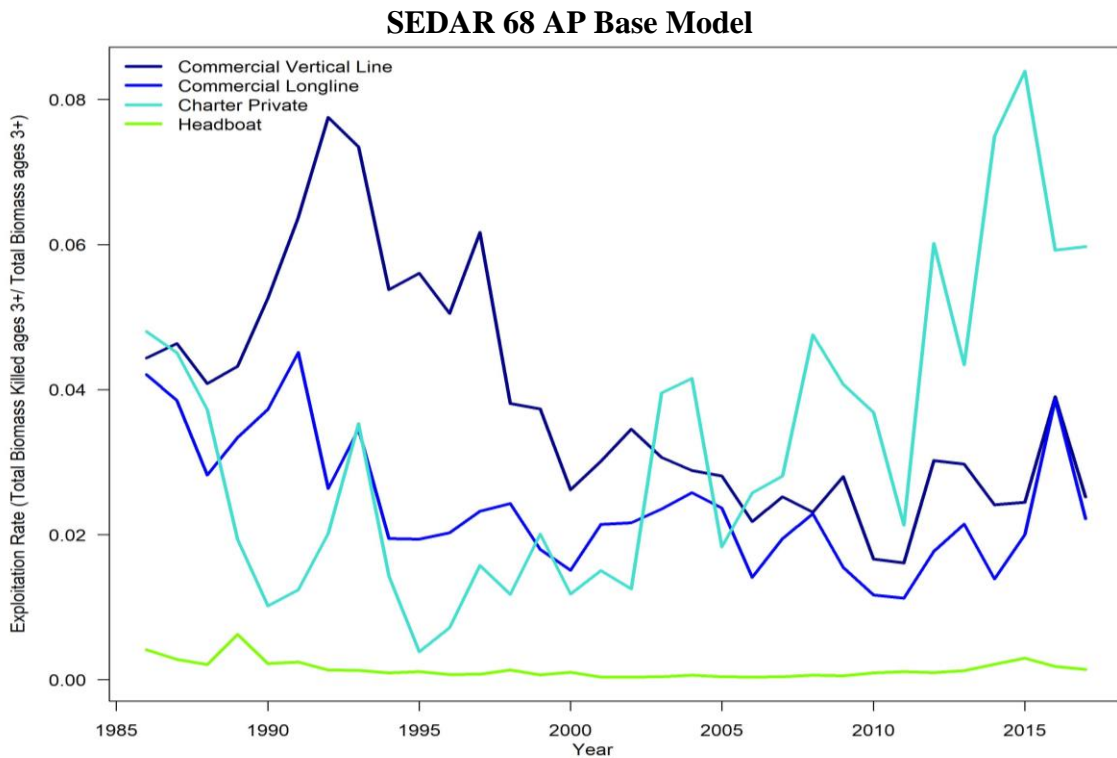
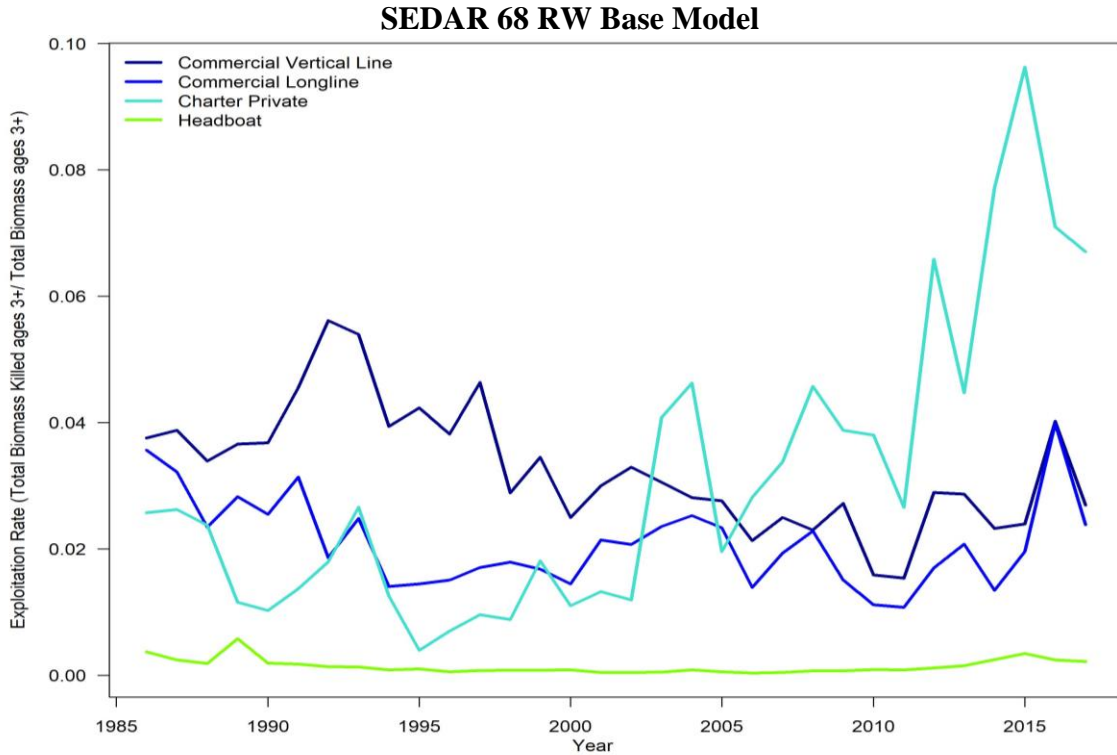

Figure 15. Comparison of annual exploitation rates (total biomass killed age 3+ / total biomass age 3+) by fleet for Gulf of Mexico Scamp.

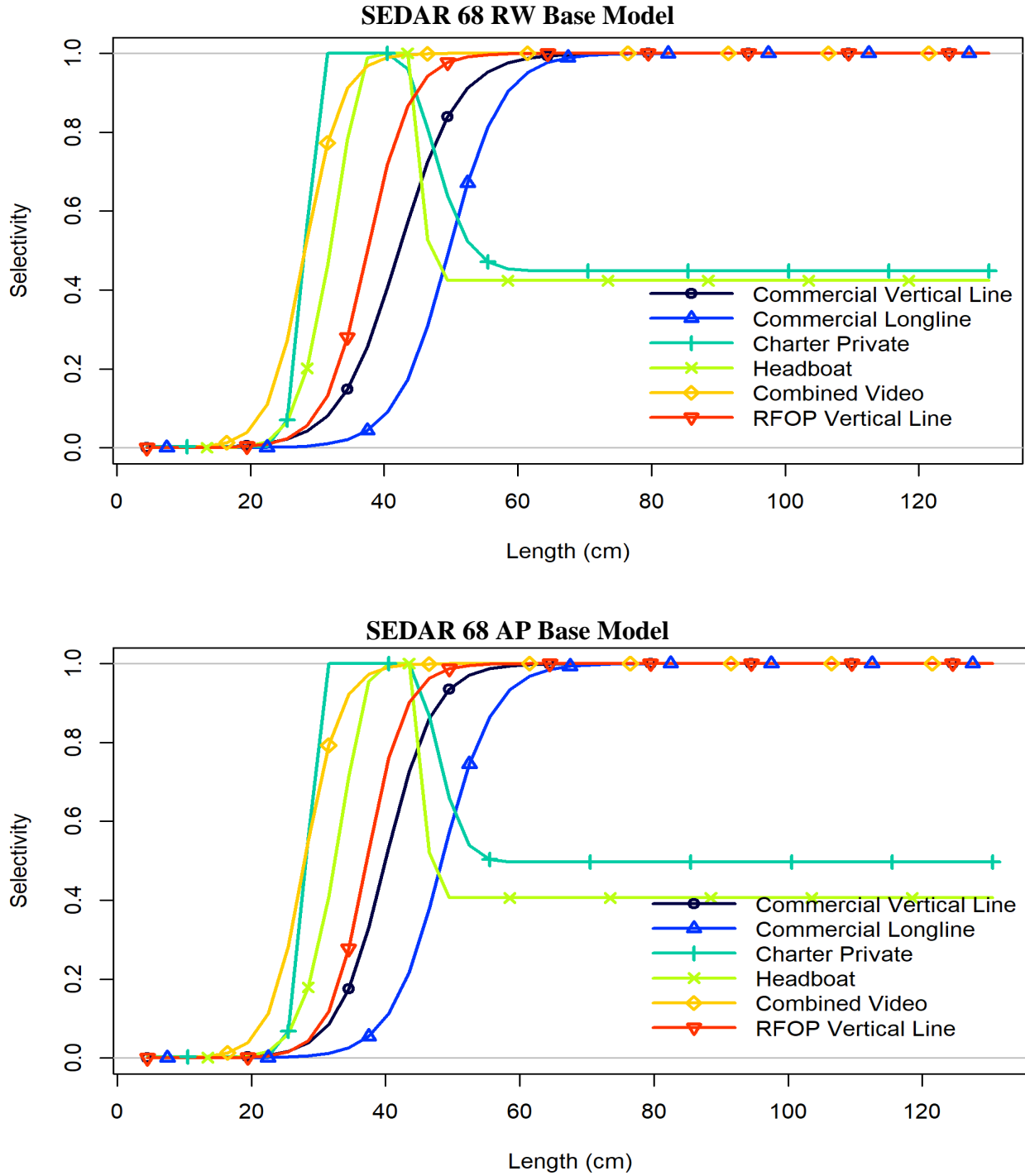

Figure 16. Comparison of length-based selectivity patterns for each fleet and survey for Gulf of Mexico Scamp in the terminal year of the assessment, 2017. The SEDAR 68 AP Base Model had 3 highly uncertain parameters ($CV > 1$) whereas only the descending limb of the Recreational Headboat curve remains uncertain in the SEDAR 68 RW Base Model.

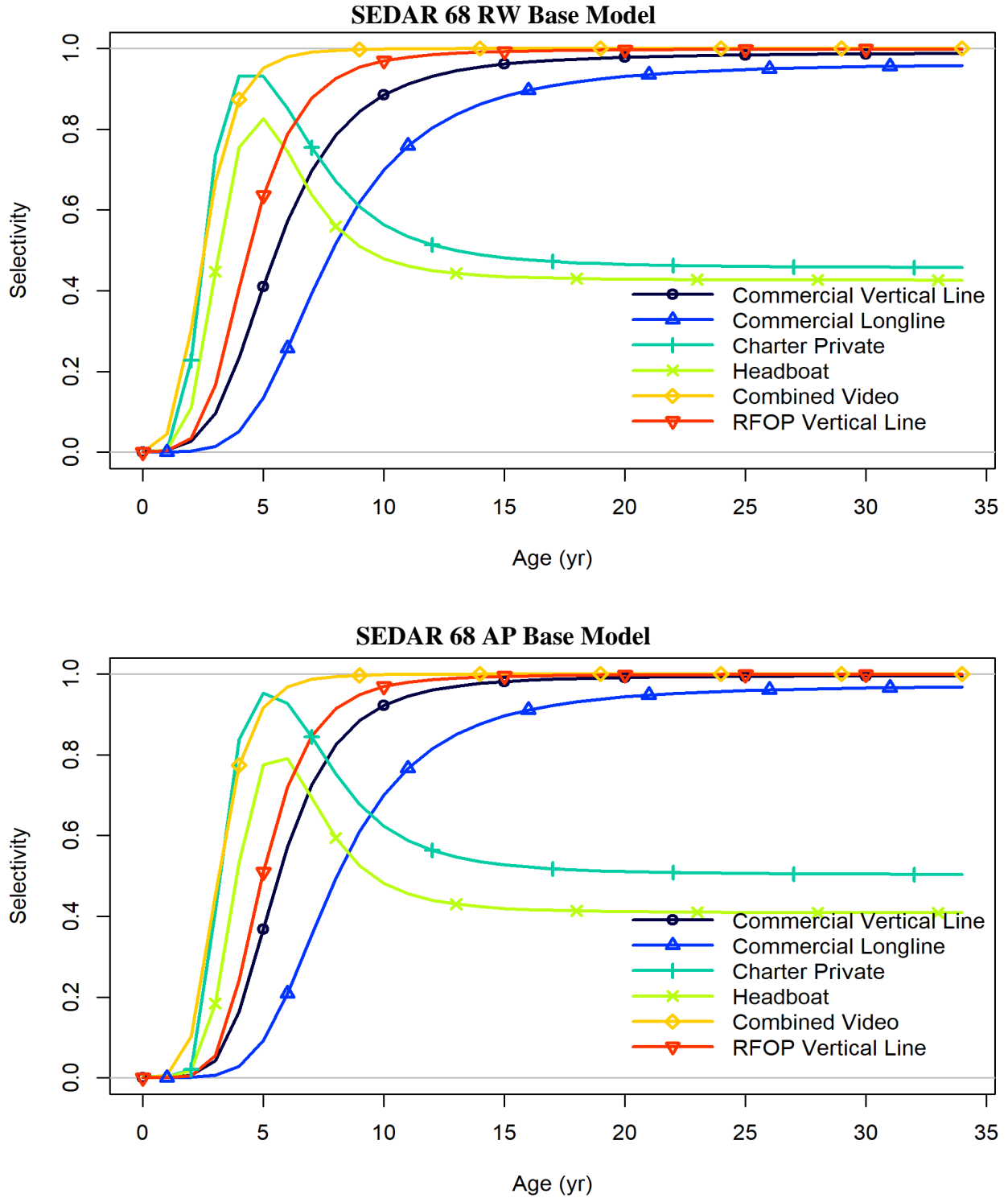

Figure 17. Derived age-based selectivity for each fleet and survey for Gulf of Mexico Scamp in the terminal year of the assessment, 2017.

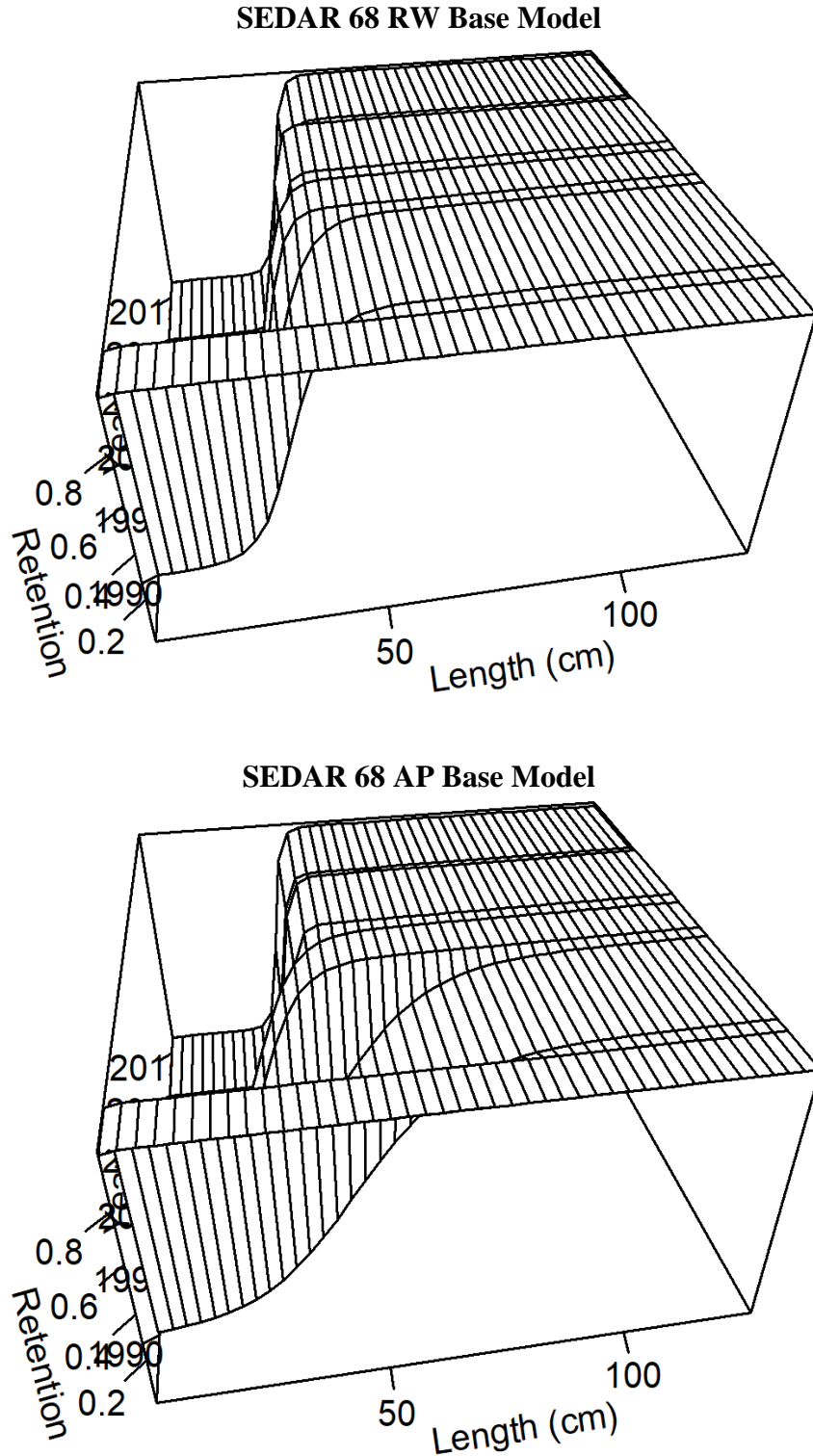

Figure 18. Comparison of time-varying retention at length for the Commercial Vertical Line fleet for Gulf of Mexico Scamp. The SEDAR 68 AP Base Model fixed the inflection points at size limits for all blocks except 1999-2002 whereas the SEDAR 68 RW Base Model estimated the inflection points for all blocks.

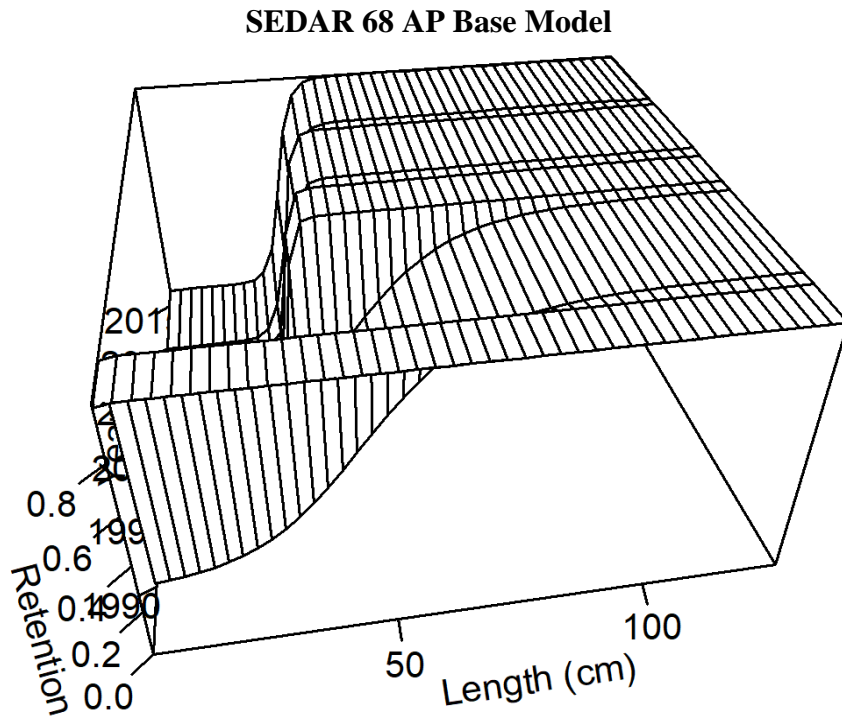
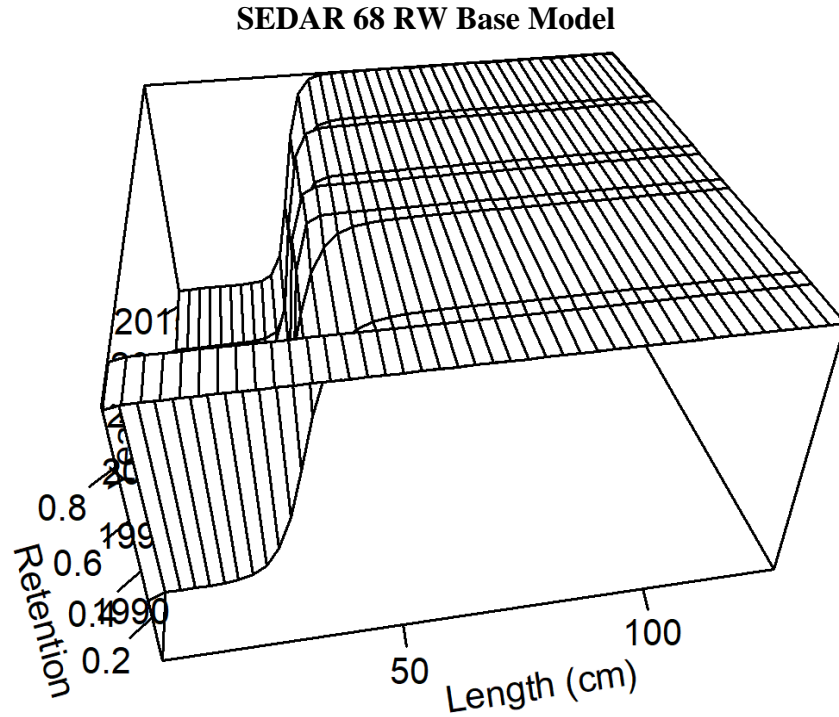

Figure 19. Comparison of time-varying retention at length for the Commercial Longline fleet for Gulf of Mexico Scamp. The SEDAR 68 AP Base Model fixed the inflection points at size limits for all blocks except 1999-2002 whereas the SEDAR 68 RW Base Model estimated the inflection points for all blocks.

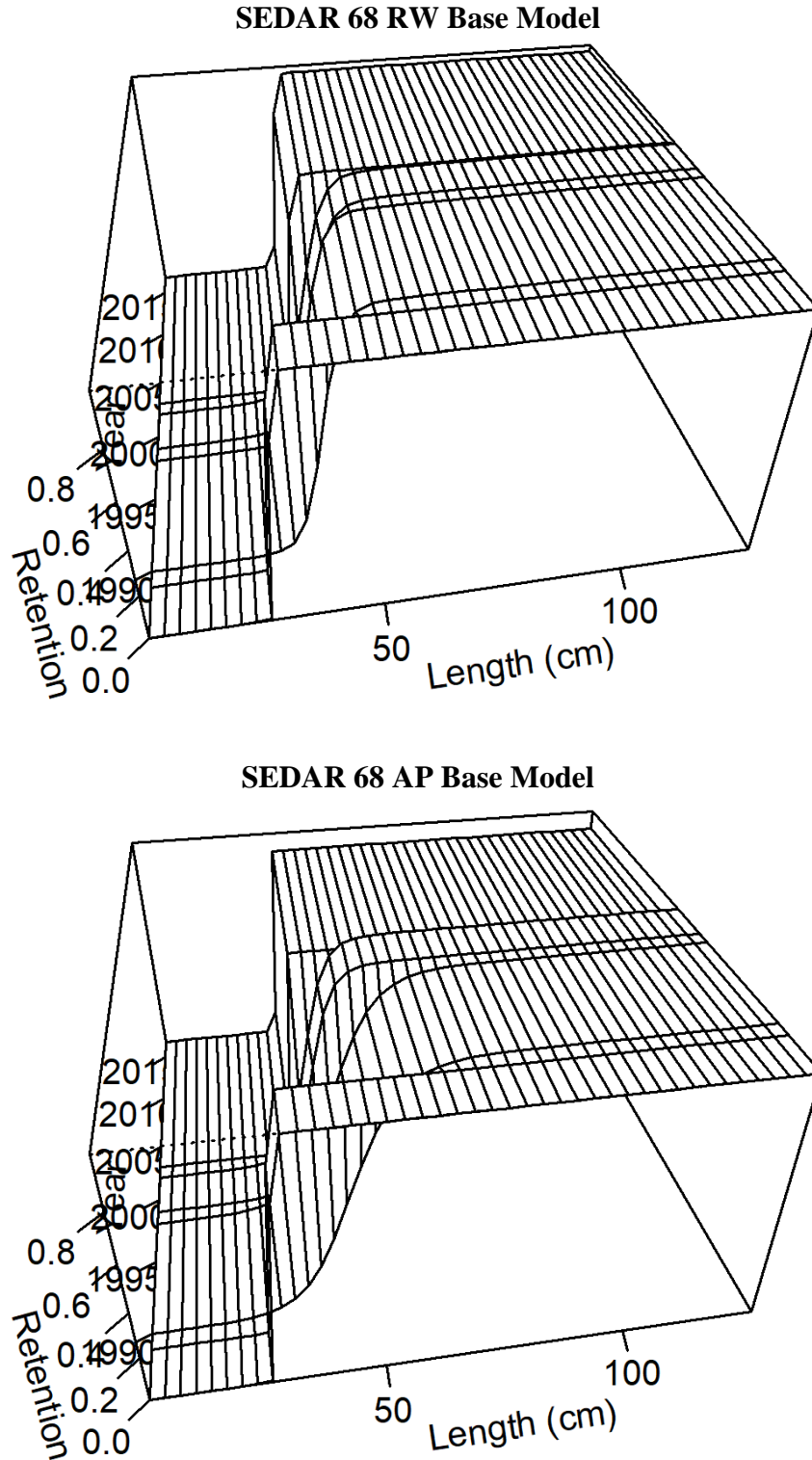

Figure 20. Comparison of time-varying retention at length for the Recreational Charter Private fleet for Gulf of Mexico Scamp. The SEDAR 68 AP Base Model fixed the inflection points at size limits for all blocks except 1999-2002 whereas the SEDAR 68 RW Base Model estimated the inflection points for all blocks. Note that in both models, the parameter controlling the asymptote of the retention curves in 1990-1998 and 1999-2002 exhibited a CV above 1.

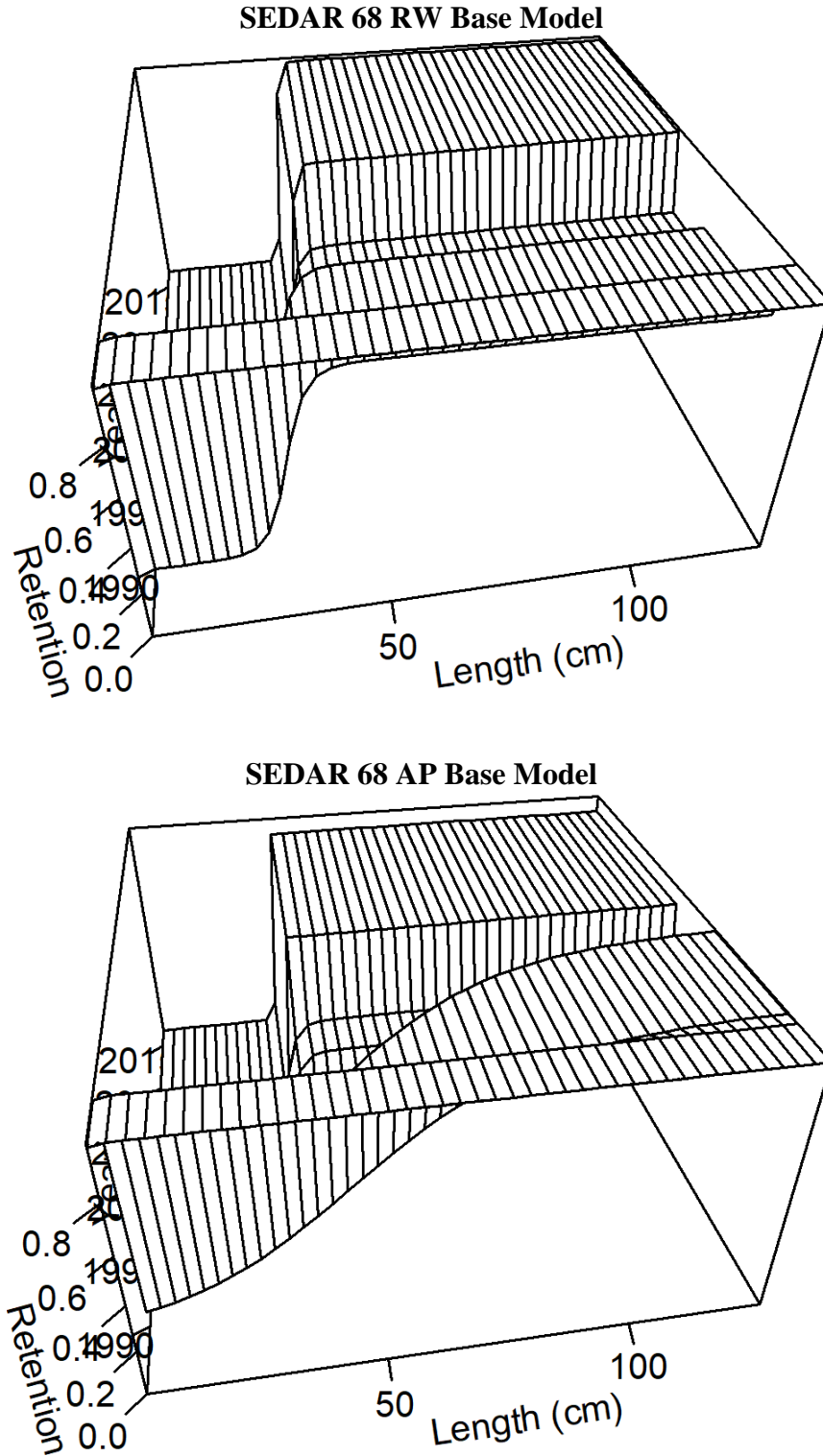

Figure 21. Comparison of time-varying retention at length for the Recreational Headboat fleet for Gulf of Mexico Scamp. The SEDAR 68 AP Base Model fixed the inflection points at size limits for all blocks except 1999-2002 whereas the SEDAR 68 RW Base Model estimated the inflection points for all blocks. Note that the parameter controlling the width of the 1990-1998 retention curve bounded at the upper bound in the SEDAR 68 AP Base Model.

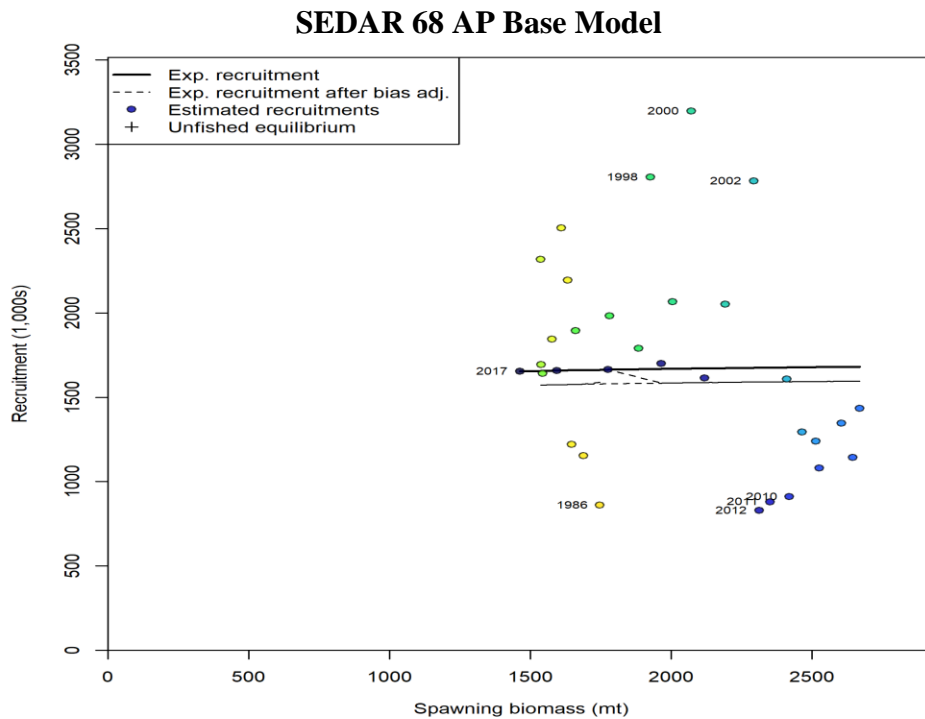
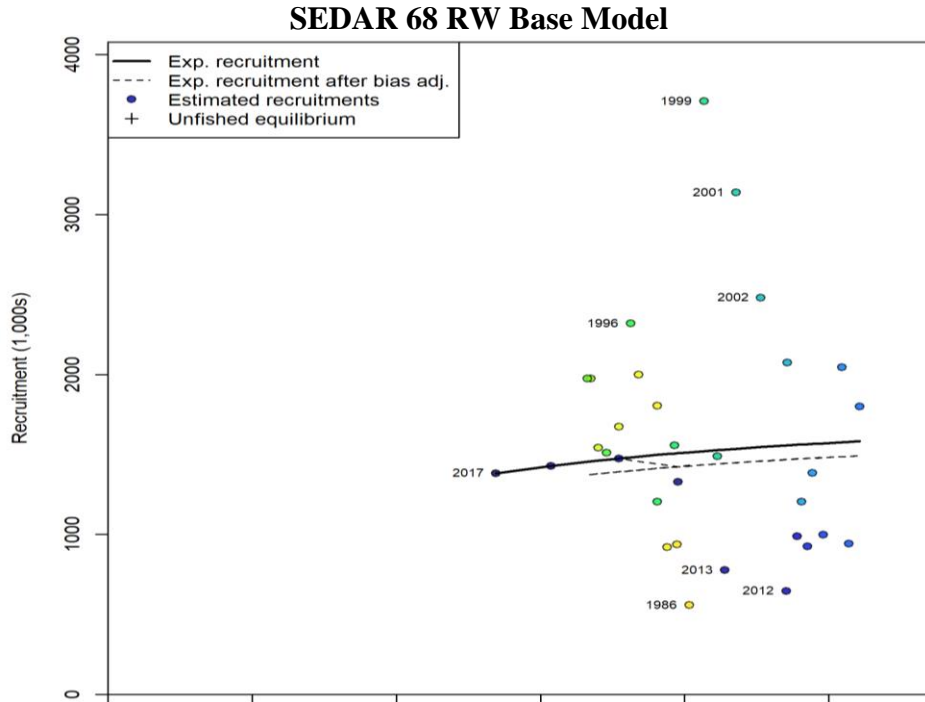

Figure 22. Comparison of the expected stock-recruitment relationship for Gulf of Mexico Scamp. Steepness was fixed at 0.6935 and σ_R was estimated at 0.445 (0.128) in the SEDAR 68 RW Base Model whereas both parameters were estimated in the SEDAR 68 AP Base Model. Plotted are expected annual recruitments from SS (circles), expected recruitment from the stock-recruit relationship (black line), and bias adjusted recruitment from the stock-recruit relationship (dashed line).

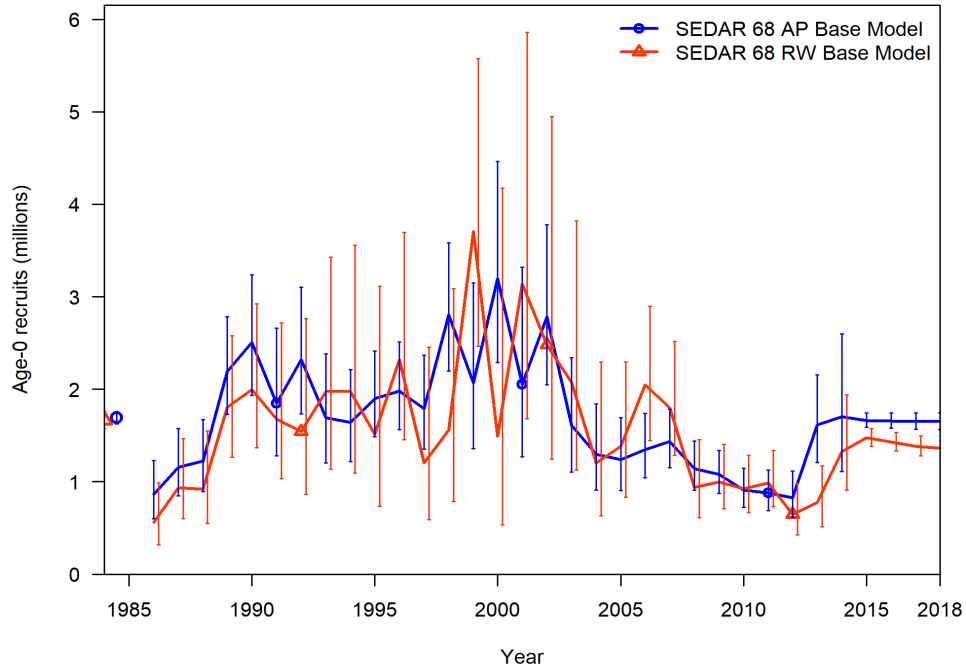

Figure 23. Estimated Age-0 recruitment with ~95% asymptotic intervals (vertical lines) for Gulf of Mexico Scamp. Steepness was fixed at 0.6935 and σ_R was estimated at 0.445 (0.128) in the SEDAR 68 RW Base Model whereas both parameters were estimated in the SEDAR 68 AP Base Model.

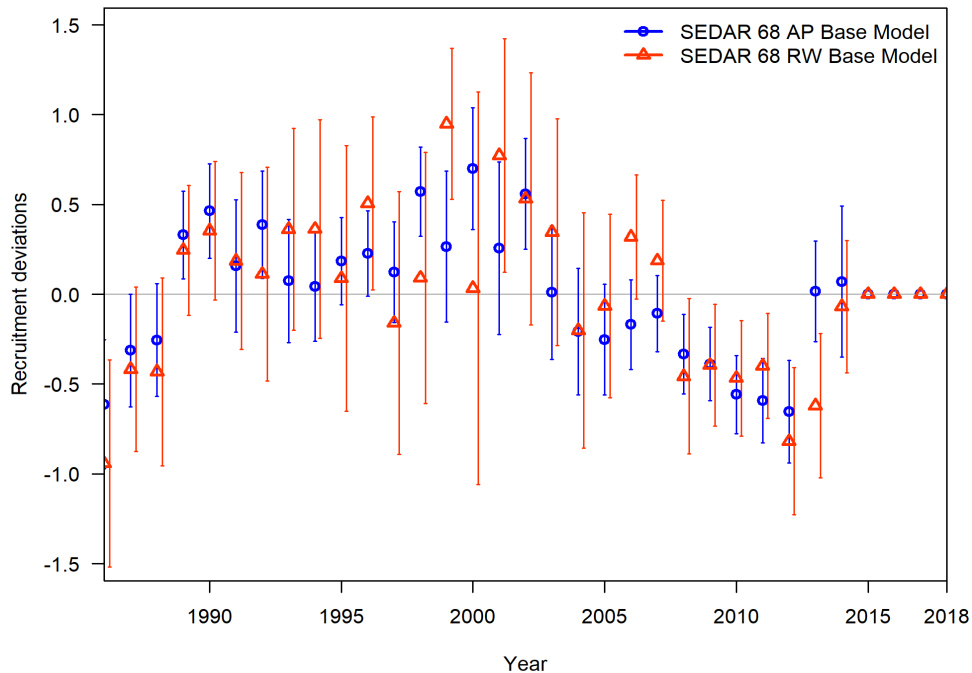

Figure 24. Estimated log-scale recruitment deviations with 95% confidence intervals (vertical lines) for Gulf of Mexico Scamp. Steepness was fixed at 0.6935 and σ_R was estimated at 0.445 (0.128) in the SEDAR 68 RW Base Model whereas both parameters were estimated in the SEDAR 68 AP Base Model.

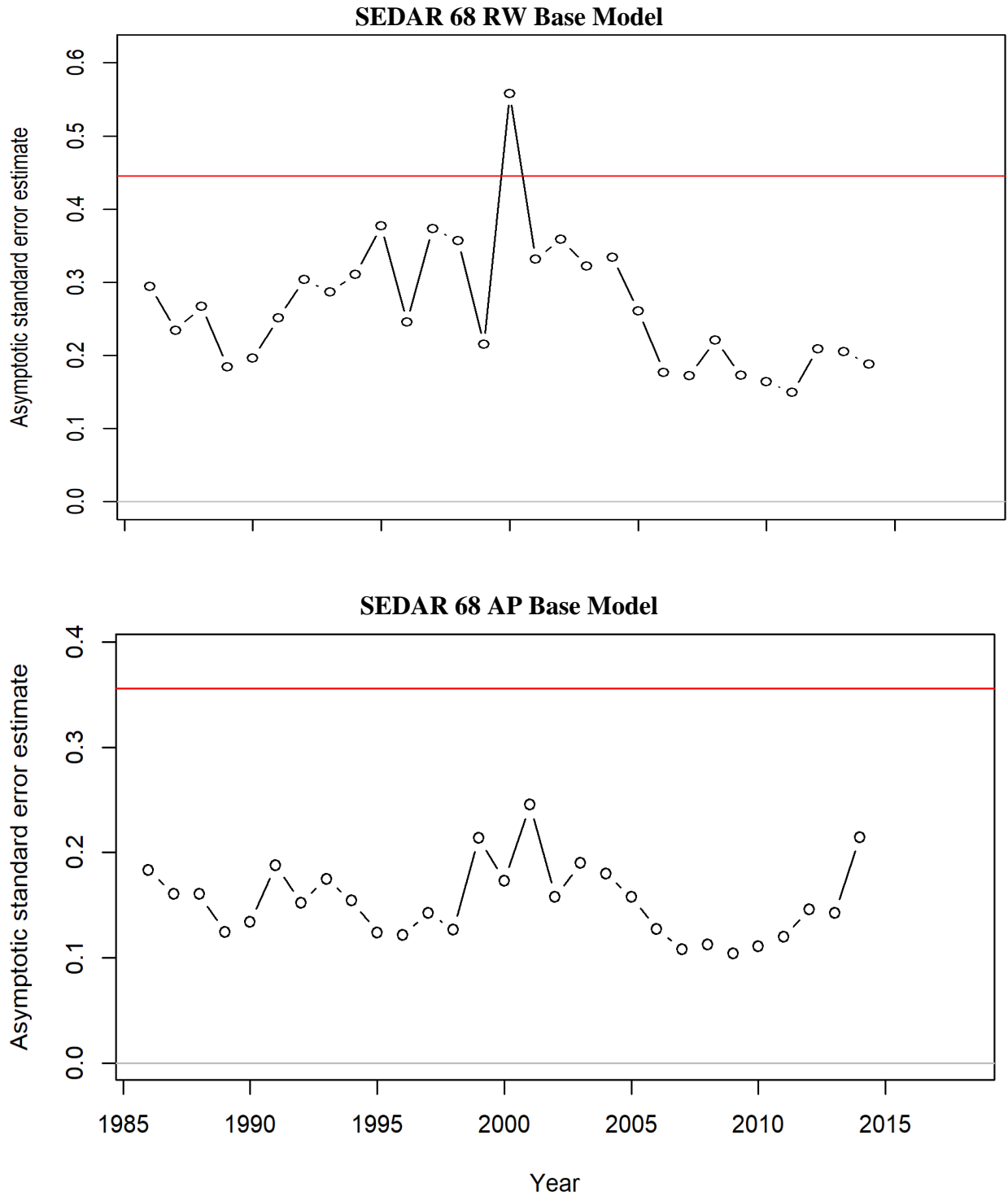

Figure 25. Asymptotic standard errors for recruitment deviations for Gulf of Mexico Scamp. Steepness was fixed at 0.6935 and σ_R was estimated at 0.445 (0.128) in the SEDAR 68 RW Base Model whereas both parameters were estimated in the SEDAR 68 AP Base Model.

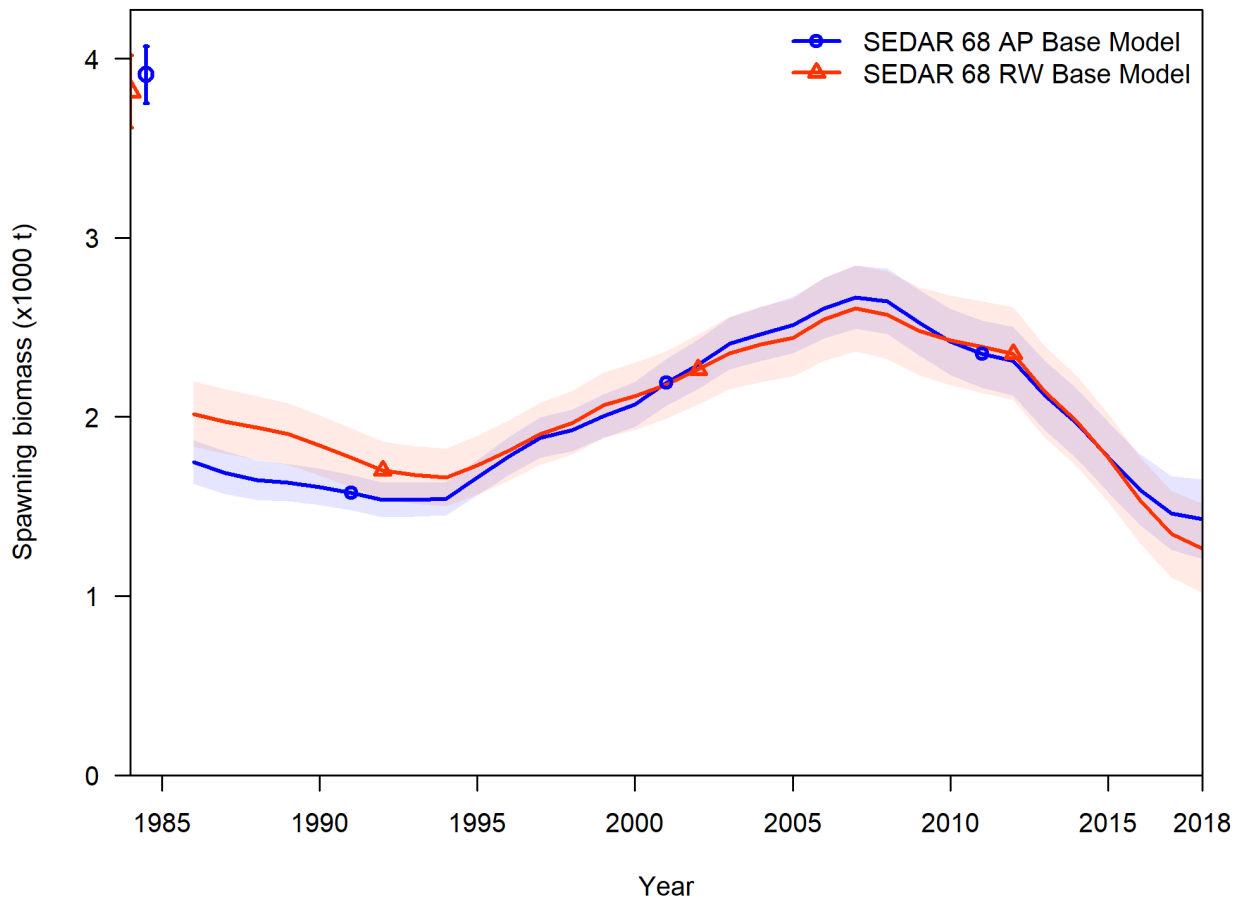

Figure 26. Estimates of spawning stock biomass (metric tons) with ~95% asymptotic intervals (shaded region) for Gulf of Mexico Scamp.

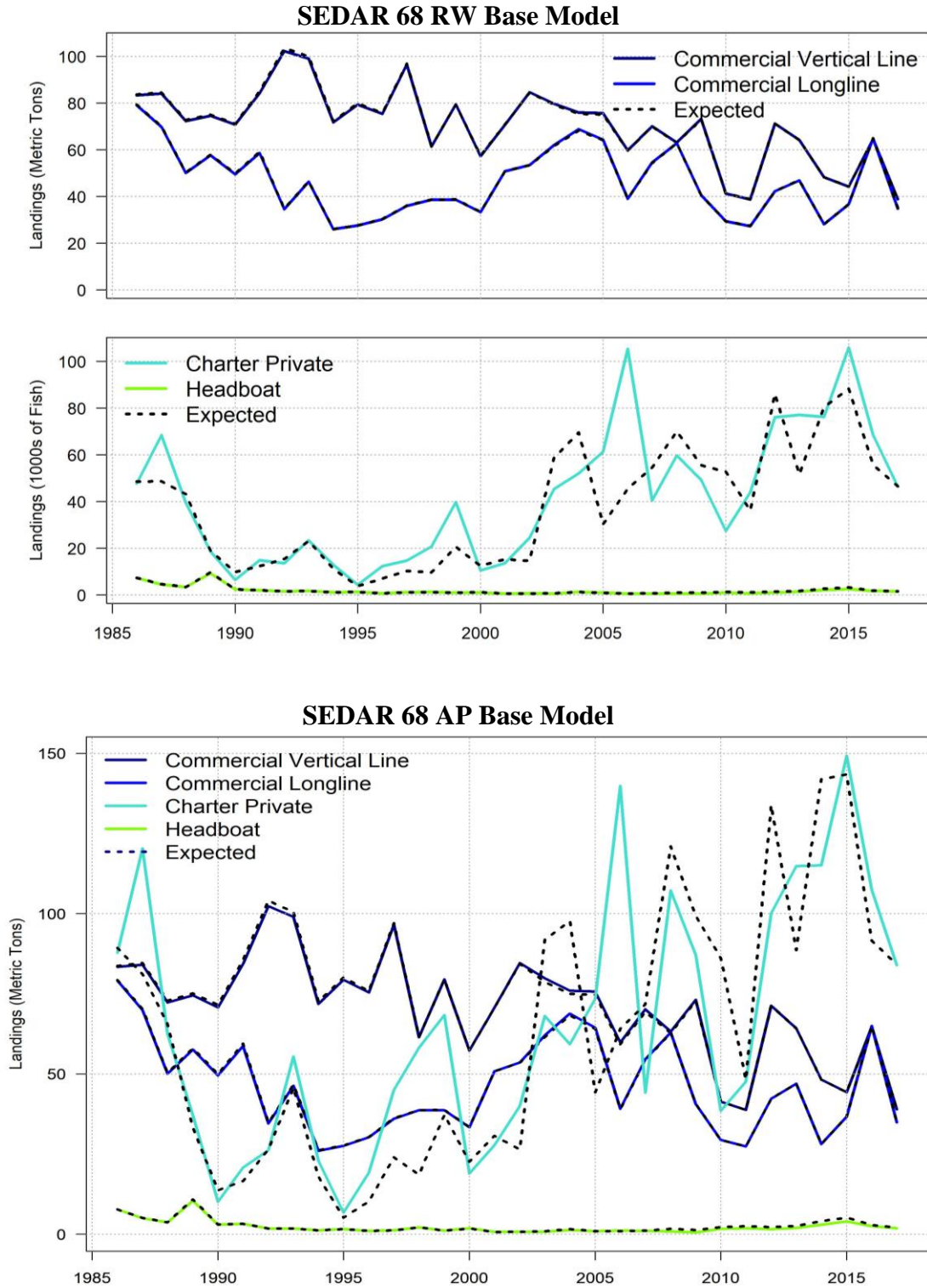

Figure 27. Comparison of Gulf of Mexico Scamp input (thick colored lines) and expected (dashed lines) landings by fleet. Commercial landings are shown in thousands of pounds but input into the SEDAR 68 RW Base Model in units of metric tons. Recreational landings are shown and input in numbers (1,000s of fish) for the SEDAR 68 RW Base Model. Note that the SEDAR 68 AP Base Model input all landings data in units of metric tons.

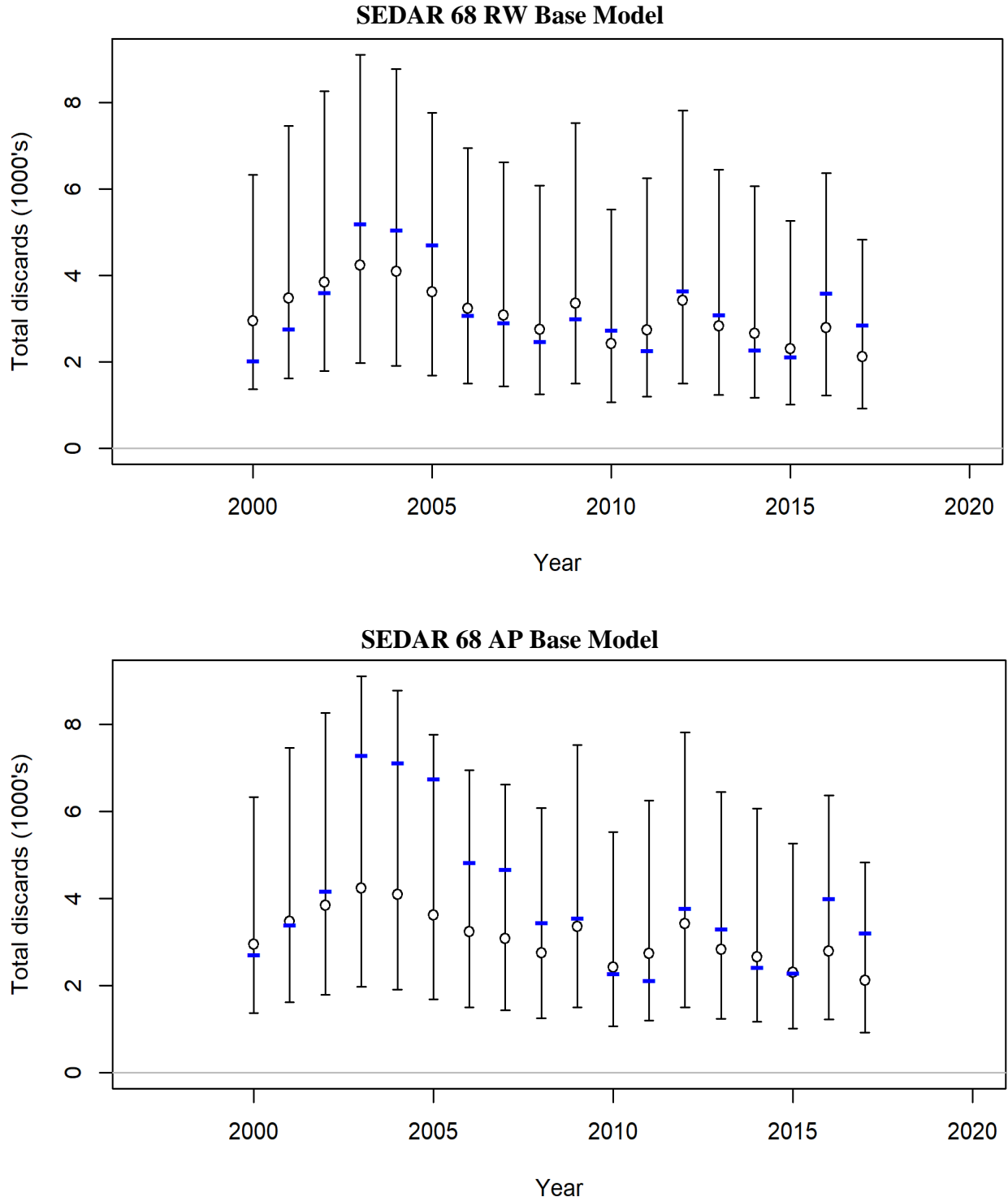

Figure 28. Comparison of input (dots with 95% confidence intervals) and expected (blue lines) Gulf of Mexico Scamp discards by the Commercial Vertical Line fleet. Discards are in numbers of fish (1,000s) and reflect released fish (i.e., before discard mortality has been applied).

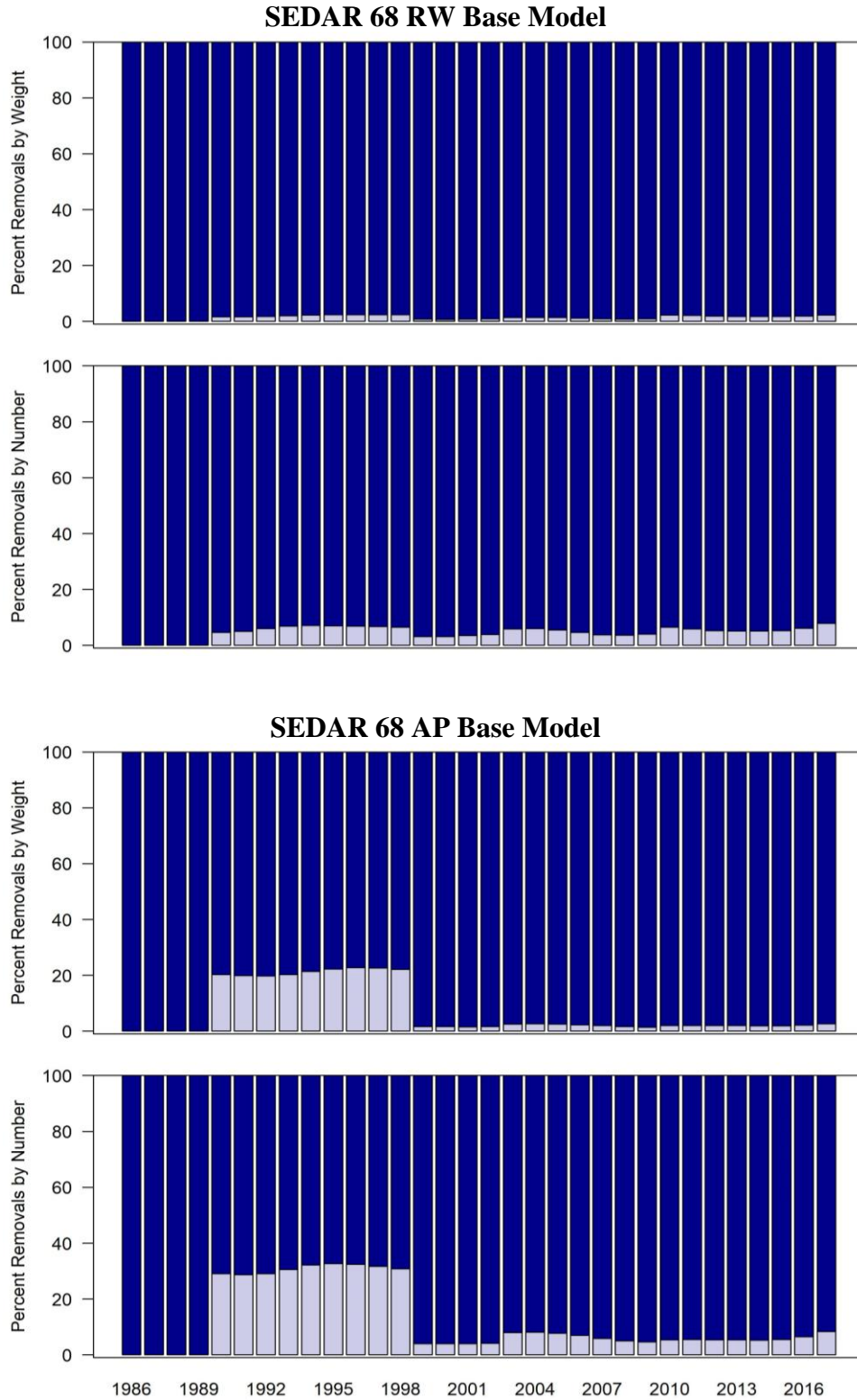

Figure 29. Comparison of landings (dark bars) and dead discards (light bars) for weights (top panels) and numbers of Gulf of Mexico Scamp (bottom panels) for the Commercial Vertical Line fleet.

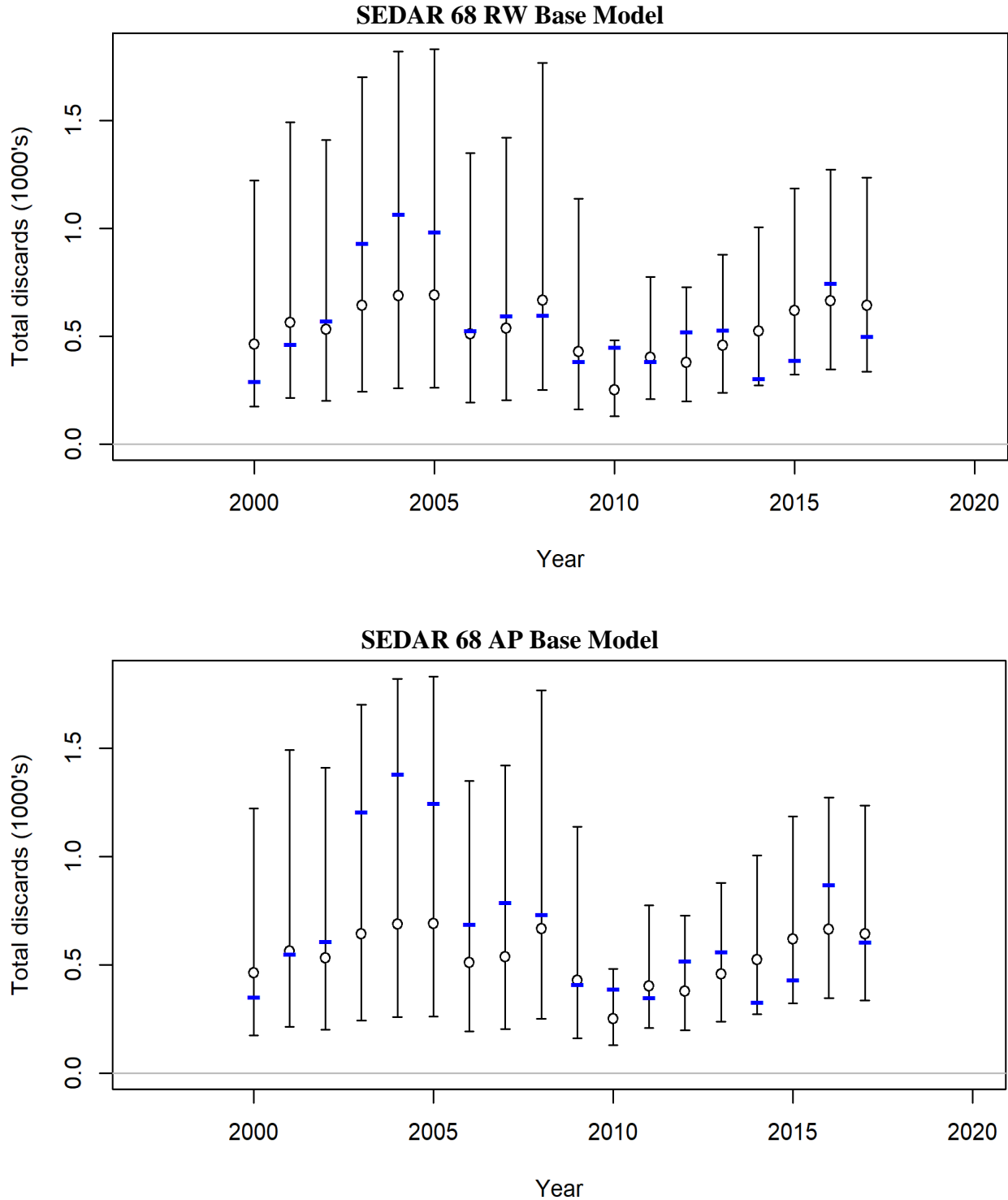

Figure 30. Comparison of input (dots with 95% confidence intervals) and expected (blue lines) Gulf of Mexico Scamp discards by the Commercial Longline fleet. Discards are in numbers of fish (1,000s) and reflect released fish (i.e., before discard mortality has been applied).

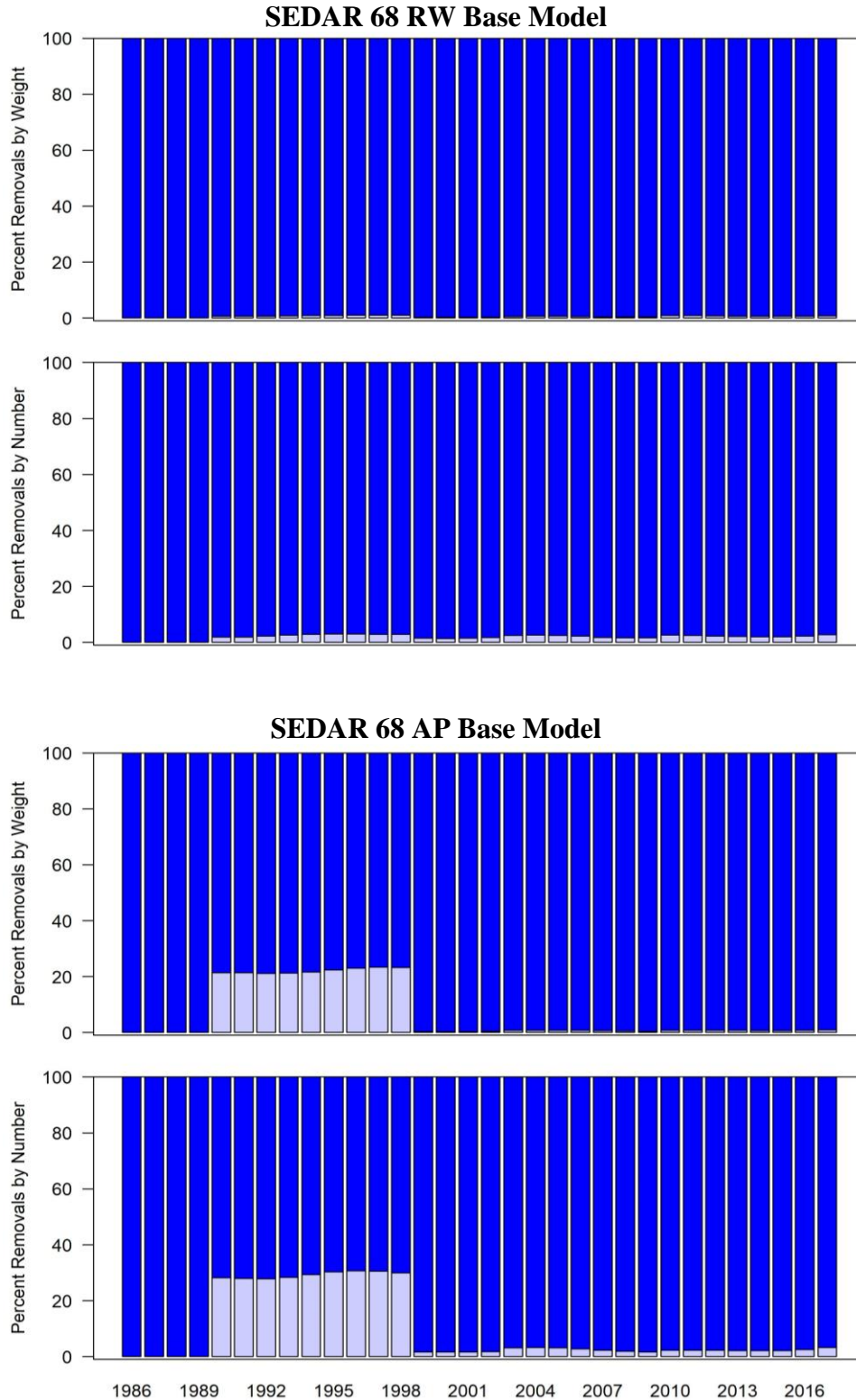

Figure 31. Comparison of landings (dark bars) and dead discards (light bars) for weights (top panels) and numbers of Gulf of Mexico Scamp (bottom panels) for the Commercial Longline fleet.

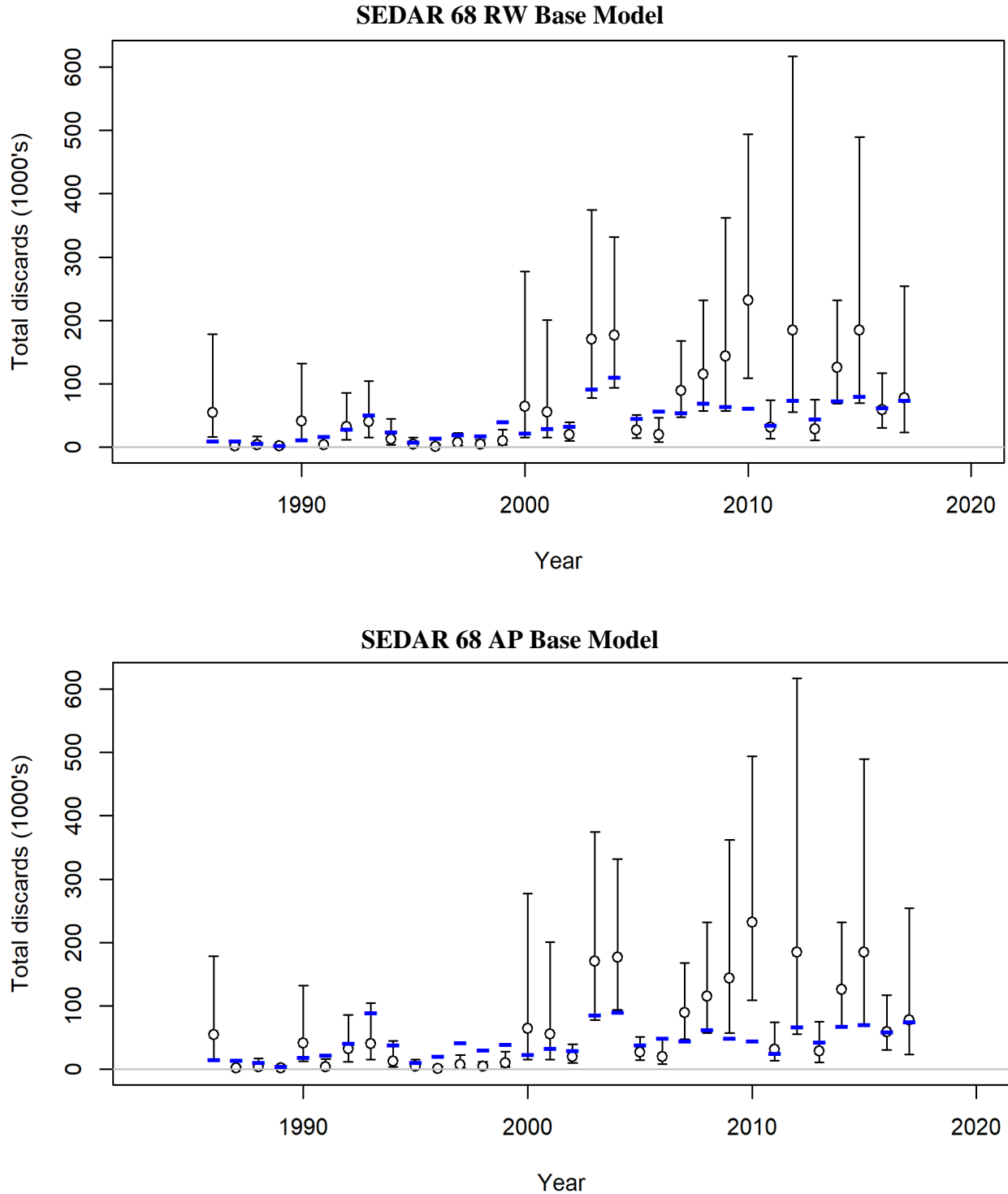

Figure 32. Comparison of input (dots with 95% confidence intervals) and expected (blue lines) Gulf of Mexico Scamp discards by the Recreational Charter Private fleet. Discards are in numbers of fish (1,000s) and reflect released fish (i.e., before discard mortality has been applied).

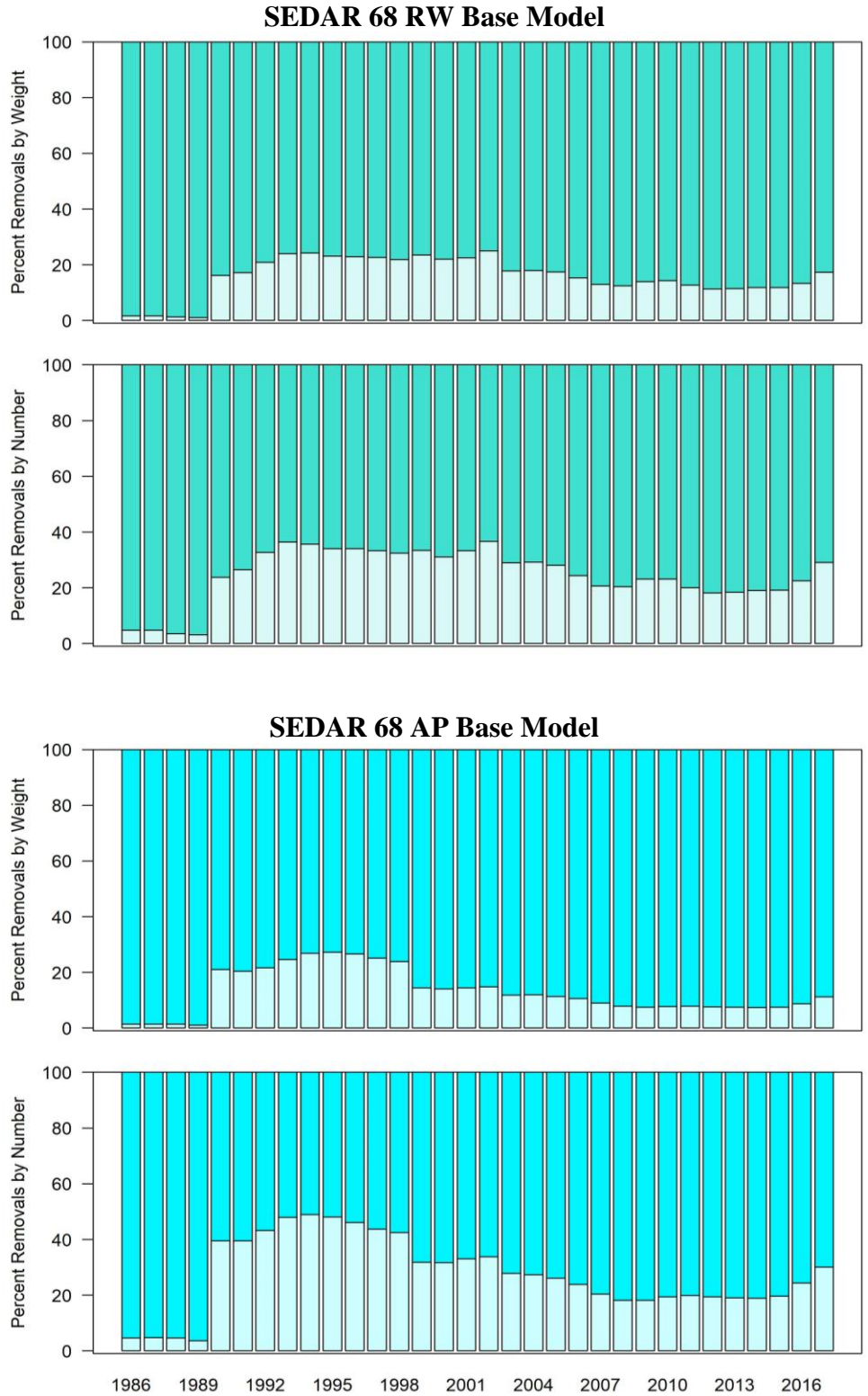

Figure 33. Comparison of landings (dark bars) and dead discards (light bars) for weights (top panels) and numbers of Gulf of Mexico Scamp (bottom panels) for the Recreational Charter Private fleet.

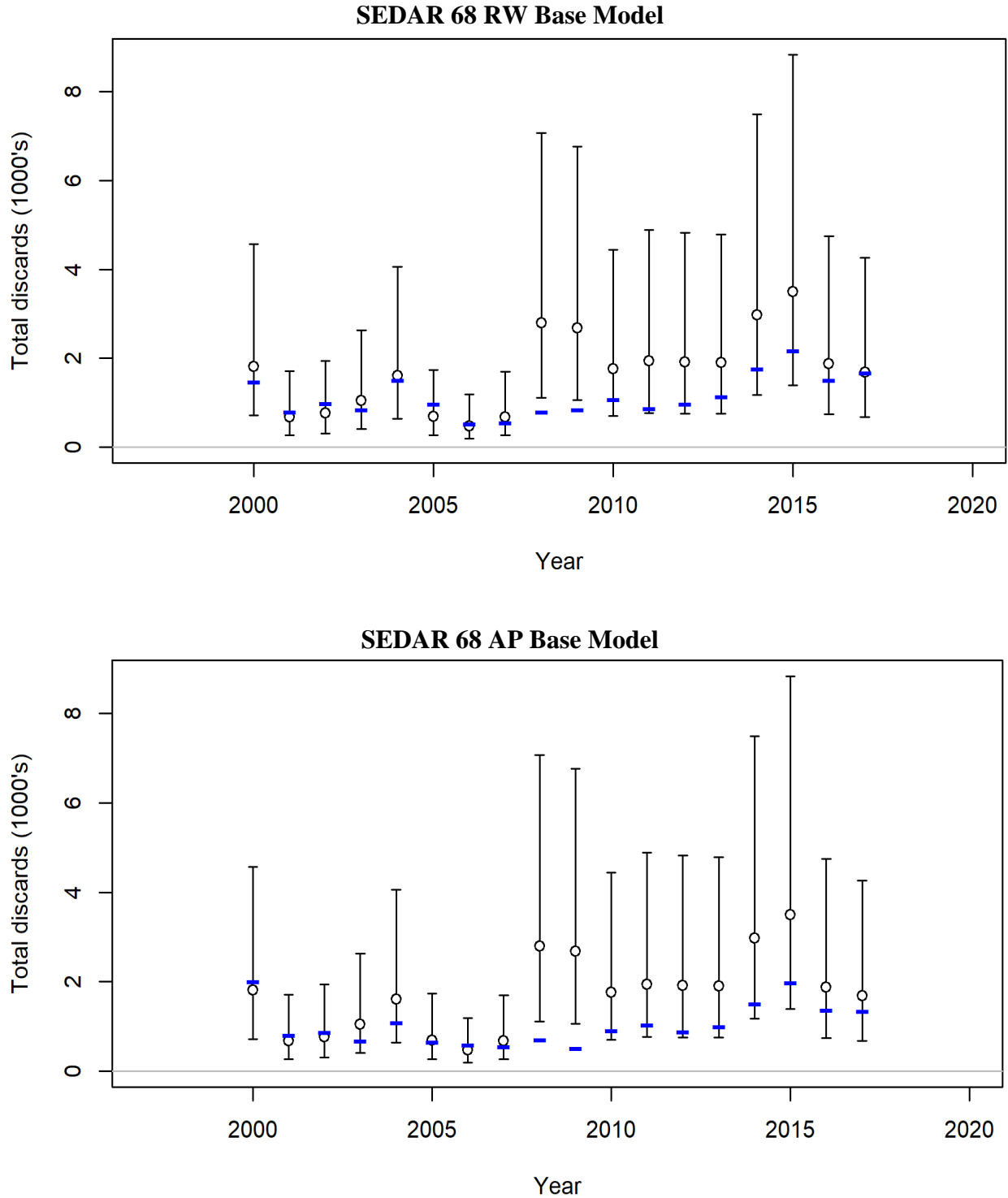

Figure 34. Comparison of input (dots with 95% confidence intervals) and expected (blue lines) Gulf of Mexico Scamp discards by the Recreational Headboat fleet. Discards are in numbers of fish (1,000s) and reflect released fish (i.e., before discard mortality has been applied).

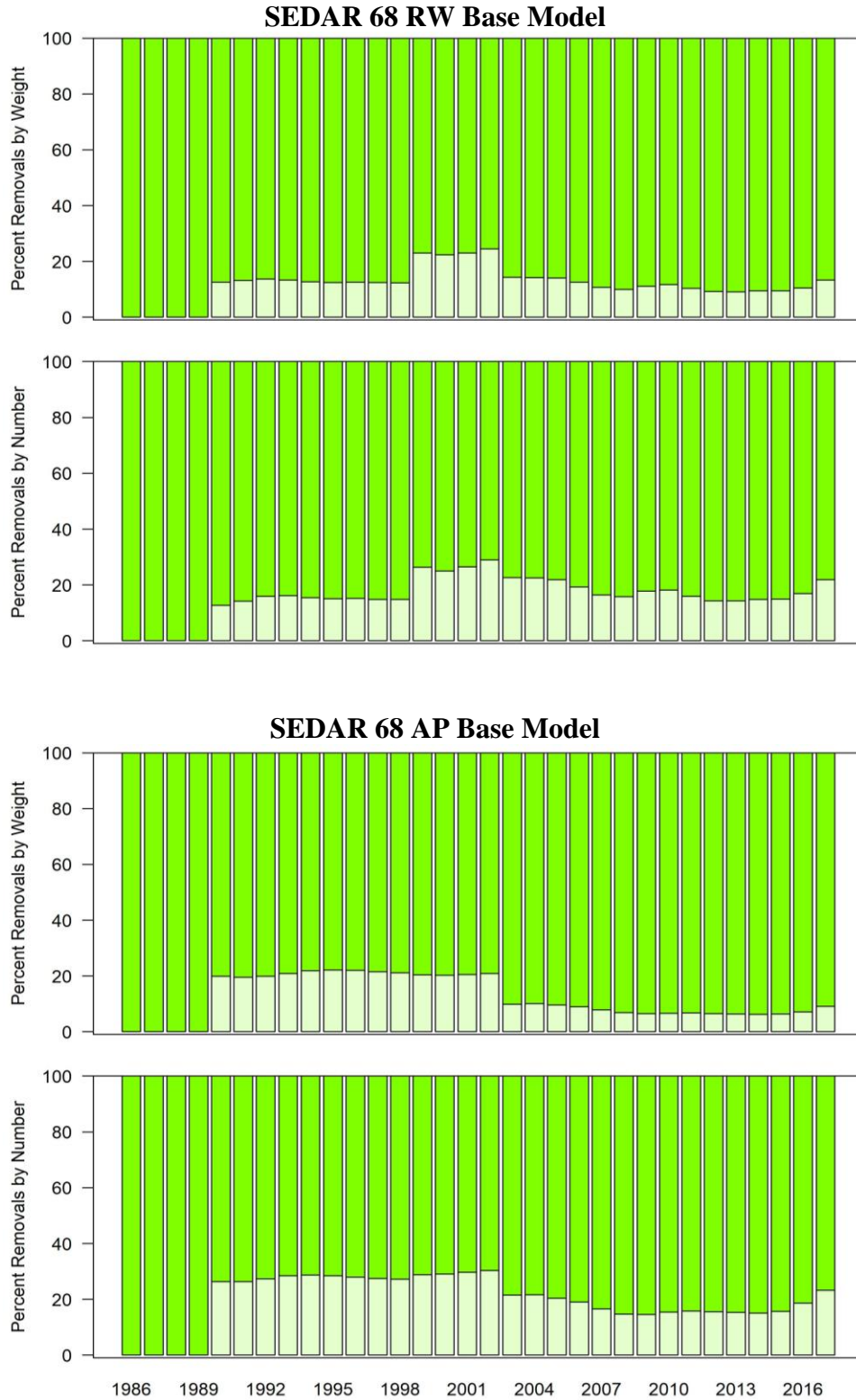

Figure 35. Comparison of landings (dark bars) and dead discards (light bars) for weights (top panels) and numbers of Gulf of Mexico Scamp (bottom panels) for the Recreational Headboat fleet.

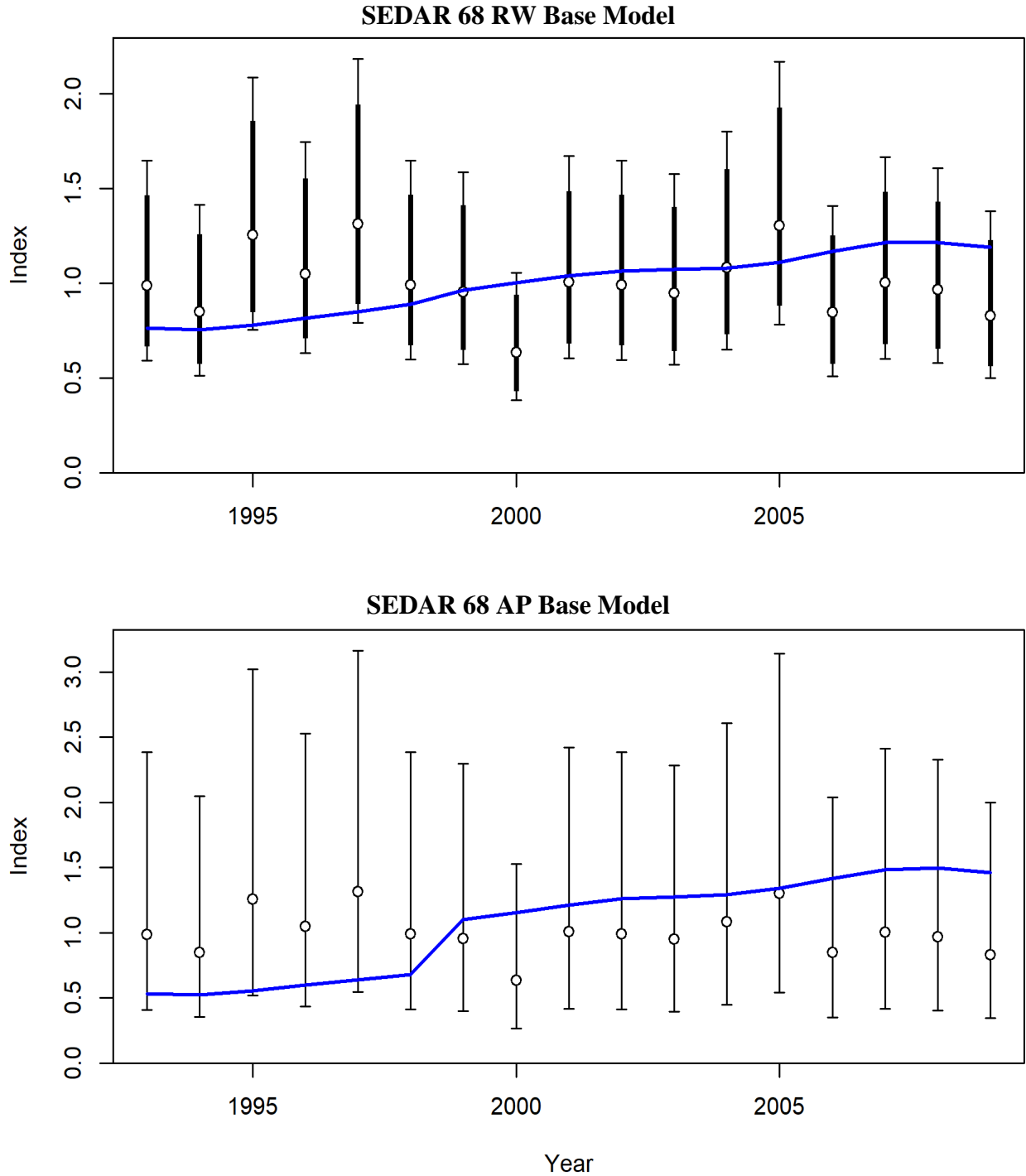

Figure 36. Comparison of input (dots with 95% confidence intervals) and expected (blue lines) indices of relative abundance for Gulf of Mexico Scamp retained by the Commercial Vertical Line fleet prior to the implementation of the Grouper-Tilefish Individual Fishing Quota for the SEDAR 68 RW Base Model (RMSE = 0.26) and the SEDAR 68 AP Base Model (RMSE = 0.472). Thicker lines indicate input uncertainty before the addition of extra uncertainty in the SEDAR 68 RW Base Model (extra SD of 0.06, CV = 0.776). A variance adjustment of 0.249 was added to the input SE for each year in the SEDAR 68 AP Base Model.

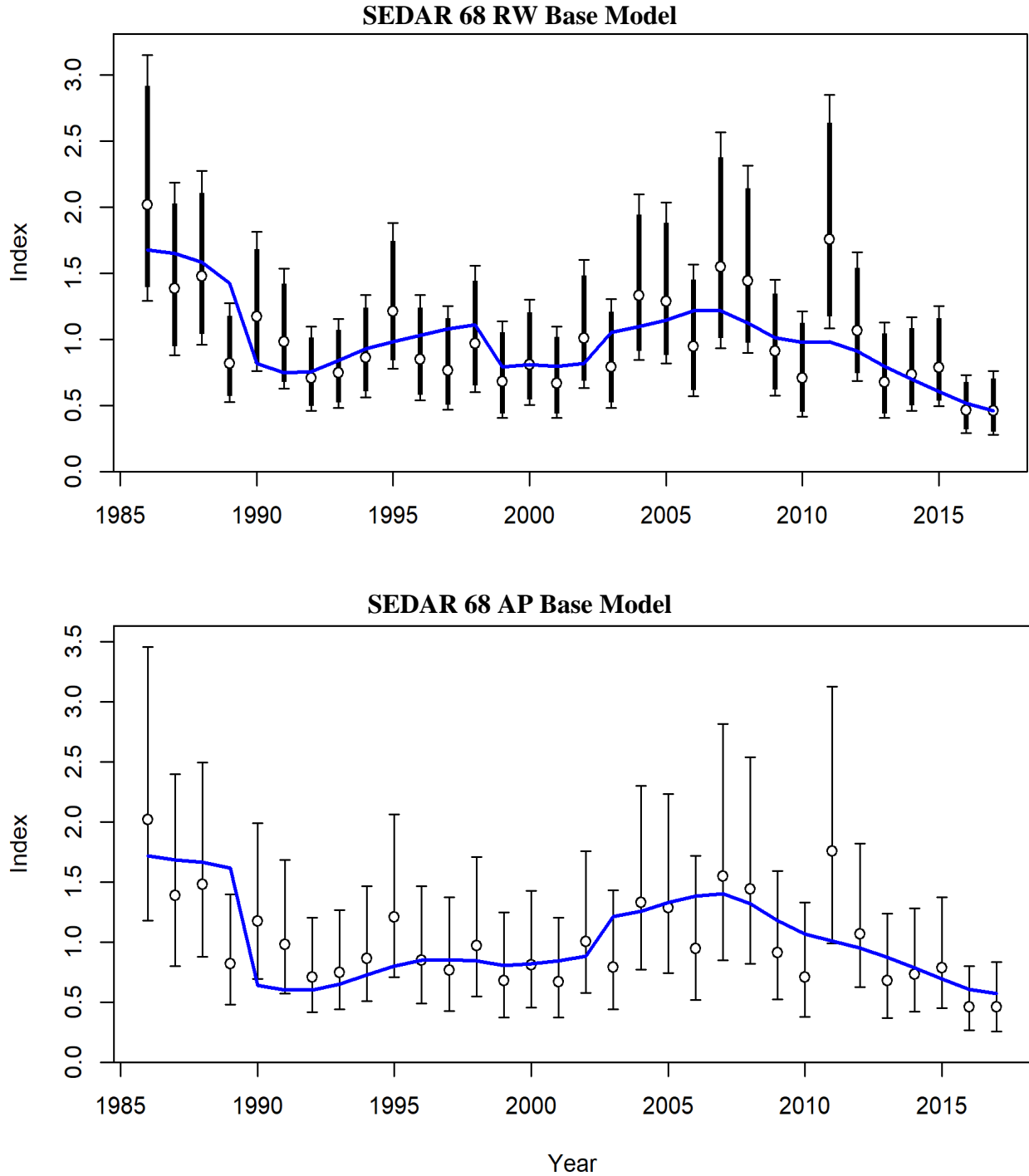

Figure 37. Comparison of input (dots with 95% confidence intervals) and expected (blue lines) indices of relative abundance for Gulf of Mexico Scamp retained by the Recreational Headboat fleet for the SEDAR 68 RW Base Model (RMSE = 0.239) and the SEDAR 68 AP Base Model (RMSE = 0.287). Thicker lines indicate input uncertainty before the addition of extra uncertainty in the SEDAR 68 RW Base Model (extra SD of 0.039, CV = 0.77). A variance adjustment of 0.087 was added to the input SE for each year in the SEDAR 68 AP Base Model.

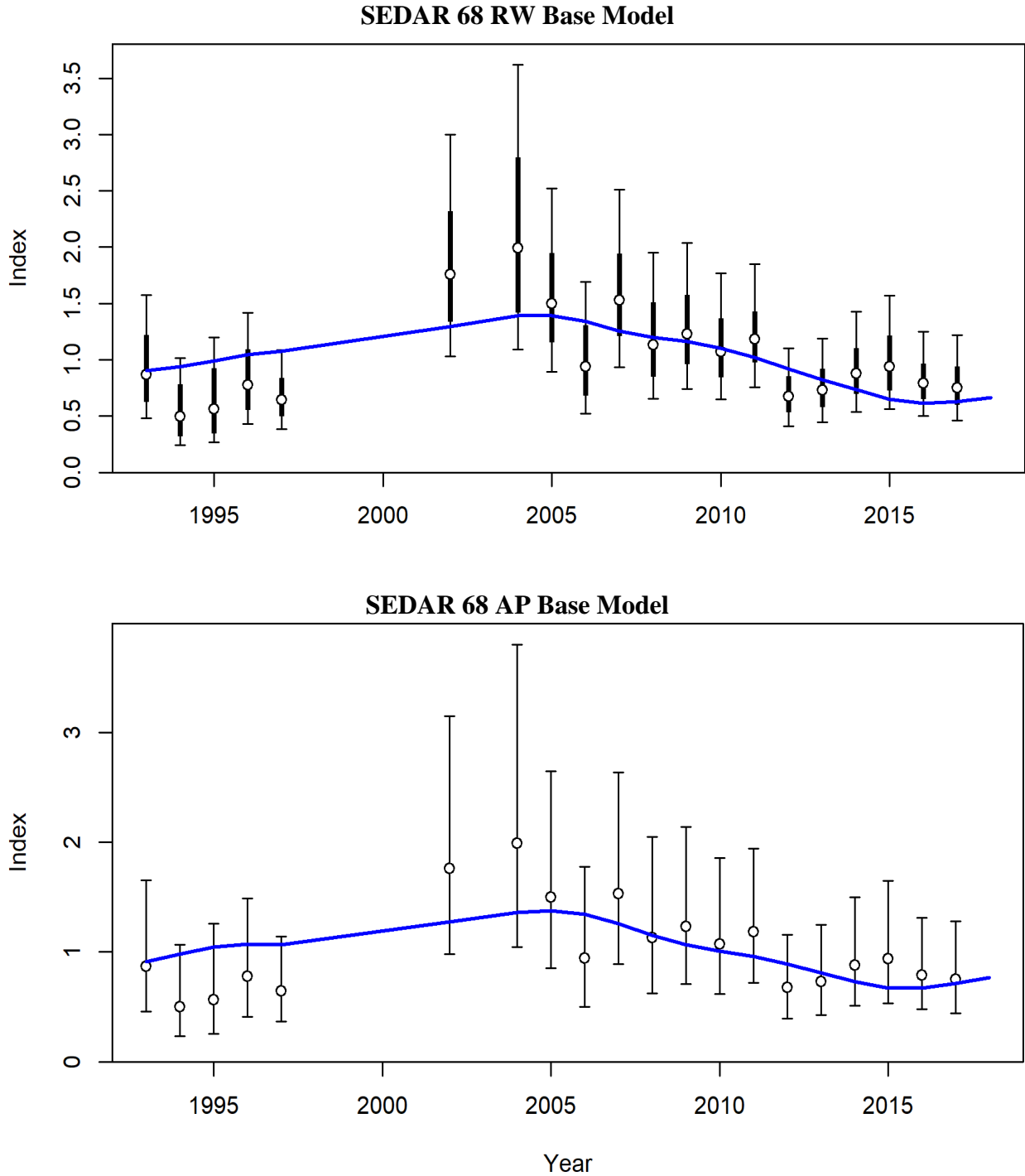

Figure 38. Input (dots with 95% confidence intervals) and expected (blue lines) indices of relative abundance for Gulf of Mexico Scamp from the Combined Video Survey for the SEDAR 68 RW Base Model (RMSE = 0.305) and the SEDAR 68 AP Base Model (RMSE = 0.311). Thicker lines indicate input uncertainty before the addition of the extra uncertainty in the SEDAR 68 RW Base Model (extra SD of 0.132, CV = 0.353). A variance adjustment of 0.156 was added to the input SE for each year in the SEDAR 68 AP Base Model.

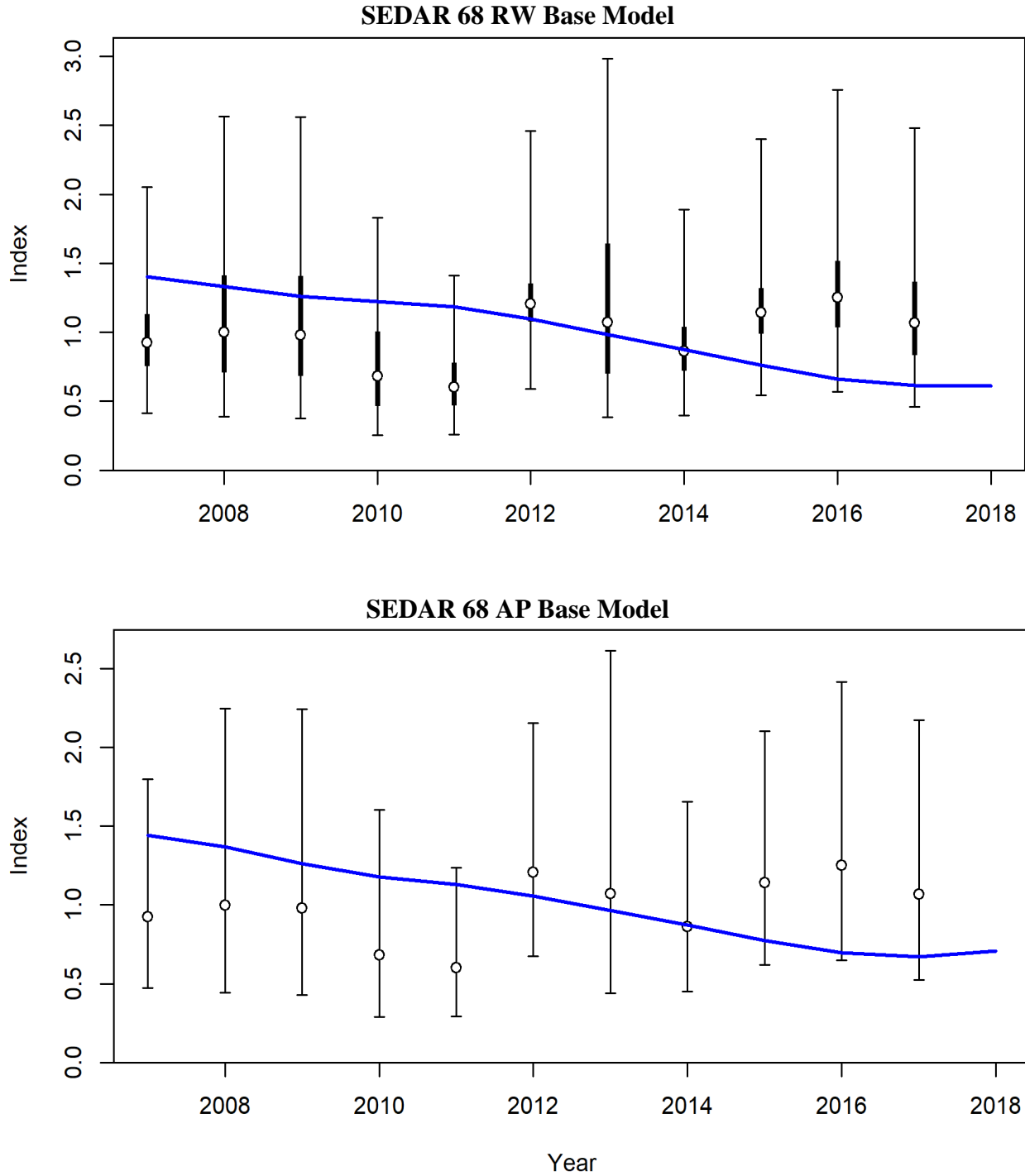

Figure 39. Input (dots with 95% confidence intervals) and expected (blue lines) indices of relative abundance for Gulf of Mexico Scamp from the RFOP Vertical Line Survey for the SEDAR 68 RW Base Model (RMSE = 0.428) and the SEDAR 68 AP Base Model (RMSE = 0.404). Thicker lines indicate input uncertainty before the addition of the extra uncertainty in the SEDAR 68 RW Base Model (extra SD of 0.305, CV = 0.307). A variance adjustment of 0.238 was added to the input SE for each year in the SEDAR 68 AP Base Model.

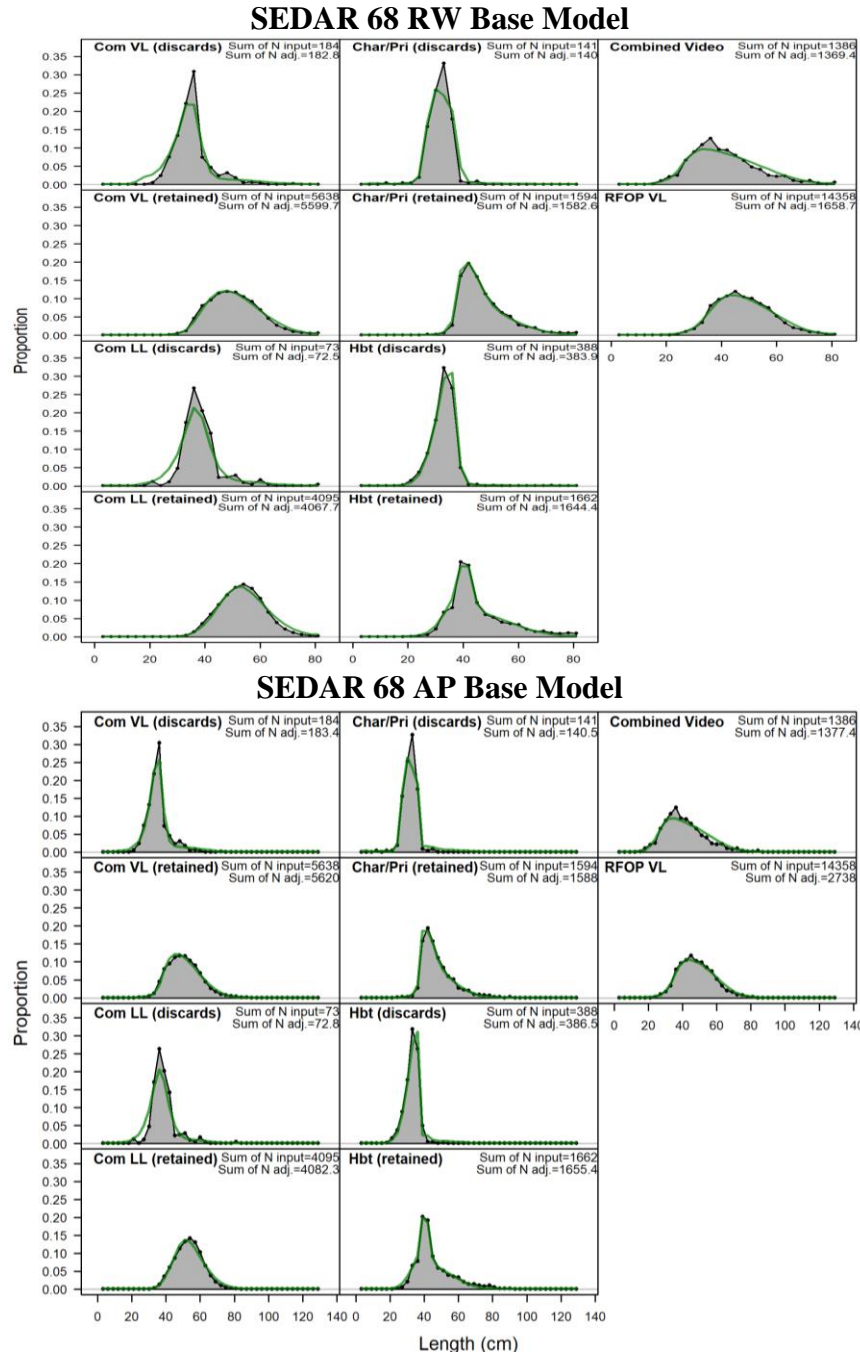

Figure 40. Comparison of model fits to the length compositions of discarded or landed (i.e., retained) Scamp aggregated across years within a given fleet or survey in the Gulf of Mexico. Green lines represent expected length compositions, while grey shaded regions represent observed length compositions. The input (N_{input}) and adjusted (N_{adj}) sample sizes are provided in the upper right corner of each panel. Abbreviations include: Commercial Vertical Line (Com VL), Commercial Longline (Com LL), Recreational Charter Private (Char/Pri), Recreational Headboat (Hbt), and the Reef Fish Observer Program Vertical Line Survey (RFOP VL).

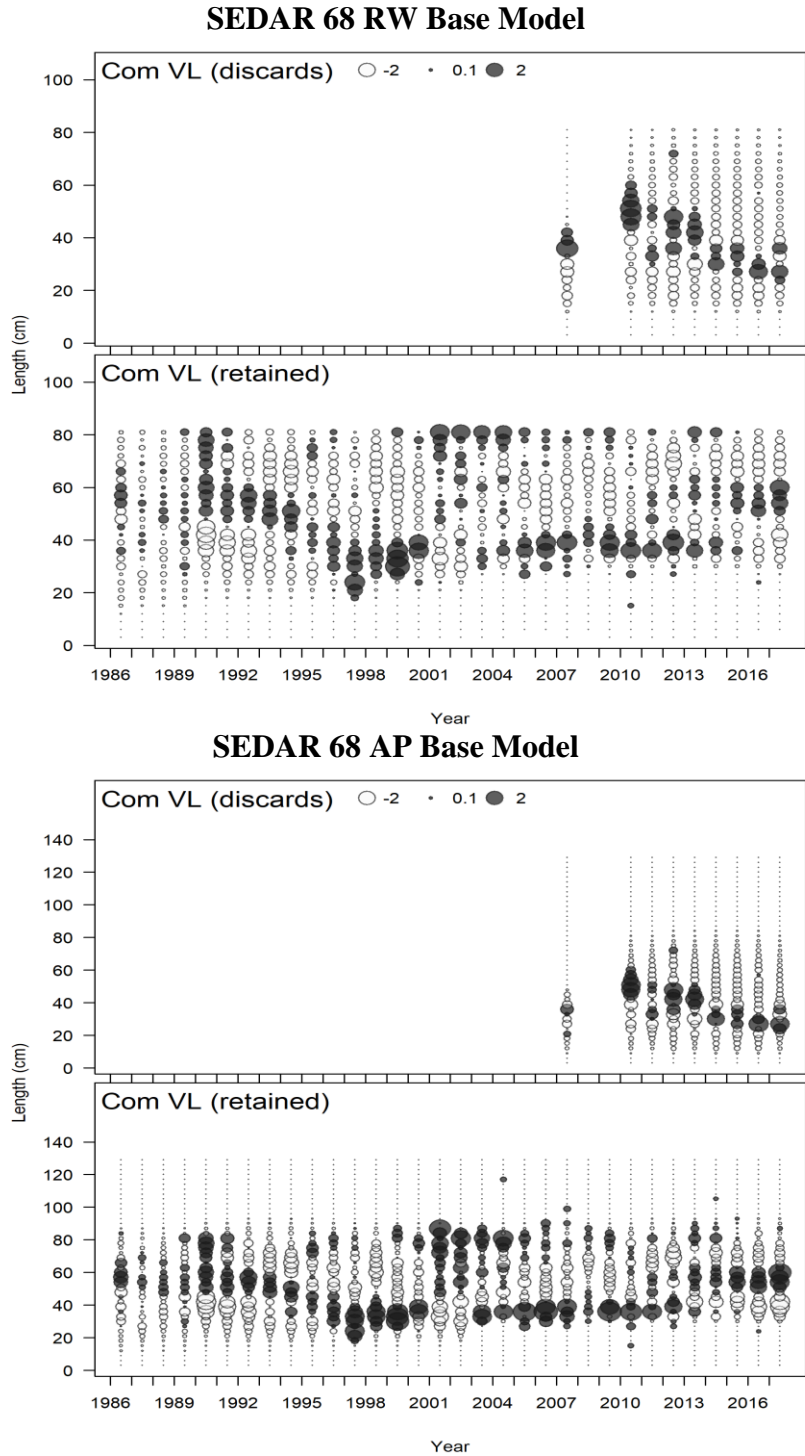

Figure 41. Pearson residuals for the length compositions of discarded or landed (i.e., retained) Scamp for the Commercial Vertical Line fleet in the Gulf of Mexico. Closed bubbles are positive residuals ($Obs > Exp$) and open bubbles are negative residuals ($Obs < Exp$). Range of residuals for the SEDAR 68 RW Base Model are -1.57 to 3.14 and -2.66 to 3.98 for discarded and retained lengths, respectively. Range of residuals for the SEDAR 68 AP Base Model are -1.51 to 2.6 and -2.69 to 3.83 for discarded and retained lengths, respectively.

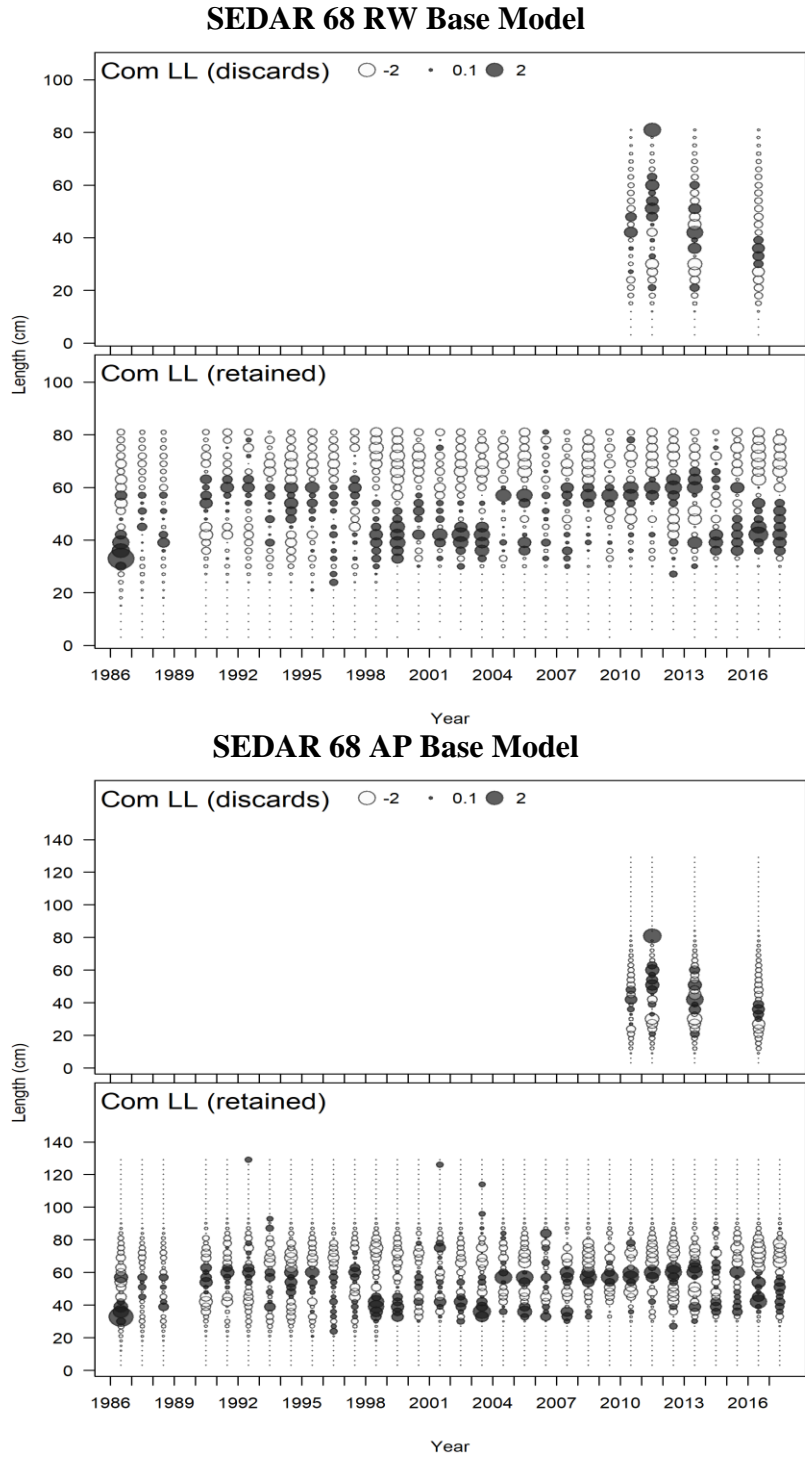

Figure 41 Continued. Pearson residuals for the length compositions of discarded or landed (i.e., retained) Scamp for the Commercial Longline fleet in the Gulf of Mexico. Closed bubbles are positive residuals ($Obs > Exp$) and open bubbles are negative residuals ($Obs < Exp$). Range of residuals for the SEDAR 68 RW Base Model are -1.43 to 2.04 and -1.55 to 4.52 for discarded and retained lengths, respectively. Range of residuals for the SEDAR 68 AP Base Model are -1.49 to 2.19 and -1.51 to 3.93 for discarded and retained lengths, respectively.

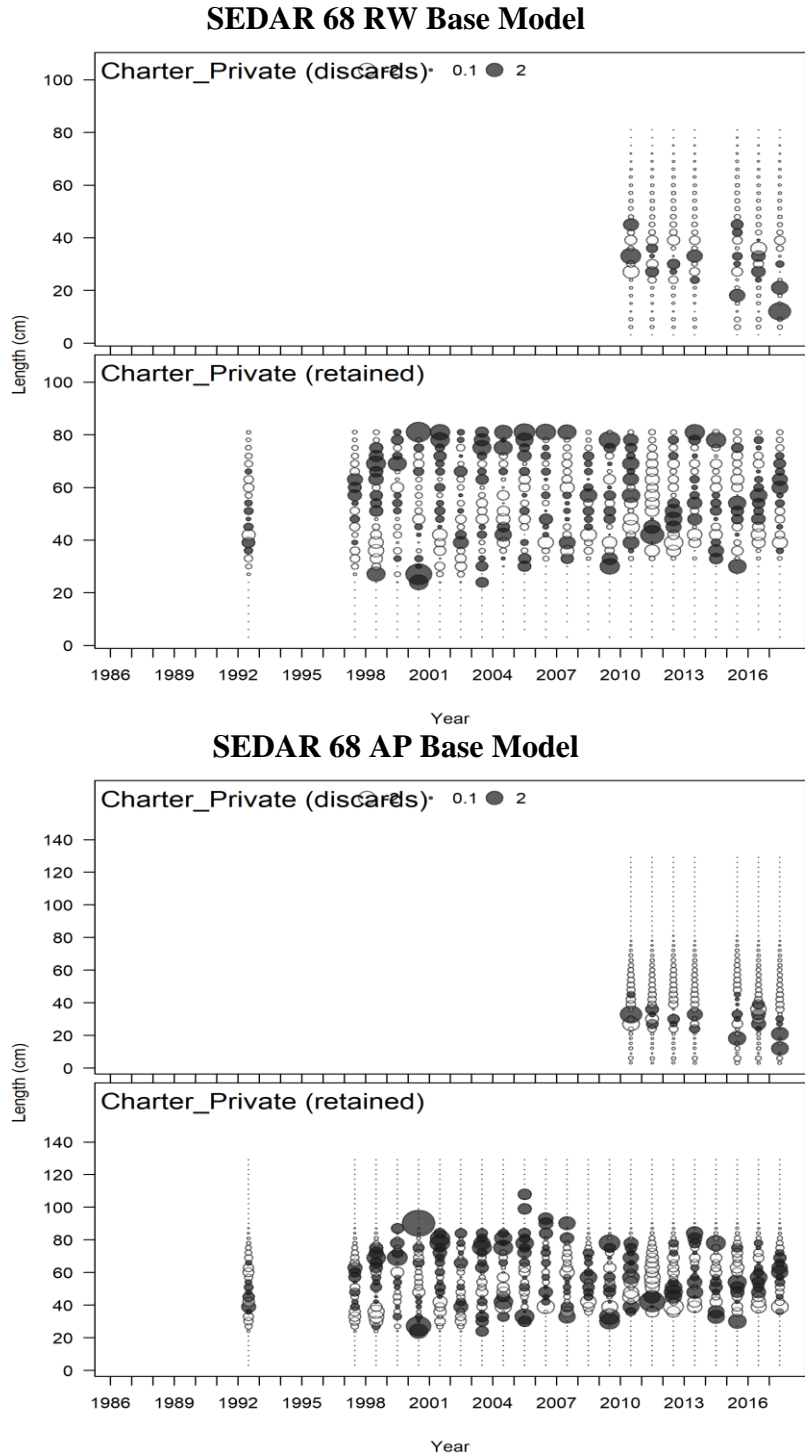

Figure 41 Continued. Pearson residuals for the length compositions of discarded or landed (i.e., retained) Scamp for the Recreational Charter Private fleet in the Gulf of Mexico. Closed bubbles are positive residuals ($Obs > Exp$) and open bubbles are negative residuals ($Obs < Exp$). Range of residuals for the SEDAR 68 RW Base Model are -1.83 to 3.21 and -2.46 to 4.5 for discarded and retained lengths, respectively. Range of residuals for the SEDAR 68 AP Base Model are -1.94 to 3.16 and -2.71 to 7.15 for discarded and retained lengths, respectively.

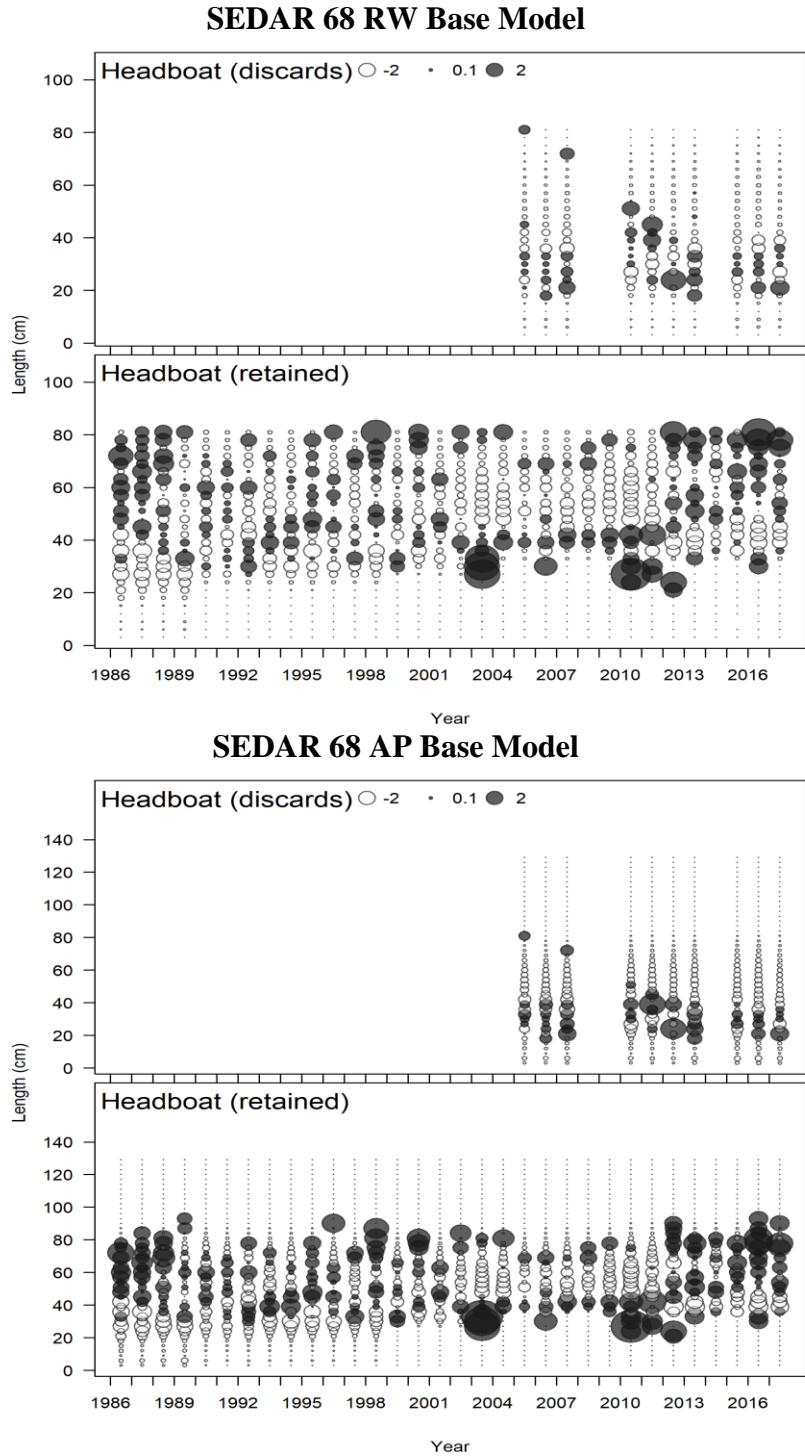

Figure 41 Continued. Pearson residuals for the length compositions of discarded or landed (i.e., retained) Scamp for the Recreational Headboat fleet in the Gulf of Mexico. Closed bubbles are positive residuals ($Obs > Exp$) and open bubbles are negative residuals ($Obs < Exp$). Range of residuals for the SEDAR 68 RW Base Model are -1.47 to 4.31 and -2.41 to 10.75 for discarded and retained lengths, respectively. Range of residuals for the SEDAR 68 AP Base Model are -1.69 to 4.53 and -2.62 to 11.32 for discarded and retained lengths, respectively.

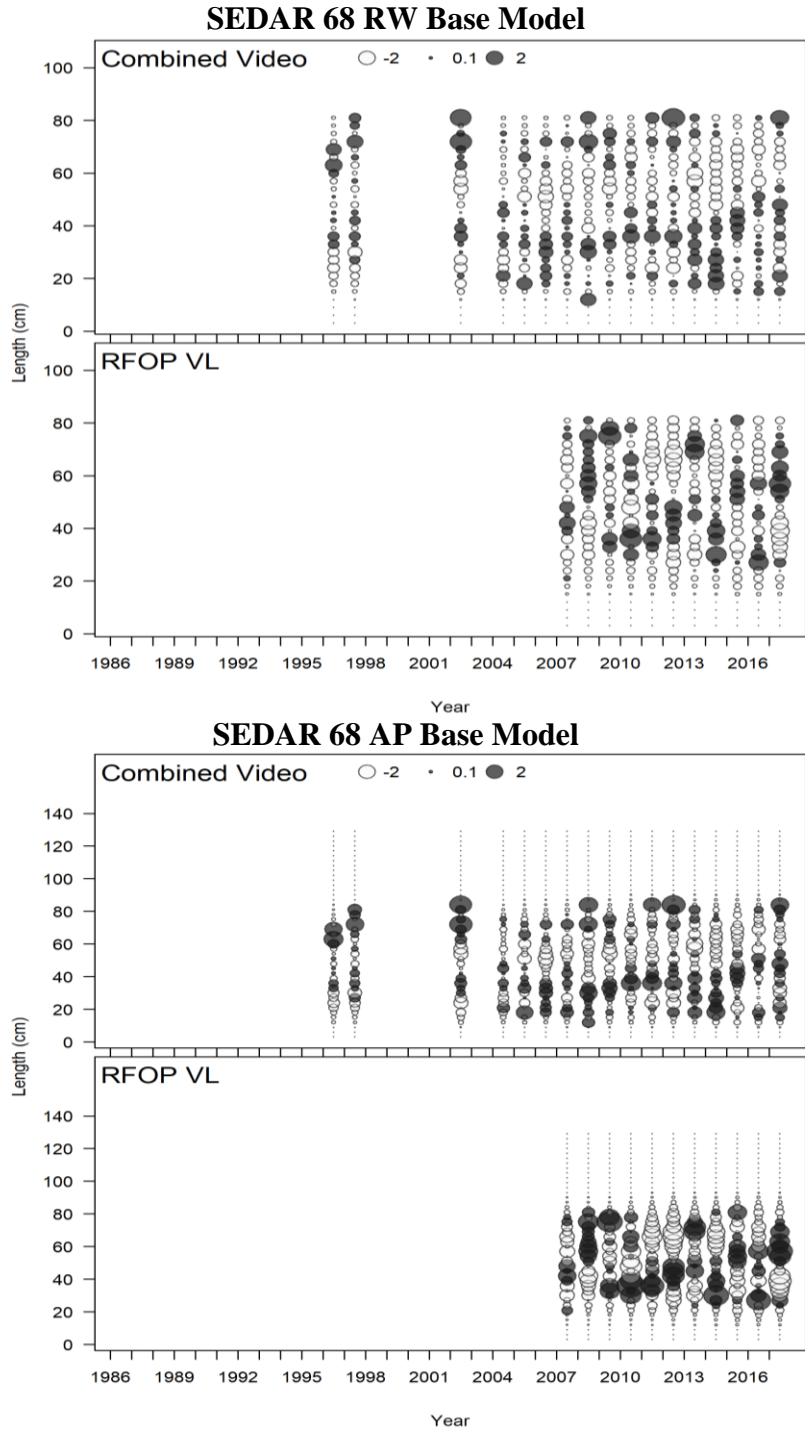
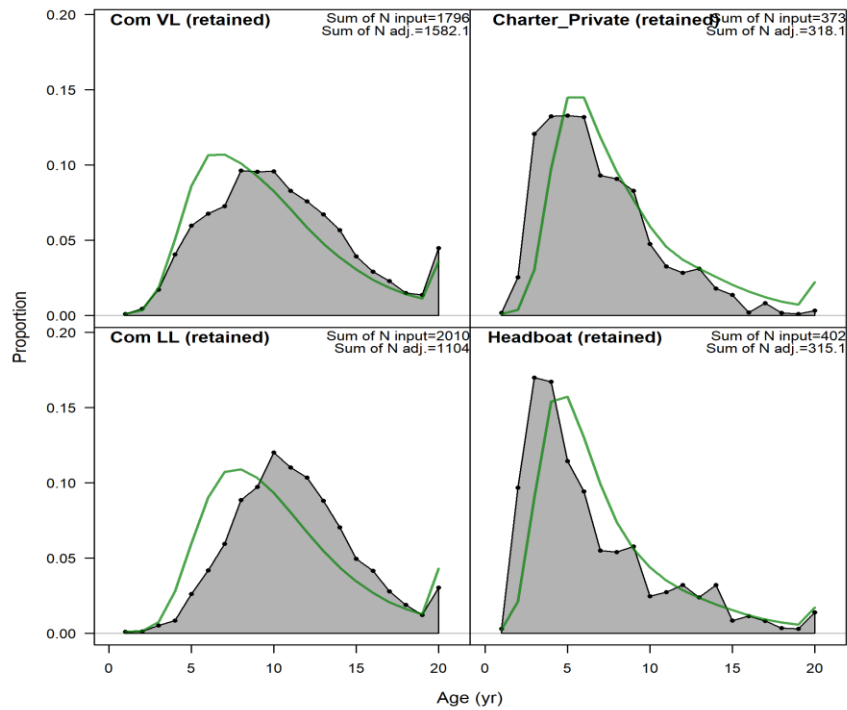

Figure 41 Continued. Pearson residuals for the length compositions of sampled Scamp for the Combined Video Survey and RFOP Vertical Line Survey in the Gulf of Mexico. Closed bubbles are positive residuals ($Obs > Exp$) and open bubbles are negative residuals ($Obs < Exp$). Range of residuals for the SEDAR 68 RW Base Model are -1.82 to 3.56 and -2.43 to 3.41 for the Combined Video Survey and RFOP Vertical Line Survey lengths, respectively. Range of residuals for the SEDAR 68 AP Base Model are -1.86 to 3.73 and -3.4 to 5.33 for the Combined Video Survey and RFOP Vertical Line Survey lengths, respectively.

SEDAR 68 RW Base Model



SEDAR 68 AP Base Model

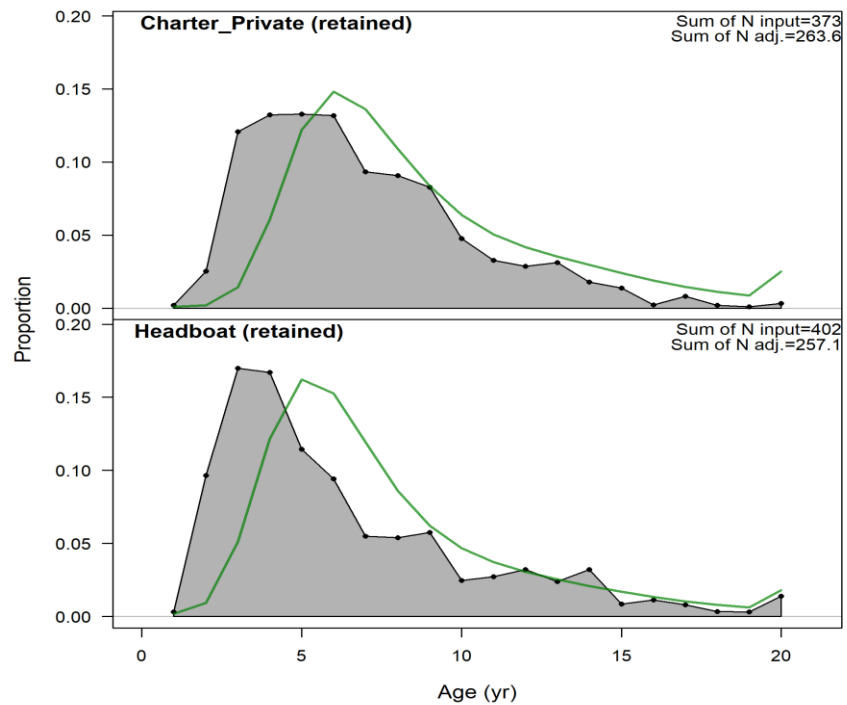

Figure 42. Comparison of model fits to the age compositions of landed Scamp aggregated across years within a given fleet for the Gulf of Mexico. Green lines represent expected age compositions, while grey shaded regions represent observed age compositions. The input (N input) and adjusted (N adj) sample sizes are provided in the upper right corner of each panel.

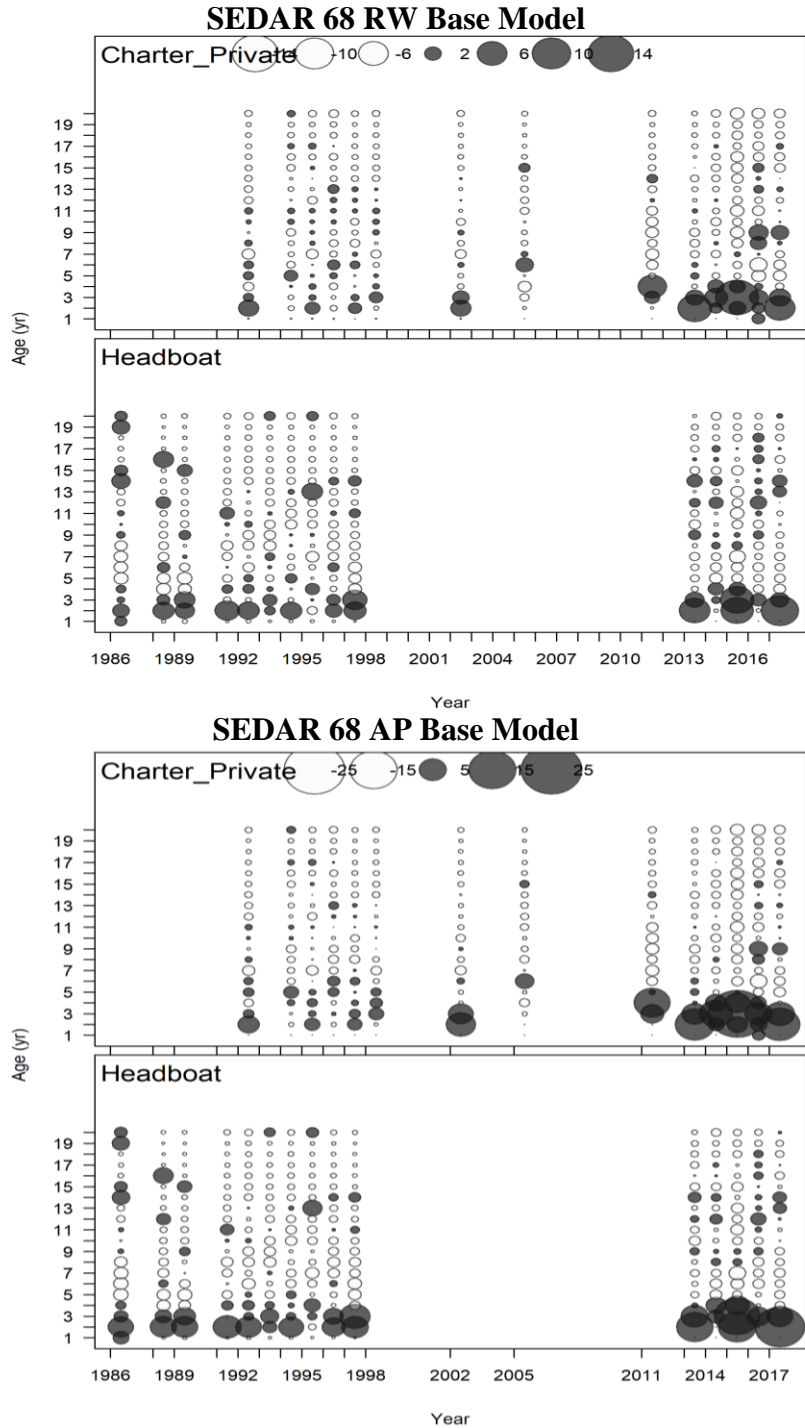

Figure 43. Pearson residuals for the age compositions of landed Scamp for each recreational fleet for the Gulf of Mexico. Closed bubbles are positive residuals ($Obs > Exp$) and open bubbles are negative residuals ($Obs < Exp$). Range of residuals for the SEDAR 68 RW Base Model are -2.08 to 12.53 and -1.83 to 9.45 for the Recreational Charter Private and Recreational Headboat ages, respectively. Range of residuals for the SEDAR 68 AP Base Model are -1.98 to 23.24 and -1.98 to 16.78 for the Recreational Charter Private and Recreational Headboat ages, respectively.

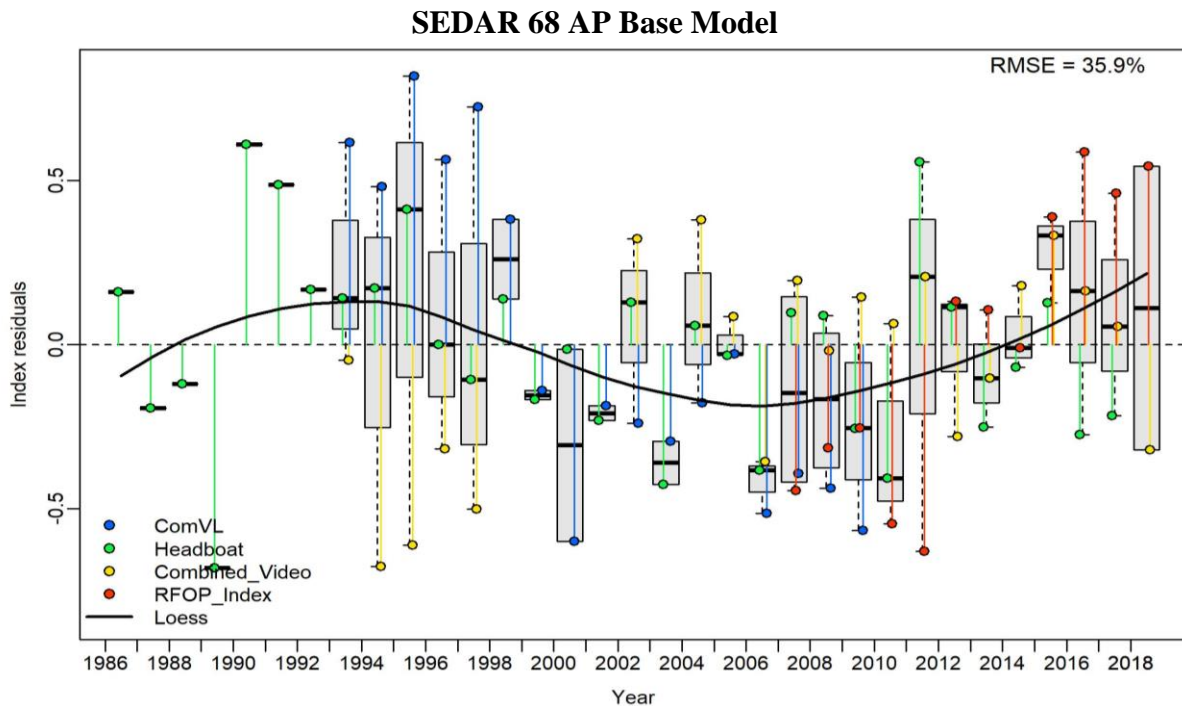
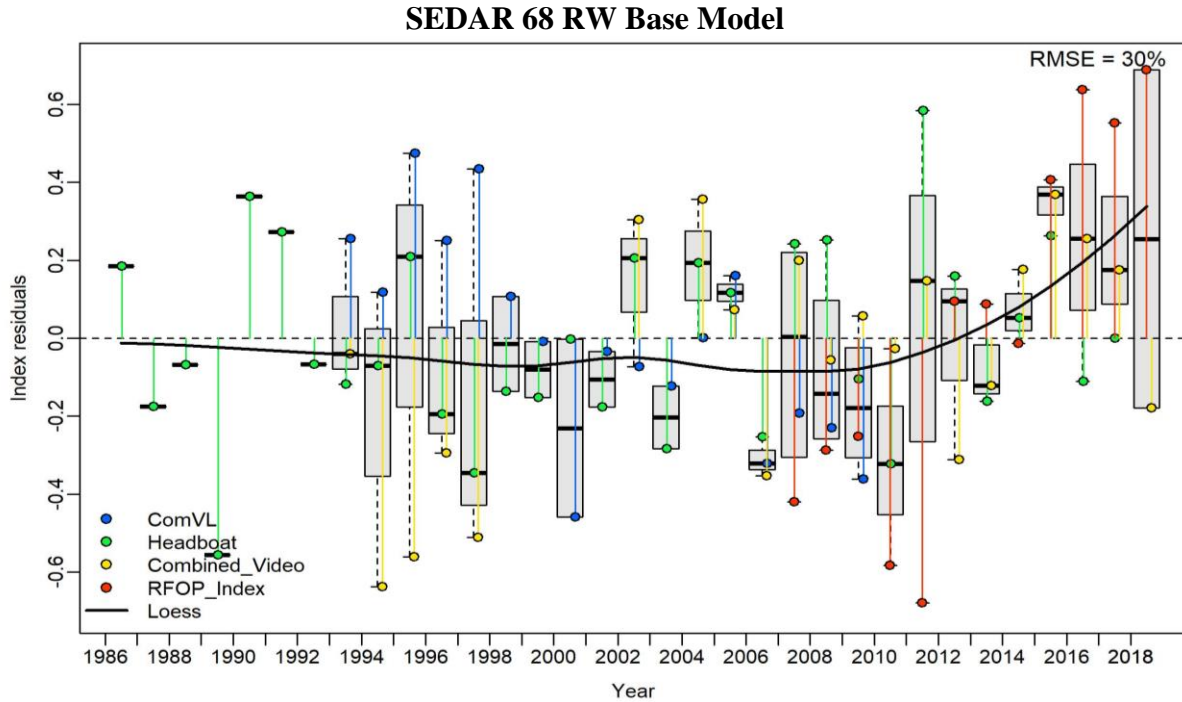

Figure 44A. Joint residual plots for indices of abundance fits for Gulf of Mexico Scamp. Vertical lines with points show the residuals (in colors by index), and solid black line reflects the loess smoother through all the residuals. Boxplots indicate the median and quantiles in cases where residuals from the multiple indices are available for any given year. Root-mean squared errors (RMSE) are included in the upper right-hand corner of each plot. See Carvalho et al. (2021) for additional details.

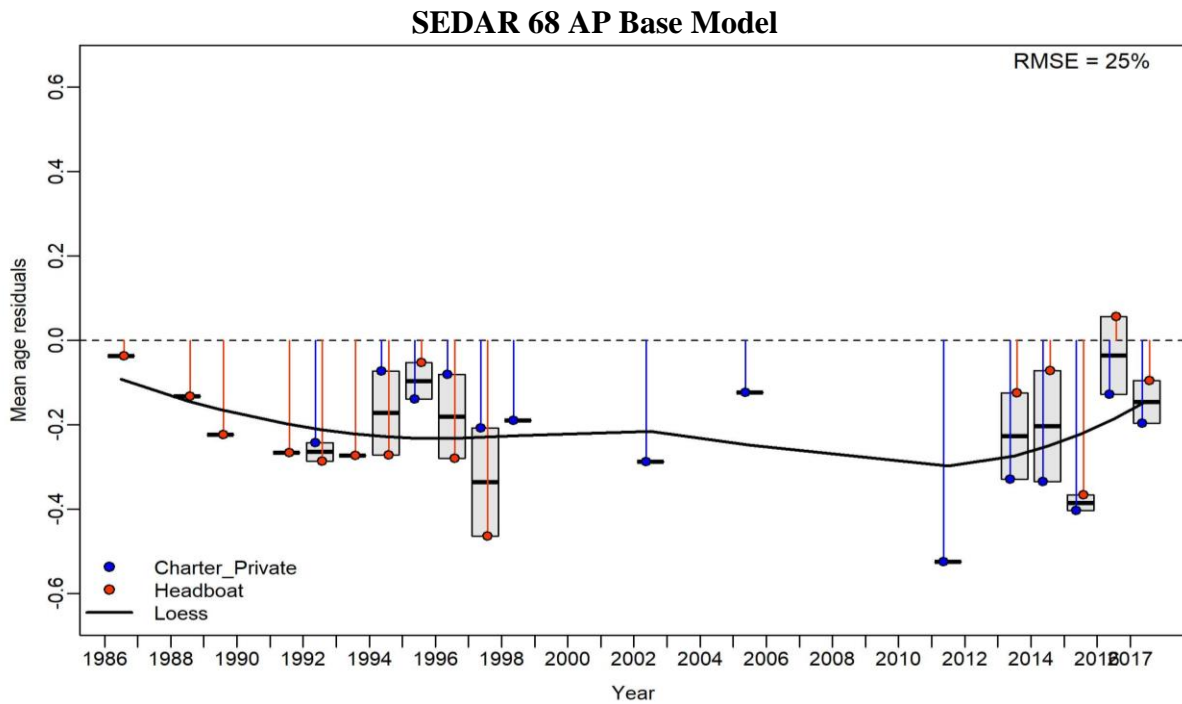
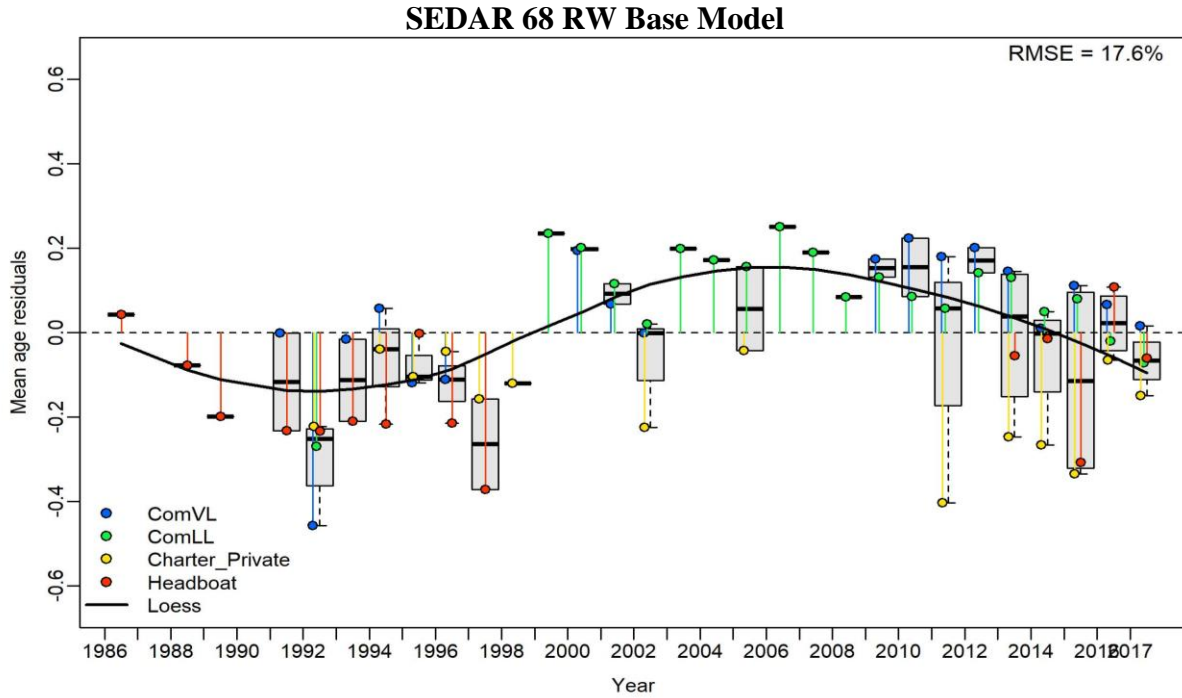

Figure 44B. Joint residual plots for annual mean age estimates for Gulf of Mexico Scamp. Vertical lines with points show the residuals (in colors by fleet), and solid black line reflects the loess smoother through all the residuals. Boxplots indicate the median and quantiles in cases where residuals from the multiple indices are available for any given year. Root-mean squared errors (RMSE) are included in the upper right-hand corner of each plot. See Carvalho et al. (2021) for additional details.

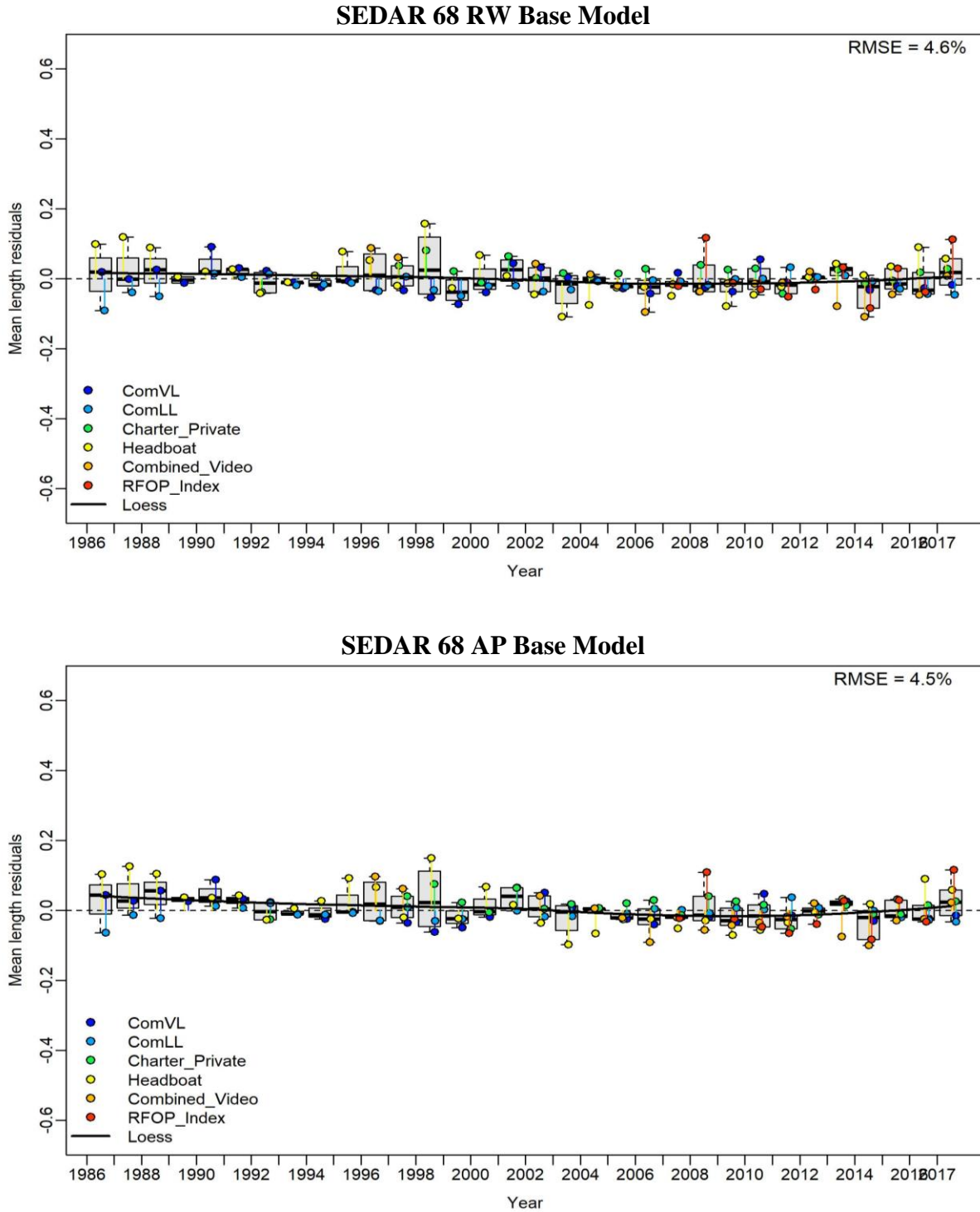
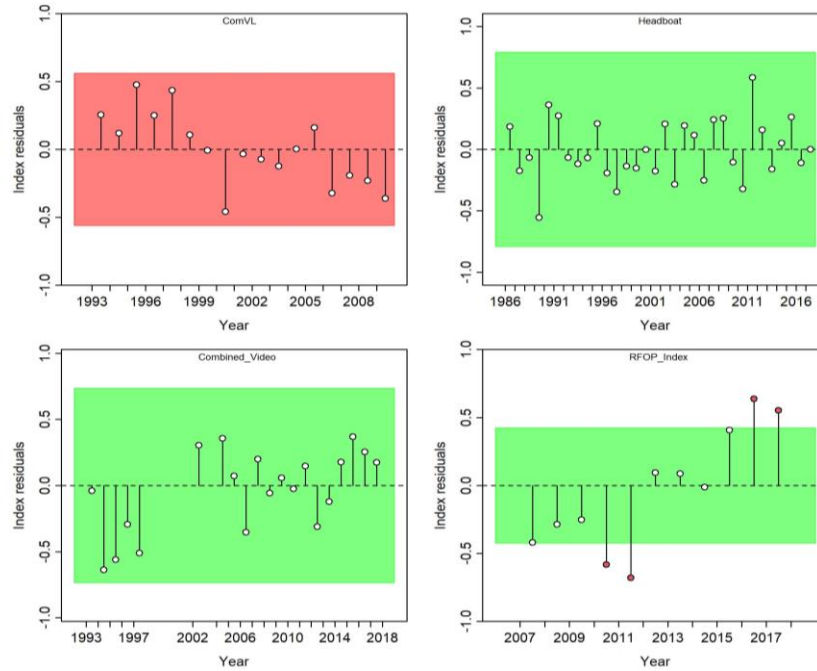

Figure 44C. Joint residual plots for annual mean length estimates for Gulf of Mexico Scamp. Vertical lines with points show the residuals (in colors by fleet or survey), and solid black line reflects the loess smoother through all the residuals. Boxplots indicate the median and quantiles in cases where residuals from the multiple indices are available for any given year. Root-mean squared errors (RMSE) are included in the upper right-hand corner of each plot. See Carvalho et al. (2021) for additional details.

SEDAR 68 RW Base Model



SEDAR 68 AP Base Model

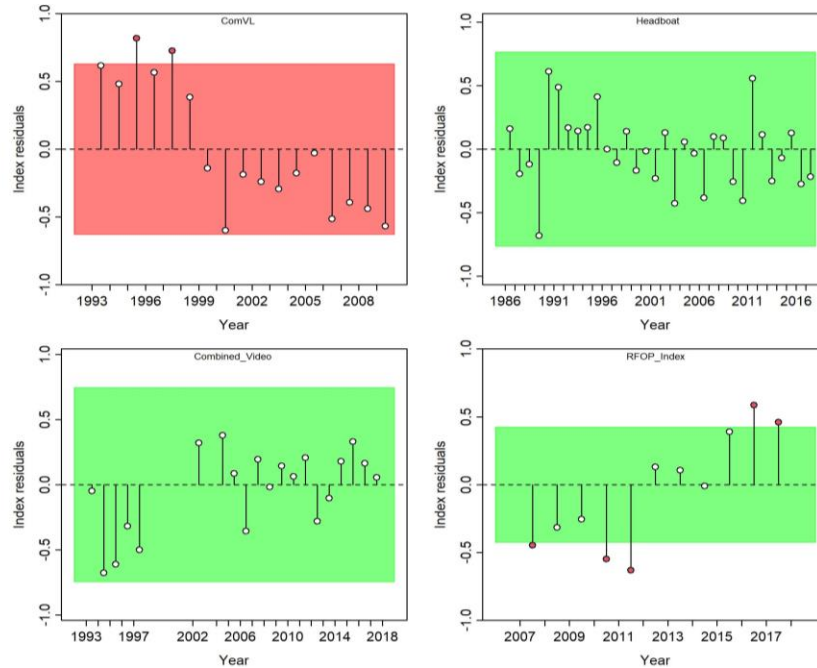
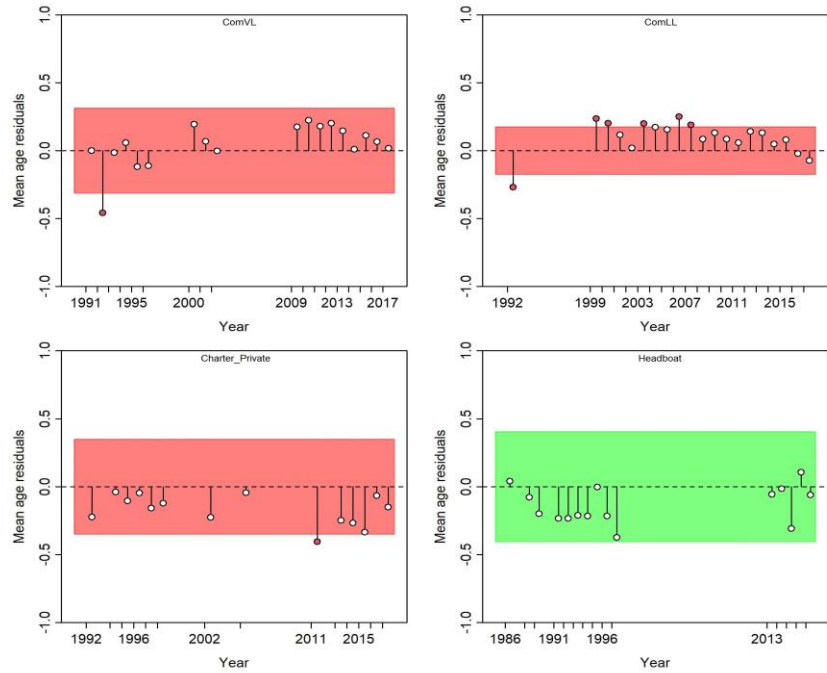

Figure 45A. Runs tests results for indices of abundance for Gulf of Mexico Scamp. Green shading indicates no evidence ($p \geq 0.05$) and red shading evidence ($p < 0.05$) to reject the hypothesis of a randomly distributed time-series of residuals, respectively. The shaded (green/red) area spans three residual standard deviations to either side from zero, and the red points outside of the shading violate the 'three-sigma limit' for that series. See Carvalho et al. (2021) for additional details.

SEDAR 68 RW Base Model



SEDAR 68 AP Base Model

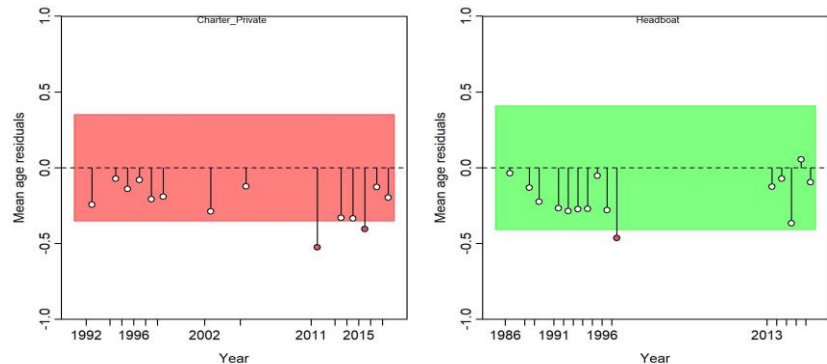

Figure 45B. Runs tests results for mean age of age composition data for Gulf of Mexico Scamp. Green shading indicates no evidence ($p \geq 0.05$) and red shading evidence ($p < 0.05$) to reject the hypothesis of a randomly distributed time-series of residuals, respectively. The shaded (green/red) area spans three residual standard deviations to either side from zero, and the red points outside of the shading violate the ‘three-sigma limit’ for that series. See Carvalho et al. (2021) for additional details.

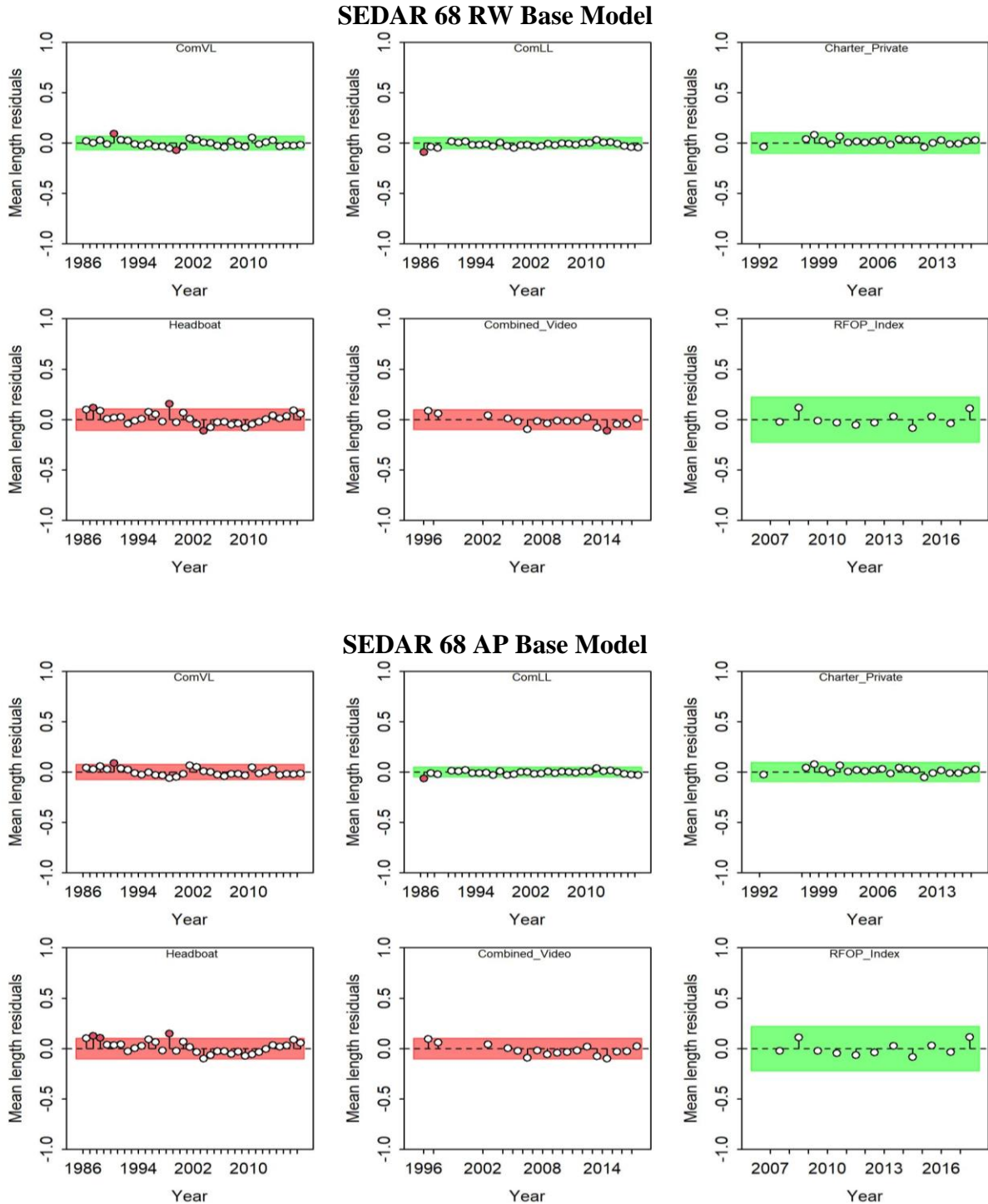

Figure 45C. Runs tests results for mean length of length composition data for Gulf of Mexico Scamp. Green shading indicates no evidence ($p \geq 0.05$) and red shading evidence ($p < 0.05$) to reject the hypothesis of a randomly distributed time-series of residuals, respectively. The shaded (green/red) area spans three residual standard deviations to either side from zero, and the red points outside of the shading violate the ‘three-sigma limit’ for that series. See Carvalho et al. (2021) for additional details.

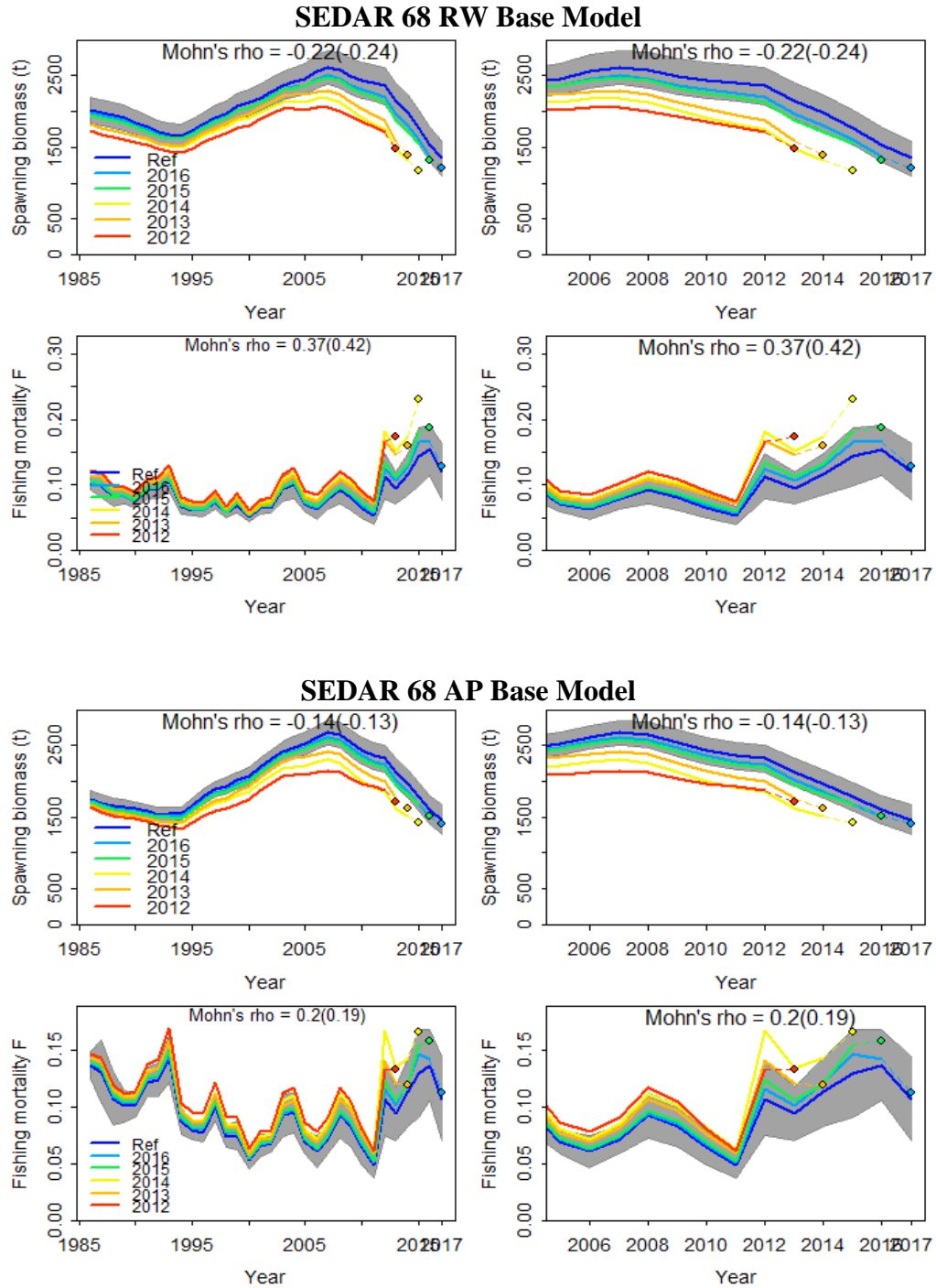

Figure 46. Retrospective analysis of spawning stock biomass (SSB, top panels) and fishing mortality (F, bottom panels) estimates for Gulf of Mexico Scamp conducted by re-fitting each reference model (Ref) after removing five years of observations, one year at a time sequentially. The retrospective results are shown for the entire time series and for the most recent years only. Mohn's rho statistic and the corresponding 'hindcast rho' values (in brackets) are printed at the top of each panel. One-year-ahead projections denoted by color-coded dashed lines with terminal points shown for each model. Grey shaded areas are the 95% confidence intervals from the reference model. See Carvalho et al. (2021) for additional details.

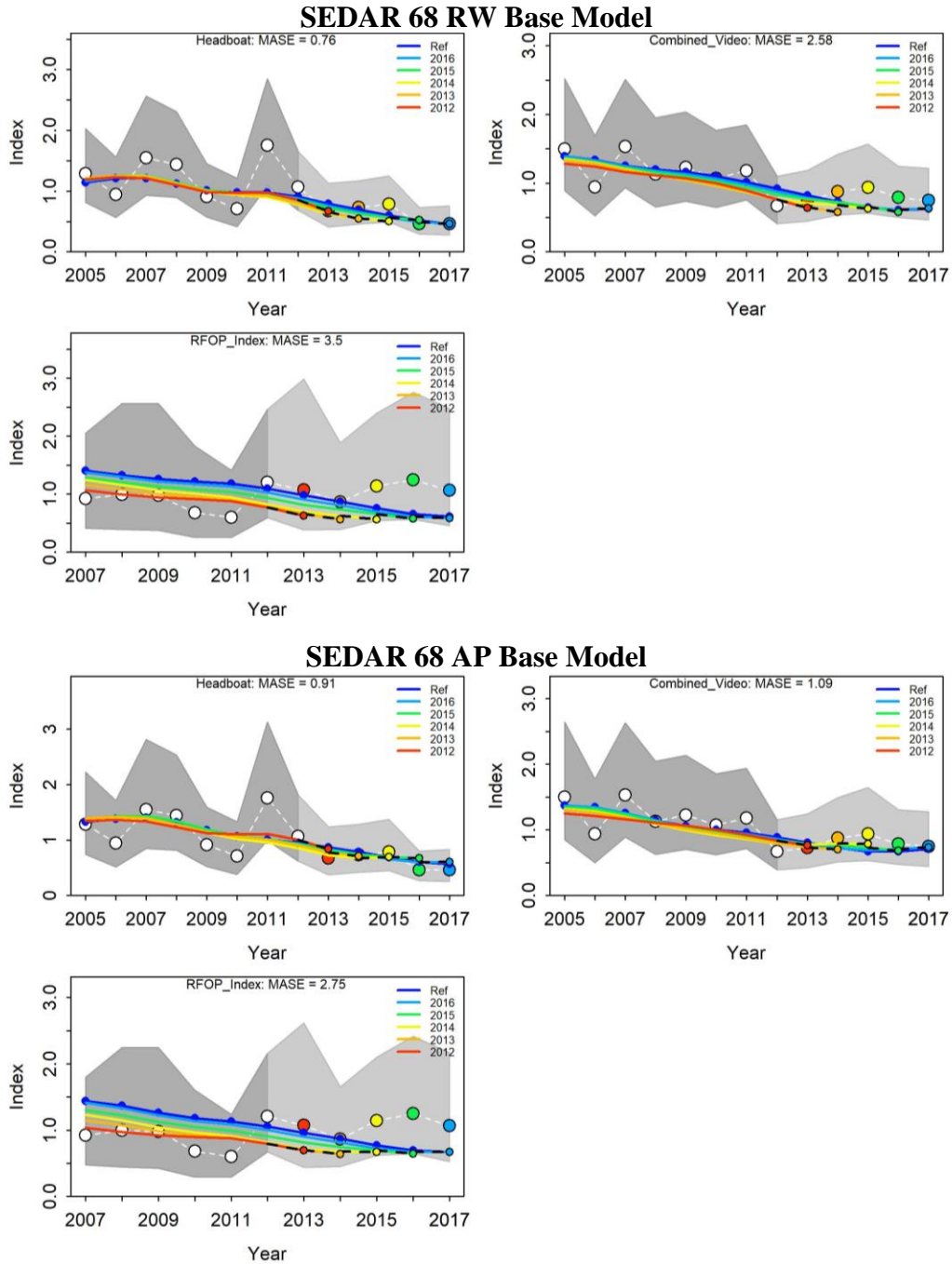

Figure 47A. Hindcasting cross-validation (HCxval) results for indices of abundance fits for Gulf of Mexico Scamp. Shown are observed (large points connected with dashed line), fitted (solid lines) and one-year ahead forecast values (small terminal points). HCxval was performed using one reference model (Ref) and five hindcast model runs (solid lines) relative to the expected index. The observations used for cross validation are highlighted as color-coded solid circles with associated 95% confidence intervals (light-grey shading). The model reference year refers to the endpoints of each one-year-ahead forecast and the corresponding observation (i.e., year of peel + 1). The mean absolute scaled error (MASE) score associated with each index time series is denoted in each panel. See Carvalho et al. (2021) for additional details.

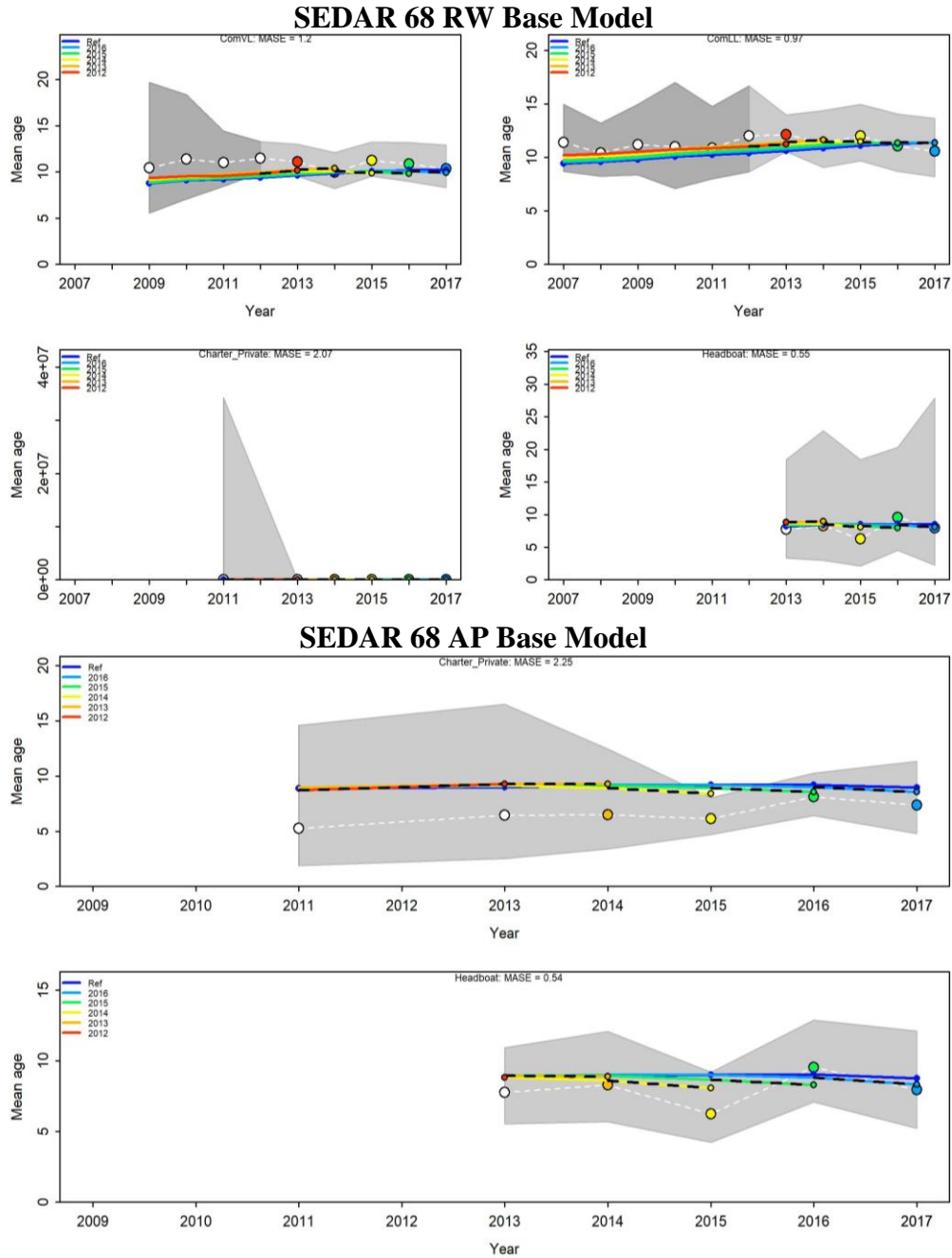

Figure 47B. Hindcasting cross-validation (HCxval) results for fits to annual mean age estimates for Gulf of Mexico Scamp. Shown are observed (large points connected with dashed line), fitted (solid lines) and one-year ahead forecast values (small terminal points). HCxval was performed using one reference model (Ref) and five hindcast model runs (solid lines) relative to the expected mean age. The observations used for cross-validation are highlighted as color-coded solid circles with associated 95% confidence intervals (light-grey shading). The model reference year refers to the endpoints of each one-year-ahead forecast and the corresponding observation (i.e., year of peel + 1). The mean absolute scaled error (MASE) score associated with each age composition time series is denoted in each panel. See Carvalho et al. (2021) for additional details.

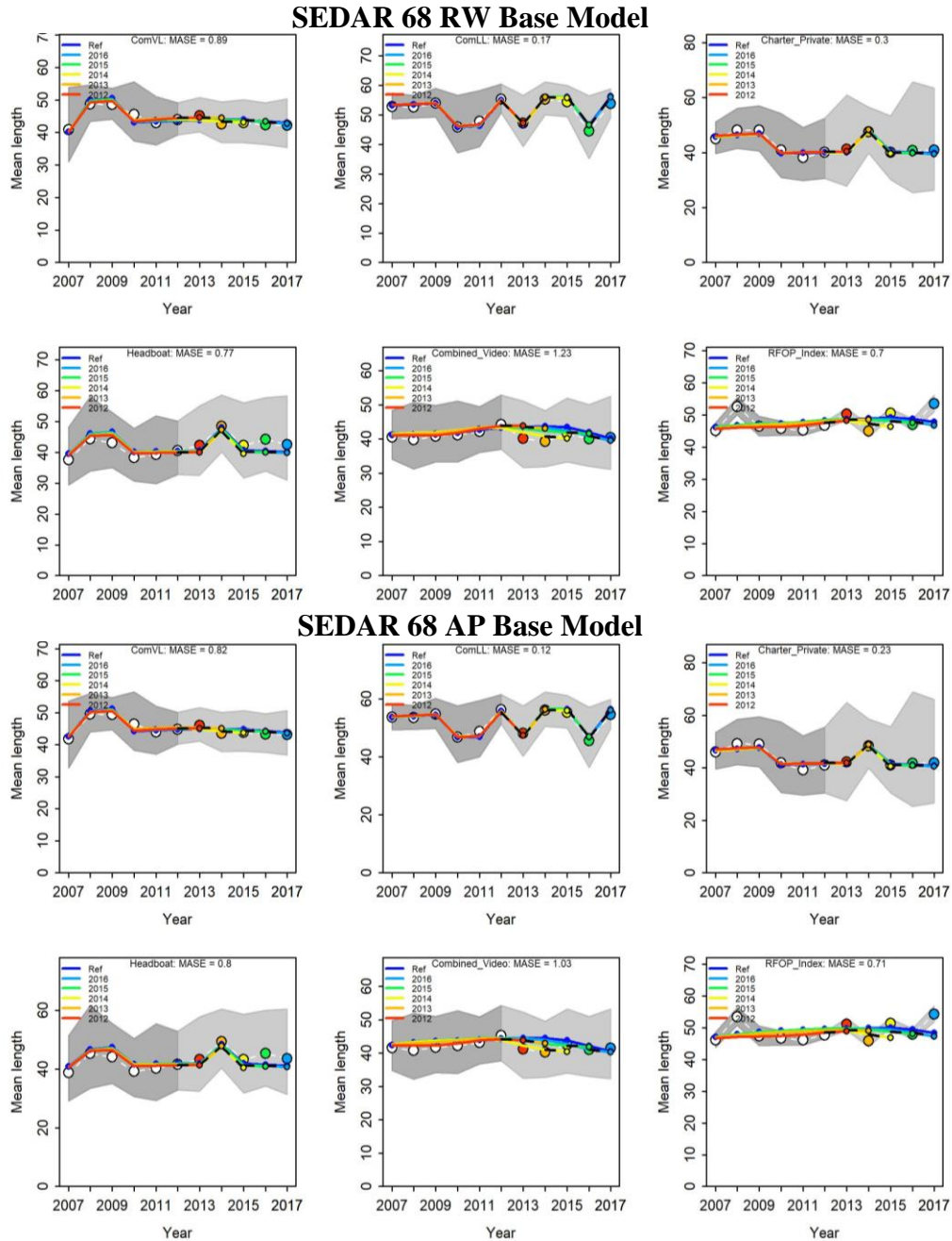

Figure 47C. Hindcasting cross-validation (HCxval) results for fits to annual mean length estimates for Gulf of Mexico Scamp. Shown are observed (large points connected with dashed line), fitted (solid lines) and one-year ahead forecast values (small terminal points). HCxval was performed using one reference model (Ref) and five hindcast model runs (solid lines) relative to the expected mean length. The observations used for cross-validation are highlighted as color-coded solid circles with associated 95% confidence intervals (light-grey shading). The model reference year refers to the endpoints of each one-year-ahead forecast and the corresponding observation (i.e., year of peel + 1). The mean absolute scaled error (MASE) score associated with each size composition time series is denoted in each panel. See Carvalho et al. (2021) for additional details.

11. Appendix: SEDAR 68 RW Base Model

The following sections include only Tables and Figures which have changed from those provided in the SEDAR 68 AP Report. Tables and Figures provided below have retained the original numbers that correspond to the SEDAR 68 AP Report, making it easier to compare results between Base Models.

11.1 SEDAR 68 RW Base Model Tables

Table RW3. Age-specific natural mortality (per year) for Gulf of Mexico Scamp. Female and male natural mortality were assumed equivalent.

| Age | RW Base <i>M</i> |
|-----|------------------|
| 0 | 0.5398 |
| 1 | 0.3955 |
| 2 | 0.3209 |
| 3 | 0.2756 |
| 4 | 0.2454 |
| 5 | 0.2239 |
| 6 | 0.2080 |
| 7 | 0.1958 |
| 8 | 0.1863 |
| 9 | 0.1787 |
| 10 | 0.1725 |
| 11 | 0.1675 |
| 12 | 0.1633 |
| 13 | 0.1598 |
| 14 | 0.1569 |
| 15 | 0.1544 |
| 16 | 0.1523 |
| 17 | 0.1505 |
| 18 | 0.1490 |
| 19 | 0.1477 |

Table RW3 Continued. Age-specific natural mortality (per year) for Gulf of Mexico Scamp. Female and male natural mortality were assumed equivalent.

| Age | RW Base M |
|-----|-----------|
| 20 | 0.1466 |
| 21 | 0.1456 |
| 22 | 0.1447 |
| 23 | 0.1440 |
| 24 | 0.1434 |
| 25 | 0.1428 |
| 26 | 0.1424 |
| 27 | 0.1420 |
| 28 | 0.1416 |
| 29 | 0.1413 |
| 30 | 0.1410 |
| 31 | 0.1408 |
| 32 | 0.1406 |
| 33 | 0.1404 |
| 34 | 0.1404 |

Table RW10. List of SS parameters for Gulf of Mexico Scamp. The list includes expected parameter values, lower and upper bounds of the parameters, associated standard deviations (SD) and coefficients of variation (CV), the prior type and densities (value, SD) assigned to the parameters as applicable, and phases (negative identifies parameters that were fixed). Parameters designated as fixed were held at their initial values and have no associated range or SD.

| Label | Value | Range | SD | CV | Prior | Phase |
|----------------------|-----------|------------|-------|-------|-------|-------|
| L_at_Amin_Fem_GP_1 | 15.2372 | (1,40) | 0.526 | 0.035 | | 2 |
| L_at_Amax_Fem_GP_1 | 70.222 | (60,100) | | | | -4 |
| VonBert_K_Fem_GP_1 | 0.1341 | (0.05,0.3) | | | | -4 |
| CV_young_Fem_GP_1 | 0.1298 | (0.01,0.5) | | | | -3 |
| CV_old_Fem_GP_1 | 0.1298 | (0.01,0.5) | | | | -3 |
| Wtlen_1_Fem_GP_1 | 0 | (0,1) | | | | -2 |
| Wtlen_2_Fem_GP_1 | 3.04 | (0,4) | | | | -3 |
| Mat50%_Fem_GP_1 | 3.4068 | (1,10) | | | | -3 |
| Mat_slope_Fem_GP_1 | -1.3346 | (-10,0) | | | | -3 |
| Eggs_scalar_Fem_GP_1 | 1 | (-1,1) | | | | -3 |
| Eggs_exp_wt_Fem_GP_1 | 1 | (0,4) | | | | -3 |
| L_at_Amin_Mal_GP_1 | 0 | (-1,1) | | | | -3 |
| L_at_Amax_Mal_GP_1 | 0 | (-1,1) | | | | -4 |
| VonBert_K_Mal_GP_1 | 0 | (-1,1) | | | | -4 |
| CV_young_Mal_GP_1 | 0 | (-1,1) | | | | -3 |
| CV_old_Mal_GP_1 | 0 | (-1,1) | | | | -3 |
| Wtlen_1_Mal_GP_1 | 1.186e-05 | (0,1) | | | | -2 |
| Wtlen_2_Mal_GP_1 | 3.04 | (0,4) | | | | -3 |
| Herm_Infl_age | 21.5253 | (10,34) | | | | -4 |
| Herm_stdev | 10.1407 | (1,20) | | | | -4 |
| Herm_asymptote | 0.8907 | (0,1) | | | | -4 |
| CohortGrowDev | 1 | (0.1,10) | | | | -1 |
| FracFemale_GP_1 | 1 | (1e-06,1) | | | | -99 |
| SR_LN(R0) | 7.4169 | (1,40) | 0.028 | 0.004 | | 1 |
| SR_BH_steep | 0.6935 | (0.2,0.99) | | | | -3 |
| SR_sigmaR | 0.4454 | (0,2) | 0.057 | 0.128 | | 4 |
| SR_regime | 0 | (-5,5) | | | | -4 |
| SR_autocorr | 0 | (0,0.5) | | | | -99 |

Table RW10 Continued. List of SS parameters for Gulf of Mexico Scamp.

| Label | Value | Range | SD | CV | Prior | Phase |
|------------------------|---------|--------|-------|--------|-------|-------|
| Main_RecrDev_1986 | -0.9418 | (-5,5) | 0.294 | -0.312 | | 2 |
| Main_RecrDev_1987 | -0.4177 | (-5,5) | 0.234 | -0.56 | | 2 |
| Main_RecrDev_1988 | -0.4313 | (-5,5) | 0.267 | -0.619 | | 2 |
| Main_RecrDev_1989 | 0.2452 | (-5,5) | 0.184 | 0.75 | | 2 |
| Main_RecrDev_1990 | 0.354 | (-5,5) | 0.196 | 0.554 | | 2 |
| Main_RecrDev_1991 | 0.185 | (-5,5) | 0.251 | 1.357 | | 2 |
| Main_RecrDev_1992 | 0.1121 | (-5,5) | 0.304 | 2.712 | | 2 |
| Main_RecrDev_1993 | 0.3619 | (-5,5) | 0.286 | 0.79 | | 2 |
| Main_RecrDev_1994 | 0.363 | (-5,5) | 0.311 | 0.857 | | 2 |
| Main_RecrDev_1995 | 0.0876 | (-5,5) | 0.377 | 4.303 | | 2 |
| Main_RecrDev_1996 | 0.5059 | (-5,5) | 0.245 | 0.484 | | 2 |
| Main_RecrDev_1997 | -0.1596 | (-5,5) | 0.373 | -2.336 | | 2 |
| Main_RecrDev_1998 | 0.0904 | (-5,5) | 0.357 | 3.948 | | 2 |
| Main_RecrDev_1999 | 0.9493 | (-5,5) | 0.215 | 0.226 | | 2 |
| Main_RecrDev_2000 | 0.0328 | (-5,5) | 0.558 | 17.002 | | 2 |
| Main_RecrDev_2001 | 0.7729 | (-5,5) | 0.331 | 0.428 | | 2 |
| Main_RecrDev_2002 | 0.531 | (-5,5) | 0.358 | 0.674 | | 2 |
| Main_RecrDev_2003 | 0.3453 | (-5,5) | 0.322 | 0.933 | | 2 |
| Main_RecrDev_2004 | -0.2013 | (-5,5) | 0.334 | -1.659 | | 2 |
| Main_RecrDev_2005 | -0.0651 | (-5,5) | 0.26 | -3.991 | | 2 |
| Main_RecrDev_2006 | 0.3187 | (-5,5) | 0.177 | 0.555 | | 2 |
| Main_RecrDev_2007 | 0.1872 | (-5,5) | 0.172 | 0.919 | | 2 |
| Main_RecrDev_2008 | -0.4571 | (-5,5) | 0.221 | -0.483 | | 2 |
| Main_RecrDev_2009 | -0.3949 | (-5,5) | 0.173 | -0.438 | | 2 |
| Main_RecrDev_2010 | -0.4675 | (-5,5) | 0.164 | -0.351 | | 2 |
| Main_RecrDev_2011 | -0.3987 | (-5,5) | 0.149 | -0.374 | | 2 |
| Main_RecrDev_2012 | -0.8188 | (-5,5) | 0.209 | -0.255 | | 2 |
| Main_RecrDev_2013 | -0.6199 | (-5,5) | 0.205 | -0.331 | | 2 |
| Main_RecrDev_2014 | -0.0686 | (-5,5) | 0.188 | -2.74 | | 2 |
| Late_RecrDev_2015 | 0 | | | | | |
| Late_RecrDev_2016 | 0 | | | | | |
| Late_RecrDev_2017 | 0 | | | | | |
| InitF_seas_1flt_1ComVL | 0.0502 | (0,1) | 0.004 | 0.08 | | 1 |

Table RW10 Continued. List of SS parameters for Gulf of Mexico Scamp.

| Label | Value | Range | SD | CV | Prior | Phase |
|-----------------------------------|--------|-------|-------|-------|-------|-------|
| InitF_seas_1_flt_2ComLL | 0.0532 | (0,1) | 0.005 | 0.094 | | 1 |
| InitF_seas_1_flt_3Charter_Private | 0.0292 | (0,1) | 0.002 | 0.068 | | 1 |
| F_fleet_1_YR_1986_s_1 | 0.0545 | (0,4) | 0.004 | 0.073 | | 1 |
| F_fleet_1_YR_1987_s_1 | 0.0562 | (0,4) | 0.005 | 0.089 | | 1 |
| F_fleet_1_YR_1988_s_1 | 0.0489 | (0,4) | 0.004 | 0.082 | | 1 |
| F_fleet_1_YR_1989_s_1 | 0.0508 | (0,4) | 0.004 | 0.079 | | 1 |
| F_fleet_1_YR_1990_s_1 | 0.0508 | (0,4) | 0.004 | 0.079 | | 1 |
| F_fleet_1_YR_1991_s_1 | 0.0626 | (0,4) | 0.005 | 0.08 | | 1 |
| F_fleet_1_YR_1992_s_1 | 0.0802 | (0,4) | 0.007 | 0.087 | | 1 |
| F_fleet_1_YR_1993_s_1 | 0.0816 | (0,4) | 0.007 | 0.086 | | 1 |
| F_fleet_1_YR_1994_s_1 | 0.0598 | (0,4) | 0.005 | 0.084 | | 1 |
| F_fleet_1_YR_1995_s_1 | 0.0639 | (0,4) | 0.005 | 0.078 | | 1 |
| F_fleet_1_YR_1996_s_1 | 0.0579 | (0,4) | 0.005 | 0.086 | | 1 |
| F_fleet_1_YR_1997_s_1 | 0.071 | (0,4) | 0.006 | 0.085 | | 1 |
| F_fleet_1_YR_1998_s_1 | 0.0431 | (0,4) | 0.003 | 0.07 | | 1 |
| F_fleet_1_YR_1999_s_1 | 0.0514 | (0,4) | 0.004 | 0.078 | | 1 |
| F_fleet_1_YR_2000_s_1 | 0.0358 | (0,4) | 0.003 | 0.084 | | 1 |
| F_fleet_1_YR_2001_s_1 | 0.0424 | (0,4) | 0.003 | 0.071 | | 1 |
| F_fleet_1_YR_2002_s_1 | 0.0495 | (0,4) | 0.004 | 0.081 | | 1 |
| F_fleet_1_YR_2003_s_1 | 0.0461 | (0,4) | 0.004 | 0.087 | | 1 |
| F_fleet_1_YR_2004_s_1 | 0.0435 | (0,4) | 0.003 | 0.069 | | 1 |
| F_fleet_1_YR_2005_s_1 | 0.0422 | (0,4) | 0.003 | 0.071 | | 1 |
| F_fleet_1_YR_2006_s_1 | 0.0319 | (0,4) | 0.003 | 0.094 | | 1 |
| F_fleet_1_YR_2007_s_1 | 0.036 | (0,4) | 0.003 | 0.083 | | 1 |
| F_fleet_1_YR_2008_s_1 | 0.0324 | (0,4) | 0.003 | 0.093 | | 1 |
| F_fleet_1_YR_2009_s_1 | 0.0382 | (0,4) | 0.003 | 0.078 | | 1 |
| F_fleet_1_YR_2010_s_1 | 0.0226 | (0,4) | 0.001 | 0.044 | | 1 |
| F_fleet_1_YR_2011_s_1 | 0.0212 | (0,4) | 0.001 | 0.047 | | 1 |
| F_fleet_1_YR_2012_s_1 | 0.0403 | (0,4) | 0.003 | 0.074 | | 1 |
| F_fleet_1_YR_2013_s_1 | 0.0391 | (0,4) | 0.003 | 0.077 | | 1 |
| F_fleet_1_YR_2014_s_1 | 0.032 | (0,4) | 0.002 | 0.063 | | 1 |
| F_fleet_1_YR_2015_s_1 | 0.0331 | (0,4) | 0.003 | 0.091 | | 1 |
| F_fleet_1_YR_2016_s_1 | 0.0561 | (0,4) | 0.005 | 0.089 | | 1 |

Table RW10 Continued. List of SS parameters for Gulf of Mexico Scamp.

| Label | Value | Range | SD | CV | Prior | Phase |
|-----------------------|--------|-------|-------|-------|-------|-------|
| F_fleet_1_YR_2017_s_1 | 0.0386 | (0,4) | 0.004 | 0.104 | | 1 |
| F_fleet_2_YR_1986_s_1 | 0.0692 | (0,4) | 0.006 | 0.087 | | 1 |
| F_fleet_2_YR_1987_s_1 | 0.0626 | (0,4) | 0.005 | 0.08 | | 1 |
| F_fleet_2_YR_1988_s_1 | 0.0453 | (0,4) | 0.004 | 0.088 | | 1 |
| F_fleet_2_YR_1989_s_1 | 0.0522 | (0,4) | 0.004 | 0.077 | | 1 |
| F_fleet_2_YR_1990_s_1 | 0.0454 | (0,4) | 0.004 | 0.088 | | 1 |
| F_fleet_2_YR_1991_s_1 | 0.0548 | (0,4) | 0.005 | 0.091 | | 1 |
| F_fleet_2_YR_1992_s_1 | 0.0336 | (0,4) | 0.003 | 0.089 | | 1 |
| F_fleet_2_YR_1993_s_1 | 0.0479 | (0,4) | 0.004 | 0.084 | | 1 |
| F_fleet_2_YR_1994_s_1 | 0.0278 | (0,4) | 0.003 | 0.108 | | 1 |
| F_fleet_2_YR_1995_s_1 | 0.0291 | (0,4) | 0.003 | 0.103 | | 1 |
| F_fleet_2_YR_1996_s_1 | 0.0308 | (0,4) | 0.003 | 0.097 | | 1 |
| F_fleet_2_YR_1997_s_1 | 0.0354 | (0,4) | 0.003 | 0.085 | | 1 |
| F_fleet_2_YR_1998_s_1 | 0.0363 | (0,4) | 0.003 | 0.083 | | 1 |
| F_fleet_2_YR_1999_s_1 | 0.0343 | (0,4) | 0.003 | 0.087 | | 1 |
| F_fleet_2_YR_2000_s_1 | 0.0282 | (0,4) | 0.002 | 0.071 | | 1 |
| F_fleet_2_YR_2001_s_1 | 0.0409 | (0,4) | 0.003 | 0.073 | | 1 |
| F_fleet_2_YR_2002_s_1 | 0.0418 | (0,4) | 0.003 | 0.072 | | 1 |
| F_fleet_2_YR_2003_s_1 | 0.048 | (0,4) | 0.004 | 0.083 | | 1 |
| F_fleet_2_YR_2004_s_1 | 0.0534 | (0,4) | 0.004 | 0.075 | | 1 |
| F_fleet_2_YR_2005_s_1 | 0.0492 | (0,4) | 0.004 | 0.081 | | 1 |
| F_fleet_2_YR_2006_s_1 | 0.0286 | (0,4) | 0.002 | 0.07 | | 1 |
| F_fleet_2_YR_2007_s_1 | 0.038 | (0,4) | 0.003 | 0.079 | | 1 |
| F_fleet_2_YR_2008_s_1 | 0.0429 | (0,4) | 0.004 | 0.093 | | 1 |
| F_fleet_2_YR_2009_s_1 | 0.0277 | (0,4) | 0.002 | 0.072 | | 1 |
| F_fleet_2_YR_2010_s_1 | 0.0203 | (0,4) | 0.001 | 0.049 | | 1 |
| F_fleet_2_YR_2011_s_1 | 0.0187 | (0,4) | 0.001 | 0.053 | | 1 |
| F_fleet_2_YR_2012_s_1 | 0.0297 | (0,4) | 0.002 | 0.067 | | 1 |
| F_fleet_2_YR_2013_s_1 | 0.035 | (0,4) | 0.003 | 0.086 | | 1 |
| F_fleet_2_YR_2014_s_1 | 0.0226 | (0,4) | 0.002 | 0.088 | | 1 |
| F_fleet_2_YR_2015_s_1 | 0.0329 | (0,4) | 0.003 | 0.091 | | 1 |
| F_fleet_2_YR_2016_s_1 | 0.0672 | (0,4) | 0.006 | 0.089 | | 1 |
| F_fleet_2_YR_2017_s_1 | 0.0414 | (0,4) | 0.004 | 0.097 | | 1 |

Table RW10 Continued. List of SS parameters for Gulf of Mexico Scamp.

| Label | Value | Range | SD | CV | Prior | Phase |
|-----------------------|--------|-------|-------|-------|-------|-------|
| F_fleet_3_YR_1986_s_1 | 0.0411 | (0,4) | 0.003 | 0.073 | | 1 |
| F_fleet_3_YR_1987_s_1 | 0.0418 | (0,4) | 0.014 | 0.335 | | 1 |
| F_fleet_3_YR_1988_s_1 | 0.0379 | (0,4) | 0.012 | 0.317 | | 1 |
| F_fleet_3_YR_1989_s_1 | 0.0186 | (0,4) | 0.006 | 0.323 | | 1 |
| F_fleet_3_YR_1990_s_1 | 0.0209 | (0,4) | 0.006 | 0.287 | | 1 |
| F_fleet_3_YR_1991_s_1 | 0.0284 | (0,4) | 0.01 | 0.352 | | 1 |
| F_fleet_3_YR_1992_s_1 | 0.0384 | (0,4) | 0.011 | 0.287 | | 1 |
| F_fleet_3_YR_1993_s_1 | 0.0582 | (0,4) | 0.017 | 0.292 | | 1 |
| F_fleet_3_YR_1994_s_1 | 0.0264 | (0,4) | 0.008 | 0.303 | | 1 |
| F_fleet_3_YR_1995_s_1 | 0.0081 | (0,4) | 0.002 | 0.248 | | 1 |
| F_fleet_3_YR_1996_s_1 | 0.0142 | (0,4) | 0.005 | 0.351 | | 1 |
| F_fleet_3_YR_1997_s_1 | 0.0198 | (0,4) | 0.006 | 0.304 | | 1 |
| F_fleet_3_YR_1998_s_1 | 0.0178 | (0,4) | 0.006 | 0.338 | | 1 |
| F_fleet_3_YR_1999_s_1 | 0.0381 | (0,4) | 0.012 | 0.315 | | 1 |
| F_fleet_3_YR_2000_s_1 | 0.0226 | (0,4) | 0.007 | 0.31 | | 1 |
| F_fleet_3_YR_2001_s_1 | 0.0271 | (0,4) | 0.008 | 0.295 | | 1 |
| F_fleet_3_YR_2002_s_1 | 0.0256 | (0,4) | 0.007 | 0.273 | | 1 |
| F_fleet_3_YR_2003_s_1 | 0.0796 | (0,4) | 0.02 | 0.251 | | 1 |
| F_fleet_3_YR_2004_s_1 | 0.0905 | (0,4) | 0.02 | 0.221 | | 1 |
| F_fleet_3_YR_2005_s_1 | 0.0375 | (0,4) | 0.009 | 0.24 | | 1 |
| F_fleet_3_YR_2006_s_1 | 0.0533 | (0,4) | 0.015 | 0.282 | | 1 |
| F_fleet_3_YR_2007_s_1 | 0.0634 | (0,4) | 0.014 | 0.221 | | 1 |
| F_fleet_3_YR_2008_s_1 | 0.0873 | (0,4) | 0.02 | 0.229 | | 1 |
| F_fleet_3_YR_2009_s_1 | 0.0764 | (0,4) | 0.019 | 0.249 | | 1 |
| F_fleet_3_YR_2010_s_1 | 0.0757 | (0,4) | 0.018 | 0.238 | | 1 |
| F_fleet_3_YR_2011_s_1 | 0.052 | (0,4) | 0.014 | 0.269 | | 1 |
| F_fleet_3_YR_2012_s_1 | 0.133 | (0,4) | 0.037 | 0.278 | | 1 |
| F_fleet_3_YR_2013_s_1 | 0.0906 | (0,4) | 0.025 | 0.276 | | 1 |
| F_fleet_3_YR_2014_s_1 | 0.1612 | (0,4) | 0.034 | 0.211 | | 1 |
| F_fleet_3_YR_2015_s_1 | 0.2049 | (0,4) | 0.051 | 0.249 | | 1 |
| F_fleet_3_YR_2016_s_1 | 0.1518 | (0,4) | 0.039 | 0.257 | | 1 |
| F_fleet_3_YR_2017_s_1 | 0.143 | (0,4) | 0.045 | 0.315 | | 1 |
| F_fleet_4_YR_1986_s_1 | 0.0067 | (0,4) | 0.001 | 0.149 | | 1 |

Table RW10 Continued. List of SS parameters for Gulf of Mexico Scamp.

| Label | Value | Range | SD | CV | Prior | Phase |
|-----------------------|---------|----------|-------|-------|-------|-------|
| F_fleet_4_YR_1987_s_1 | 0.0044 | (0,4) | 0.001 | 0.229 | | 1 |
| F_fleet_4_YR_1988_s_1 | 0.0034 | (0,4) | 0.001 | 0.296 | | 1 |
| F_fleet_4_YR_1989_s_1 | 0.0106 | (0,4) | 0.004 | 0.379 | | 1 |
| F_fleet_4_YR_1990_s_1 | 0.0046 | (0,4) | 0.002 | 0.435 | | 1 |
| F_fleet_4_YR_1991_s_1 | 0.0043 | (0,4) | 0.002 | 0.464 | | 1 |
| F_fleet_4_YR_1992_s_1 | 0.0033 | (0,4) | 0.001 | 0.302 | | 1 |
| F_fleet_4_YR_1993_s_1 | 0.0031 | (0,4) | 0.001 | 0.32 | | 1 |
| F_fleet_4_YR_1994_s_1 | 0.0019 | (0,4) | 0.001 | 0.525 | | 1 |
| F_fleet_4_YR_1995_s_1 | 0.0022 | (0,4) | 0.001 | 0.461 | | 1 |
| F_fleet_4_YR_1996_s_1 | 0.0012 | (0,4) | 0 | 0 | | 1 |
| F_fleet_4_YR_1997_s_1 | 0.0017 | (0,4) | 0.001 | 0.598 | | 1 |
| F_fleet_4_YR_1998_s_1 | 0.0017 | (0,4) | 0.001 | 0.577 | | 1 |
| F_fleet_4_YR_1999_s_1 | 0.0021 | (0,4) | 0.001 | 0.48 | | 1 |
| F_fleet_4_YR_2000_s_1 | 0.0022 | (0,4) | 0.001 | 0.458 | | 1 |
| F_fleet_4_YR_2001_s_1 | 0.0011 | (0,4) | 0 | 0 | | 1 |
| F_fleet_4_YR_2002_s_1 | 0.0012 | (0,4) | 0 | 0 | | 1 |
| F_fleet_4_YR_2003_s_1 | 0.0011 | (0,4) | 0 | 0 | | 1 |
| F_fleet_4_YR_2004_s_1 | 0.0019 | (0,4) | 0.001 | 0.523 | | 1 |
| F_fleet_4_YR_2005_s_1 | 0.0012 | (0,4) | 0 | 0 | | 1 |
| F_fleet_4_YR_2006_s_1 | 7e-04 | (0,4) | 0 | 0 | | 1 |
| F_fleet_4_YR_2007_s_1 | 9e-04 | (0,4) | 0 | 0 | | 1 |
| F_fleet_4_YR_2008_s_1 | 0.0015 | (0,4) | 0 | 0 | | 1 |
| F_fleet_4_YR_2009_s_1 | 0.0016 | (0,4) | 0 | 0 | | 1 |
| F_fleet_4_YR_2010_s_1 | 0.002 | (0,4) | 0.001 | 0.504 | | 1 |
| F_fleet_4_YR_2011_s_1 | 0.0019 | (0,4) | 0.001 | 0.533 | | 1 |
| F_fleet_4_YR_2012_s_1 | 0.0026 | (0,4) | 0.001 | 0.389 | | 1 |
| F_fleet_4_YR_2013_s_1 | 0.0034 | (0,4) | 0.001 | 0.291 | | 1 |
| F_fleet_4_YR_2014_s_1 | 0.0059 | (0,4) | 0.002 | 0.34 | | 1 |
| F_fleet_4_YR_2015_s_1 | 0.0083 | (0,4) | 0.002 | 0.242 | | 1 |
| F_fleet_4_YR_2016_s_1 | 0.0058 | (0,4) | 0.002 | 0.347 | | 1 |
| F_fleet_4_YR_2017_s_1 | 0.0052 | (0,4) | 0.002 | 0.383 | | 1 |
| LnQ_base_ComVL(1) | -7.3808 | (-25,25) | | | | -4 |
| Q_extraSD_ComVL(1) | 0.0599 | (0,0.5) | 0.046 | 0.768 | | 4 |

Table RW10 Continued. List of SS parameters for Gulf of Mexico Scamp.

| Label | Value | Range | SD | CV | Prior | Phase |
|--|---------|----------|-------|--------|-------|-------|
| LnQ_base_Headboat(4) | -6.4689 | (-25,25) | | | | -4 |
| Q_extraSD_Headboat(4) | 0.0394 | (0,0.5) | 0.03 | 0.762 | | 4 |
| LnQ_base_Combined_Video(5) | -7.4014 | (-25,25) | | | | -1 |
| Q_extraSD_Combined_Video(5) | 0.1318 | (0,0.5) | 0.046 | 0.349 | | 4 |
| LnQ_base_RFOP_Index(6) | -6.8707 | (-25,25) | | | | -1 |
| Q_extraSD_RFOP_Index(6) | 0.3049 | (0,0.5) | 0.094 | 0.308 | | 4 |
| Size_inflection_ComVL(1) | 42.2017 | (10,85) | 0.482 | 0.011 | | 2 |
| Size_95%width_ComVL(1) | 12.991 | (0,50) | 0.603 | 0.046 | | 2 |
| Retain_L_infl_ComVL(1) | 0 | (0,85) | | | | -3 |
| Retain_L_width_ComVL(1) | 1 | (0,20) | | | | -3 |
| Retain_L_asymptote_logit_ComVL(1) | 10 | (-10,10) | | | | -2 |
| Retain_L_maleoffset_ComVL(1) | 0 | (-1,2) | | | | -4 |
| DiscMort_L_infl_ComVL(1) | -5 | (-10,10) | | | | -2 |
| DiscMort_L_width_ComVL(1) | 1 | (-1,2) | | | | -4 |
| DiscMort_L_level_old_ComVL(1) | 0.47 | (-1,2) | | | | -2 |
| DiscMort_L_male_offset_ComVL(1) | 0 | (-1,2) | | | | -4 |
| Size_inflection_ComLL(2) | 49.6797 | (10,85) | 0.373 | 0.008 | | 2 |
| Size_95%width_ComLL(2) | 11.641 | (0,50) | 0.343 | 0.029 | | 2 |
| Retain_L_infl_ComLL(2) | 0 | (0,85) | | | | -3 |
| Retain_L_width_ComLL(2) | 1 | (0,20) | | | | -3 |
| Retain_L_asymptote_logit_ComLL(2) | 10 | (-10,10) | | | | -2 |
| Retain_L_maleoffset_ComLL(2) | 0 | (-1,2) | | | | -4 |
| DiscMort_L_infl_ComLL(2) | -5 | (-10,10) | | | | -2 |
| DiscMort_L_width_ComLL(2) | 1 | (-1,2) | | | | -4 |
| DiscMort_L_level_old_ComLL(2) | 0.68 | (-1,2) | | | | -2 |
| DiscMort_L_male_offset_ComLL(2) | 0 | (-1,2) | | | | -4 |
| Size_DbIN_peak_Charter_Private(3) | 31.0449 | (10,85) | 1.132 | 0.036 | | 2 |
| Size_DbIN_top_logit_Charter_Private(3) | -2.4876 | (-15,15) | 0.387 | -0.156 | | 3 |
| Size_DbIN_ascend_se_Charter_Private(3) | 2.4379 | (-15,15) | 0.606 | 0.249 | | 3 |
| Size_DbIN_descend_se_Charter_Private(3) | 4.1334 | (-15,15) | 0.571 | 0.138 | | 3 |
| Size_DbIN_start_logit_Charter_Private(3) | -5.8577 | (-15,15) | 1.273 | -0.217 | | 2 |
| Size_DbIN_end_logit_Charter_Private(3) | -0.2048 | (-15,15) | 0.192 | -0.937 | | 4 |
| Retain_L_infl_Charter_Private(3) | 31 | (10,85) | | | | -3 |

Table RW10 Continued. List of SS parameters for Gulf of Mexico Scamp.

| Label | Value | Range | SD | CV | Prior | Phase |
|---|---------|----------|---------|---------|-----------------|-------|
| Retain_L_width_Charter_Private(3) | 0.5 | (0,20) | | | | -3 |
| Retain_L_asymptote_logit_Charter_Private(3) | 10 | (-10,10) | | | | -2 |
| Retain_L_maleoffset_Charter_Private(3) | 0 | (-1,2) | | | | -4 |
| DiscMort_L_infl_Charter_Private(3) | -5 | (-10,10) | | | | -2 |
| DiscMort_L_width_Charter_Private(3) | 1 | (-1,2) | | | | -4 |
| DiscMort_L_level_old_Charter_Private(3) | 0.26 | (-1,2) | | | | -2 |
| DiscMort_L_male_offset_Charter_Private(3) | 0 | (-1,2) | | | | -4 |
| Size_DbIN_peak_Headboat(4) | 38.3516 | (10,85) | 1.364 | 0.036 | | 2 |
| Size_DbIN_top_logit_Headboat(4) | -2.7938 | (-15,15) | 0.27 | -0.097 | | 3 |
| Size_DbIN_ascend_se_Headboat(4) | 4.1041 | (-15,15) | 0.24 | 0.058 | | 3 |
| Size_DbIN_descend_se_Headboat(4) | -7.6684 | (-15,15) | 247.795 | -32.314 | | 3 |
| Size_DbIN_start_logit_Headboat(4) | -8.2087 | (-15,15) | 3.815 | -0.465 | | 2 |
| Size_DbIN_end_logit_Headboat(4) | -0.3072 | (-15,15) | 0.108 | -0.352 | | 4 |
| Retain_L_infl_Headboat(4) | 0 | (0,85) | | | | -3 |
| Retain_L_width_Headboat(4) | 1 | (0,20) | | | | -3 |
| Retain_L_asymptote_logit_Headboat(4) | 10 | (-10,10) | | | | -2 |
| Retain_L_maleoffset_Headboat(4) | 0 | (-1,2) | | | | -4 |
| DiscMort_L_infl_Headboat(4) | -5 | (-10,10) | | | | -2 |
| DiscMort_L_width_Headboat(4) | 1 | (-1,2) | | | | -4 |
| DiscMort_L_level_old_Headboat(4) | 0.26 | (-1,2) | | | | -2 |
| DiscMort_L_male_offset_Headboat(4) | 0 | (-1,2) | | | | -4 |
| Size_inflection_Combined_Video(5) | 28.1731 | (10,85) | 0.432 | 0.015 | | 2 |
| Size_95%width_Combined_Video(5) | 7.986 | (0,50) | 0.607 | 0.076 | | 2 |
| Size_inflection_RFOP_Index(6) | 37.5187 | (10,85) | 0.459 | 0.012 | | 2 |
| Size_95%width_RFOP_Index(6) | 9.4238 | (0,50) | 0.602 | 0.064 | | 2 |
| ln(DM_theta)_1 | 4.9791 | (-5,5) | | | Normal (0,1.81) | -6 |
| ln(DM_theta)_2 | 4.9957 | (-5,5) | | | Normal (0,1.81) | -6 |
| ln(DM_theta)_3 | 4.9225 | (-5,5) | | | Normal (0,1.81) | -6 |
| ln(DM_theta)_4 | 4.5175 | (-5,5) | 0.7 | 0.155 | Normal (0,1.81) | 6 |
| ln(DM_theta)_5 | 4.4013 | (-5,5) | 0.772 | 0.175 | Normal (0,1.81) | 6 |
| ln(DM_theta)_6 | -2.0422 | (-5,5) | 0.095 | -0.047 | Normal (0,1.81) | 6 |
| ln(DM_theta)_7 | 1.9895 | (-5,5) | 0.589 | 0.296 | Normal (0,1.81) | 6 |
| ln(DM_theta)_8 | 0.1795 | (-5,5) | 0.19 | 1.059 | Normal (0,1.81) | 6 |

Table RW10 Continued. List of SS parameters for Gulf of Mexico Scamp.

| Label | Value | Range | SD | CV | Prior | Phase |
|---|---------|----------|--------|-------|-----------------|-------|
| ln(DM_theta)_9 | 1.7121 | (-5,5) | 0.418 | 0.244 | Normal (0,1.81) | 6 |
| ln(DM_theta)_10 | 1.24 | (-5,5) | 0.336 | 0.271 | Normal (0,1.81) | 6 |
| Retain_L_infl_ComVL(1)_BLK1repl_1990 | 34.6729 | (10,85) | 1.08 | 0.031 | | 3 |
| Retain_L_infl_ComVL(1)_BLK1repl_1999 | 32.5081 | (10,85) | 0.86 | 0.026 | | 3 |
| Retain_L_infl_ComVL(1)_BLK1repl_2003 | 35.9354 | (10,85) | 0.378 | 0.011 | | 3 |
| Retain_L_infl_ComVL(1)_BLK1repl_2010 | 38.0328 | (10,85) | 0.269 | 0.007 | | 3 |
| Retain_L_width_ComVL(1)_BLK1repl_1990 | 4.1027 | (0,20) | 0.813 | 0.198 | | 3 |
| Retain_L_width_ComVL(1)_BLK1repl_1999 | 2.5003 | (0,20) | 0.956 | 0.382 | | 3 |
| Retain_L_width_ComVL(1)_BLK1repl_2003 | 1.3548 | (0,20) | 0.238 | 0.176 | | 3 |
| Retain_L_width_ComVL(1)_BLK1repl_2010 | 1.6199 | (0,20) | 0.235 | 0.145 | | 3 |
| Retain_L_asymptote_logit_ComVL(1)_BLK1repl_1990 | 10 | (-10,10) | | | | -3 |
| Retain_L_asymptote_logit_ComVL(1)_BLK1repl_1999 | 10 | (-10,10) | | | | -3 |
| Retain_L_asymptote_logit_ComVL(1)_BLK1repl_2003 | 10 | (-10,10) | | | | -3 |
| Retain_L_asymptote_logit_ComVL(1)_BLK1repl_2010 | 4.225 | (-10,10) | 0.315 | 0.075 | | 3 |
| Retain_L_infl_ComLL(2)_BLK1repl_1990 | 35.0985 | (10,85) | 2.299 | 0.066 | | 3 |
| Retain_L_infl_ComLL(2)_BLK1repl_1999 | 35.6922 | (10,85) | 0.875 | 0.025 | | 3 |
| Retain_L_infl_ComLL(2)_BLK1repl_2003 | 36.8563 | (10,85) | 0.645 | 0.018 | | 3 |
| Retain_L_infl_ComLL(2)_BLK1repl_2010 | 38.4093 | (10,85) | 0.595 | 0.015 | | 3 |
| Retain_L_width_ComLL(2)_BLK1repl_1990 | 3.5067 | (0,20) | 1.899 | 0.542 | | 3 |
| Retain_L_width_ComLL(2)_BLK1repl_1999 | 1.3125 | (0,20) | 0.714 | 0.544 | | 3 |
| Retain_L_width_ComLL(2)_BLK1repl_2003 | 1.7639 | (0,20) | 0.647 | 0.367 | | 3 |
| Retain_L_width_ComLL(2)_BLK1repl_2010 | 2.1323 | (0,20) | 0.314 | 0.147 | | 3 |
| Retain_L_asymptote_logit_ComLL(2)_BLK1repl_1990 | 10 | (-10,10) | | | | -3 |
| Retain_L_asymptote_logit_ComLL(2)_BLK1repl_1999 | 10 | (-10,10) | | | | -3 |
| Retain_L_asymptote_logit_ComLL(2)_BLK1repl_2003 | 10 | (-10,10) | | | | -3 |
| Retain_L_asymptote_logit_ComLL(2)_BLK1repl_2010 | 5.8884 | (-10,10) | 0.578 | 0.098 | | 3 |
| Retain_L_infl_Charter_Private(3)_BLK2repl_1990 | 41.635 | (10,85) | 0.976 | 0.023 | | 3 |
| Retain_L_infl_Charter_Private(3)_BLK2repl_1999 | 42.2927 | (10,85) | 0.887 | 0.021 | | 3 |
| Retain_L_infl_Charter_Private(3)_BLK2repl_2003 | 39.239 | (10,85) | 0.272 | 0.007 | | 3 |
| Retain_L_width_Charter_Private(3)_BLK2repl_1990 | 2.3359 | (0,20) | 0.577 | 0.247 | | 3 |
| Retain_L_width_Charter_Private(3)_BLK2repl_1999 | 2.7054 | (0,20) | 0.376 | 0.139 | | 3 |
| Retain_L_width_Charter_Private(3)_BLK2repl_2003 | 0.8836 | (0,20) | 0.121 | 0.137 | | 3 |
| Retain_L_asymptote_logit_Charter_Private(3)_BLK2repl_1990 | 9.4677 | (-10,10) | 13.661 | 1.443 | | 3 |

Table RW10 Continued. List of SS parameters for Gulf of Mexico Scamp.

| Label | Value | Range | SD | CV | Prior | Phase |
|---|---------|----------|--------|-------|-------|-------|
| Retain_L_asymptote_logit_Charter_Private(3)_BLK2repl_1999 | 9.0658 | (-10,10) | 21.486 | 2.37 | | 3 |
| Retain_L_asymptote_logit_Charter_Private(3)_BLK2repl_2003 | 3.5121 | (-10,10) | 0.783 | 0.223 | | 3 |
| Retain_L_infl_Headboat(4)_BLK2repl_1990 | 33.2189 | (10,85) | 1.092 | 0.033 | | 3 |
| Retain_L_infl_Headboat(4)_BLK2repl_1999 | 37.1605 | (10,85) | 0.902 | 0.024 | | 3 |
| Retain_L_infl_Headboat(4)_BLK2repl_2003 | 39.0896 | (10,85) | 0.155 | 0.004 | | 3 |
| Retain_L_width_Headboat(4)_BLK2repl_1990 | 2.4628 | (0,20) | 0.975 | 0.396 | | 3 |
| Retain_L_width_Headboat(4)_BLK2repl_1999 | 1.644 | (0,20) | 0.488 | 0.297 | | 3 |
| Retain_L_width_Headboat(4)_BLK2repl_2003 | 0.8058 | (0,20) | 0.085 | 0.105 | | 3 |
| Retain_L_asymptote_logit_Headboat(4)_BLK2repl_1990 | 1.2106 | (-10,10) | 0.51 | 0.421 | | 3 |
| Retain_L_asymptote_logit_Headboat(4)_BLK2repl_1999 | 0.7639 | (-10,10) | 0.434 | 0.568 | | 3 |
| Retain_L_asymptote_logit_Headboat(4)_BLK2repl_2003 | 4.0812 | (-10,10) | 0.59 | 0.145 | | 3 |

Table RW11. Estimates of annual exploitation rate (total biomass killed age 3+ / total biomass age 3+) by fleet and combined across all fleets (Total) for Gulf of Mexico Scamp, which was used as the proxy for annual fishing mortality rate.

| Year | Commercial Vertical Line | Commercial Longline | Recreational Charter Private | Recreational Headboat | Total |
|------|--------------------------|---------------------|------------------------------|-----------------------|-------|
| 1986 | 0.038 | 0.036 | 0.026 | 0.004 | 0.103 |
| 1987 | 0.039 | 0.032 | 0.026 | 0.002 | 0.100 |
| 1988 | 0.034 | 0.023 | 0.024 | 0.002 | 0.083 |
| 1989 | 0.037 | 0.028 | 0.012 | 0.006 | 0.082 |
| 1990 | 0.037 | 0.025 | 0.010 | 0.002 | 0.074 |
| 1991 | 0.046 | 0.031 | 0.014 | 0.002 | 0.092 |
| 1992 | 0.056 | 0.019 | 0.018 | 0.001 | 0.094 |
| 1993 | 0.054 | 0.025 | 0.027 | 0.001 | 0.107 |
| 1994 | 0.039 | 0.014 | 0.013 | 0.001 | 0.067 |
| 1995 | 0.042 | 0.014 | 0.004 | 0.001 | 0.062 |
| 1996 | 0.038 | 0.015 | 0.007 | 0.001 | 0.061 |
| 1997 | 0.046 | 0.017 | 0.010 | 0.001 | 0.074 |
| 1998 | 0.029 | 0.018 | 0.009 | 0.001 | 0.056 |
| 1999 | 0.035 | 0.017 | 0.018 | 0.001 | 0.070 |
| 2000 | 0.025 | 0.014 | 0.011 | 0.001 | 0.051 |

Table RW11 Continued. Estimates of annual exploitation rate (total biomass killed age 3+ / total biomass age 3+) by fleet and combined across all fleets (Total) for Gulf of Mexico Scamp, which was used as the proxy for annual fishing mortality rate.

| Year | Commercial Vertical Line | Commercial Longline | Recreational Charter Private | Recreational Headboat | Total |
|------|--------------------------|---------------------|------------------------------|-----------------------|-------|
| 2001 | 0.030 | 0.021 | 0.013 | 0.000 | 0.065 |
| 2002 | 0.033 | 0.021 | 0.012 | 0.000 | 0.066 |
| 2003 | 0.031 | 0.024 | 0.041 | 0.000 | 0.095 |
| 2004 | 0.028 | 0.025 | 0.046 | 0.001 | 0.100 |
| 2005 | 0.028 | 0.023 | 0.020 | 0.001 | 0.071 |
| 2006 | 0.021 | 0.014 | 0.028 | 0.000 | 0.064 |
| 2007 | 0.025 | 0.019 | 0.034 | 0.000 | 0.078 |
| 2008 | 0.023 | 0.023 | 0.046 | 0.001 | 0.092 |
| 2009 | 0.027 | 0.015 | 0.039 | 0.001 | 0.082 |
| 2010 | 0.016 | 0.011 | 0.038 | 0.001 | 0.066 |
| 2011 | 0.015 | 0.011 | 0.027 | 0.001 | 0.054 |
| 2012 | 0.029 | 0.017 | 0.066 | 0.001 | 0.113 |
| 2013 | 0.029 | 0.021 | 0.045 | 0.001 | 0.096 |
| 2014 | 0.023 | 0.013 | 0.077 | 0.002 | 0.116 |
| 2015 | 0.024 | 0.020 | 0.096 | 0.003 | 0.143 |
| 2016 | 0.040 | 0.040 | 0.071 | 0.002 | 0.153 |
| 2017 | 0.027 | 0.024 | 0.067 | 0.002 | 0.120 |

Table RW12. Expected biomass (metric tons) for all Scamp and exploited Scamp (3+ years), spawning stock biomass (SSB, metric tons), exploited numbers (3+years, 1,000s of fish), age-0 recruits (1,000s of fish), and SSB ratio (SSB/SSB₀) where SSB₀ = 3,816 metric tons for Gulf of Mexico Scamp.

| Year | Biomass (all) | Biomass (exploited) | SSB | Abundance | Recruits | SSB ratio |
|------|---------------|---------------------|-------|-----------|----------|-----------|
| 1986 | 2,348 | 2,198 | 2,016 | 1,923.33 | 558.82 | 0.53 |
| 1987 | 2,271 | 2,154 | 1,972 | 1,895.18 | 936.72 | 0.52 |
| 1988 | 2,182 | 2,120 | 1,939 | 1,876.97 | 921.01 | 0.51 |
| 1989 | 2,108 | 2,022 | 1,904 | 1,566.88 | 1,805.17 | 0.50 |
| 1990 | 2,052 | 1,942 | 1,840 | 1,453.08 | 1,998.64 | 0.48 |
| 1991 | 2,042 | 1,873 | 1,772 | 1,375.12 | 1,674.72 | 0.46 |
| 1992 | 2,024 | 1,853 | 1,701 | 1,552.48 | 1,543.34 | 0.45 |

Table RW12 Continued. Expected biomass (metric tons) for all Scamp and exploited Scamp (3+ years), spawning stock biomass (SSB, metric tons), exploited numbers (3+years, 1,000s of fish), age-0 recruits (1,000s of fish), and SSB ratio (SSB/SSB₀) where SSB₀ = 3,816 metric tons for Gulf of Mexico Scamp.

| Year | Biomass (all) | Biomass (exploited) | SSB | Abundance | Recruits | SSB ratio |
|------|---------------|---------------------|-------|-----------|----------|-----------|
| 1993 | 2,017 | 1,869 | 1,675 | 1,733.06 | 1,974.77 | 0.44 |
| 1994 | 2,008 | 1,856 | 1,662 | 1,762.02 | 1,973.62 | 0.44 |
| 1995 | 2,089 | 1,911 | 1,729 | 1,783.78 | 1,511.47 | 0.45 |
| 1996 | 2,178 | 2,012 | 1,812 | 1,932.20 | 2,319.28 | 0.48 |
| 1997 | 2,278 | 2,118 | 1,906 | 2,044.01 | 1,204.31 | 0.50 |
| 1998 | 2,333 | 2,156 | 1,965 | 1,984.67 | 1,555.90 | 0.52 |
| 1999 | 2,411 | 2,289 | 2,067 | 2,189.78 | 3,708.07 | 0.54 |
| 2000 | 2,497 | 2,294 | 2,114 | 2,007.63 | 1,489.11 | 0.55 |
| 2001 | 2,620 | 2,349 | 2,178 | 1,997.24 | 3,138.25 | 0.57 |
| 2002 | 2,742 | 2,559 | 2,264 | 2,587.20 | 2,480.82 | 0.59 |
| 2003 | 2,863 | 2,600 | 2,356 | 2,395.22 | 2,074.27 | 0.62 |
| 2004 | 2,903 | 2,692 | 2,405 | 2,674.83 | 1,205.03 | 0.63 |
| 2005 | 2,889 | 2,727 | 2,442 | 2,683.13 | 1,384.26 | 0.64 |
| 2006 | 2,916 | 2,801 | 2,545 | 2,629.17 | 2,045.50 | 0.67 |
| 2007 | 2,939 | 2,794 | 2,606 | 2,346.91 | 1,799.97 | 0.68 |
| 2008 | 2,906 | 2,730 | 2,569 | 2,168.93 | 942.92 | 0.67 |
| 2009 | 2,808 | 2,671 | 2,480 | 2,201.19 | 997.90 | 0.65 |
| 2010 | 2,711 | 2,624 | 2,426 | 2,167.95 | 924.67 | 0.64 |
| 2011 | 2,628 | 2,540 | 2,390 | 1,917.67 | 988.18 | 0.63 |
| 2012 | 2,560 | 2,475 | 2,352 | 1,766.10 | 647.45 | 0.62 |
| 2013 | 2,326 | 2,247 | 2,139 | 1,554.57 | 776.96 | 0.56 |
| 2014 | 2,146 | 2,083 | 1,977 | 1,441.93 | 1,328.66 | 0.52 |
| 2015 | 1,945 | 1,858 | 1,771 | 1,232.06 | 1,475.68 | 0.46 |
| 2016 | 1,742 | 1,618 | 1,536 | 1,091.70 | 1,429.54 | 0.40 |
| 2017 | 1,591 | 1,459 | 1,345 | 1,150.78 | 1,383.32 | 0.35 |

Table RW13. Expected female and male spawning stock biomass (SSB, metric tons), exploitable biomass (3+ years, metric tons), exploitable abundance (3+ years, 1,000s of fish), and the expected sex ratio (exploitable male:female) for Gulf of Mexico Scamp.

| Year | SSB (female) | SSB (male) | Biomass (female) | Biomass (male) | Abundance (female) | Abundance (male) | Sex ratio |
|------|-----------------|---------------|---------------------|-------------------|-----------------------|---------------------|--------------|
| 1986 | 1,382 | 633 | 1,565 | 633 | 1,677.81 | 245.52 | 14.6 |
| 1987 | 1,355 | 617 | 1,536 | 617 | 1,655.50 | 239.68 | 14.5 |
| 1988 | 1,334 | 605 | 1,515 | 605 | 1,641.89 | 235.08 | 14.3 |
| 1989 | 1,298 | 606 | 1,416 | 606 | 1,331.53 | 235.35 | 17.7 |
| 1990 | 1,235 | 605 | 1,337 | 605 | 1,220.94 | 232.14 | 19.0 |
| 1991 | 1,165 | 606 | 1,267 | 606 | 1,145.97 | 229.16 | 20.0 |
| 1992 | 1,108 | 592 | 1,261 | 592 | 1,332.22 | 220.26 | 16.5 |
| 1993 | 1,101 | 574 | 1,295 | 574 | 1,520.20 | 212.86 | 14.0 |
| 1994 | 1,117 | 545 | 1,311 | 545 | 1,557.29 | 204.73 | 13.1 |
| 1995 | 1,183 | 546 | 1,364 | 546 | 1,575.49 | 208.28 | 13.2 |
| 1996 | 1,260 | 551 | 1,460 | 551 | 1,718.58 | 213.62 | 12.4 |
| 1997 | 1,344 | 561 | 1,556 | 561 | 1,822.79 | 221.22 | 12.1 |
| 1998 | 1,399 | 566 | 1,590 | 566 | 1,757.81 | 226.86 | 12.9 |
| 1999 | 1,479 | 587 | 1,702 | 587 | 1,952.79 | 236.99 | 12.1 |
| 2000 | 1,510 | 603 | 1,691 | 603 | 1,762.24 | 245.39 | 13.9 |
| 2001 | 1,542 | 636 | 1,713 | 636 | 1,740.20 | 257.04 | 14.8 |
| 2002 | 1,605 | 659 | 1,900 | 659 | 2,323.67 | 263.54 | 11.3 |
| 2003 | 1,675 | 680 | 1,919 | 680 | 2,120.07 | 275.15 | 13.0 |
| 2004 | 1,723 | 682 | 2,010 | 682 | 2,399.10 | 275.73 | 11.5 |
| 2005 | 1,762 | 680 | 2,047 | 680 | 2,405.49 | 277.64 | 11.5 |
| 2006 | 1,843 | 702 | 2,099 | 702 | 2,340.05 | 289.12 | 12.4 |
| 2007 | 1,869 | 736 | 2,057 | 736 | 2,044.15 | 302.76 | 14.8 |
| 2008 | 1,810 | 758 | 1,971 | 758 | 1,861.85 | 307.08 | 16.5 |
| 2009 | 1,714 | 765 | 1,905 | 765 | 1,897.72 | 303.47 | 16.0 |
| 2010 | 1,648 | 777 | 1,847 | 777 | 1,865.35 | 302.60 | 16.2 |
| 2011 | 1,590 | 799 | 1,740 | 799 | 1,611.75 | 305.92 | 19.0 |
| 2012 | 1,524 | 827 | 1,647 | 827 | 1,456.67 | 309.43 | 21.2 |

Table RW13 Continued. Expected female and male spawning stock biomass (SSB, metric tons), exploitable biomass (3+ years, metric tons), exploitable abundance (3+ years, 1,000s of fish), and the expected sex ratio (exploitable male:female) for Gulf of Mexico Scamp.

| Year | SSB (female) | SSB (male) | Biomass (female) | Biomass (male) | Abundance (female) | Abundance (male) | Sex ratio |
|------|-----------------|---------------|---------------------|-------------------|-----------------------|---------------------|--------------|
| 2013 | 1,346 | 793 | 1,453 | 793 | 1,265.01 | 289.56 | 22.9 |
| 2014 | 1,210 | 767 | 1,316 | 767 | 1,168.26 | 273.67 | 23.4 |
| 2015 | 1,051 | 719 | 1,138 | 719 | 980.92 | 251.13 | 25.6 |
| 2016 | 888 | 647 | 970 | 647 | 870.45 | 221.25 | 25.4 |
| 2017 | 779 | 566 | 892 | 566 | 959.53 | 191.25 | 19.9 |

Table RW14A. Expected numbers-at-age (1,000s of fish) at the beginning of the year (January 1st) for female Scamp in the Gulf of Mexico.

| Year | 0 | 1 | 2 | 3 | 4 | 5 | 6 | 7 |
|------|-----------|-----------|-----------|-----------|---------|---------|---------|---------|
| 1986 | 558.822 | 969.799 | 652.776 | 471.461 | 343.964 | 252.001 | 184.041 | 133.219 |
| 1987 | 936.725 | 325.707 | 652.722 | 470.469 | 340.399 | 247.706 | 180.344 | 130.370 |
| 1988 | 921.014 | 545.966 | 219.218 | 470.505 | 339.881 | 245.411 | 177.534 | 127.990 |
| 1989 | 1,805.170 | 536.811 | 367.486 | 158.139 | 341.136 | 246.689 | 177.600 | 127.601 |
| 1990 | 1,998.640 | 1,052.150 | 361.312 | 265.389 | 115.523 | 250.214 | 180.312 | 128.689 |
| 1991 | 1,674.720 | 1,164.920 | 708.324 | 261.518 | 196.056 | 86.129 | 185.650 | 132.231 |
| 1992 | 1,543.340 | 976.113 | 784.206 | 512.356 | 192.719 | 145.385 | 63.313 | 134.383 |
| 1993 | 1,974.770 | 899.531 | 657.068 | 566.796 | 376.481 | 142.110 | 105.988 | 45.398 |
| 1994 | 1,973.620 | 1,150.980 | 605.498 | 474.316 | 414.608 | 275.363 | 102.325 | 74.800 |
| 1995 | 1,511.470 | 1,150.330 | 774.836 | 438.118 | 350.074 | 308.630 | 203.857 | 74.882 |
| 1996 | 2,319.280 | 880.976 | 774.408 | 561.223 | 324.528 | 262.091 | 230.206 | 150.388 |
| 1997 | 1,204.310 | 1,351.810 | 593.084 | 560.775 | 415.422 | 242.801 | 195.386 | 169.783 |
| 1998 | 1,555.900 | 701.941 | 910.014 | 429.230 | 414.151 | 309.233 | 179.454 | 142.414 |
| 1999 | 3,708.070 | 906.870 | 472.572 | 658.963 | 317.742 | 310.198 | 231.160 | 132.925 |
| 2000 | 1,489.110 | 2,161.240 | 610.511 | 341.733 | 485.228 | 235.699 | 228.722 | 168.475 |
| 2001 | 3,138.250 | 867.937 | 1,455.060 | 442.011 | 252.805 | 363.282 | 176.344 | 169.903 |
| 2002 | 2,480.820 | 1,829.140 | 584.323 | 1,053.070 | 326.510 | 188.653 | 270.175 | 129.822 |
| 2003 | 2,074.270 | 1,445.950 | 1,231.410 | 422.883 | 777.713 | 243.395 | 139.988 | 198.219 |
| 2004 | 1,205.030 | 1,208.950 | 973.392 | 888.530 | 309.073 | 566.839 | 174.379 | 98.732 |
| 2005 | 1,384.260 | 702.320 | 813.835 | 701.899 | 647.883 | 224.237 | 403.327 | 122.016 |
| 2006 | 2,045.500 | 806.815 | 472.818 | 588.715 | 517.702 | 480.828 | 165.039 | 293.250 |
| 2007 | 1,799.970 | 1,192.200 | 543.176 | 341.776 | 433.183 | 382.965 | 352.983 | 120.076 |
| 2008 | 942.922 | 1,049.090 | 802.611 | 392.370 | 250.848 | 318.677 | 278.593 | 253.833 |
| 2009 | 997.903 | 549.561 | 706.252 | 578.966 | 286.545 | 182.766 | 228.555 | 197.171 |
| 2010 | 924.673 | 581.610 | 369.967 | 509.764 | 423.717 | 209.628 | 131.921 | 163.065 |
| 2011 | 988.181 | 538.929 | 391.560 | 267.105 | 373.560 | 311.260 | 152.493 | 95.192 |
| 2012 | 647.451 | 575.954 | 362.838 | 283.099 | 196.747 | 277.226 | 229.905 | 111.967 |
| 2013 | 776.956 | 377.339 | 387.706 | 261.003 | 204.714 | 140.598 | 193.174 | 157.579 |
| 2014 | 1,328.660 | 452.830 | 254.020 | 279.586 | 190.420 | 148.830 | 100.463 | 136.118 |
| 2015 | 1,475.680 | 774.336 | 304.821 | 182.426 | 200.981 | 134.573 | 102.145 | 67.837 |
| 2016 | 1,429.540 | 859.990 | 521.210 | 218.321 | 129.863 | 139.273 | 89.652 | 66.638 |
| 2017 | 1,383.320 | 833.132 | 578.859 | 374.368 | 156.971 | 91.549 | 94.746 | 59.459 |

Table RW14A Continued. Expected numbers-at-age (1,000s of fish) at the beginning of the year (January 1st) for female Scamp in the Gulf of Mexico.

| Year | 8 | 9 | 10 | 11 | 12 | 13 | 14 | 15 |
|------|---------|---------|---------|--------|--------|--------|--------|--------|
| 1986 | 95.213 | 66.993 | 46.287 | 31.319 | 20.688 | 13.297 | 8.284 | 4.981 |
| 1987 | 93.094 | 65.446 | 45.181 | 30.549 | 20.168 | 12.956 | 8.068 | 4.850 |
| 1988 | 91.318 | 64.175 | 44.287 | 29.933 | 19.753 | 12.685 | 7.898 | 4.747 |
| 1989 | 91.047 | 64.084 | 44.294 | 29.970 | 19.791 | 12.715 | 7.918 | 4.760 |
| 1990 | 91.308 | 64.140 | 44.328 | 30.002 | 19.816 | 12.732 | 7.928 | 4.766 |
| 1991 | 92.995 | 64.884 | 44.731 | 30.267 | 19.997 | 12.851 | 8.003 | 4.811 |
| 1992 | 94.040 | 64.896 | 44.369 | 29.915 | 19.744 | 12.685 | 7.898 | 4.746 |
| 1993 | 94.708 | 65.108 | 44.084 | 29.510 | 19.425 | 12.476 | 7.770 | 4.671 |
| 1994 | 31.417 | 64.288 | 43.317 | 28.695 | 18.743 | 12.001 | 7.470 | 4.490 |
| 1995 | 53.990 | 22.329 | 44.898 | 29.651 | 19.190 | 12.204 | 7.578 | 4.554 |
| 1996 | 54.459 | 38.628 | 15.685 | 30.890 | 19.920 | 12.547 | 7.736 | 4.638 |
| 1997 | 109.389 | 38.985 | 27.158 | 10.803 | 20.780 | 13.043 | 7.966 | 4.742 |
| 1998 | 121.759 | 77.078 | 26.948 | 18.377 | 7.135 | 13.354 | 8.125 | 4.790 |
| 1999 | 104.163 | 87.716 | 54.562 | 18.694 | 12.452 | 4.707 | 8.541 | 5.018 |
| 2000 | 95.573 | 73.759 | 61.046 | 37.221 | 12.460 | 8.081 | 2.962 | 5.191 |
| 2001 | 123.837 | 69.321 | 52.644 | 42.744 | 25.478 | 8.307 | 5.226 | 1.850 |
| 2002 | 123.436 | 88.587 | 48.717 | 36.251 | 28.749 | 16.680 | 5.273 | 3.203 |
| 2003 | 93.900 | 87.843 | 61.900 | 33.342 | 24.227 | 18.697 | 10.517 | 3.210 |
| 2004 | 137.993 | 64.494 | 59.389 | 41.067 | 21.628 | 15.308 | 11.461 | 6.226 |
| 2005 | 68.178 | 94.021 | 43.259 | 39.093 | 26.432 | 13.559 | 9.310 | 6.732 |
| 2006 | 87.531 | 48.171 | 65.276 | 29.431 | 25.979 | 17.097 | 8.504 | 5.637 |
| 2007 | 211.444 | 62.421 | 33.871 | 45.095 | 19.897 | 17.119 | 10.935 | 5.255 |
| 2008 | 85.435 | 148.636 | 43.233 | 23.035 | 30.000 | 12.898 | 10.768 | 6.645 |
| 2009 | 177.790 | 59.170 | 101.503 | 29.007 | 15.125 | 19.199 | 8.011 | 6.462 |
| 2010 | 139.376 | 124.378 | 40.845 | 68.884 | 19.273 | 9.799 | 12.075 | 4.869 |
| 2011 | 116.925 | 99.130 | 87.434 | 28.262 | 46.704 | 12.750 | 6.296 | 7.500 |
| 2012 | 69.451 | 84.551 | 70.793 | 61.420 | 19.445 | 31.342 | 8.308 | 3.965 |
| 2013 | 76.060 | 46.788 | 56.325 | 46.441 | 39.497 | 12.203 | 19.107 | 4.896 |
| 2014 | 109.906 | 52.482 | 31.850 | 37.690 | 30.423 | 25.226 | 7.566 | 11.447 |
| 2015 | 91.344 | 73.372 | 34.735 | 20.799 | 24.161 | 19.051 | 15.357 | 4.455 |
| 2016 | 43.952 | 58.917 | 46.959 | 21.950 | 12.909 | 14.653 | 11.234 | 8.760 |
| 2017 | 43.506 | 28.311 | 37.381 | 29.254 | 13.375 | 7.664 | 8.440 | 6.250 |

Table RW14A Continued. Expected numbers-at-age (1,000s of fish) at the beginning of the year (January 1st) for female Scamp in the Gulf of Mexico.

| Year | 16 | 17 | 18 | 19 | 20+ |
|------|-------|-------|-------|-------|-------|
| 1986 | 2.879 | 1.591 | 0.837 | 0.417 | 0.336 |
| 1987 | 2.803 | 1.549 | 0.815 | 0.406 | 0.327 |
| 1988 | 2.742 | 1.515 | 0.797 | 0.397 | 0.320 |
| 1989 | 2.750 | 1.520 | 0.799 | 0.398 | 0.321 |
| 1990 | 2.753 | 1.521 | 0.800 | 0.398 | 0.321 |
| 1991 | 2.779 | 1.536 | 0.808 | 0.402 | 0.324 |
| 1992 | 2.741 | 1.514 | 0.796 | 0.396 | 0.319 |
| 1993 | 2.698 | 1.490 | 0.784 | 0.390 | 0.314 |
| 1994 | 2.594 | 1.433 | 0.753 | 0.375 | 0.302 |
| 1995 | 2.632 | 1.455 | 0.765 | 0.381 | 0.307 |
| 1996 | 2.679 | 1.481 | 0.779 | 0.388 | 0.313 |
| 1997 | 2.733 | 1.510 | 0.795 | 0.396 | 0.319 |
| 1998 | 2.740 | 1.510 | 0.794 | 0.396 | 0.319 |
| 1999 | 2.843 | 1.556 | 0.816 | 0.407 | 0.328 |
| 2000 | 2.931 | 1.589 | 0.828 | 0.411 | 0.332 |
| 2001 | 3.118 | 1.685 | 0.870 | 0.429 | 0.345 |
| 2002 | 1.090 | 1.757 | 0.904 | 0.442 | 0.352 |
| 2003 | 1.874 | 0.610 | 0.936 | 0.456 | 0.359 |
| 2004 | 1.827 | 1.021 | 0.316 | 0.459 | 0.359 |
| 2005 | 3.516 | 0.987 | 0.525 | 0.154 | 0.358 |
| 2006 | 3.918 | 1.958 | 0.523 | 0.263 | 0.224 |
| 2007 | 3.350 | 2.229 | 1.060 | 0.268 | 0.221 |
| 2008 | 3.071 | 1.873 | 1.186 | 0.534 | 0.220 |
| 2009 | 3.835 | 1.696 | 0.985 | 0.591 | 0.342 |
| 2010 | 3.778 | 2.146 | 0.904 | 0.497 | 0.428 |
| 2011 | 2.910 | 2.161 | 1.169 | 0.466 | 0.430 |
| 2012 | 4.544 | 1.687 | 1.193 | 0.611 | 0.419 |
| 2013 | 2.249 | 2.467 | 0.872 | 0.584 | 0.454 |
| 2014 | 2.821 | 1.240 | 1.295 | 0.434 | 0.464 |
| 2015 | 6.488 | 1.531 | 0.641 | 0.634 | 0.392 |
| 2016 | 2.446 | 3.412 | 0.767 | 0.304 | 0.439 |
| 2017 | 4.686 | 1.252 | 1.662 | 0.354 | 0.303 |

Table RW14B. Expected biomass-at-age (metric tons) at the beginning of the year (January 1st) for female Scamp in the Gulf of Mexico.

| Year | 0 | 1 | 2 | 3 | 4 | 5 | 6 | 7 |
|------|-------|---------|---------|---------|---------|---------|---------|---------|
| 1986 | 0.641 | 48.199 | 100.460 | 150.709 | 185.149 | 200.838 | 199.197 | 184.139 |
| 1987 | 1.075 | 16.188 | 100.452 | 150.391 | 183.230 | 197.415 | 195.196 | 180.200 |
| 1988 | 1.057 | 27.135 | 33.737 | 150.403 | 182.952 | 195.586 | 192.155 | 176.910 |
| 1989 | 2.072 | 26.680 | 56.555 | 50.551 | 183.627 | 196.605 | 192.227 | 176.372 |
| 1990 | 2.294 | 52.292 | 55.605 | 84.835 | 62.184 | 199.413 | 195.162 | 177.877 |
| 1991 | 1.922 | 57.897 | 109.009 | 83.598 | 105.533 | 68.642 | 200.939 | 182.773 |
| 1992 | 1.771 | 48.513 | 120.687 | 163.781 | 103.737 | 115.868 | 68.528 | 185.747 |
| 1993 | 2.267 | 44.707 | 101.121 | 181.184 | 202.653 | 113.258 | 114.717 | 62.750 |
| 1994 | 2.265 | 57.204 | 93.184 | 151.621 | 223.176 | 219.457 | 110.752 | 103.390 |
| 1995 | 1.735 | 57.172 | 119.245 | 140.050 | 188.438 | 245.970 | 220.645 | 103.504 |
| 1996 | 2.662 | 43.785 | 119.179 | 179.402 | 174.687 | 208.879 | 249.165 | 207.870 |
| 1997 | 1.382 | 67.185 | 91.274 | 179.259 | 223.614 | 193.506 | 211.476 | 234.678 |
| 1998 | 1.786 | 34.887 | 140.049 | 137.209 | 222.929 | 246.450 | 194.233 | 196.847 |
| 1999 | 4.256 | 45.072 | 72.728 | 210.646 | 171.035 | 247.220 | 250.197 | 183.731 |
| 2000 | 1.709 | 107.414 | 93.956 | 109.239 | 261.189 | 187.846 | 247.558 | 232.870 |
| 2001 | 3.602 | 43.137 | 223.929 | 141.295 | 136.080 | 289.526 | 190.867 | 234.844 |
| 2002 | 2.847 | 90.908 | 89.926 | 336.628 | 175.754 | 150.351 | 292.426 | 179.443 |
| 2003 | 2.381 | 71.864 | 189.511 | 135.180 | 418.628 | 193.979 | 151.517 | 273.983 |
| 2004 | 1.383 | 60.085 | 149.802 | 284.030 | 166.368 | 451.756 | 188.740 | 136.469 |
| 2005 | 1.589 | 34.905 | 125.247 | 224.371 | 348.743 | 178.711 | 436.543 | 168.653 |
| 2006 | 2.348 | 40.099 | 72.765 | 188.190 | 278.669 | 383.207 | 178.631 | 405.336 |
| 2007 | 2.066 | 59.253 | 83.593 | 109.253 | 233.174 | 305.212 | 382.053 | 165.972 |
| 2008 | 1.082 | 52.140 | 123.520 | 125.426 | 135.027 | 253.977 | 301.536 | 350.853 |
| 2009 | 1.145 | 27.313 | 108.690 | 185.074 | 154.242 | 145.660 | 247.378 | 272.533 |
| 2010 | 1.061 | 28.906 | 56.937 | 162.953 | 228.079 | 167.068 | 142.785 | 225.392 |
| 2011 | 1.134 | 26.785 | 60.260 | 85.384 | 201.080 | 248.065 | 165.052 | 131.576 |
| 2012 | 0.743 | 28.625 | 55.840 | 90.496 | 105.905 | 220.941 | 248.839 | 154.762 |
| 2013 | 0.892 | 18.754 | 59.667 | 83.433 | 110.194 | 112.052 | 209.082 | 217.809 |
| 2014 | 1.525 | 22.506 | 39.093 | 89.373 | 102.499 | 118.613 | 108.737 | 188.146 |
| 2015 | 1.694 | 38.485 | 46.911 | 58.315 | 108.184 | 107.251 | 110.557 | 93.766 |
| 2016 | 1.641 | 42.742 | 80.213 | 69.789 | 69.903 | 110.997 | 97.036 | 92.108 |
| 2017 | 1.588 | 41.407 | 89.085 | 119.671 | 84.494 | 72.962 | 102.549 | 82.186 |

Table RW14B Continued. Expected biomass-at-age (metric tons) at the beginning of the year (January 1st) for female Scamp in the Gulf of Mexico.

| Year | 8 | 9 | 10 | 11 | 12 | 13 | 14 | 15 |
|------|---------|---------|---------|---------|---------|--------|--------|--------|
| 1986 | 160.560 | 133.086 | 105.389 | 79.958 | 58.179 | 40.593 | 27.124 | 17.319 |
| 1987 | 156.986 | 130.012 | 102.871 | 77.991 | 56.715 | 39.553 | 26.419 | 16.863 |
| 1988 | 153.991 | 127.487 | 100.836 | 76.418 | 55.549 | 38.726 | 25.859 | 16.503 |
| 1989 | 153.534 | 127.306 | 100.850 | 76.513 | 55.656 | 38.817 | 25.927 | 16.549 |
| 1990 | 153.974 | 127.418 | 100.929 | 76.596 | 55.727 | 38.868 | 25.959 | 16.568 |
| 1991 | 156.819 | 128.896 | 101.847 | 77.273 | 56.236 | 39.232 | 26.205 | 16.725 |
| 1992 | 158.581 | 128.919 | 101.021 | 76.373 | 55.523 | 38.724 | 25.861 | 16.502 |
| 1993 | 159.708 | 129.340 | 100.372 | 75.339 | 54.627 | 38.086 | 25.442 | 16.238 |
| 1994 | 52.979 | 127.711 | 98.626 | 73.258 | 52.709 | 36.637 | 24.458 | 15.610 |
| 1995 | 91.045 | 44.357 | 102.226 | 75.698 | 53.965 | 37.255 | 24.812 | 15.834 |
| 1996 | 91.835 | 76.737 | 35.712 | 78.863 | 56.020 | 38.305 | 25.330 | 16.124 |
| 1997 | 184.464 | 77.446 | 61.835 | 27.581 | 58.437 | 39.818 | 26.082 | 16.486 |
| 1998 | 205.325 | 153.119 | 61.357 | 46.916 | 20.066 | 40.766 | 26.603 | 16.652 |
| 1999 | 175.651 | 174.253 | 124.229 | 47.725 | 35.018 | 14.369 | 27.966 | 17.444 |
| 2000 | 161.166 | 146.526 | 138.992 | 95.025 | 35.039 | 24.669 | 9.699 | 18.046 |
| 2001 | 208.829 | 137.709 | 119.864 | 109.124 | 71.648 | 25.360 | 17.113 | 6.433 |
| 2002 | 208.153 | 175.982 | 110.921 | 92.549 | 80.846 | 50.921 | 17.266 | 11.136 |
| 2003 | 158.346 | 174.505 | 140.938 | 85.122 | 68.130 | 57.081 | 34.436 | 11.160 |
| 2004 | 232.701 | 128.120 | 135.220 | 104.844 | 60.822 | 46.732 | 37.526 | 21.646 |
| 2005 | 114.970 | 186.777 | 98.494 | 99.803 | 74.330 | 41.395 | 30.483 | 23.404 |
| 2006 | 147.606 | 95.693 | 148.624 | 75.138 | 73.057 | 52.195 | 27.845 | 19.598 |
| 2007 | 356.561 | 124.003 | 77.120 | 115.127 | 55.955 | 52.262 | 35.805 | 18.270 |
| 2008 | 144.070 | 295.272 | 98.434 | 58.808 | 84.365 | 39.376 | 35.259 | 23.101 |
| 2009 | 299.810 | 117.545 | 231.108 | 74.055 | 42.534 | 58.612 | 26.232 | 22.466 |
| 2010 | 235.033 | 247.083 | 92.999 | 175.859 | 54.200 | 29.914 | 39.538 | 16.928 |
| 2011 | 197.172 | 196.927 | 199.076 | 72.152 | 131.341 | 38.922 | 20.614 | 26.074 |
| 2012 | 117.116 | 167.965 | 161.186 | 156.804 | 54.683 | 95.681 | 27.202 | 13.785 |
| 2013 | 128.261 | 92.947 | 128.245 | 118.565 | 111.074 | 37.254 | 62.561 | 17.023 |
| 2014 | 185.337 | 104.257 | 72.518 | 96.222 | 85.554 | 77.011 | 24.773 | 39.796 |
| 2015 | 154.035 | 145.756 | 79.086 | 53.100 | 67.945 | 58.161 | 50.282 | 15.489 |
| 2016 | 74.117 | 117.041 | 106.919 | 56.038 | 36.301 | 44.733 | 36.783 | 30.456 |
| 2017 | 73.364 | 56.241 | 85.111 | 74.686 | 37.614 | 23.396 | 27.636 | 21.730 |

Table RW14B Continued. Expected biomass-at-age (metric tons) at the beginning of the year (January 1st) for female Scamp in the Gulf of Mexico.

| Year | 16 | 17 | 18 | 19 | 20+ |
|------|--------|--------|-------|-------|-------|
| 1986 | 10.538 | 6.089 | 3.328 | 1.713 | 1.444 |
| 1987 | 10.258 | 5.926 | 3.239 | 1.667 | 1.404 |
| 1988 | 10.037 | 5.798 | 3.168 | 1.630 | 1.374 |
| 1989 | 10.066 | 5.815 | 3.178 | 1.635 | 1.378 |
| 1990 | 10.077 | 5.821 | 3.181 | 1.637 | 1.379 |
| 1991 | 10.172 | 5.875 | 3.210 | 1.652 | 1.392 |
| 1992 | 10.034 | 5.794 | 3.166 | 1.629 | 1.372 |
| 1993 | 9.875 | 5.703 | 3.115 | 1.603 | 1.350 |
| 1994 | 9.494 | 5.482 | 2.995 | 1.541 | 1.298 |
| 1995 | 9.634 | 5.565 | 3.041 | 1.564 | 1.318 |
| 1996 | 9.807 | 5.667 | 3.097 | 1.594 | 1.342 |
| 1997 | 10.002 | 5.778 | 3.159 | 1.626 | 1.370 |
| 1998 | 10.030 | 5.779 | 3.158 | 1.626 | 1.370 |
| 1999 | 10.408 | 5.955 | 3.246 | 1.671 | 1.408 |
| 2000 | 10.730 | 6.081 | 3.292 | 1.690 | 1.425 |
| 2001 | 11.412 | 6.446 | 3.457 | 1.762 | 1.482 |
| 2002 | 3.990 | 6.723 | 3.593 | 1.814 | 1.513 |
| 2003 | 6.860 | 2.334 | 3.721 | 1.873 | 1.542 |
| 2004 | 6.688 | 3.905 | 1.257 | 1.888 | 1.541 |
| 2005 | 12.870 | 3.777 | 2.087 | 0.633 | 1.536 |
| 2006 | 14.341 | 7.490 | 2.080 | 1.082 | 0.970 |
| 2007 | 12.263 | 8.527 | 4.214 | 1.102 | 0.952 |
| 2008 | 11.240 | 7.168 | 4.716 | 2.196 | 0.945 |
| 2009 | 14.036 | 6.489 | 3.916 | 2.427 | 1.461 |
| 2010 | 13.828 | 8.210 | 3.592 | 2.042 | 1.831 |
| 2011 | 10.650 | 8.268 | 4.646 | 1.916 | 1.845 |
| 2012 | 16.632 | 6.456 | 4.744 | 2.512 | 1.803 |
| 2013 | 8.230 | 9.439 | 3.468 | 2.401 | 1.948 |
| 2014 | 10.327 | 4.745 | 5.149 | 1.783 | 1.992 |
| 2015 | 23.748 | 5.859 | 2.549 | 2.607 | 1.687 |
| 2016 | 8.955 | 13.055 | 3.050 | 1.250 | 1.882 |
| 2017 | 17.153 | 4.791 | 6.609 | 1.454 | 1.308 |

Table RW15A. Expected numbers-at-age (1,000s of fish) at the beginning of the year (January 1st) for male Scamp in the Gulf of Mexico.

| Year | 0 | 1 | 2 | 3 | 4 | 5 | 6 | 7 | 8 | 9 | 10 | 11 |
|------|---|---|---|---|--------|--------|--------|--------|--------|--------|--------|--------|
| 1986 | 0 | 0 | 0 | 0 | 6.055 | 11.165 | 15.202 | 18.098 | 19.871 | 20.612 | 20.467 | 19.610 |
| 1987 | 0 | 0 | 0 | 0 | 5.993 | 10.975 | 14.897 | 17.711 | 19.429 | 20.136 | 19.978 | 19.127 |
| 1988 | 0 | 0 | 0 | 0 | 5.983 | 10.873 | 14.665 | 17.388 | 19.058 | 19.745 | 19.583 | 18.742 |
| 1989 | 0 | 0 | 0 | 0 | 6.006 | 10.930 | 14.670 | 17.335 | 19.002 | 19.717 | 19.586 | 18.765 |
| 1990 | 0 | 0 | 0 | 0 | 2.034 | 11.086 | 14.894 | 17.483 | 19.056 | 19.734 | 19.601 | 18.785 |
| 1991 | 0 | 0 | 0 | 0 | 3.451 | 3.816 | 15.335 | 17.964 | 19.408 | 19.963 | 19.779 | 18.951 |
| 1992 | 0 | 0 | 0 | 0 | 3.393 | 6.441 | 5.230 | 18.256 | 19.626 | 19.967 | 19.619 | 18.730 |
| 1993 | 0 | 0 | 0 | 0 | 6.628 | 6.296 | 8.755 | 6.167 | 19.766 | 20.032 | 19.493 | 18.477 |
| 1994 | 0 | 0 | 0 | 0 | 7.299 | 12.200 | 8.452 | 10.162 | 6.557 | 19.780 | 19.154 | 17.967 |
| 1995 | 0 | 0 | 0 | 0 | 6.163 | 13.674 | 16.839 | 10.173 | 11.268 | 6.870 | 19.853 | 18.565 |
| 1996 | 0 | 0 | 0 | 0 | 5.713 | 11.612 | 19.015 | 20.431 | 11.366 | 11.885 | 6.935 | 19.341 |
| 1997 | 0 | 0 | 0 | 0 | 7.313 | 10.758 | 16.139 | 23.066 | 22.830 | 11.995 | 12.009 | 6.764 |
| 1998 | 0 | 0 | 0 | 0 | 7.291 | 13.701 | 14.823 | 19.348 | 25.412 | 23.715 | 11.916 | 11.506 |
| 1999 | 0 | 0 | 0 | 0 | 5.594 | 13.744 | 19.094 | 18.058 | 21.739 | 26.988 | 24.126 | 11.705 |
| 2000 | 0 | 0 | 0 | 0 | 8.542 | 10.443 | 18.893 | 22.888 | 19.946 | 22.694 | 26.993 | 23.305 |
| 2001 | 0 | 0 | 0 | 0 | 4.451 | 16.096 | 14.566 | 23.082 | 25.845 | 21.328 | 23.278 | 26.763 |
| 2002 | 0 | 0 | 0 | 0 | 5.748 | 8.358 | 22.317 | 17.637 | 25.762 | 27.256 | 21.541 | 22.698 |
| 2003 | 0 | 0 | 0 | 0 | 13.691 | 10.784 | 11.563 | 26.929 | 19.597 | 27.027 | 27.371 | 20.876 |
| 2004 | 0 | 0 | 0 | 0 | 5.441 | 25.114 | 14.404 | 13.413 | 28.800 | 19.843 | 26.260 | 25.713 |
| 2005 | 0 | 0 | 0 | 0 | 11.406 | 9.935 | 33.315 | 16.576 | 14.229 | 28.928 | 19.128 | 24.477 |
| 2006 | 0 | 0 | 0 | 0 | 9.114 | 21.304 | 13.632 | 39.839 | 18.268 | 14.821 | 28.864 | 18.428 |
| 2007 | 0 | 0 | 0 | 0 | 7.626 | 16.968 | 29.157 | 16.313 | 44.129 | 19.206 | 14.977 | 28.235 |
| 2008 | 0 | 0 | 0 | 0 | 4.416 | 14.119 | 23.012 | 34.484 | 17.831 | 45.731 | 19.116 | 14.423 |
| 2009 | 0 | 0 | 0 | 0 | 5.045 | 8.098 | 18.879 | 26.786 | 37.105 | 18.205 | 44.882 | 18.162 |
| 2010 | 0 | 0 | 0 | 0 | 7.459 | 9.288 | 10.897 | 22.153 | 29.088 | 38.268 | 18.061 | 43.130 |
| 2011 | 0 | 0 | 0 | 0 | 6.576 | 13.791 | 12.596 | 12.932 | 24.402 | 30.500 | 38.662 | 17.695 |
| 2012 | 0 | 0 | 0 | 0 | 3.464 | 12.283 | 18.990 | 15.211 | 14.495 | 26.014 | 31.303 | 38.456 |
| 2013 | 0 | 0 | 0 | 0 | 3.604 | 6.229 | 15.956 | 21.408 | 15.874 | 14.396 | 24.906 | 29.078 |
| 2014 | 0 | 0 | 0 | 0 | 3.352 | 6.594 | 8.298 | 18.492 | 22.938 | 16.147 | 14.084 | 23.599 |
| 2015 | 0 | 0 | 0 | 0 | 3.538 | 5.962 | 8.437 | 9.216 | 19.064 | 22.574 | 15.359 | 13.023 |
| 2016 | 0 | 0 | 0 | 0 | 2.286 | 6.171 | 7.405 | 9.053 | 9.173 | 18.127 | 20.764 | 13.743 |
| 2017 | 0 | 0 | 0 | 0 | 2.763 | 4.056 | 7.826 | 8.078 | 9.080 | 8.710 | 16.529 | 18.317 |

Table RW15A Continued. Expected numbers-at-age (1,000s of fish) at the beginning of the year (January 1st) for male Scamp in the Gulf of Mexico.

| Year | 12 | 13 | 14 | 15 | 16 | 17 | 18 | 19 | 20+ |
|------|--------|--------|--------|--------|--------|--------|--------|-------|--------|
| 1986 | 18.219 | 16.470 | 14.524 | 12.518 | 10.565 | 8.750 | 7.126 | 5.721 | 20.546 |
| 1987 | 17.760 | 16.048 | 14.146 | 12.188 | 10.285 | 8.516 | 6.934 | 5.566 | 19.987 |
| 1988 | 17.395 | 15.712 | 13.846 | 11.928 | 10.063 | 8.331 | 6.783 | 5.444 | 19.545 |
| 1989 | 17.429 | 15.749 | 13.883 | 11.961 | 10.092 | 8.356 | 6.804 | 5.461 | 19.609 |
| 1990 | 17.451 | 15.770 | 13.900 | 11.975 | 10.103 | 8.365 | 6.810 | 5.466 | 19.624 |
| 1991 | 17.610 | 15.918 | 14.032 | 12.088 | 10.199 | 8.443 | 6.874 | 5.517 | 19.806 |
| 1992 | 17.387 | 15.712 | 13.847 | 11.927 | 10.060 | 8.327 | 6.778 | 5.439 | 19.520 |
| 1993 | 17.106 | 15.453 | 13.623 | 11.736 | 9.900 | 8.195 | 6.671 | 5.353 | 19.209 |
| 1994 | 16.506 | 14.865 | 13.096 | 11.283 | 9.518 | 7.878 | 6.412 | 5.145 | 18.458 |
| 1995 | 16.899 | 15.116 | 13.286 | 11.444 | 9.659 | 7.997 | 6.510 | 5.224 | 18.745 |
| 1996 | 17.542 | 15.542 | 13.563 | 11.654 | 9.833 | 8.144 | 6.631 | 5.322 | 19.096 |
| 1997 | 18.299 | 16.156 | 13.966 | 11.916 | 10.028 | 8.303 | 6.764 | 5.430 | 19.486 |
| 1998 | 6.284 | 16.540 | 14.245 | 12.036 | 10.057 | 8.305 | 6.763 | 5.430 | 19.493 |
| 1999 | 10.966 | 5.830 | 14.975 | 12.608 | 10.435 | 8.557 | 6.950 | 5.579 | 20.040 |
| 2000 | 10.972 | 10.009 | 5.193 | 13.043 | 10.758 | 8.738 | 7.048 | 5.644 | 20.278 |
| 2001 | 22.436 | 10.290 | 9.163 | 4.650 | 11.441 | 9.263 | 7.401 | 5.886 | 21.103 |
| 2002 | 25.317 | 20.660 | 9.245 | 8.049 | 4.001 | 9.661 | 7.692 | 6.059 | 21.534 |
| 2003 | 21.335 | 23.160 | 18.439 | 8.066 | 6.878 | 3.354 | 7.967 | 6.253 | 21.861 |
| 2004 | 19.046 | 18.961 | 20.093 | 15.645 | 6.705 | 5.612 | 2.692 | 6.304 | 21.687 |
| 2005 | 23.276 | 16.795 | 16.322 | 16.916 | 12.904 | 5.428 | 4.468 | 2.114 | 21.422 |
| 2006 | 22.878 | 21.177 | 14.910 | 14.165 | 14.379 | 10.764 | 4.453 | 3.614 | 18.508 |
| 2007 | 17.522 | 21.205 | 19.172 | 13.205 | 12.295 | 12.253 | 9.024 | 3.681 | 17.794 |
| 2008 | 26.419 | 15.976 | 18.880 | 16.697 | 11.269 | 10.300 | 10.097 | 7.332 | 16.979 |
| 2009 | 13.319 | 23.781 | 14.046 | 16.238 | 14.072 | 9.324 | 8.384 | 8.105 | 19.038 |
| 2010 | 16.973 | 12.137 | 21.171 | 12.236 | 13.864 | 11.797 | 7.691 | 6.819 | 21.569 |
| 2011 | 41.129 | 15.792 | 11.038 | 18.846 | 10.678 | 11.882 | 9.949 | 6.397 | 23.061 |
| 2012 | 17.124 | 38.821 | 14.566 | 9.963 | 16.676 | 9.278 | 10.158 | 8.389 | 24.240 |
| 2013 | 34.783 | 15.115 | 33.499 | 12.304 | 8.252 | 13.563 | 7.426 | 8.019 | 25.148 |
| 2014 | 26.791 | 31.246 | 13.265 | 28.763 | 10.354 | 6.818 | 11.025 | 5.953 | 25.947 |
| 2015 | 21.277 | 23.598 | 26.924 | 11.195 | 23.810 | 8.420 | 5.457 | 8.705 | 24.572 |
| 2016 | 11.368 | 18.150 | 19.696 | 22.013 | 8.978 | 18.759 | 6.530 | 4.175 | 24.859 |
| 2017 | 11.779 | 9.493 | 14.798 | 15.706 | 17.198 | 6.885 | 14.150 | 4.856 | 21.025 |

Table RW15B. Expected biomass-at-age (metric tons) at the beginning of the year (January 1st) for male Scamp in the Gulf of Mexico.

| Year | 0 | 1 | 2 | 3 | 4 | 5 | 6 | 7 | 8 | 9 | 10 | 11 |
|------|---|---|---|---|-------|--------|--------|--------|--------|--------|---------|---------|
| 1986 | 0 | 0 | 0 | 0 | 3.259 | 8.898 | 16.454 | 25.016 | 33.509 | 40.947 | 46.601 | 50.064 |
| 1987 | 0 | 0 | 0 | 0 | 3.226 | 8.747 | 16.123 | 24.481 | 32.764 | 40.001 | 45.487 | 48.832 |
| 1988 | 0 | 0 | 0 | 0 | 3.221 | 8.666 | 15.872 | 24.034 | 32.138 | 39.224 | 44.588 | 47.847 |
| 1989 | 0 | 0 | 0 | 0 | 3.233 | 8.711 | 15.878 | 23.961 | 32.043 | 39.169 | 44.594 | 47.907 |
| 1990 | 0 | 0 | 0 | 0 | 1.095 | 8.835 | 16.120 | 24.165 | 32.135 | 39.203 | 44.629 | 47.959 |
| 1991 | 0 | 0 | 0 | 0 | 1.858 | 3.041 | 16.598 | 24.831 | 32.729 | 39.658 | 45.035 | 48.382 |
| 1992 | 0 | 0 | 0 | 0 | 1.826 | 5.134 | 5.660 | 25.234 | 33.096 | 39.665 | 44.669 | 47.819 |
| 1993 | 0 | 0 | 0 | 0 | 3.568 | 5.018 | 9.476 | 8.525 | 33.332 | 39.795 | 44.382 | 47.172 |
| 1994 | 0 | 0 | 0 | 0 | 3.929 | 9.723 | 9.148 | 14.046 | 11.057 | 39.293 | 43.610 | 45.869 |
| 1995 | 0 | 0 | 0 | 0 | 3.317 | 10.898 | 18.226 | 14.061 | 19.001 | 13.648 | 45.202 | 47.397 |
| 1996 | 0 | 0 | 0 | 0 | 3.075 | 9.255 | 20.581 | 28.240 | 19.166 | 23.610 | 15.791 | 49.378 |
| 1997 | 0 | 0 | 0 | 0 | 3.937 | 8.574 | 17.468 | 31.882 | 38.498 | 23.828 | 27.342 | 17.269 |
| 1998 | 0 | 0 | 0 | 0 | 3.925 | 10.919 | 16.044 | 26.742 | 42.852 | 47.111 | 27.131 | 29.375 |
| 1999 | 0 | 0 | 0 | 0 | 3.011 | 10.953 | 20.666 | 24.961 | 36.659 | 53.613 | 54.932 | 29.882 |
| 2000 | 0 | 0 | 0 | 0 | 4.598 | 8.323 | 20.448 | 31.636 | 33.636 | 45.082 | 61.459 | 59.498 |
| 2001 | 0 | 0 | 0 | 0 | 2.396 | 12.828 | 15.766 | 31.904 | 43.583 | 42.370 | 53.001 | 68.326 |
| 2002 | 0 | 0 | 0 | 0 | 3.094 | 6.662 | 24.155 | 24.378 | 43.442 | 54.145 | 49.047 | 57.948 |
| 2003 | 0 | 0 | 0 | 0 | 7.370 | 8.594 | 12.515 | 37.222 | 33.047 | 53.691 | 62.320 | 53.297 |
| 2004 | 0 | 0 | 0 | 0 | 2.929 | 20.016 | 15.590 | 18.540 | 48.565 | 39.419 | 59.791 | 65.646 |
| 2005 | 0 | 0 | 0 | 0 | 6.139 | 7.918 | 36.059 | 22.912 | 23.995 | 57.466 | 43.552 | 62.489 |
| 2006 | 0 | 0 | 0 | 0 | 4.906 | 16.978 | 14.755 | 55.067 | 30.806 | 29.442 | 65.718 | 47.046 |
| 2007 | 0 | 0 | 0 | 0 | 4.105 | 13.523 | 31.558 | 22.548 | 74.415 | 38.153 | 34.101 | 72.084 |
| 2008 | 0 | 0 | 0 | 0 | 2.377 | 11.253 | 24.907 | 47.665 | 30.068 | 90.848 | 43.526 | 36.822 |
| 2009 | 0 | 0 | 0 | 0 | 2.715 | 6.454 | 20.434 | 37.025 | 62.571 | 36.166 | 102.191 | 46.368 |
| 2010 | 0 | 0 | 0 | 0 | 4.015 | 7.402 | 11.794 | 30.620 | 49.052 | 76.021 | 41.122 | 110.110 |
| 2011 | 0 | 0 | 0 | 0 | 3.540 | 10.991 | 13.633 | 17.875 | 41.150 | 60.589 | 88.027 | 45.176 |
| 2012 | 0 | 0 | 0 | 0 | 1.864 | 9.789 | 20.554 | 21.025 | 24.442 | 51.679 | 71.273 | 98.179 |
| 2013 | 0 | 0 | 0 | 0 | 1.940 | 4.965 | 17.270 | 29.590 | 26.768 | 28.598 | 56.707 | 74.237 |
| 2014 | 0 | 0 | 0 | 0 | 1.804 | 5.255 | 8.982 | 25.560 | 38.680 | 32.077 | 32.066 | 60.247 |
| 2015 | 0 | 0 | 0 | 0 | 1.905 | 4.752 | 9.132 | 12.738 | 32.148 | 44.845 | 34.970 | 33.248 |
| 2016 | 0 | 0 | 0 | 0 | 1.231 | 4.918 | 8.015 | 12.513 | 15.468 | 36.010 | 47.277 | 35.087 |
| 2017 | 0 | 0 | 0 | 0 | 1.487 | 3.233 | 8.471 | 11.165 | 15.311 | 17.304 | 37.634 | 46.763 |

Table RW15B Continued. Expected biomass-at-age (metric tons) at the beginning of the year (January 1st) for male Scamp in the Gulf of Mexico.

| Year | 12 | 13 | 14 | 15 | 16 | 17 | 18 | 19 | 20+ |
|------|---------|---------|---------|---------|--------|--------|--------|--------|---------|
| 1986 | 51.234 | 50.281 | 47.555 | 43.519 | 38.672 | 33.478 | 28.327 | 23.505 | 92.283 |
| 1987 | 49.944 | 48.992 | 46.318 | 42.375 | 37.646 | 32.584 | 27.567 | 22.872 | 89.772 |
| 1988 | 48.918 | 47.968 | 45.338 | 41.468 | 36.834 | 31.876 | 26.965 | 22.370 | 87.785 |
| 1989 | 49.012 | 48.081 | 45.457 | 41.584 | 36.941 | 31.972 | 27.048 | 22.440 | 88.072 |
| 1990 | 49.075 | 48.144 | 45.514 | 41.633 | 36.981 | 32.004 | 27.073 | 22.460 | 88.141 |
| 1991 | 49.523 | 48.595 | 45.944 | 42.027 | 37.330 | 32.305 | 27.327 | 22.670 | 88.958 |
| 1992 | 48.895 | 47.965 | 45.340 | 41.465 | 36.823 | 31.859 | 26.945 | 22.349 | 87.673 |
| 1993 | 48.106 | 47.175 | 44.606 | 40.803 | 36.239 | 31.355 | 26.517 | 21.995 | 86.277 |
| 1994 | 46.417 | 45.380 | 42.881 | 39.227 | 34.840 | 30.143 | 25.491 | 21.141 | 82.904 |
| 1995 | 47.523 | 46.146 | 43.501 | 39.789 | 35.354 | 30.599 | 25.881 | 21.466 | 84.190 |
| 1996 | 49.332 | 47.446 | 44.411 | 40.516 | 35.990 | 31.159 | 26.362 | 21.868 | 85.767 |
| 1997 | 51.461 | 49.321 | 45.729 | 41.426 | 36.706 | 31.770 | 26.888 | 22.311 | 87.520 |
| 1998 | 17.671 | 50.495 | 46.641 | 41.844 | 36.810 | 31.776 | 26.884 | 22.313 | 87.552 |
| 1999 | 30.838 | 17.798 | 49.032 | 43.834 | 38.195 | 32.740 | 27.628 | 22.925 | 90.011 |
| 2000 | 30.856 | 30.557 | 17.005 | 45.346 | 39.377 | 33.435 | 28.018 | 23.190 | 91.082 |
| 2001 | 63.095 | 31.412 | 30.003 | 16.165 | 41.879 | 35.441 | 29.422 | 24.184 | 94.787 |
| 2002 | 71.195 | 63.072 | 30.272 | 27.984 | 14.643 | 36.963 | 30.579 | 24.897 | 96.720 |
| 2003 | 59.997 | 70.703 | 60.376 | 28.042 | 25.175 | 12.835 | 31.670 | 25.695 | 98.176 |
| 2004 | 53.562 | 57.884 | 65.792 | 54.393 | 24.542 | 21.471 | 10.702 | 25.901 | 97.364 |
| 2005 | 65.457 | 51.273 | 53.445 | 58.810 | 47.232 | 20.768 | 17.763 | 8.684 | 96.138 |
| 2006 | 64.336 | 64.651 | 48.819 | 49.247 | 52.630 | 41.183 | 17.701 | 14.848 | 83.884 |
| 2007 | 49.276 | 64.734 | 62.775 | 45.911 | 45.004 | 46.882 | 35.873 | 15.126 | 80.792 |
| 2008 | 74.294 | 48.773 | 61.818 | 58.048 | 41.248 | 39.409 | 40.140 | 30.128 | 77.138 |
| 2009 | 37.457 | 72.600 | 45.991 | 56.453 | 51.510 | 35.676 | 33.329 | 33.301 | 85.570 |
| 2010 | 47.730 | 37.053 | 69.321 | 42.538 | 50.746 | 45.138 | 30.573 | 28.020 | 96.320 |
| 2011 | 115.662 | 48.211 | 36.141 | 65.520 | 39.084 | 45.461 | 39.550 | 26.283 | 103.007 |
| 2012 | 48.155 | 118.515 | 47.693 | 34.639 | 61.039 | 35.499 | 40.383 | 34.468 | 108.469 |
| 2013 | 97.815 | 46.145 | 109.686 | 42.777 | 30.204 | 51.896 | 29.521 | 32.950 | 112.345 |
| 2014 | 75.341 | 95.389 | 43.433 | 100.000 | 37.900 | 26.087 | 43.830 | 24.459 | 115.913 |
| 2015 | 59.834 | 72.041 | 88.158 | 38.921 | 87.152 | 32.217 | 21.693 | 35.769 | 110.209 |
| 2016 | 31.968 | 55.408 | 64.491 | 76.531 | 32.863 | 71.778 | 25.959 | 17.154 | 111.183 |
| 2017 | 33.124 | 28.980 | 48.454 | 54.604 | 62.950 | 26.343 | 56.252 | 19.954 | 94.668 |

Table RW16. Input (with log-scale standard errors, SE) and expected (Exp) landings for the Commercial Vertical Line fleet in biomass (B, million pounds gutted weight) and number (N, 1,000s of fish) for Gulf of Mexico Scamp. The expected mean body weight (gutted pounds per fish) was determined by dividing the expected landings in weights by numbers of fish.

| Year | Input B SE | Input B | Exp B | Exp N | Exp Mean Weight |
|------|------------|---------|-------|--------|-----------------|
| 1986 | 0.05 | 0.184 | 0.184 | 42.822 | 4.3 |
| 1987 | 0.05 | 0.185 | 0.186 | 43.214 | 4.3 |
| 1988 | 0.05 | 0.159 | 0.160 | 36.876 | 4.4 |
| 1989 | 0.05 | 0.164 | 0.165 | 37.267 | 4.4 |
| 1990 | 0.05 | 0.156 | 0.157 | 32.436 | 4.8 |
| 1991 | 0.05 | 0.186 | 0.188 | 37.814 | 5.0 |
| 1992 | 0.05 | 0.226 | 0.228 | 45.737 | 5.0 |
| 1993 | 0.05 | 0.218 | 0.221 | 45.218 | 4.9 |
| 1994 | 0.05 | 0.158 | 0.159 | 33.960 | 4.7 |
| 1995 | 0.05 | 0.175 | 0.176 | 38.572 | 4.6 |
| 1996 | 0.05 | 0.166 | 0.167 | 37.155 | 4.5 |
| 1997 | 0.05 | 0.213 | 0.214 | 47.911 | 4.5 |
| 1998 | 0.05 | 0.136 | 0.136 | 30.508 | 4.4 |
| 1999 | 0.05 | 0.175 | 0.175 | 40.486 | 4.3 |
| 2000 | 0.05 | 0.126 | 0.127 | 29.046 | 4.4 |
| 2001 | 0.05 | 0.156 | 0.156 | 35.143 | 4.4 |
| 2002 | 0.05 | 0.187 | 0.186 | 42.079 | 4.4 |
| 2003 | 0.05 | 0.176 | 0.175 | 38.772 | 4.5 |
| 2004 | 0.05 | 0.167 | 0.166 | 37.373 | 4.5 |
| 2005 | 0.05 | 0.167 | 0.166 | 37.712 | 4.4 |
| 2006 | 0.05 | 0.132 | 0.132 | 30.058 | 4.4 |
| 2007 | 0.05 | 0.155 | 0.154 | 34.634 | 4.5 |
| 2008 | 0.05 | 0.139 | 0.139 | 30.233 | 4.6 |
| 2009 | 0.05 | 0.161 | 0.161 | 33.855 | 4.8 |
| 2010 | 0.01 | 0.091 | 0.091 | 18.336 | 5.0 |
| 2011 | 0.01 | 0.085 | 0.085 | 17.002 | 5.0 |
| 2012 | 0.01 | 0.157 | 0.157 | 30.697 | 5.1 |
| 2013 | 0.01 | 0.142 | 0.142 | 27.012 | 5.2 |
| 2014 | 0.01 | 0.106 | 0.106 | 19.819 | 5.4 |
| 2015 | 0.01 | 0.098 | 0.098 | 17.862 | 5.5 |
| 2016 | 0.01 | 0.143 | 0.143 | 25.800 | 5.5 |
| 2017 | 0.01 | 0.086 | 0.086 | 15.563 | 5.5 |

Table RW17. Input (with log-scale standard errors, SE) and expected (Exp) landings for the Commercial Longline fleet in biomass (B, million pounds gutted weight) and number (N, 1,000s of fish) for Gulf of Mexico Scamp. The expected mean body weight (gutted pounds per fish) was determined by dividing the expected landings in weights by numbers of fish.

| Year | Input B SE | Input B | Exp B | Exp N | Exp Mean Weight |
|------|------------|---------|-------|--------|-----------------|
| 1986 | 0.05 | 0.174 | 0.175 | 31.037 | 5.6 |
| 1987 | 0.05 | 0.154 | 0.155 | 27.473 | 5.6 |
| 1988 | 0.05 | 0.110 | 0.111 | 19.657 | 5.6 |
| 1989 | 0.05 | 0.127 | 0.128 | 22.516 | 5.7 |
| 1990 | 0.05 | 0.109 | 0.110 | 18.792 | 5.8 |
| 1991 | 0.05 | 0.129 | 0.131 | 21.997 | 5.9 |
| 1992 | 0.05 | 0.076 | 0.077 | 12.723 | 6.0 |
| 1993 | 0.05 | 0.102 | 0.103 | 17.034 | 6.0 |
| 1994 | 0.05 | 0.057 | 0.058 | 9.713 | 5.9 |
| 1995 | 0.05 | 0.061 | 0.061 | 10.523 | 5.8 |
| 1996 | 0.05 | 0.067 | 0.067 | 11.783 | 5.7 |
| 1997 | 0.05 | 0.080 | 0.080 | 14.229 | 5.6 |
| 1998 | 0.05 | 0.085 | 0.085 | 15.358 | 5.6 |
| 1999 | 0.05 | 0.085 | 0.085 | 15.501 | 5.5 |
| 2000 | 0.05 | 0.074 | 0.074 | 13.358 | 5.5 |
| 2001 | 0.05 | 0.112 | 0.112 | 20.096 | 5.6 |
| 2002 | 0.05 | 0.118 | 0.118 | 20.952 | 5.6 |
| 2003 | 0.05 | 0.137 | 0.136 | 24.050 | 5.7 |
| 2004 | 0.05 | 0.152 | 0.151 | 26.887 | 5.6 |
| 2005 | 0.05 | 0.142 | 0.141 | 25.471 | 5.5 |
| 2006 | 0.05 | 0.086 | 0.086 | 15.654 | 5.5 |
| 2007 | 0.05 | 0.120 | 0.120 | 21.709 | 5.5 |
| 2008 | 0.05 | 0.139 | 0.139 | 24.715 | 5.6 |
| 2009 | 0.05 | 0.090 | 0.090 | 15.620 | 5.7 |
| 2010 | 0.01 | 0.065 | 0.065 | 10.990 | 5.9 |
| 2011 | 0.01 | 0.060 | 0.060 | 10.073 | 6.0 |
| 2012 | 0.01 | 0.093 | 0.093 | 15.326 | 6.1 |
| 2013 | 0.01 | 0.104 | 0.104 | 16.761 | 6.2 |
| 2014 | 0.01 | 0.062 | 0.062 | 9.867 | 6.3 |
| 2015 | 0.01 | 0.081 | 0.081 | 12.607 | 6.4 |
| 2016 | 0.01 | 0.143 | 0.143 | 22.053 | 6.5 |
| 2017 | 0.01 | 0.077 | 0.077 | 11.803 | 6.5 |

Table RW18. Input (with log-scale standard errors, SE) and expected (Exp) landings for the Recreational Charter Private fleet in number (1,000s of fish) and biomass (B, million pounds gutted weight) for Gulf of Mexico Scamp. The expected mean body weight (gutted pounds per fish) was determined by dividing the expected landings in weights by numbers of fish.

| Year | Input N SE | Input N | Exp N | Exp B | Exp Mean Weight |
|------|------------|---------|--------|-------|-----------------|
| 1986 | 0.05 | 47.775 | 48.616 | 0.124 | 2.6 |
| 1987 | 0.30 | 68.516 | 48.751 | 0.124 | 2.6 |
| 1988 | 0.30 | 39.527 | 43.220 | 0.111 | 2.6 |
| 1989 | 0.30 | 18.611 | 18.871 | 0.052 | 2.7 |
| 1990 | 0.30 | 6.524 | 9.873 | 0.040 | 4.1 |
| 1991 | 0.30 | 14.873 | 12.296 | 0.052 | 4.2 |
| 1992 | 0.30 | 13.651 | 15.427 | 0.065 | 4.2 |
| 1993 | 0.30 | 23.433 | 23.166 | 0.095 | 4.1 |
| 1994 | 0.30 | 12.868 | 11.271 | 0.044 | 3.9 |
| 1995 | 0.30 | 4.330 | 3.765 | 0.014 | 3.8 |
| 1996 | 0.30 | 12.313 | 7.081 | 0.027 | 3.8 |
| 1997 | 0.30 | 14.720 | 10.316 | 0.039 | 3.7 |
| 1998 | 0.30 | 20.733 | 9.738 | 0.036 | 3.7 |
| 1999 | 0.30 | 39.730 | 20.584 | 0.079 | 3.8 |
| 2000 | 0.30 | 10.563 | 12.553 | 0.048 | 3.9 |
| 2001 | 0.30 | 13.574 | 15.246 | 0.060 | 3.9 |
| 2002 | 0.30 | 24.463 | 14.589 | 0.057 | 3.9 |
| 2003 | 0.30 | 45.392 | 58.639 | 0.209 | 3.6 |
| 2004 | 0.30 | 52.108 | 69.566 | 0.244 | 3.5 |
| 2005 | 0.30 | 61.283 | 30.210 | 0.105 | 3.5 |
| 2006 | 0.30 | 105.390 | 45.538 | 0.158 | 3.5 |
| 2007 | 0.30 | 40.461 | 54.545 | 0.193 | 3.5 |
| 2008 | 0.30 | 59.849 | 70.074 | 0.257 | 3.7 |
| 2009 | 0.30 | 49.247 | 55.565 | 0.212 | 3.8 |
| 2010 | 0.30 | 27.407 | 52.781 | 0.203 | 3.9 |
| 2011 | 0.30 | 43.949 | 36.118 | 0.139 | 3.9 |
| 2012 | 0.30 | 76.192 | 86.184 | 0.340 | 3.9 |
| 2013 | 0.30 | 77.150 | 51.637 | 0.210 | 4.1 |
| 2014 | 0.30 | 76.336 | 80.464 | 0.336 | 4.2 |
| 2015 | 0.30 | 105.994 | 88.277 | 0.374 | 4.2 |
| 2016 | 0.30 | 68.552 | 55.750 | 0.238 | 4.3 |
| 2017 | 0.30 | 46.444 | 46.663 | 0.197 | 4.2 |

Table RW19. Input (with log-scale standard errors, SE) and expected (Exp) landings for the Recreational Headboat fleet in number (1,000s of fish) and biomass (B, million pounds gutted weight) for Gulf of Mexico Scamp. The expected mean body weight (gutted pounds per fish) was determined by dividing the expected landings in weights by numbers of fish.

| Year | Input N SE | Input N | Exp N | Exp B | Exp Mean Weight |
|------|------------|---------|-------|-------|-----------------|
| 1986 | 0.05 | 7.263 | 7.266 | 0.018 | 2.5 |
| 1987 | 0.30 | 4.577 | 4.646 | 0.011 | 2.5 |
| 1988 | 0.30 | 3.399 | 3.446 | 0.009 | 2.5 |
| 1989 | 0.30 | 9.310 | 9.686 | 0.026 | 2.7 |
| 1990 | 0.30 | 2.388 | 2.415 | 0.008 | 3.1 |
| 1991 | 0.30 | 2.056 | 2.073 | 0.007 | 3.2 |
| 1992 | 0.30 | 1.611 | 1.618 | 0.005 | 3.1 |
| 1993 | 0.30 | 1.685 | 1.691 | 0.005 | 2.8 |
| 1994 | 0.30 | 1.137 | 1.139 | 0.003 | 2.7 |
| 1995 | 0.30 | 1.370 | 1.371 | 0.004 | 2.7 |
| 1996 | 0.30 | 0.813 | 0.813 | 0.002 | 2.7 |
| 1997 | 0.30 | 1.165 | 1.164 | 0.003 | 2.7 |
| 1998 | 0.30 | 1.241 | 1.239 | 0.003 | 2.7 |
| 1999 | 0.30 | 1.064 | 1.062 | 0.003 | 3.1 |
| 2000 | 0.30 | 1.028 | 1.137 | 0.004 | 3.2 |
| 2001 | 0.30 | 0.616 | 0.569 | 0.002 | 3.3 |
| 2002 | 0.30 | 0.705 | 0.624 | 0.002 | 3.2 |
| 2003 | 0.30 | 0.675 | 0.747 | 0.003 | 3.5 |
| 2004 | 0.30 | 1.315 | 1.351 | 0.005 | 3.4 |
| 2005 | 0.30 | 1.075 | 0.900 | 0.003 | 3.4 |
| 2006 | 0.30 | 0.589 | 0.561 | 0.002 | 3.4 |
| 2007 | 0.30 | 0.668 | 0.732 | 0.003 | 3.5 |
| 2008 | 0.30 | 0.608 | 1.085 | 0.004 | 3.6 |
| 2009 | 0.30 | 0.598 | 1.014 | 0.004 | 3.8 |
| 2010 | 0.30 | 0.992 | 1.250 | 0.005 | 3.8 |
| 2011 | 0.30 | 0.815 | 1.185 | 0.005 | 3.8 |
| 2012 | 0.30 | 1.096 | 1.507 | 0.006 | 3.9 |
| 2013 | 0.30 | 1.388 | 1.761 | 0.007 | 4.0 |
| 2014 | 0.30 | 2.100 | 2.642 | 0.011 | 4.2 |
| 2015 | 0.30 | 2.613 | 3.221 | 0.014 | 4.2 |
| 2016 | 0.30 | 1.730 | 1.917 | 0.008 | 4.3 |
| 2017 | 0.30 | 1.537 | 1.546 | 0.006 | 4.2 |

Table RW20. Input (with log-scale standard errors, SE) and expected (Exp) discards for the Commercial Vertical Line fleet in number (N, 1,000s of fish) and biomass (B, thousand pounds gutted weight) for Gulf of Mexico Scamp. Dead discards in numbers (discard mortality rate = 0.47), biomass, and mean weight (MW, gutted pounds per fish) are included.

| Year | Input N SE | Input N | Exp N | Exp Dead N | Exp B | Exp Dead B | Exp MW |
|------|------------|---------|-------|------------|--------|------------|--------|
| 1986 | | | 0.002 | 0.001 | 0.008 | 0.004 | 4.4 |
| 1987 | | | 0.002 | 0.001 | 0.009 | 0.004 | 4.3 |
| 1988 | | | 0.002 | 0.001 | 0.007 | 0.003 | 4.3 |
| 1989 | | | 0.002 | 0.001 | 0.007 | 0.004 | 4.4 |
| 1990 | | | 3.355 | 1.577 | 5.629 | 2.646 | 1.7 |
| 1991 | | | 4.282 | 2.012 | 6.536 | 3.072 | 1.5 |
| 1992 | | | 6.203 | 2.915 | 8.814 | 4.142 | 1.4 |
| 1993 | | | 7.045 | 3.311 | 10.022 | 4.711 | 1.4 |
| 1994 | | | 5.523 | 2.596 | 8.070 | 3.793 | 1.5 |
| 1995 | | | 6.202 | 2.915 | 9.195 | 4.322 | 1.5 |
| 1996 | | | 5.853 | 2.751 | 8.793 | 4.133 | 1.5 |
| 1997 | | | 7.417 | 3.486 | 11.231 | 5.278 | 1.5 |
| 1998 | | | 4.538 | 2.133 | 6.992 | 3.286 | 1.5 |
| 1999 | | | 2.812 | 1.322 | 2.923 | 1.374 | 1.0 |
| 2000 | 0.390 | 2.946 | 2.028 | 0.953 | 1.951 | 0.917 | 1.0 |
| 2001 | 0.390 | 3.470 | 2.756 | 1.295 | 2.555 | 1.201 | 0.9 |
| 2002 | 0.390 | 3.842 | 3.596 | 1.690 | 3.448 | 1.621 | 1.0 |
| 2003 | 0.390 | 4.236 | 5.189 | 2.439 | 5.283 | 2.483 | 1.0 |
| 2004 | 0.390 | 4.083 | 5.055 | 2.376 | 5.200 | 2.444 | 1.0 |
| 2005 | 0.390 | 3.611 | 4.708 | 2.213 | 5.061 | 2.379 | 1.1 |
| 2006 | 0.390 | 3.231 | 3.081 | 1.448 | 3.427 | 1.610 | 1.1 |
| 2007 | 0.390 | 3.080 | 2.907 | 1.366 | 3.161 | 1.485 | 1.1 |
| 2008 | 0.405 | 2.748 | 2.470 | 1.161 | 2.537 | 1.192 | 1.0 |
| 2009 | 0.412 | 3.356 | 3.002 | 1.411 | 3.127 | 1.470 | 1.0 |
| 2010 | 0.421 | 2.421 | 2.731 | 1.283 | 4.544 | 2.136 | 1.7 |
| 2011 | 0.421 | 2.736 | 2.261 | 1.063 | 3.959 | 1.861 | 1.8 |
| 2012 | 0.421 | 3.423 | 3.639 | 1.710 | 6.556 | 3.081 | 1.8 |
| 2013 | 0.421 | 2.822 | 3.084 | 1.450 | 5.599 | 2.631 | 1.8 |
| 2014 | 0.421 | 2.657 | 2.271 | 1.067 | 4.142 | 1.947 | 1.8 |
| 2015 | 0.421 | 2.302 | 2.121 | 0.997 | 3.779 | 1.776 | 1.8 |
| 2016 | 0.421 | 2.790 | 3.588 | 1.686 | 5.848 | 2.749 | 1.6 |
| 2017 | 0.421 | 2.112 | 2.846 | 1.338 | 4.241 | 1.993 | 1.5 |

Table RW21. Input (with log-scale standard errors, SE) and expected (Exp) discards for the Commercial Longline fleet in number (N, 1,000s of fish) and biomass (B, thousand pounds gutted weight) for Gulf of Mexico Scamp. Dead discards in numbers (discard mortality rate = 0.68), biomass, and mean weight (MW, gutted pounds per fish) are included.

| Year | Input N SE | Input N | Exp N | Exp Dead N | Exp B | Exp Dead B | Exp MW |
|------|------------|---------|-------|------------|-------|------------|--------|
| 1986 | | | 0.001 | 0.001 | 0.008 | 0.006 | 5.7 |
| 1987 | | | 0.001 | 0.001 | 0.007 | 0.005 | 5.4 |
| 1988 | | | 0.001 | 0.001 | 0.005 | 0.003 | 5.6 |
| 1989 | | | 0.001 | 0.001 | 0.006 | 0.004 | 5.2 |
| 1990 | | | 0.552 | 0.375 | 1.155 | 0.785 | 2.1 |
| 1991 | | | 0.652 | 0.443 | 1.287 | 0.875 | 2.0 |
| 1992 | | | 0.431 | 0.293 | 0.785 | 0.534 | 1.8 |
| 1993 | | | 0.683 | 0.464 | 1.203 | 0.818 | 1.8 |
| 1994 | | | 0.431 | 0.293 | 0.769 | 0.523 | 1.8 |
| 1995 | | | 0.479 | 0.326 | 0.870 | 0.592 | 1.8 |
| 1996 | | | 0.533 | 0.363 | 0.981 | 0.667 | 1.8 |
| 1997 | | | 0.636 | 0.433 | 1.182 | 0.804 | 1.9 |
| 1998 | | | 0.665 | 0.452 | 1.253 | 0.852 | 1.9 |
| 1999 | | | 0.366 | 0.249 | 0.416 | 0.283 | 1.1 |
| 2000 | 0.497 | 0.462 | 0.291 | 0.198 | 0.320 | 0.218 | 1.1 |
| 2001 | 0.497 | 0.564 | 0.462 | 0.314 | 0.484 | 0.329 | 1.0 |
| 2002 | 0.497 | 0.533 | 0.573 | 0.390 | 0.619 | 0.421 | 1.1 |
| 2003 | 0.497 | 0.643 | 0.931 | 0.633 | 1.220 | 0.830 | 1.3 |
| 2004 | 0.497 | 0.688 | 1.067 | 0.725 | 1.403 | 0.954 | 1.3 |
| 2005 | 0.497 | 0.692 | 0.985 | 0.670 | 1.337 | 0.909 | 1.4 |
| 2006 | 0.497 | 0.510 | 0.526 | 0.357 | 0.743 | 0.505 | 1.4 |
| 2007 | 0.497 | 0.537 | 0.595 | 0.404 | 0.852 | 0.579 | 1.4 |
| 2008 | 0.497 | 0.667 | 0.599 | 0.407 | 0.828 | 0.563 | 1.4 |
| 2009 | 0.497 | 0.430 | 0.384 | 0.261 | 0.520 | 0.353 | 1.4 |
| 2010 | 0.333 | 0.251 | 0.449 | 0.306 | 0.880 | 0.598 | 2.0 |
| 2011 | 0.333 | 0.403 | 0.384 | 0.261 | 0.782 | 0.532 | 2.0 |
| 2012 | 0.333 | 0.379 | 0.521 | 0.354 | 1.097 | 0.746 | 2.1 |
| 2013 | 0.333 | 0.458 | 0.530 | 0.360 | 1.128 | 0.767 | 2.1 |
| 2014 | 0.333 | 0.524 | 0.303 | 0.206 | 0.647 | 0.440 | 2.1 |
| 2015 | 0.333 | 0.618 | 0.389 | 0.265 | 0.822 | 0.559 | 2.1 |
| 2016 | 0.333 | 0.664 | 0.747 | 0.508 | 1.491 | 1.013 | 2.0 |
| 2017 | 0.333 | 0.644 | 0.501 | 0.341 | 0.916 | 0.623 | 1.8 |

Table RW22. Input (with log-scale standard errors, SE) and expected (Exp) discards for the Recreational Charter Private fleet in number (N, 1,000s of fish) and biomass (B, thousand pounds gutted weight) for Gulf of Mexico Scamp. Dead discards in numbers (discard mortality rate = 0.26), biomass, and mean weight (MW, gutted pounds per fish) are included.

| Year | Input N SE | Input N | Exp N | Exp Dead N | Exp B | Exp Dead B | Exp MW |
|------|------------|---------|---------|------------|---------|------------|--------|
| 1986 | 0.609 | 54.118 | 9.316 | 2.422 | 6.809 | 1.770 | 0.7 |
| 1987 | 0.646 | 1.428 | 9.385 | 2.440 | 6.874 | 1.787 | 0.7 |
| 1988 | 0.783 | 3.701 | 6.164 | 1.603 | 4.616 | 1.200 | 0.7 |
| 1989 | 0.617 | 1.858 | 2.337 | 0.608 | 1.676 | 0.436 | 0.7 |
| 1990 | 0.601 | 40.696 | 11.810 | 3.071 | 16.232 | 4.220 | 1.4 |
| 1991 | 0.833 | 3.128 | 16.995 | 4.419 | 21.580 | 5.611 | 1.3 |
| 1992 | 0.506 | 31.849 | 28.839 | 7.498 | 34.557 | 8.985 | 1.2 |
| 1993 | 0.489 | 40.068 | 51.007 | 13.262 | 62.223 | 16.178 | 1.2 |
| 1994 | 0.639 | 12.792 | 24.024 | 6.246 | 30.498 | 7.930 | 1.3 |
| 1995 | 0.578 | 4.780 | 7.497 | 1.949 | 9.615 | 2.500 | 1.3 |
| 1996 | 0.757 | 0.930 | 14.063 | 3.656 | 17.859 | 4.643 | 1.3 |
| 1997 | 0.578 | 7.025 | 19.765 | 5.139 | 25.563 | 6.646 | 1.3 |
| 1998 | 0.481 | 4.545 | 17.949 | 4.667 | 23.198 | 6.032 | 1.3 |
| 1999 | 0.530 | 9.645 | 39.867 | 10.366 | 53.463 | 13.900 | 1.3 |
| 2000 | 0.751 | 63.768 | 21.806 | 5.669 | 30.155 | 7.840 | 1.4 |
| 2001 | 0.661 | 54.874 | 29.265 | 7.609 | 37.554 | 9.764 | 1.3 |
| 2002 | 0.349 | 19.904 | 32.507 | 8.452 | 41.231 | 10.720 | 1.3 |
| 2003 | 0.403 | 170.019 | 91.972 | 23.913 | 107.821 | 28.034 | 1.2 |
| 2004 | 0.322 | 176.484 | 110.610 | 28.759 | 128.428 | 33.391 | 1.2 |
| 2005 | 0.322 | 26.932 | 45.348 | 11.790 | 53.981 | 14.035 | 1.2 |
| 2006 | 0.455 | 19.127 | 56.611 | 14.719 | 69.915 | 18.178 | 1.2 |
| 2007 | 0.322 | 89.096 | 54.507 | 14.172 | 68.757 | 17.877 | 1.3 |
| 2008 | 0.358 | 114.679 | 69.228 | 17.999 | 84.186 | 21.887 | 1.2 |
| 2009 | 0.472 | 143.342 | 64.419 | 16.749 | 76.411 | 19.867 | 1.2 |
| 2010 | 0.385 | 232.070 | 61.133 | 15.895 | 75.156 | 19.540 | 1.2 |
| 2011 | 0.438 | 31.442 | 34.779 | 9.042 | 44.372 | 11.537 | 1.3 |
| 2012 | 0.617 | 184.383 | 73.696 | 19.161 | 94.091 | 24.462 | 1.3 |
| 2013 | 0.498 | 28.365 | 44.930 | 11.682 | 56.388 | 14.661 | 1.3 |
| 2014 | 0.312 | 125.895 | 72.792 | 18.926 | 91.318 | 23.744 | 1.3 |
| 2015 | 0.498 | 184.662 | 80.447 | 20.916 | 100.568 | 26.147 | 1.3 |
| 2016 | 0.349 | 59.087 | 62.289 | 16.195 | 72.876 | 18.947 | 1.2 |
| 2017 | 0.609 | 77.092 | 73.537 | 19.120 | 82.591 | 21.474 | 1.1 |

Table RW23. Input (with log-scale standard errors, SE) and expected (Exp) discards for the Recreational Headboat fleet in number (N, 1,000s of fish) and biomass (B, thousand pounds gutted weight) for Gulf of Mexico Scamp. Dead discards in numbers (discard mortality rate = 0.26), biomass, and mean weight (MW, gutted pounds per fish) are included.

| Year | Input N SE | Input N | Exp N | Exp Dead N | Exp B | Exp Dead B | Exp MW |
|------|------------|---------|-------|------------|-------|------------|--------|
| 1986 | | | 0.000 | 0.000 | 0.001 | 0.000 | 2.5 |
| 1987 | | | 0.000 | 0.000 | 0.001 | 0.000 | 2.5 |
| 1988 | | | 0.000 | 0.000 | 0.000 | 0.000 | 2.6 |
| 1989 | | | 0.000 | 0.000 | 0.001 | 0.000 | 3.0 |
| 1990 | | | 1.355 | 0.352 | 2.945 | 0.766 | 2.2 |
| 1991 | | | 1.315 | 0.342 | 2.674 | 0.695 | 2.0 |
| 1992 | | | 1.183 | 0.308 | 2.167 | 0.563 | 1.8 |
| 1993 | | | 1.253 | 0.326 | 2.197 | 0.571 | 1.8 |
| 1994 | | | 0.797 | 0.207 | 1.406 | 0.366 | 1.8 |
| 1995 | | | 0.938 | 0.244 | 1.662 | 0.432 | 1.8 |
| 1996 | | | 0.562 | 0.146 | 0.989 | 0.257 | 1.8 |
| 1997 | | | 0.783 | 0.203 | 1.398 | 0.363 | 1.8 |
| 1998 | | | 0.825 | 0.215 | 1.484 | 0.386 | 1.8 |
| 1999 | | | 1.462 | 0.380 | 2.695 | 0.701 | 1.8 |
| 2000 | 0.472 | 1.811 | 1.462 | 0.380 | 2.789 | 0.725 | 1.9 |
| 2001 | 0.472 | 0.676 | 0.791 | 0.206 | 1.448 | 0.376 | 1.8 |
| 2002 | 0.472 | 0.768 | 0.979 | 0.255 | 1.721 | 0.447 | 1.8 |
| 2003 | 0.472 | 1.040 | 0.840 | 0.218 | 1.060 | 0.276 | 1.3 |
| 2004 | 0.472 | 1.610 | 1.511 | 0.393 | 1.892 | 0.492 | 1.3 |
| 2005 | 0.472 | 0.685 | 0.973 | 0.253 | 1.246 | 0.324 | 1.3 |
| 2006 | 0.472 | 0.469 | 0.517 | 0.134 | 0.682 | 0.177 | 1.3 |
| 2007 | 0.472 | 0.671 | 0.553 | 0.144 | 0.741 | 0.193 | 1.3 |
| 2008 | 0.472 | 2.799 | 0.785 | 0.204 | 1.019 | 0.265 | 1.3 |
| 2009 | 0.472 | 2.682 | 0.844 | 0.219 | 1.073 | 0.279 | 1.3 |
| 2010 | 0.472 | 1.760 | 1.068 | 0.278 | 1.401 | 0.364 | 1.3 |
| 2011 | 0.472 | 1.936 | 0.862 | 0.224 | 1.165 | 0.303 | 1.4 |
| 2012 | 0.472 | 1.909 | 0.966 | 0.251 | 1.304 | 0.339 | 1.4 |
| 2013 | 0.472 | 1.895 | 1.132 | 0.294 | 1.508 | 0.392 | 1.3 |
| 2014 | 0.472 | 2.970 | 1.764 | 0.459 | 2.353 | 0.612 | 1.3 |
| 2015 | 0.472 | 3.500 | 2.171 | 0.564 | 2.882 | 0.749 | 1.3 |
| 2016 | 0.472 | 1.880 | 1.507 | 0.392 | 1.891 | 0.492 | 1.3 |
| 2017 | 0.472 | 1.689 | 1.669 | 0.434 | 2.021 | 0.525 | 1.2 |

Table RW24. Input (with log-scale standard errors, SE) versus expected (Exp) standardized fishery-dependent catch-per-unit-effort (CPUE) indices for Gulf of Mexico Scamp. SEs shown below include extra SD estimated and added to the original SEs (see **Table 9** in the SEDAR 68 AP Report).

| Year | ComVL (Input) | ComVL (Exp) | ComVL (SE) | Headboat (Input) | Headboat (Exp) | Headboat (SE) |
|------|---------------|-------------|------------|------------------|----------------|---------------|
| 1986 | | | | 2.015 | 1.676 | 0.228 |
| 1987 | | | | 1.384 | 1.649 | 0.233 |
| 1988 | | | | 1.477 | 1.581 | 0.220 |
| 1989 | | | | 0.817 | 1.424 | 0.225 |
| 1990 | | | | 1.172 | 0.815 | 0.223 |
| 1991 | | | | 0.979 | 0.746 | 0.229 |
| 1992 | | | | 0.708 | 0.756 | 0.223 |
| 1993 | 0.986 | 0.764 | 0.262 | 0.745 | 0.839 | 0.223 |
| 1994 | 0.849 | 0.754 | 0.260 | 0.863 | 0.926 | 0.222 |
| 1995 | 1.254 | 0.780 | 0.260 | 1.208 | 0.981 | 0.226 |
| 1996 | 1.048 | 0.816 | 0.260 | 0.846 | 1.027 | 0.233 |
| 1997 | 1.314 | 0.851 | 0.260 | 0.764 | 1.079 | 0.251 |
| 1998 | 0.991 | 0.890 | 0.260 | 0.967 | 1.109 | 0.242 |
| 1999 | 0.954 | 0.962 | 0.259 | 0.679 | 0.790 | 0.263 |
| 2000 | 0.634 | 1.003 | 0.260 | 0.806 | 0.809 | 0.243 |
| 2001 | 1.005 | 1.040 | 0.259 | 0.667 | 0.796 | 0.254 |
| 2002 | 0.991 | 1.065 | 0.259 | 1.005 | 0.818 | 0.236 |
| 2003 | 0.948 | 1.072 | 0.260 | 0.791 | 1.051 | 0.255 |
| 2004 | 1.081 | 1.079 | 0.260 | 1.329 | 1.095 | 0.232 |
| 2005 | 1.302 | 1.109 | 0.260 | 1.287 | 1.145 | 0.233 |
| 2006 | 0.847 | 1.168 | 0.260 | 0.943 | 1.214 | 0.258 |
| 2007 | 1.001 | 1.213 | 0.260 | 1.546 | 1.214 | 0.258 |
| 2008 | 0.966 | 1.215 | 0.260 | 1.440 | 1.120 | 0.241 |
| 2009 | 0.829 | 1.189 | 0.260 | 0.912 | 1.012 | 0.237 |
| 2010 | | | | 0.708 | 0.977 | 0.273 |
| 2011 | | | | 1.757 | 0.980 | 0.247 |
| 2012 | | | | 1.066 | 0.909 | 0.226 |

Table RW24 Continued. Input (with log-scale standard errors, SE) versus expected (Exp) standardized fishery-dependent catch-per-unit-effort (CPUE) indices for Gulf of Mexico Scamp. SEs shown below include extra SD estimated and added to the original SEs (see **Table 9** in the SEDAR 68 AP Report).

| Year | ComVL (Input) | ComVL (Exp) | ComVL (SE) | Headboat (Input) | Headboat (Exp) | Headboat (SE) |
|------|---------------|-------------|------------|------------------|----------------|---------------|
| 2013 | | | | 0.676 | 0.795 | 0.261 |
| 2014 | | | | 0.733 | 0.696 | 0.238 |
| 2015 | | | | 0.785 | 0.603 | 0.237 |
| 2016 | | | | 0.461 | 0.515 | 0.233 |
| 2017 | | | | 0.460 | 0.460 | 0.256 |

Table RW25. Input (with log-scale standard errors, SE) versus expected (Exp) standardized fishery-independent index or survey for Gulf of Mexico Scamp. SEs shown below include extra SD estimated and added to the original SEs (see **Table 9** in the SEDAR 68 AP Report).

| Year | Combined Video (Input) | Combined Video (Exp) | Combined Video (SE) | RFOP VL (Input) | RFOP VL (Exp) | RFOP VL (SE) |
|------|------------------------|----------------------|---------------------|-----------------|---------------|--------------|
| 1993 | 0.870 | 0.906 | 0.303 | | | |
| 1994 | 0.497 | 0.941 | 0.363 | | | |
| 1995 | 0.565 | 0.991 | 0.383 | | | |
| 1996 | 0.778 | 1.044 | 0.305 | | | |
| 1997 | 0.645 | 1.076 | 0.265 | | | |
| 2002 | 1.758 | 1.297 | 0.273 | | | |
| 2004 | 1.990 | 1.393 | 0.305 | | | |
| 2005 | 1.499 | 1.394 | 0.265 | | | |
| 2006 | 0.941 | 1.340 | 0.299 | | | |
| 2007 | 1.532 | 1.254 | 0.252 | 0.923 | 1.404 | 0.408 |
| 2008 | 1.131 | 1.196 | 0.278 | 0.998 | 1.330 | 0.481 |
| 2009 | 1.228 | 1.161 | 0.259 | 0.979 | 1.260 | 0.490 |
| 2010 | 1.071 | 1.100 | 0.255 | 0.682 | 1.222 | 0.503 |
| 2011 | 1.182 | 1.020 | 0.229 | 0.602 | 1.186 | 0.435 |
| 2012 | 0.673 | 0.920 | 0.251 | 1.206 | 1.096 | 0.364 |
| 2013 | 0.729 | 0.824 | 0.250 | 1.072 | 0.981 | 0.522 |

Table RW25 Continued. Input (with log-scale standard errors, SE) versus expected (Exp) standardized fishery-independent index or survey for Gulf of Mexico Scamp. SEs shown below include extra SD estimated and added to the original SEs (see **Table 9** in the SEDAR 68 AP Report).

| Year | Combined Video (Input) | Combined Video (Exp) | Combined Video (SE) | RFOP VL (Input) | RFOP VL (Exp) | RFOP VL (SE) |
|------|------------------------|----------------------|---------------------|-----------------|---------------|--------------|
| 2014 | 0.876 | 0.734 | 0.249 | 0.864 | 0.875 | 0.399 |
| 2015 | 0.938 | 0.649 | 0.263 | 1.142 | 0.761 | 0.379 |
| 2016 | 0.790 | 0.612 | 0.233 | 1.251 | 0.661 | 0.403 |
| 2017 | 0.751 | 0.630 | 0.247 | 1.066 | 0.613 | 0.430 |

Table RW26. Summary of correlated parameter combinations with correlation coefficients exceeding 0.7 for the Gulf of Mexico Scamp SEDAR 68 RW Base Model.

| Parameter 1 | Parameter 2 | Correlation |
|---|--|-------------|
| Main_RecrDev_1994 | Main_RecrDev_1993 | -0.722 |
| Main_RecrDev_1995 | Main_RecrDev_1994 | -0.749 |
| Main_RecrDev_1996 | Main_RecrDev_1995 | -0.726 |
| Main_RecrDev_2000 | Main_RecrDev_1999 | -0.771 |
| Main_RecrDev_2001 | Main_RecrDev_2000 | -0.817 |
| Main_RecrDev_2002 | Main_RecrDev_2001 | -0.835 |
| Main_RecrDev_2003 | Main_RecrDev_2002 | -0.839 |
| Retain_L_width_Charter_Private(3)_BLK2repl_1999 | Retain_L_infl_Charter_Private(3)_BLK2repl_1999 | 0.717 |
| Retain_L_width_Charter_Private(3)_BLK2repl_2003 | Retain_L_infl_Charter_Private(3)_BLK2repl_2003 | 0.730 |
| Retain_L_width_ComLL(2)_BLK1repl_2010 | Retain_L_infl_ComLL(2)_BLK1repl_2010 | -0.703 |
| Size_95%width_ComLL(2) | Size_inflection_ComLL(2) | 0.722 |
| Size_DblN_ascend_se_Charter_Private(3) | Size_DblN_peak_Charter_Private(3) | 0.939 |
| Size_DblN_ascend_se_Headboat(4) | Size_DblN_peak_Headboat(4) | 0.966 |
| Size_DblN_ascend_se_Headboat(4) | Size_DblN_top_logit_Headboat(4) | -0.966 |
| Size_DblN_descend_se_Charter_Private(3) | Size_DblN_top_logit_Charter_Private(3) | -0.817 |
| Size_DblN_top_logit_Headboat(4) | Size_DblN_peak_Headboat(4) | -1.000 |

Table RW27. Summary of sensitivity runs conducted for the Gulf of Mexico Scamp SEDAR 68 AP Base Model. NLL = negative log-likelihood, CV = coefficient of variation, L_{∞} = von Bertalanffy asymptotic length, K = von Bertalanffy growth rate, and CV_{Amax} = variability in age-at-length of the oldest age group.

| Description | NLL | Gradient | Estimated Parameters (Bounded) | Parameters with CV>1 |
|---|----------|----------|--------------------------------|----------------------|
| SEDAR 68 RW Base | 7,826.97 | 0.026 | 230 (0) | 13 |
| Indices of Abundance | | | | |
| No preIFQ Commercial Vertical Line | 7,840.98 | 0.031 | 230 (0) | 14 |
| No Headboat | 7,853.06 | 0.002 | 230 (0) | 20 |
| No Video | 7,841.78 | 0.006 | 230 (0) | 15 |
| No RFOP | 7,830.55 | 0.000 | 230 (0) | 15 |
| No Fishery-dependent | 7,871.23 | 0.020 | 230 (0) | 21 |
| Growth | | | | |
| Estimate L_{∞} and K with symmetric beta prior | 7,639.37 | 0.005 | 232 (0) | 15 |
| Estimate L_{∞} with symmetric beta prior | 7,733.36 | 0.007 | 231 (0) | 16 |
| Estimate K with symmetric beta prior | 7,680.08 | 0.012 | 231 (0) | 16 |
| Estimate CV_{Amax} parameter | 7,824.30 | 0.004 | 231 (0) | 14 |
| Fix CV_{Amax} parameter at 0.2 | 7,898.84 | 0.025 | 230 (0) | 15 |

Table RW27 Continued. Summary of sensitivity runs conducted for the Gulf of Mexico Scamp SEDAR 68 AP Base Model. σ_R = recruitment variability, R_0 = virgin equilibrium recruitment, L_{Amin} = length of age-1, L_∞ = von Bertalanffy asymptotic length, K = von Bertalanffy growth rate, and CV_{Amax} = variability in age-at-length of the oldest age group.

| Description | Steepness | σ_R | $\ln(R_0)$ | Virgin SSB (metric tons) | Virgin Recruitment (1,000s of fish) |
|---|-----------|------------|------------|-----------------------------|---|
| SEDAR 68 RW Base | 0.694 | 0.445 | 7.417 | 3,817 | 1,664 |
| Indices of Abundance | | | | | |
| No preIFQ Commercial Vertical Line | 0.694 | 0.449 | 7.412 | 3,798 | 1,655 |
| No Headboat | 0.694 | 0.416 | 7.530 | 4,232 | 1,863 |
| No Video | 0.694 | 0.460 | 7.408 | 3,778 | 1,649 |
| No RFOP | 0.694 | 0.453 | 7.413 | 3,798 | 1,657 |
| No Fishery-dependent | 0.694 | 0.430 | 7.504 | 4,126 | 1,815 |
| Growth | | | | | |
| Estimate L_∞ and K with symmetric beta prior | 0.694 | 0.486 | 7.480 | 3,742 | 1,772 |
| Estimate L_∞ with symmetric beta prior | 0.694 | 0.471 | 7.648 | 4,364 | 2,096 |
| Estimate K with symmetric beta prior | 0.694 | 0.484 | 7.618 | 4,152 | 2,034 |
| Estimate CV_{Amax} parameter | 0.694 | 0.444 | 7.430 | 3,861 | 1,686 |
| Fix CV_{Amax} parameter at 0.2 | 0.694 | 0.452 | 7.340 | 3,583 | 1,541 |

| Description | L_{Amin} | L_∞ | K | CV_{Amax} |
|---|------------|------------|-------|-------------|
| SEDAR 68 RW Base | 10.188 | | | |
| Growth | | | | |
| Estimate L_∞ and K with symmetric beta prior | 24.446 | 88.227 | 0.055 | |
| Estimate L_∞ with symmetric beta prior | 18.416 | 66.326 | | |
| Estimate K with symmetric beta prior | 21.946 | | 0.101 | |
| Estimate CV_{Amax} parameter | 15.358 | | | 0.116 |
| Fix CV_{Amax} parameter at 0.2 | 14.703 | | | |

11.2 SEDAR 68 RW Base Model Figures

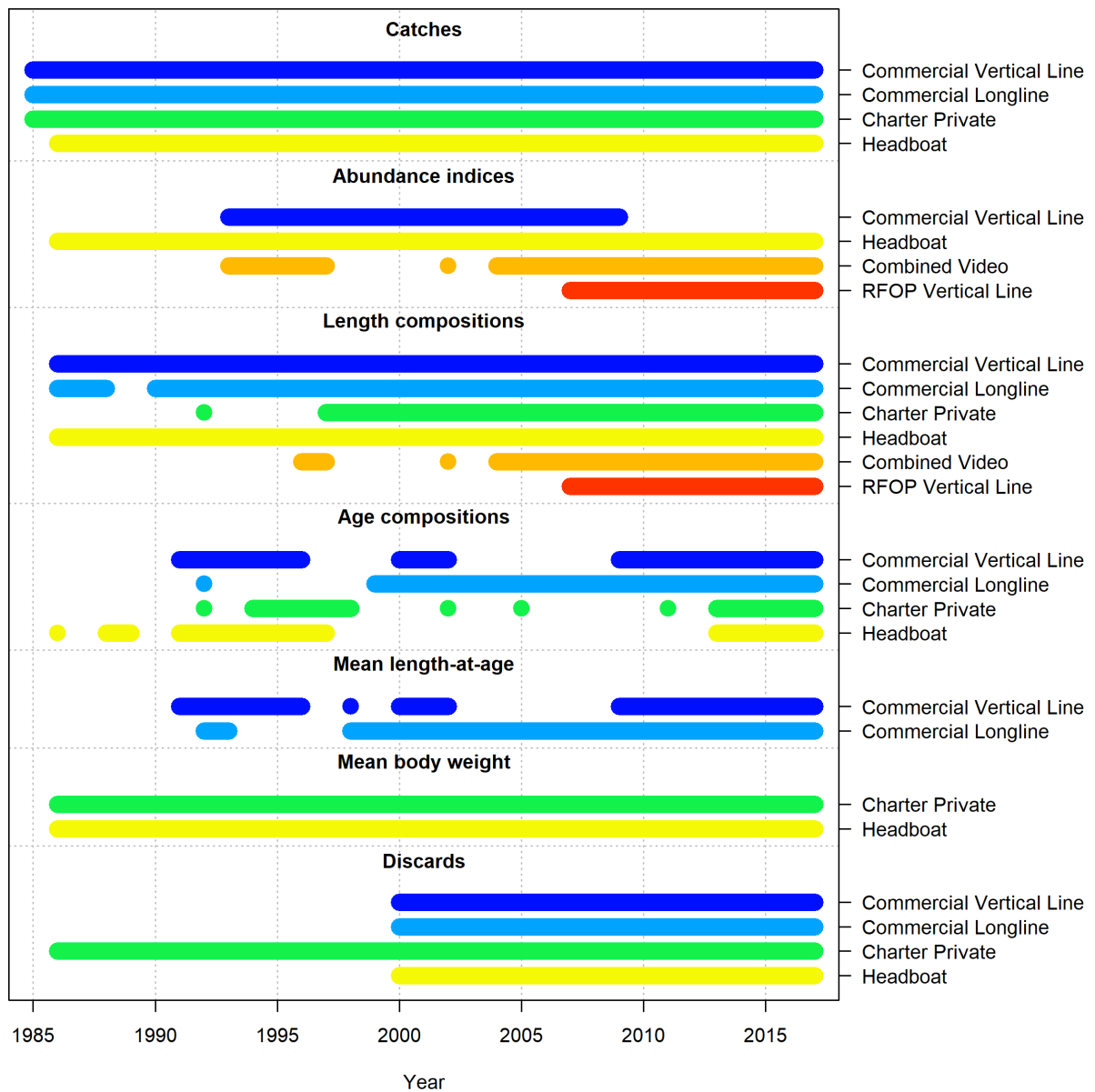

Figure RW1. Data sources used in the SEDAR 68 RW Base Model for Gulf of Mexico Scamp.

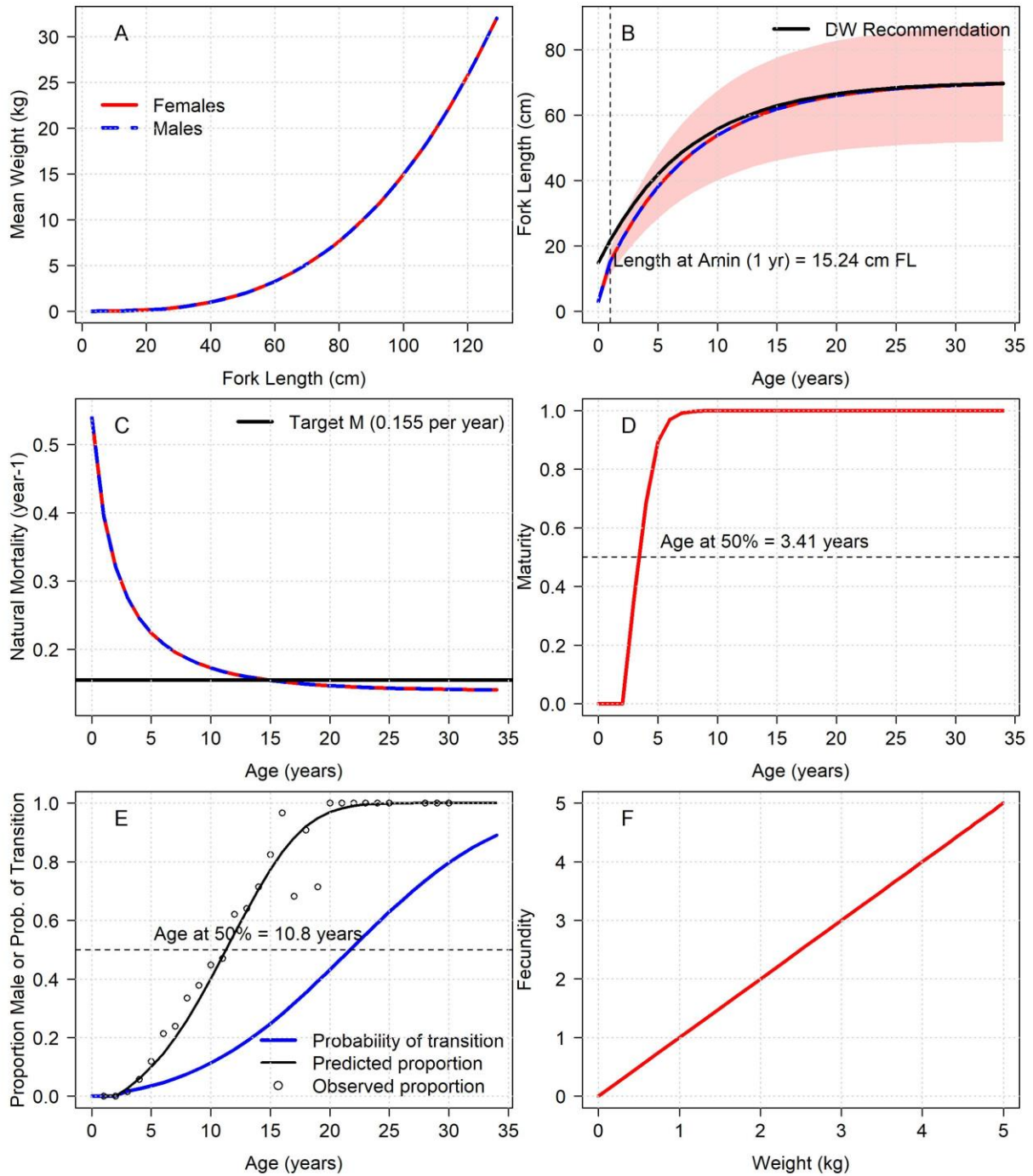

Figure RW2. Life history relationships for Gulf of Mexico Scamp including (A) mean body weight-at-length, (B) recommended and estimated growth curves (shaded area indicates the 95% distribution of length-at-age), (C) natural mortality-at-age, (D) maturity-at-age, (E) the hermaphroditism transition rate (probability of transition and proportion male also shown but not required by SS as an input), and (F) fecundity at weight.

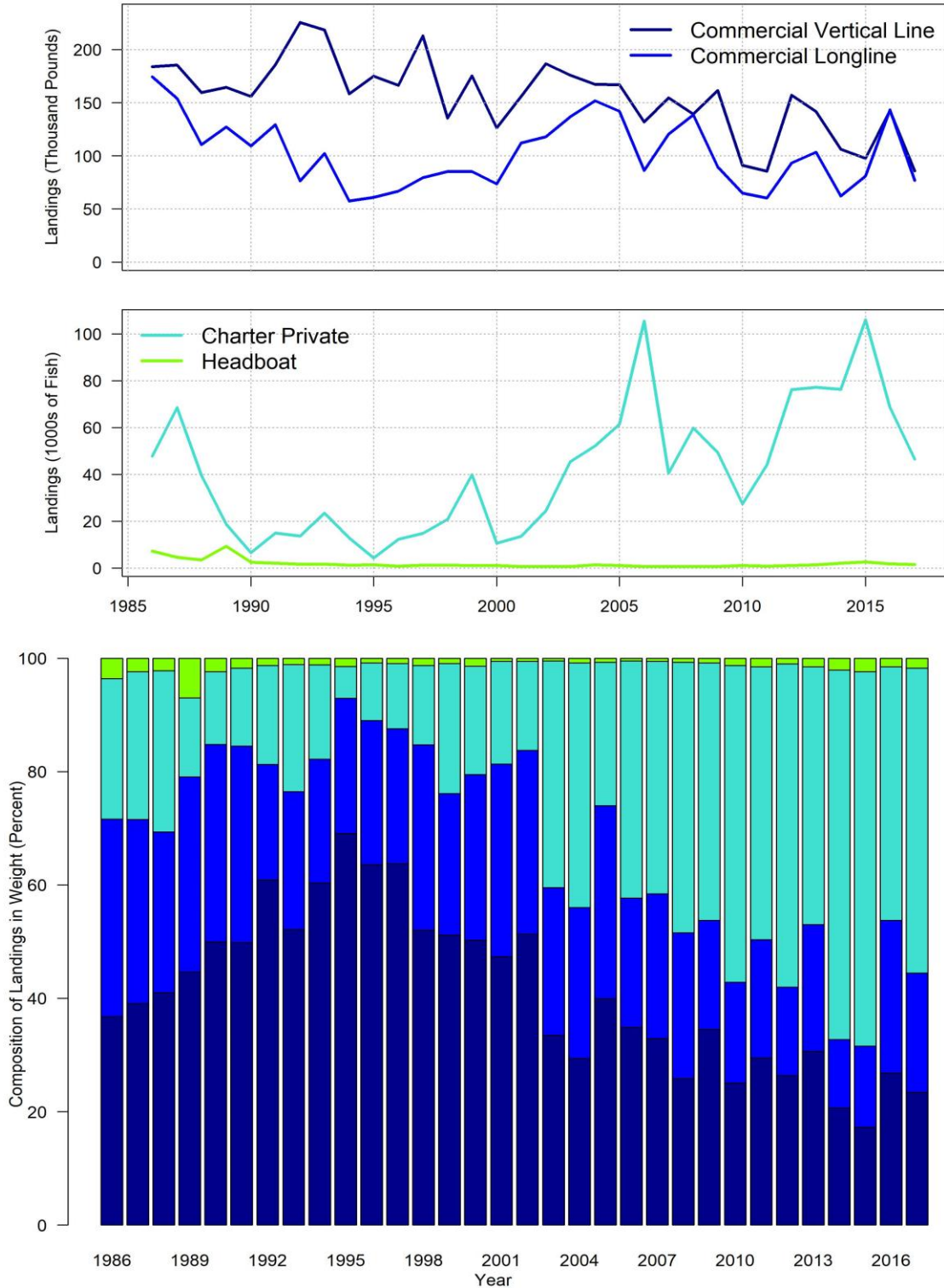

Figure RW4. Observed landings by fleet and by proportion (by weight based on expected landings in SS) for Gulf of Mexico Scamp. Commercial landings are shown in thousands of pounds but input into the SEDAR 68 RW Base Model in units of metric tons. Recreational landings are shown and input in numbers (1,000s of fish) into the SEDAR 68 RW Base Model.

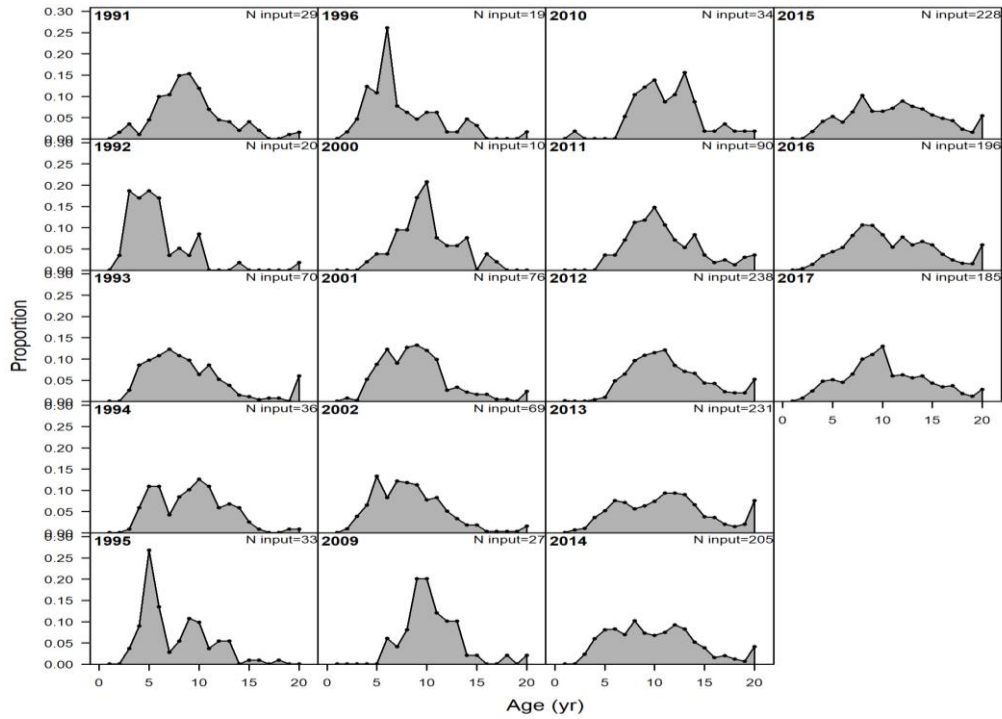

Figure RW5A. Observed age composition data for Gulf of Mexico Scamp retained by the Commercial Vertical Line fleet in the SEDAR 68 RW Base Model. Note that the SEDAR 68 AP Base Model input conditional age-at-length data for the commercial fleets.

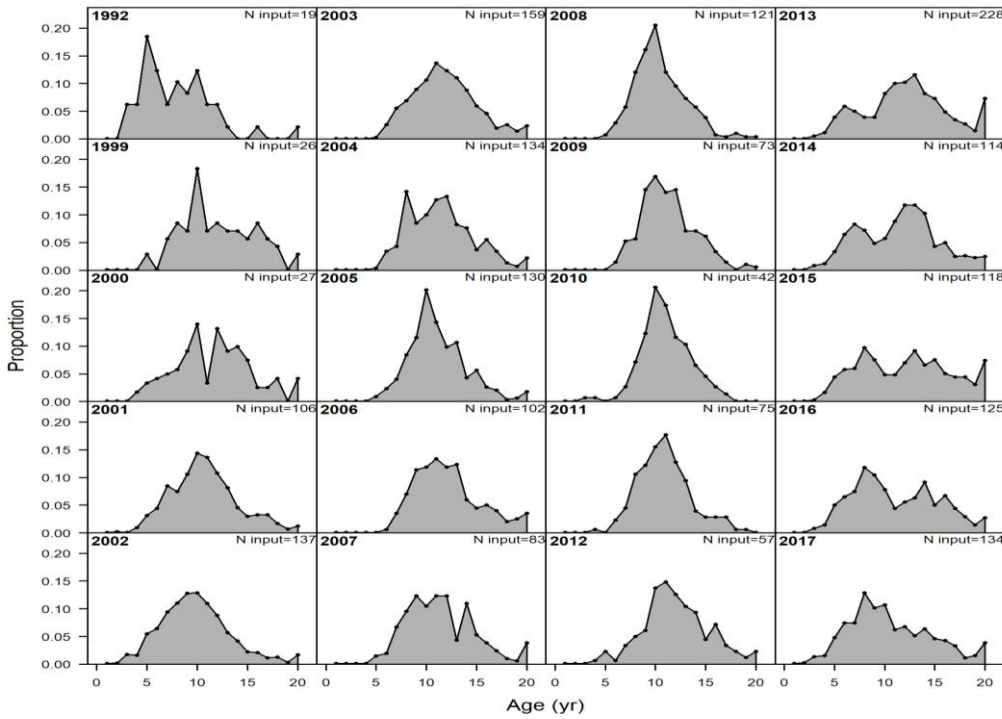

Figure RW5B. Observed age composition data for Gulf of Mexico Scamp retained by the Commercial Longline fleet in the SEDAR 68 RW Base Model. Note that the SEDAR 68 AP Base Model input conditional age-at-length data for the commercial fleets.

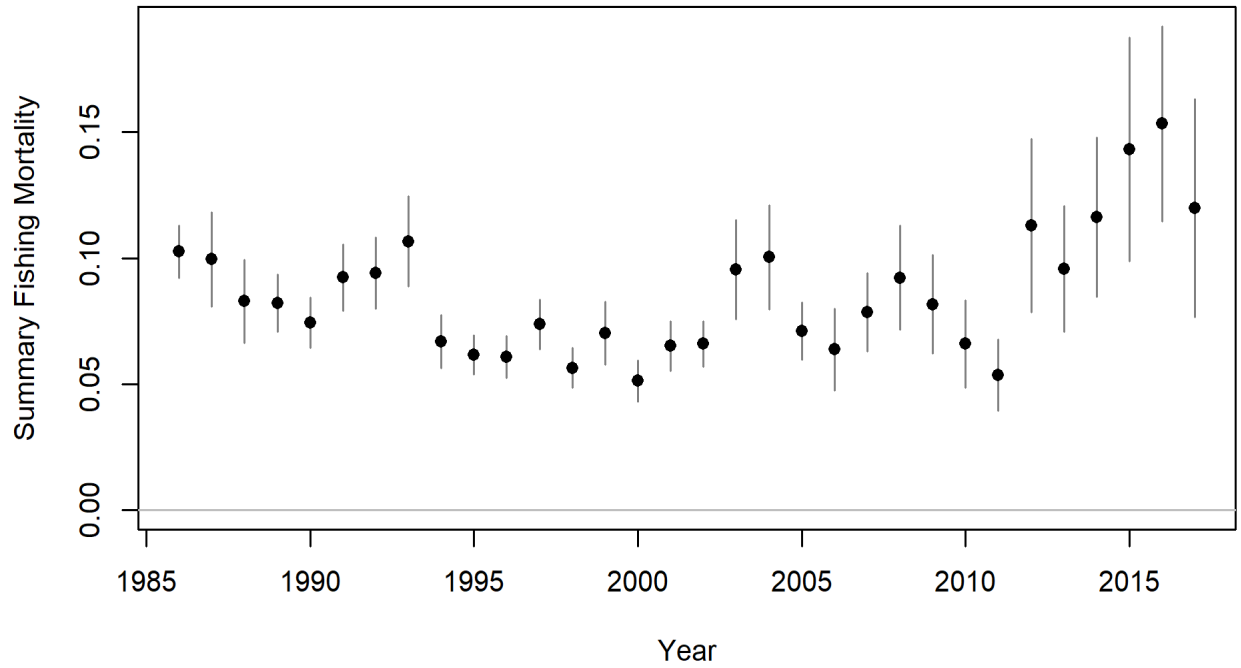

Figure RW11. Annual exploitation rate (total biomass killed age 3+ / total biomass age 3+) for Gulf of Mexico Scamp.

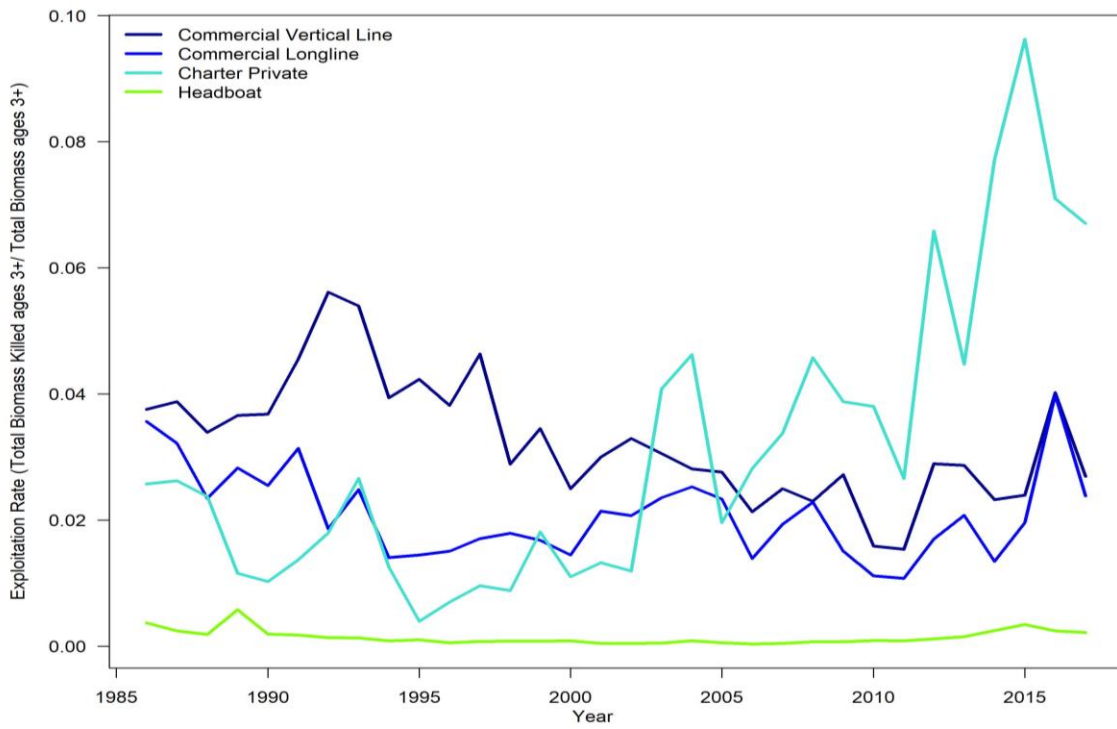

Figure RW12. Annual exploitation rate (total biomass killed age 3+ / total biomass age 3+) by fleet for Gulf of Mexico Scamp.

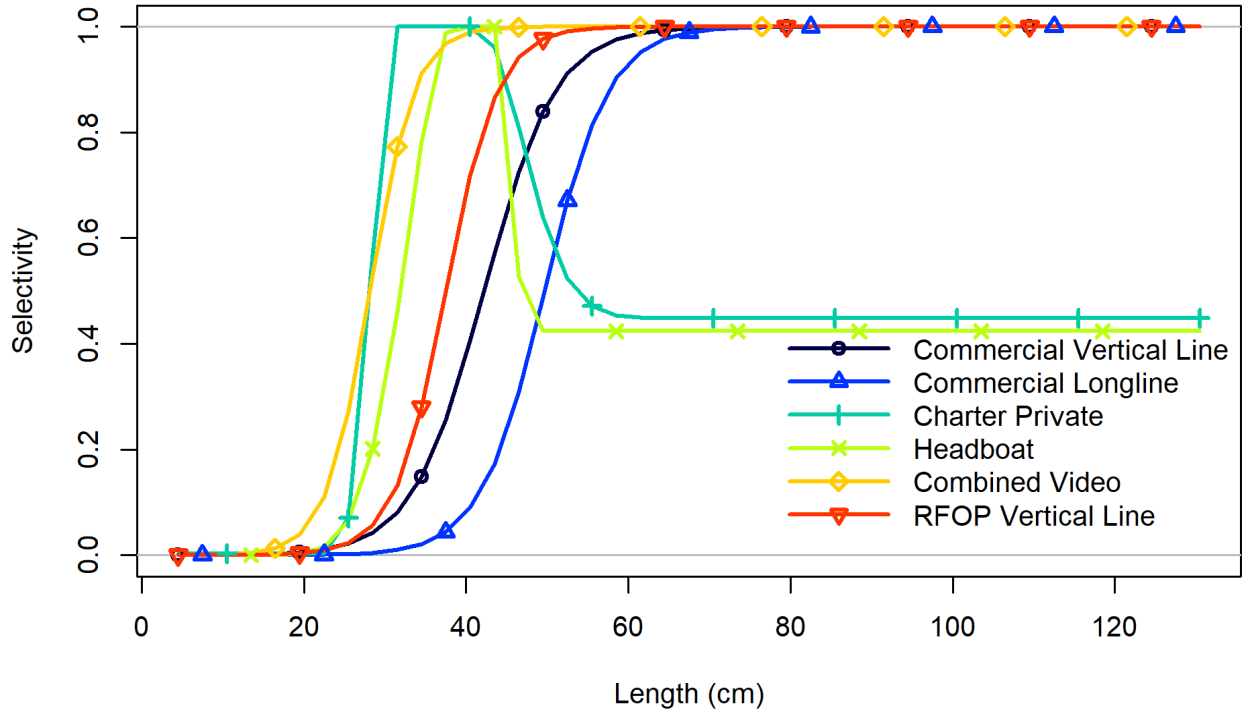

Figure RW13. Length-based selectivity for each fleet and survey for Gulf of Mexico Scamp in the terminal year of the assessment, 2017.

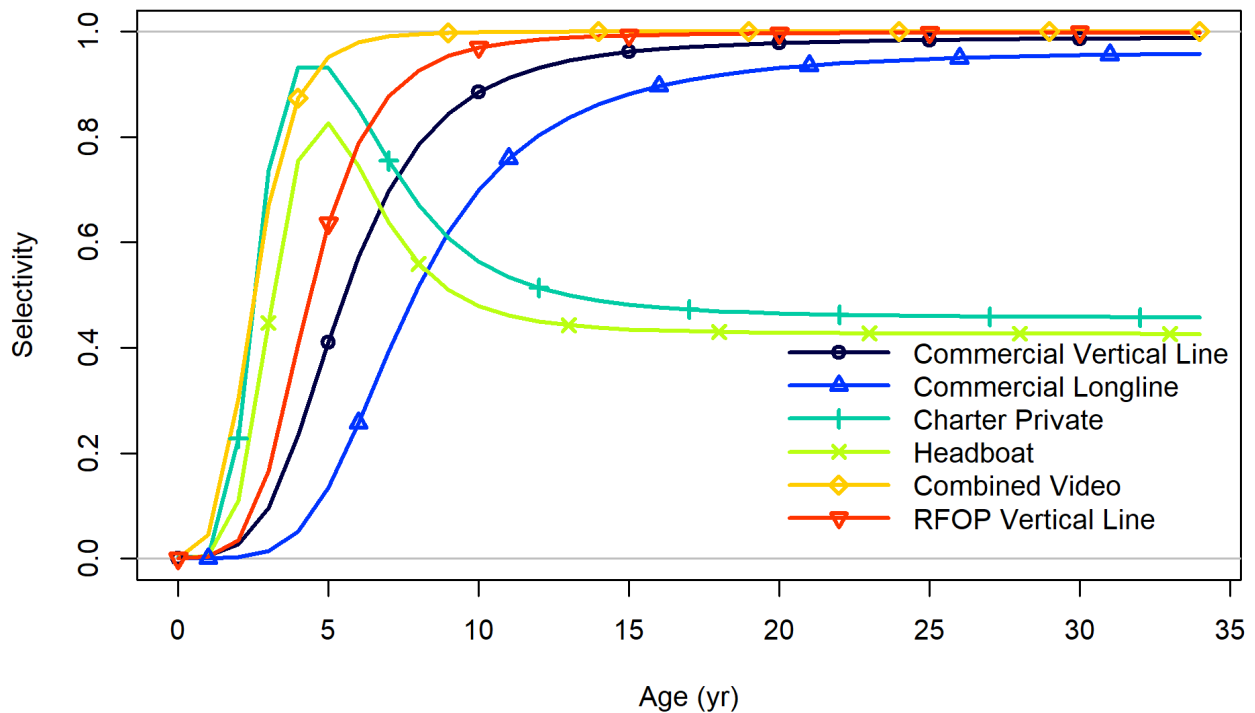

Figure RW14. Derived age-based selectivity for each fleet and survey for Gulf of Mexico Scamp in the terminal year of the assessment, 2017.

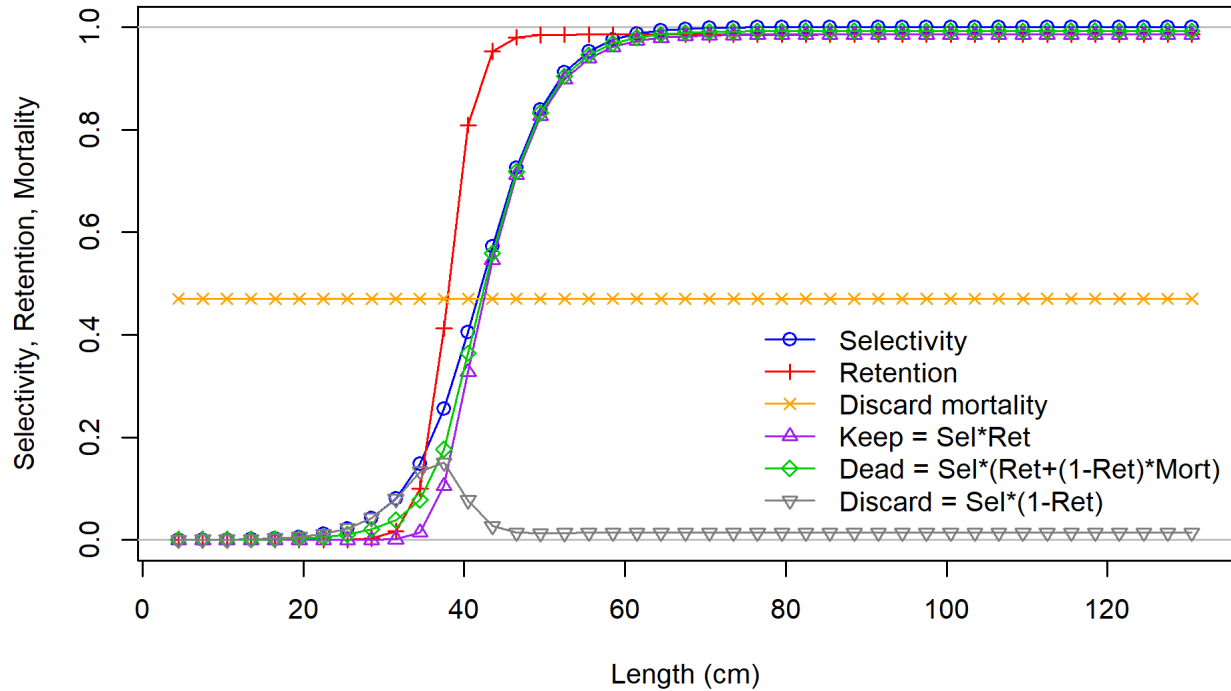

Figure RW15A. Length-based selectivity and retention for the Commercial Vertical Line fleet in the terminal year of the assessment, 2017. Selectivity (blue line) is constant over the entire assessment time period (1986 - 2017). Retention (red line) is shown for the most recent time period. Discard mortality (orange line) is constant at 0.47.

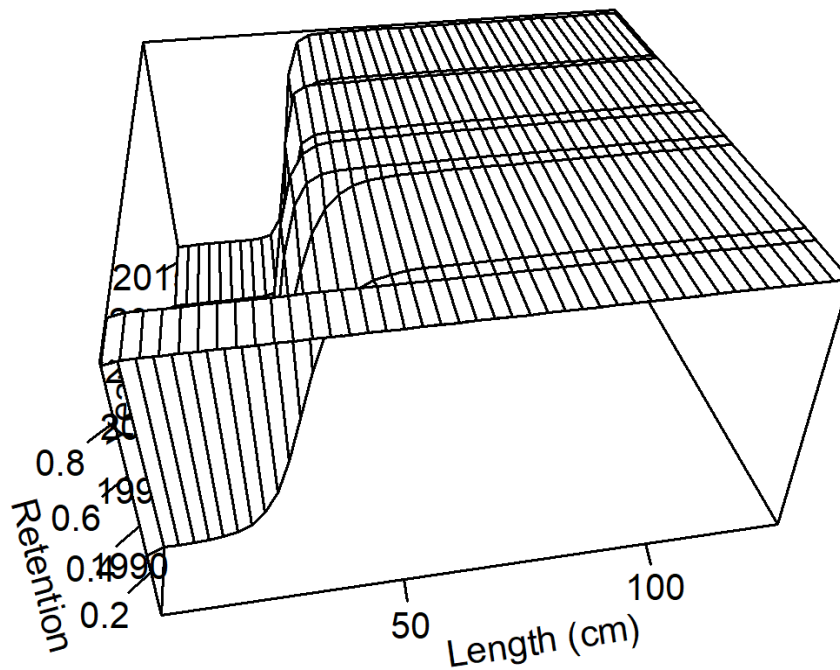

Figure RW15B. Time-varying retention at length for the Commercial Vertical Line fleet for Gulf of Mexico Scamp.

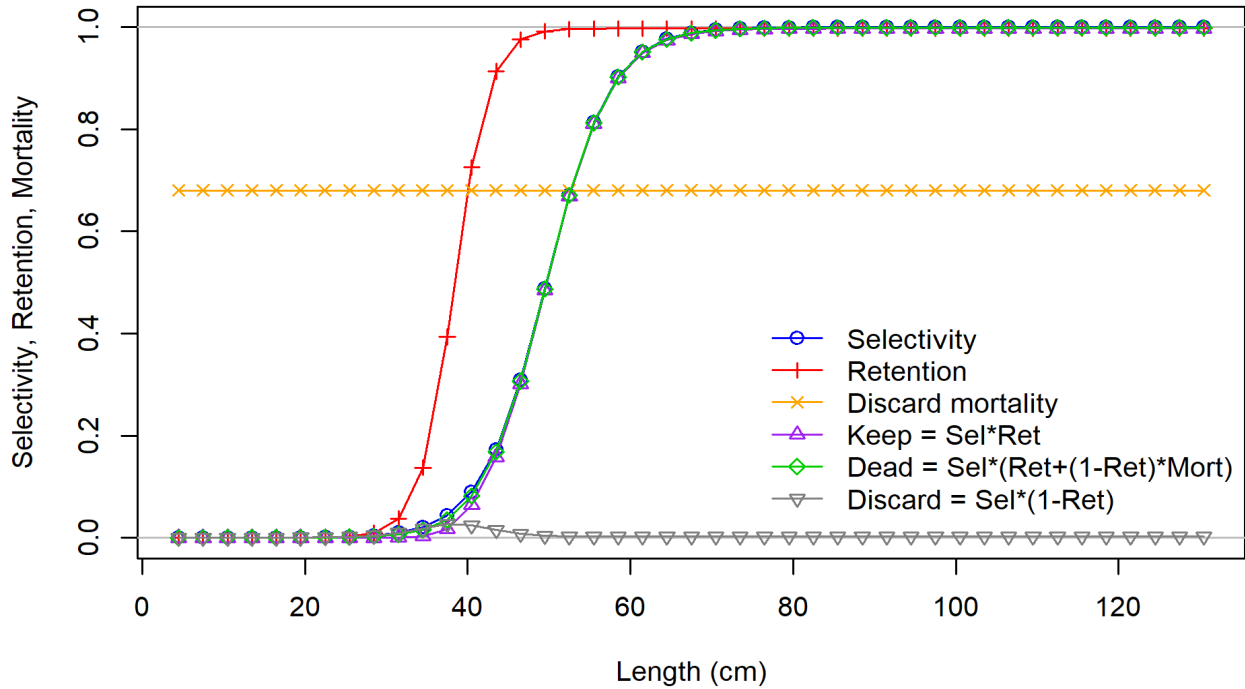

Figure RW15C. Length-based selectivity and retention for the Commercial Longline fleet in the terminal year of the assessment, 2017. Selectivity (blue line) is constant over the entire assessment time period (1986 - 2017). Retention (red line) is shown for the most recent time period. Discard mortality (orange line) is constant at 0.68.

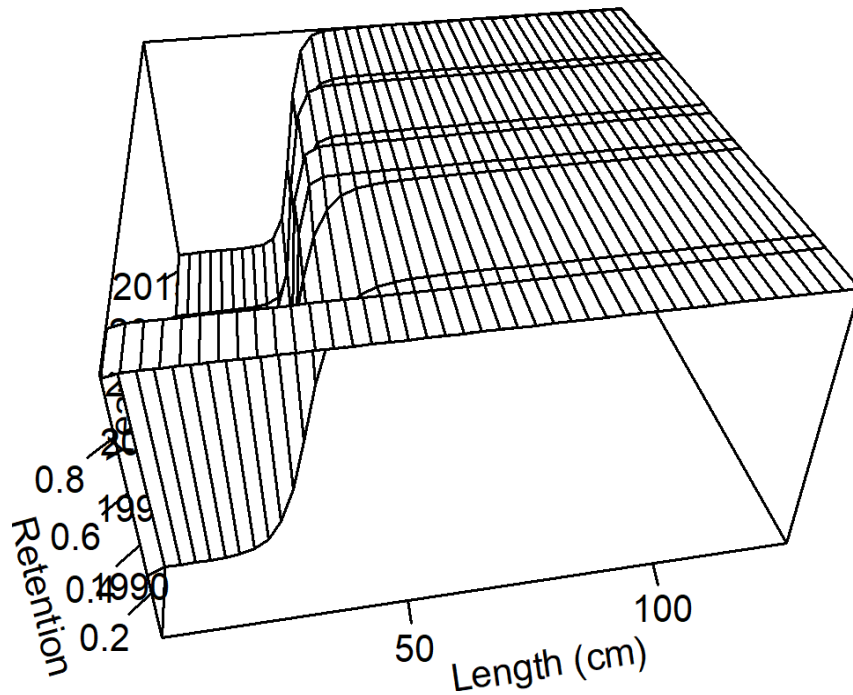

Figure RW15D. Time-varying retention at length for the Commercial Longline fleet for Gulf of Mexico Scamp.

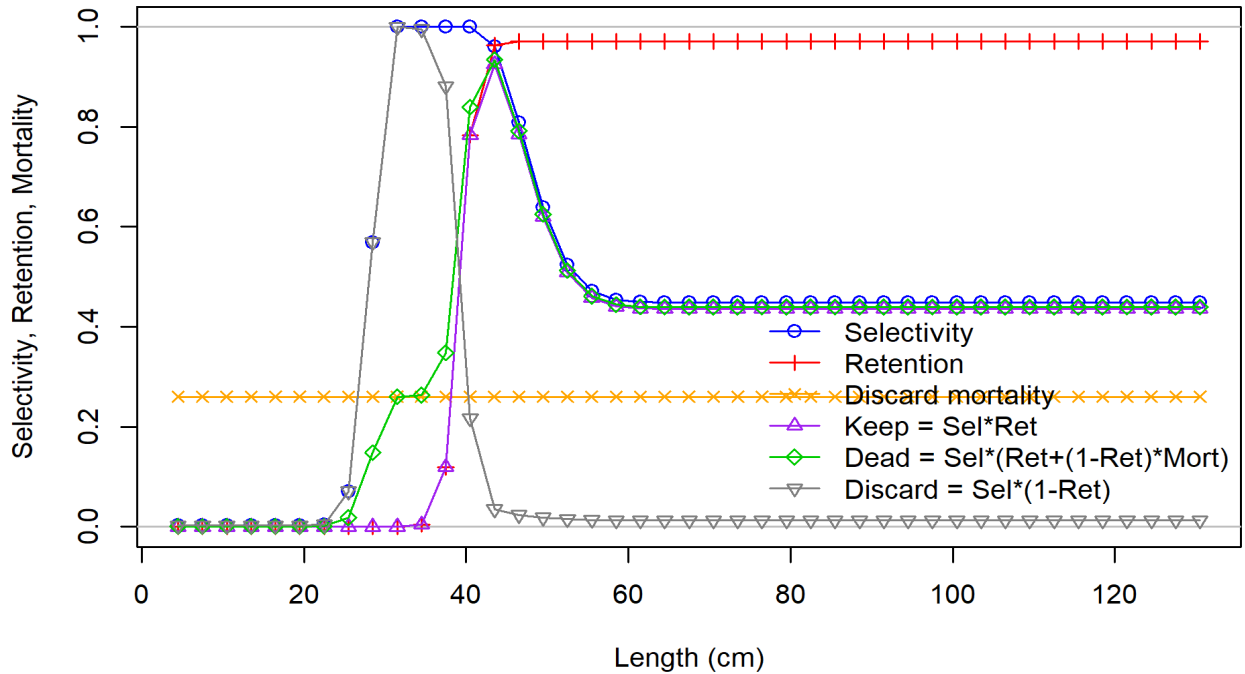

Figure RW16A. Length-based selectivity and retention for the Recreational Charter Private fleet in the terminal year of the assessment, 2017. Selectivity (blue line) is constant over the entire assessment time period (1986 - 2017). Retention (red line) is shown for the most recent time period. Discard mortality (orange line) is constant at 0.26.

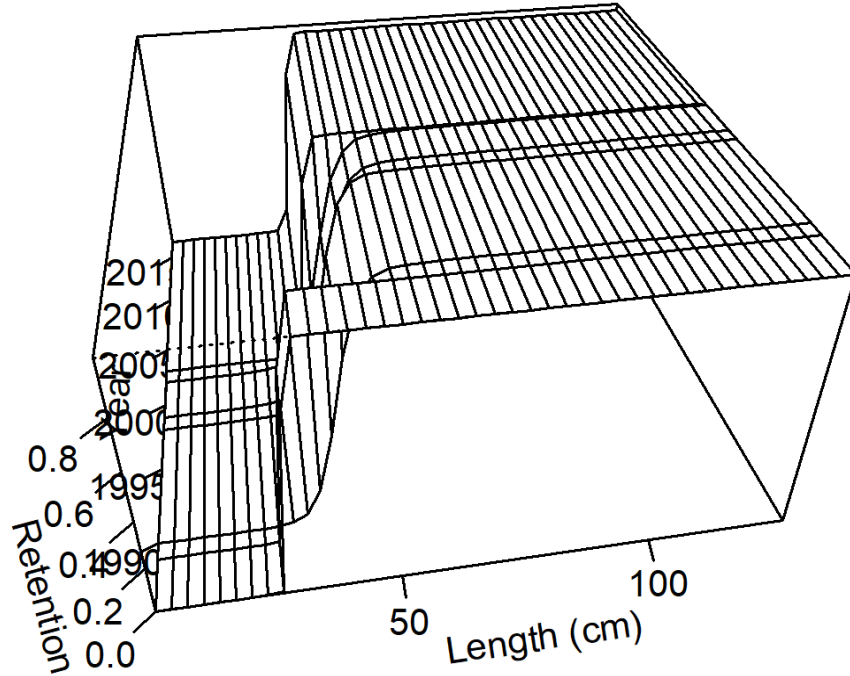

Figure RW16B. Time-varying retention at length for the Recreational Charter Private fleet for Gulf of Mexico Scamp.

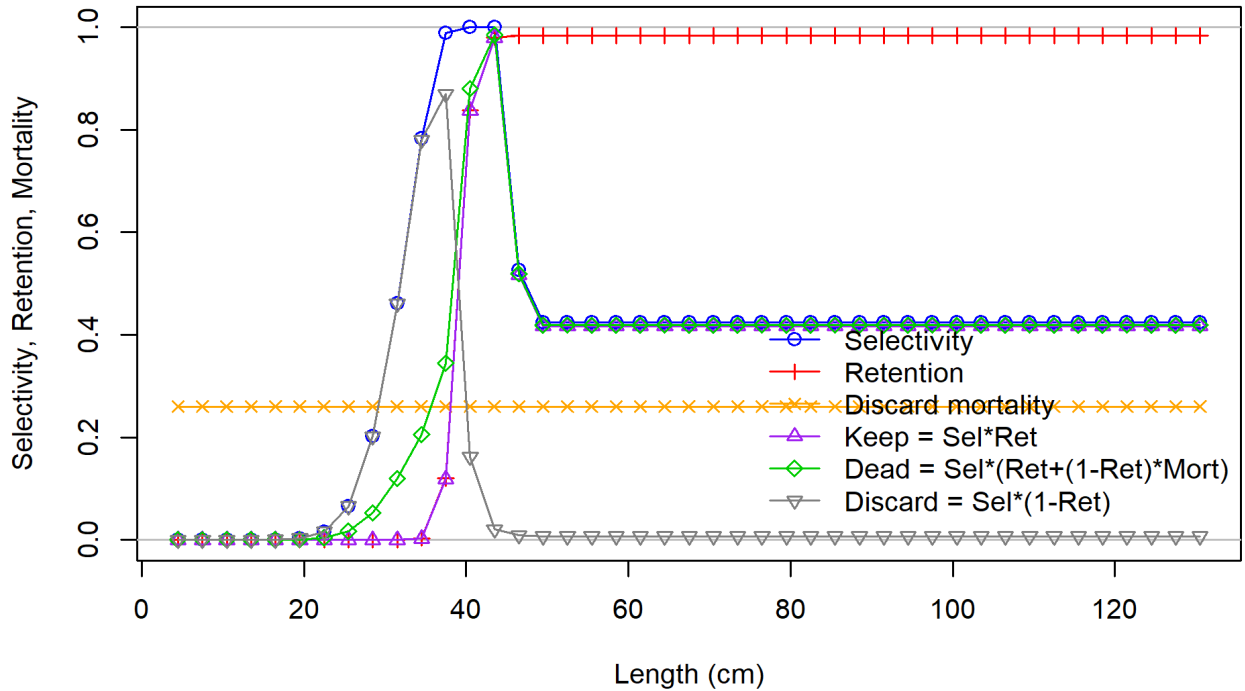

Figure RW16C. Length-based selectivity and retention for the Recreational Headboat fleet in the terminal year of the assessment, 2017. Selectivity (blue line) is constant over the entire assessment time period (1986 - 2017). Retention (red line) is shown for the most recent time period. Discard mortality (orange line) is constant at 0.26.

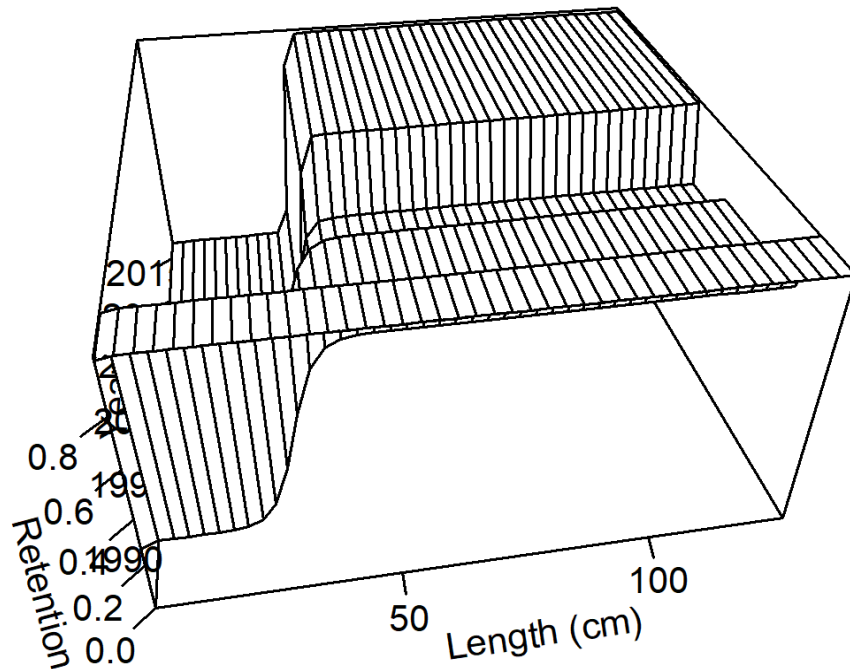

Figure RW16D. Time-varying retention at length for the Recreational Headboat fleet for Gulf of Mexico Scamp.

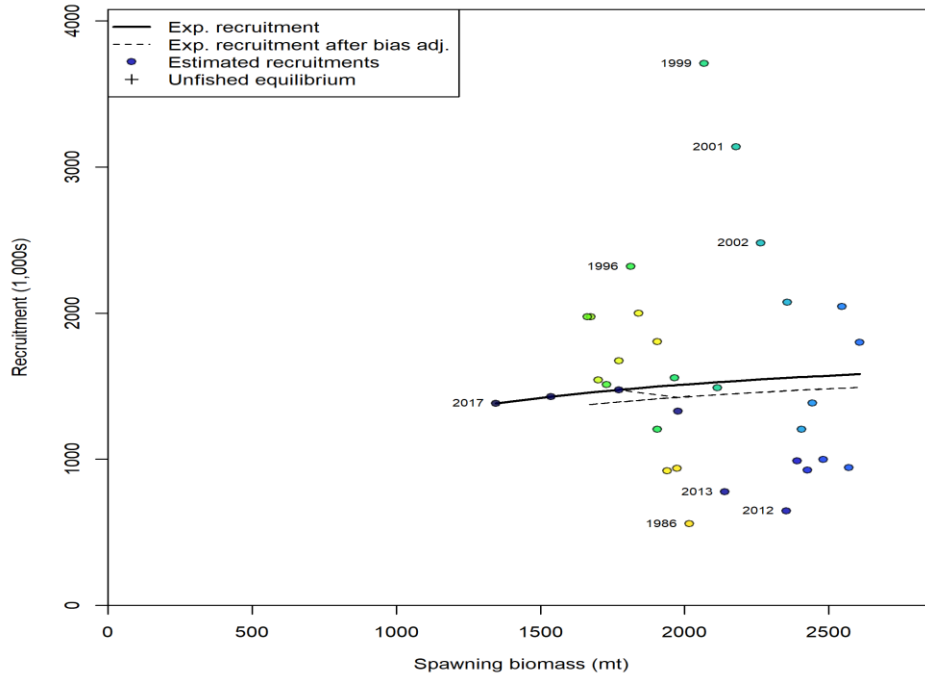

Figure RW17. Expected stock-recruitment relationship for Gulf of Mexico Scamp. Steepness was fixed at 0.6935 and σ_R was estimated at 0.445 (0.128). Plotted are expected annual recruitments from SS (circles), expected recruitment from the stock-recruit relationship (black line), and bias adjusted recruitment from the stock-recruit relationship (dashed line).

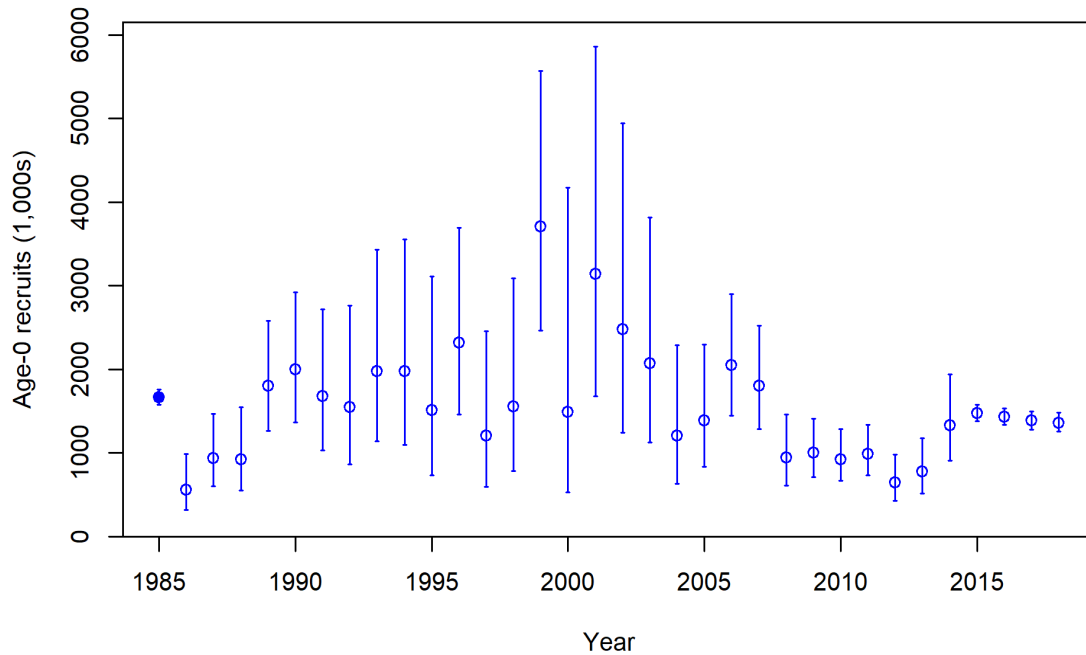

Figure RW18. Estimated Age-0 recruitment with ~95% asymptotic intervals for Gulf of Mexico Scamp. Steepness was fixed at 0.6935 and σ_R was estimated at 0.445 (0.128).

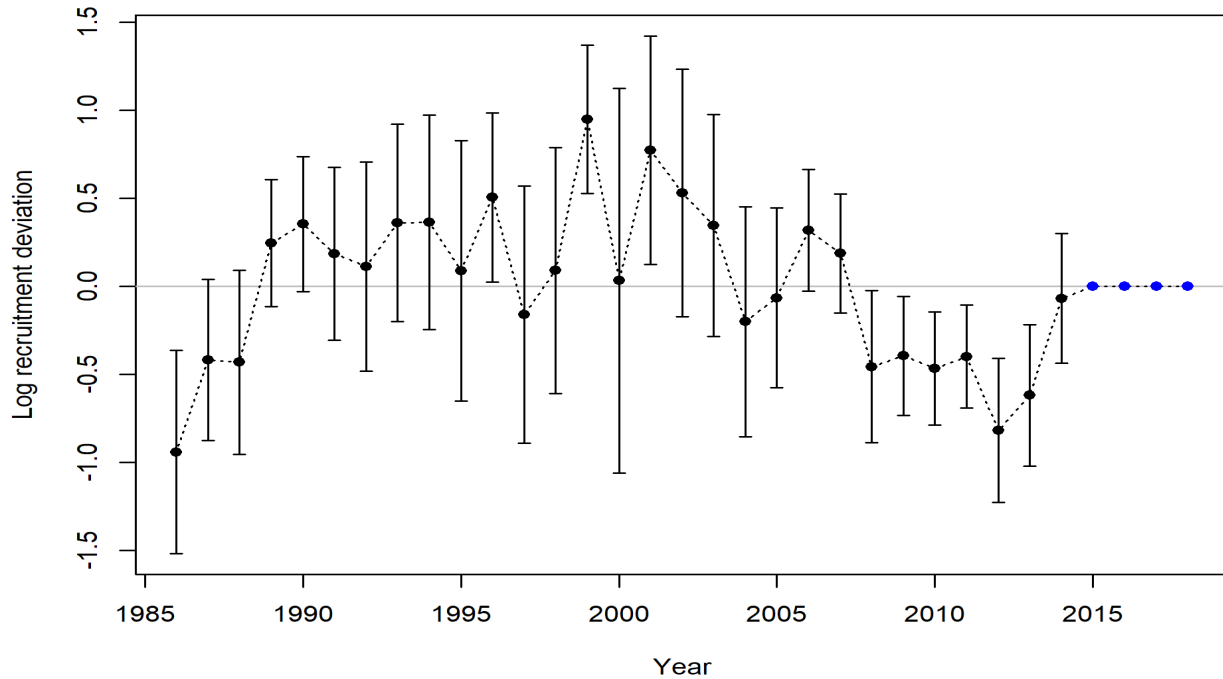

Figure RW19. Estimated log-scale recruitment deviations with 95% confidence intervals for Gulf of Mexico Scamp. Steepness was fixed at 0.6935 and sigmaR was estimated at 0.445 (0.128).

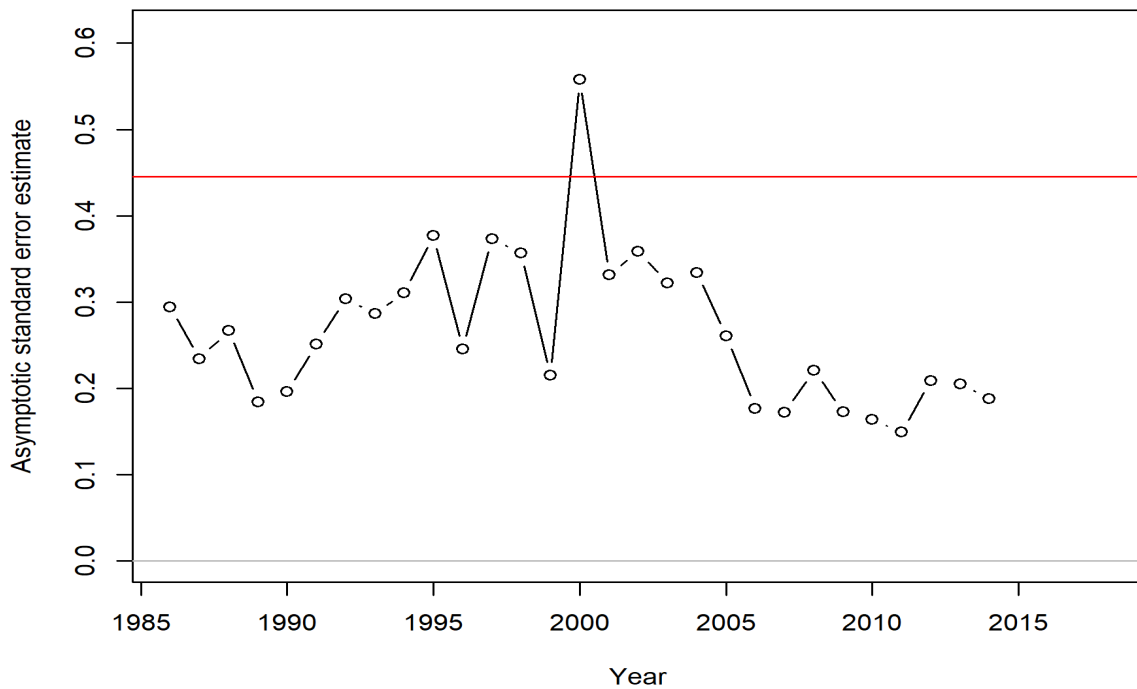

Figure RW20. Asymptotic standard errors for recruitment deviations for Gulf of Mexico Scamp. Steepness was fixed at 0.6935 and sigmaR was estimated at 0.445 (0.128).

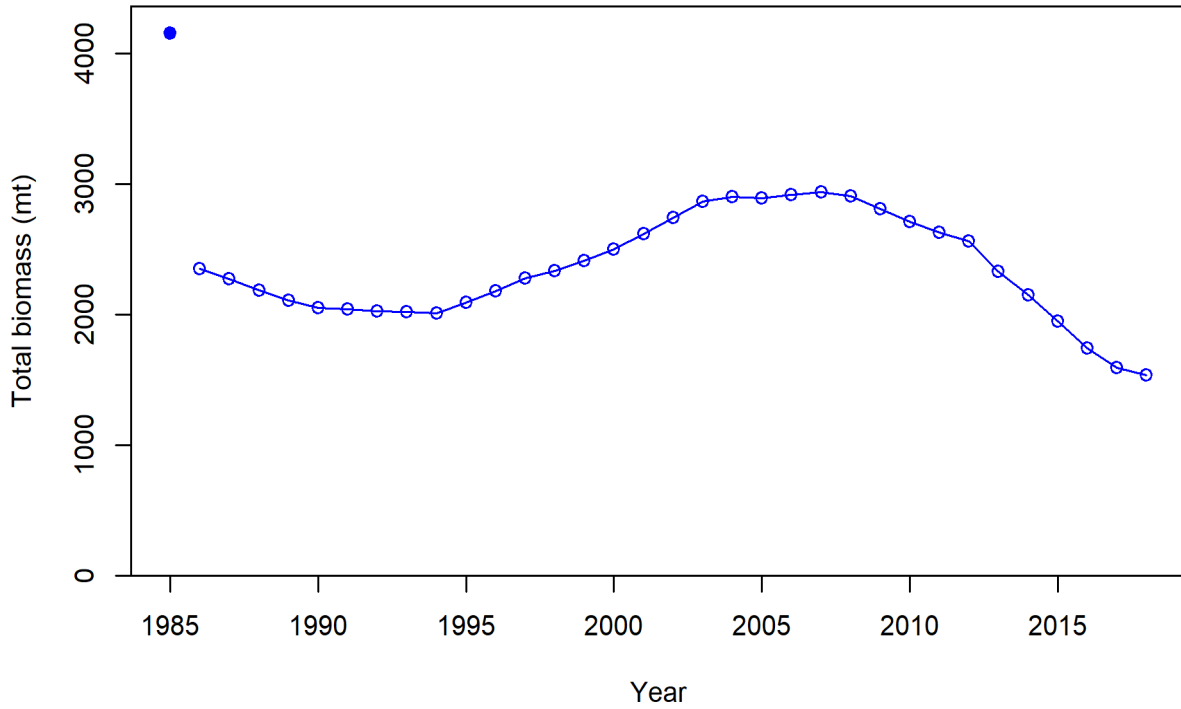

Figure RW21. Estimate of total biomass (metric tons) for Gulf of Mexico Scamp.

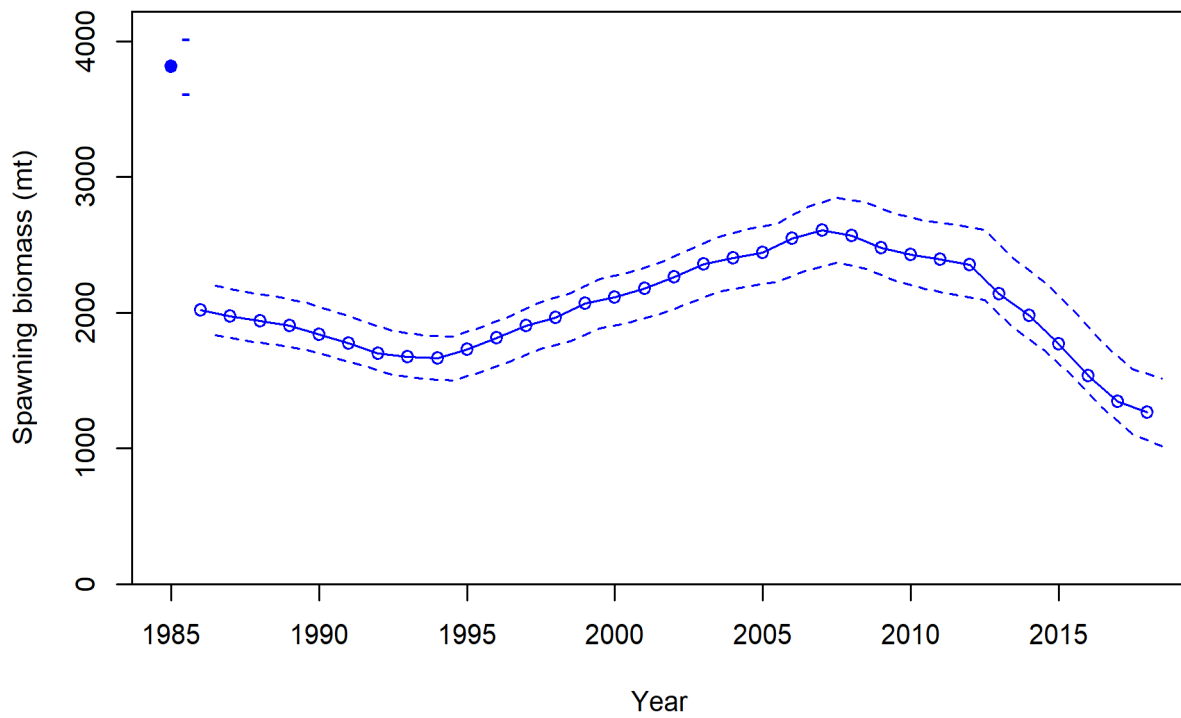

Figure RW22. Estimate of spawning stock biomass (metric tons) with ~95% asymptotic intervals for Gulf of Mexico Scamp.

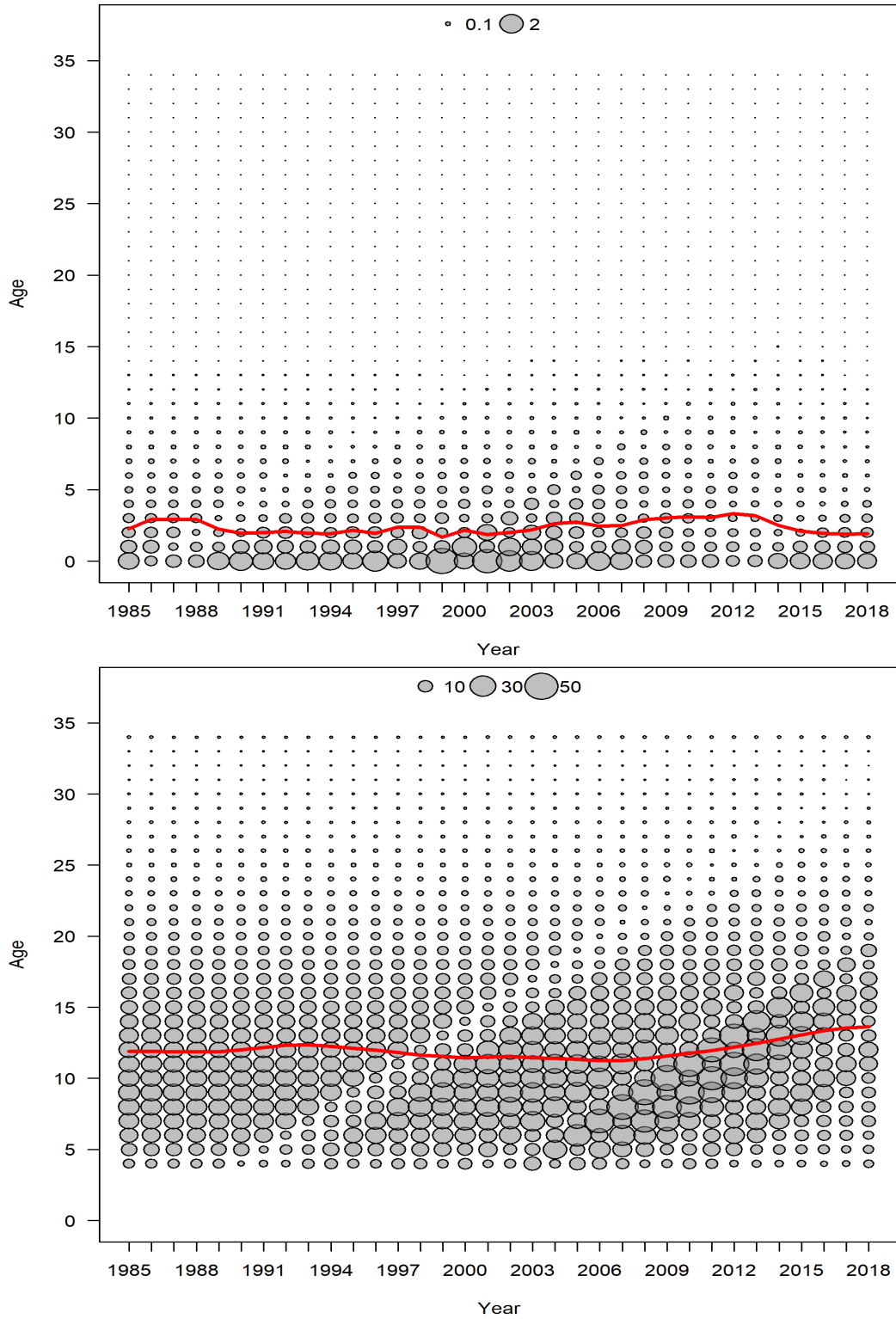

Figure RW23A. Expected numbers-at-age (bubbles) and mean age (red line) of female (top; millions of fish) and male (bottom; thousands of fish) Gulf of Mexico Scamp.

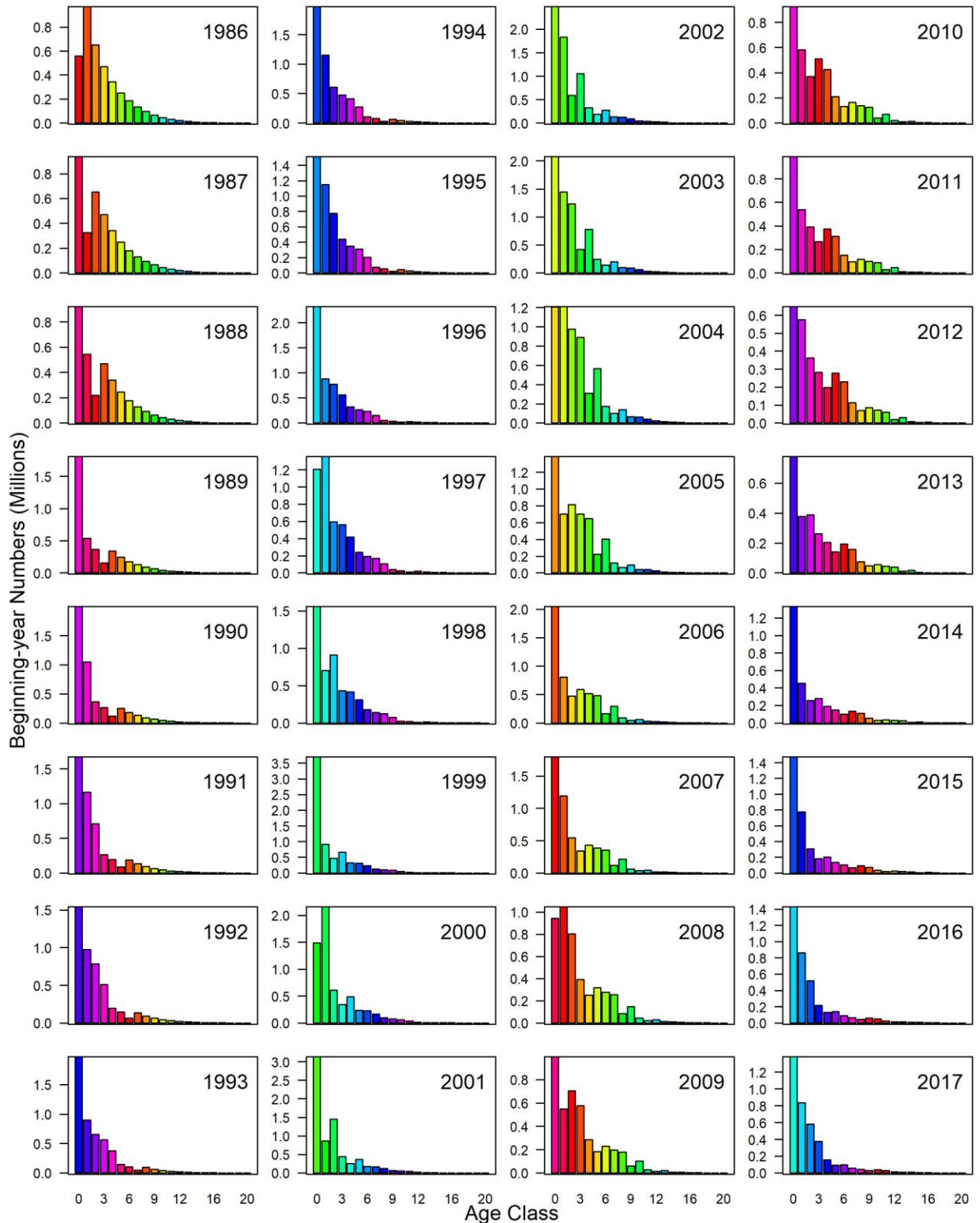

Figure RW23B. Expected numbers-at-age (millions) at the beginning of each year (January 1st) for female Scamp in the Gulf of Mexico. Note that y-axes differ between panels and colors track cohorts across years.

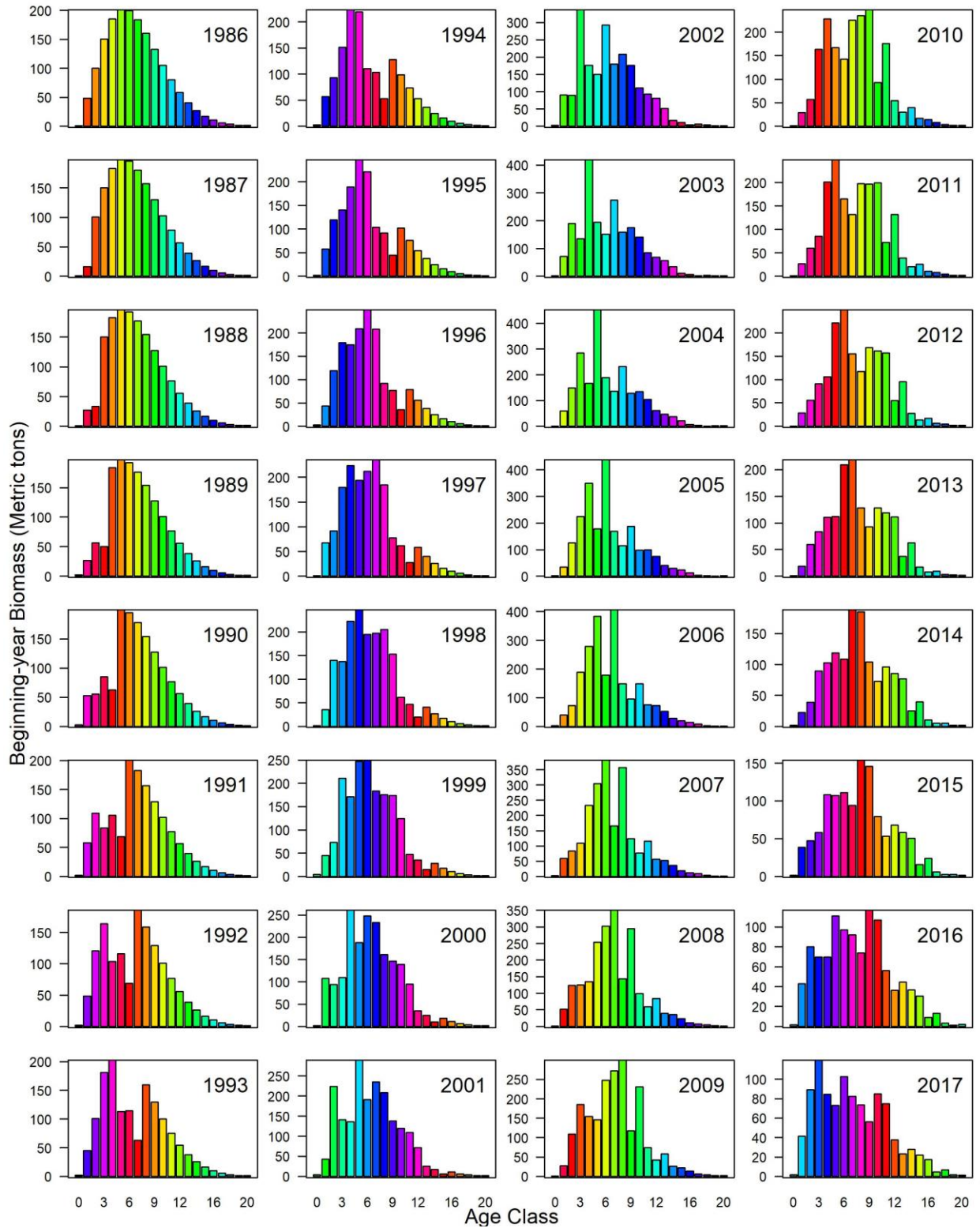

Figure RW23C. Expected biomass-at-age (metric tons) at the beginning of each year (January 1st) for female Scamp in the Gulf of Mexico. Note that y-axes differ between panels and colors track cohorts across years.

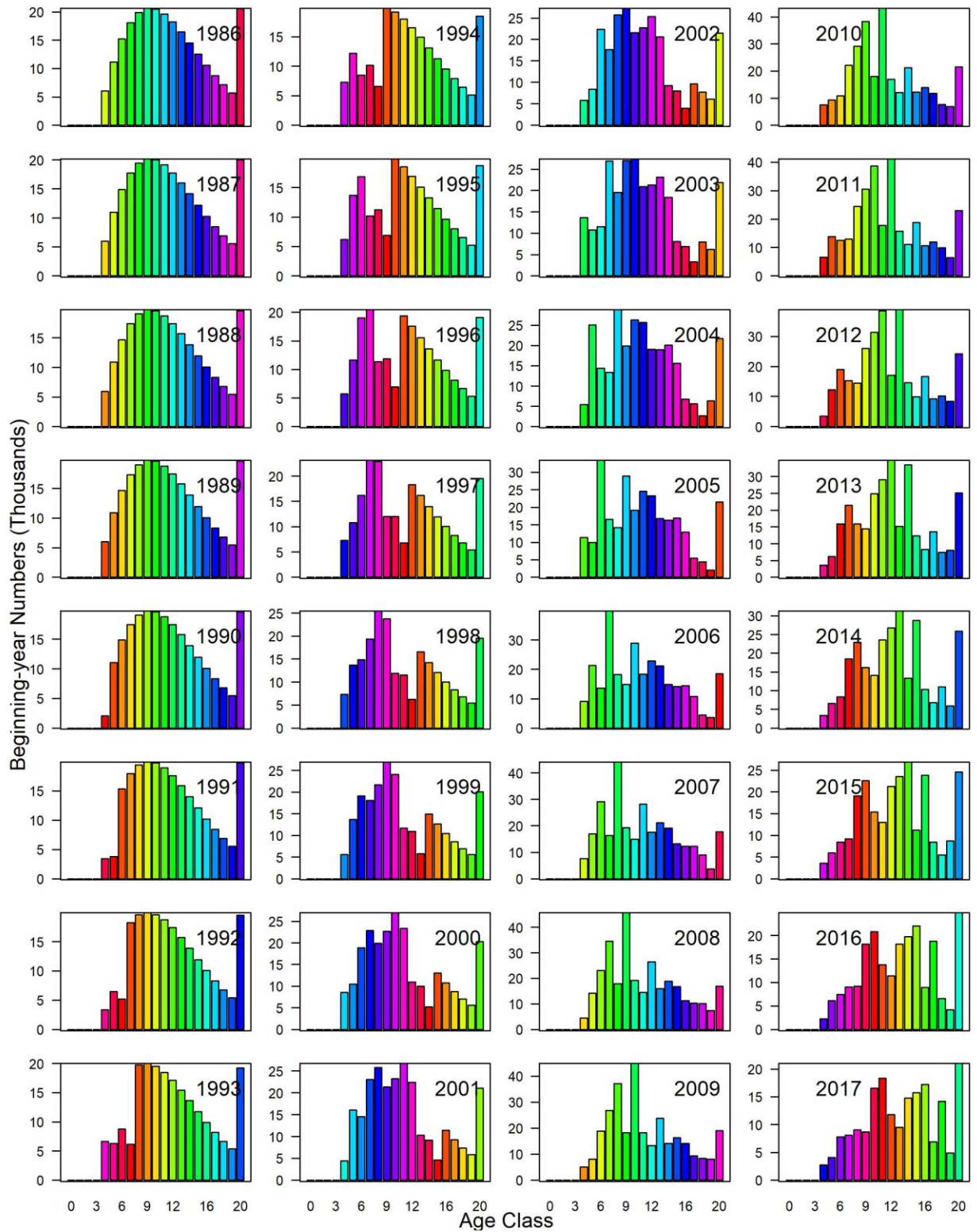

Figure RW23D. Expected numbers-at-age (thousands) at the beginning of each year (January 1st) for male Scamp in the Gulf of Mexico. Note that y-axes differ between panels and colors track cohorts across years.

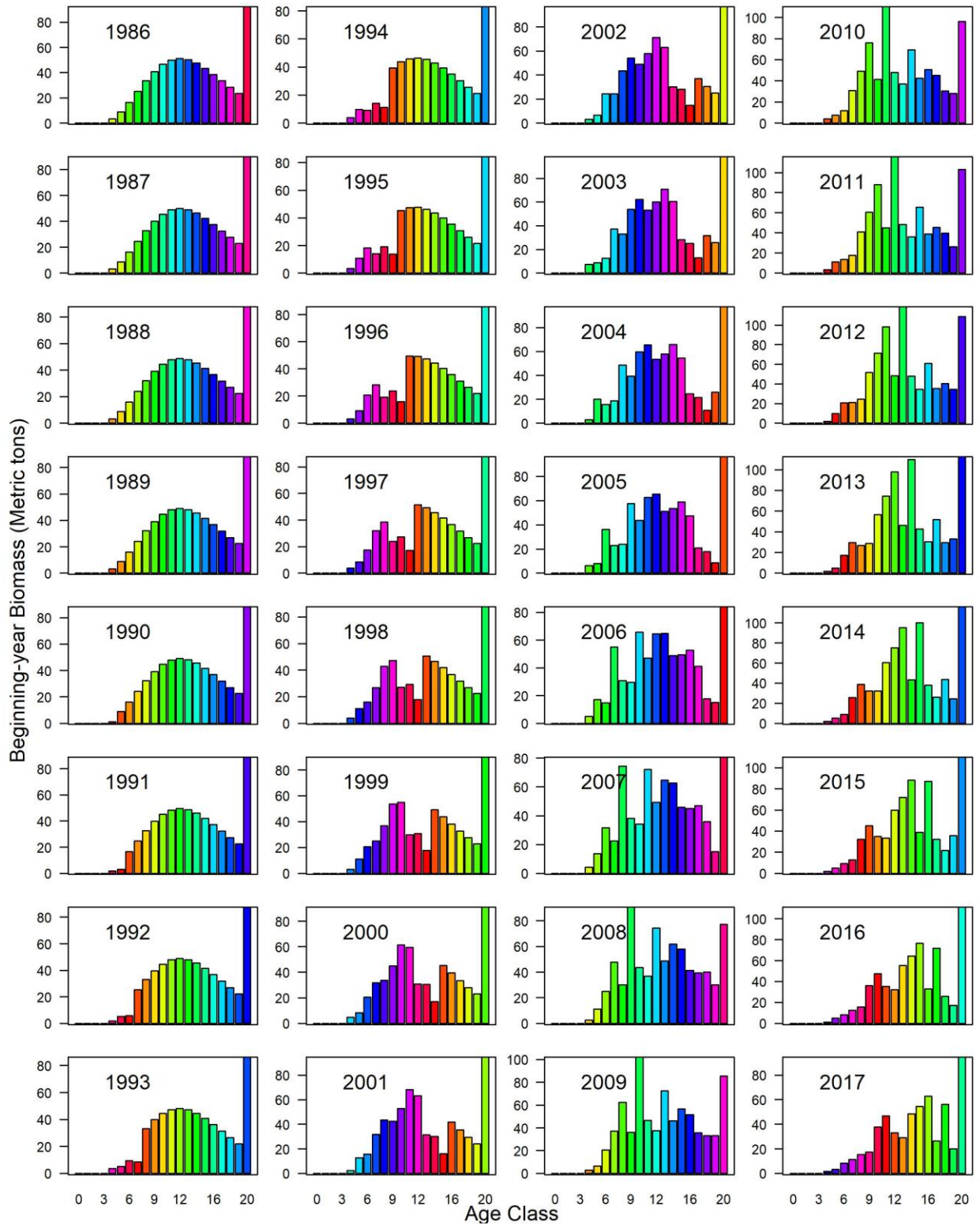

Figure RW23E. Expected biomass-at-age (metric tons) at the beginning of each year (January 1st) for male Scamp in the Gulf of Mexico. Note that y-axes differ between panels and colors track cohorts across years.

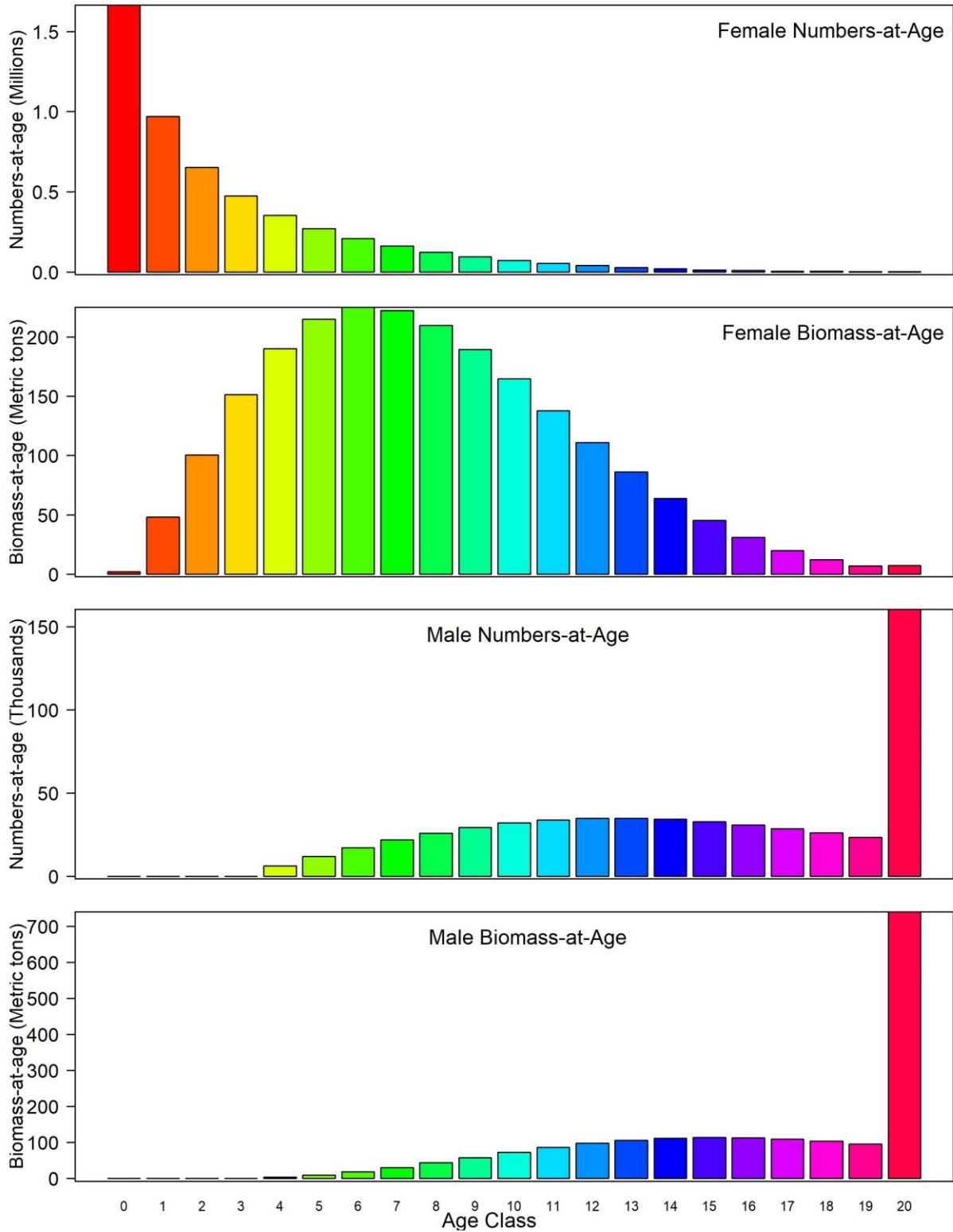

Figure RW24. Expected numbers-at-age and biomass-at-age for female and male Scamp in the Gulf of Mexico at virgin stock conditions.

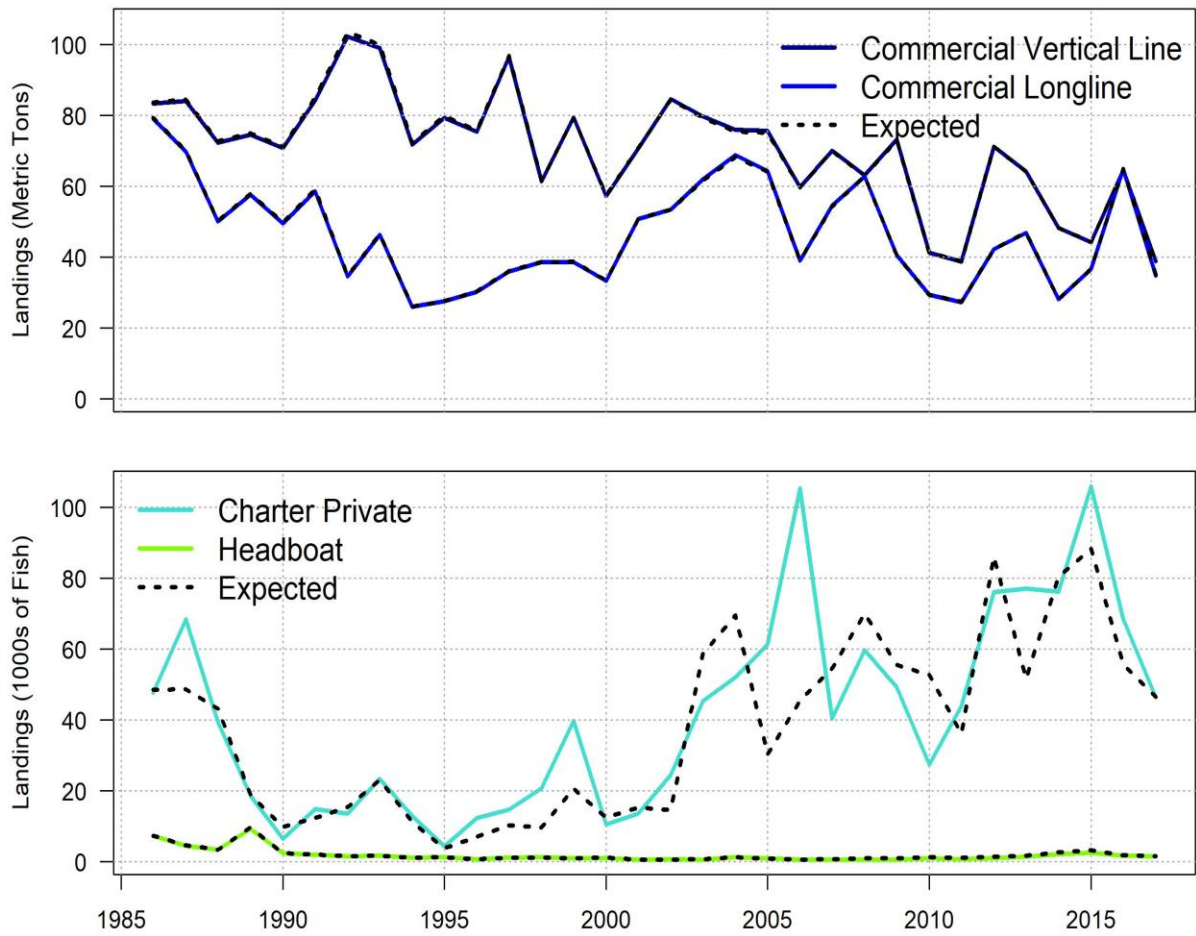

Figure RW25. Gulf of Mexico Scamp input (thick colored lines) and expected (dashed lines) landings by fleet. Commercial landings were input into the model as metric tons in gutted weight, and are shown in thousands of pounds. Recreational landings were input into the model as numbers (1,000 of fish). Associated log-scale standard errors are provided in Tables RW16-19.

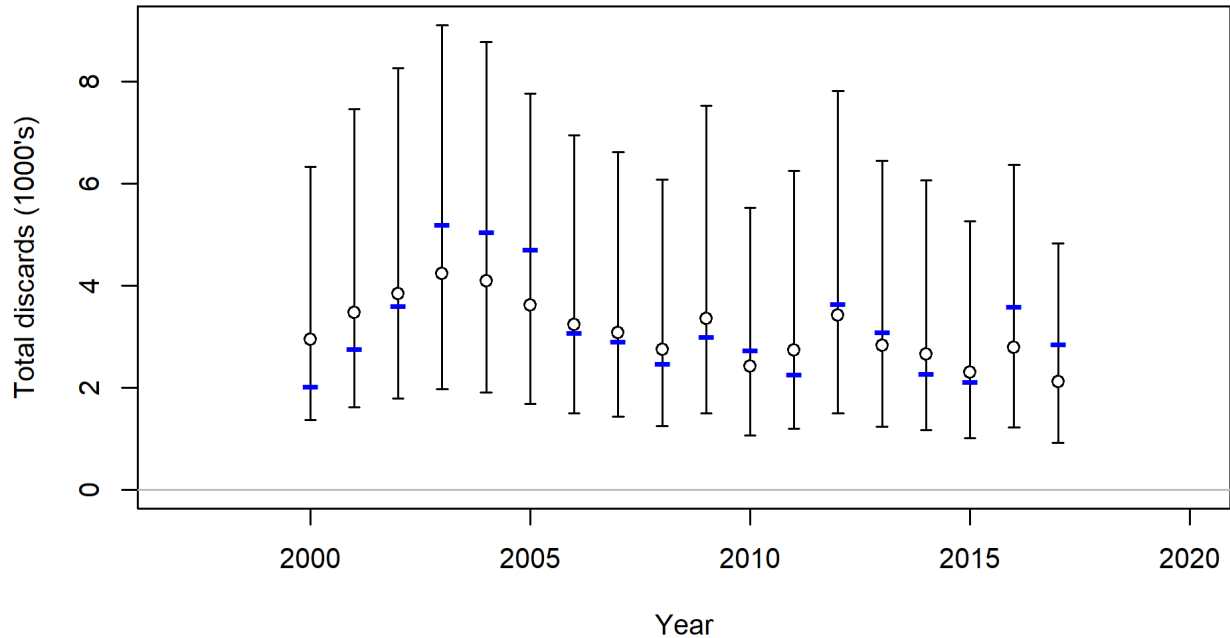

Figure RW26A. Input (dots with 95% confidence intervals) and expected (blue lines) discards by the Commercial Vertical Line fleet for Gulf of Mexico Scamp. Discards are in numbers of fish (1,000s) and reflect released fish (i.e., before discard mortality has been applied).

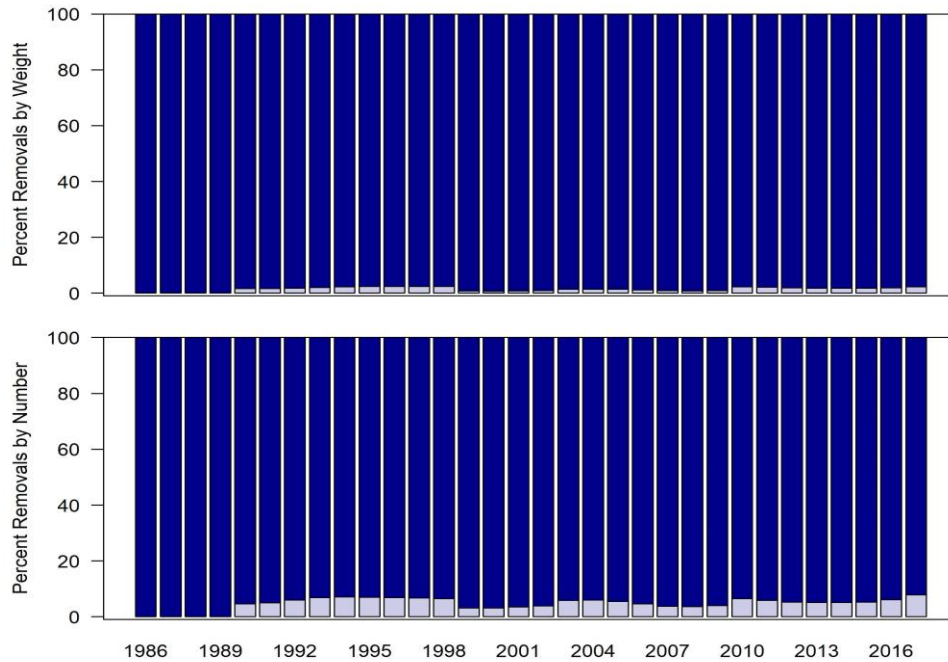

Figure RW26B. Comparison of landings (light bars) and dead discards (dark bars) for weights (top panel) and numbers of fish (bottom panel) for the Commercial Vertical Line fleet for Gulf of Mexico Scamp. Estimates of dead discards in both numbers and weights are provided in Table 20.

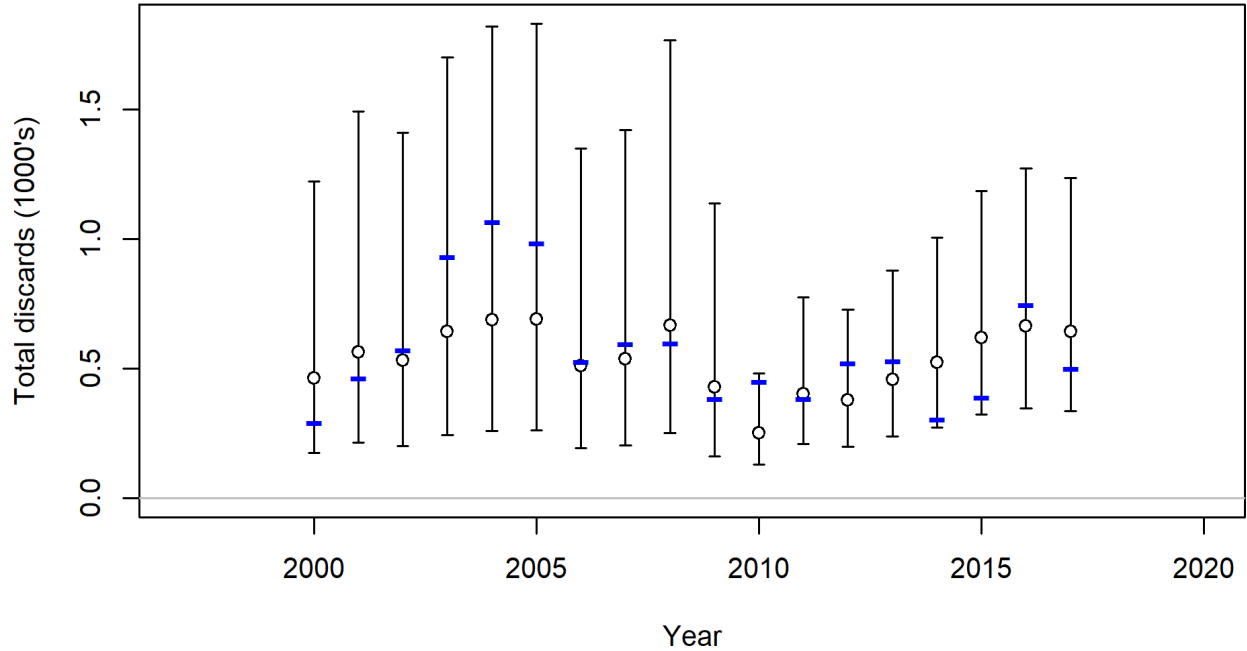

Figure RW26C. Input (dots with 95% confidence intervals) and expected (blue lines) discards by the Commercial Longline fleet for Gulf of Mexico Scamp. Discards are in numbers of fish (1,000's) and reflect released fish (i.e., before discard mortality has been applied).

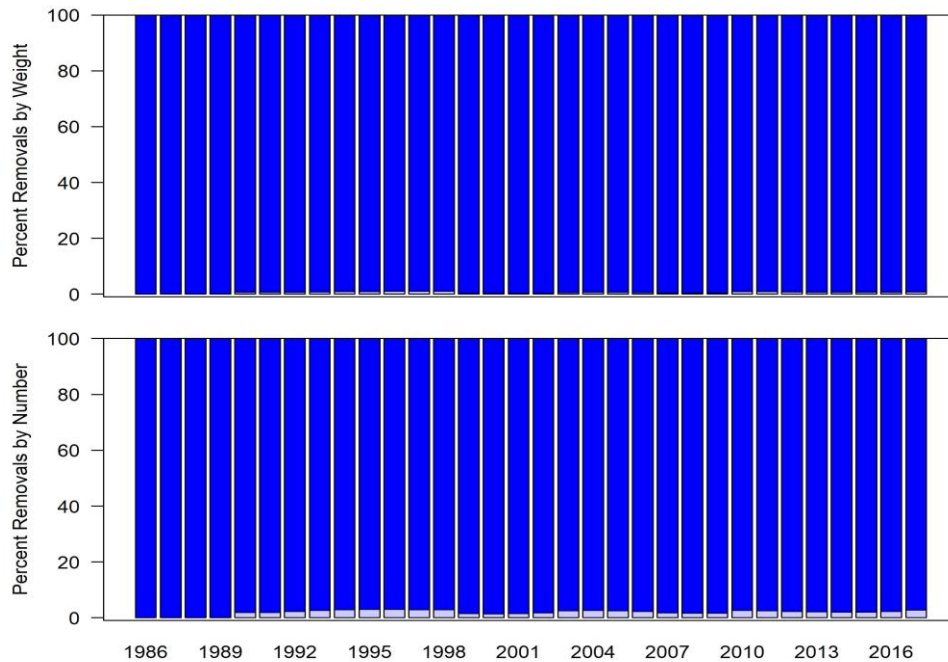

Figure RW26D. Comparison of landings (light bars) and dead discards (dark bars) for weights (top panel) and numbers of fish (bottom panel) for the Commercial Longline fleet for Gulf of Mexico Scamp. Estimates of dead discards in both numbers and weights are provided in Table 21.

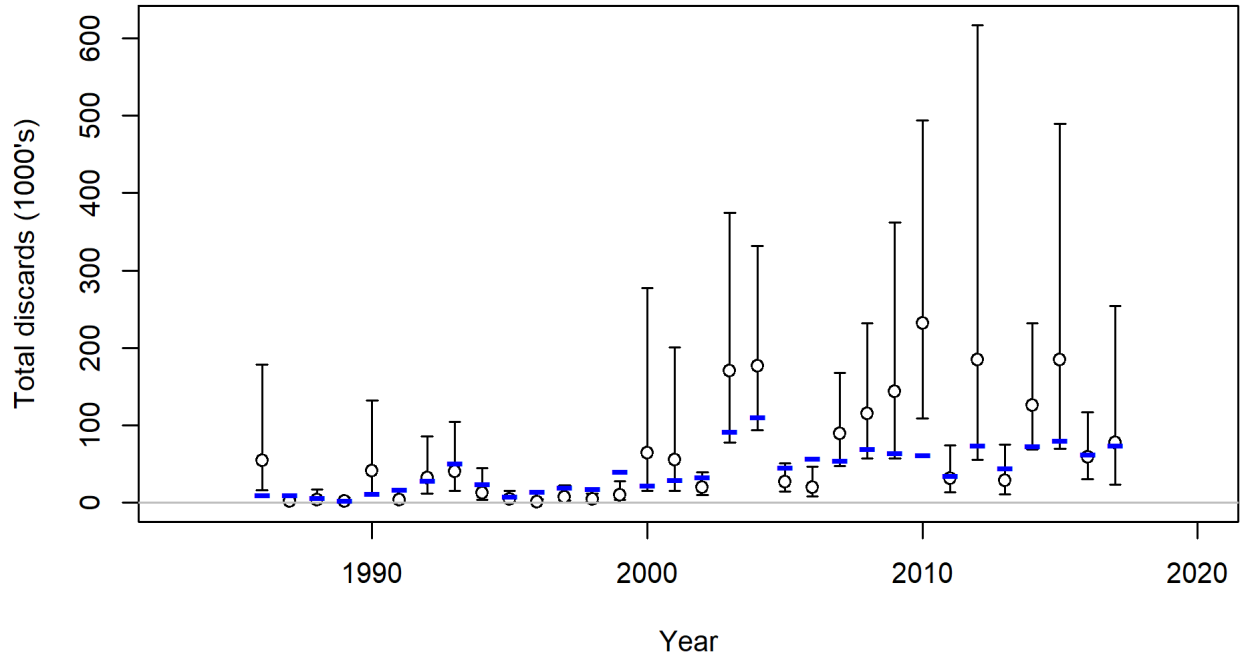

Figure RW27A. Input (dots with 95% confidence intervals) and expected (blue lines) discards by the Recreational Charter Private fleet for Gulf of Mexico Scamp. Discards are in numbers of fish (1,000s) and reflect released fish (i.e., before discard mortality has been applied).

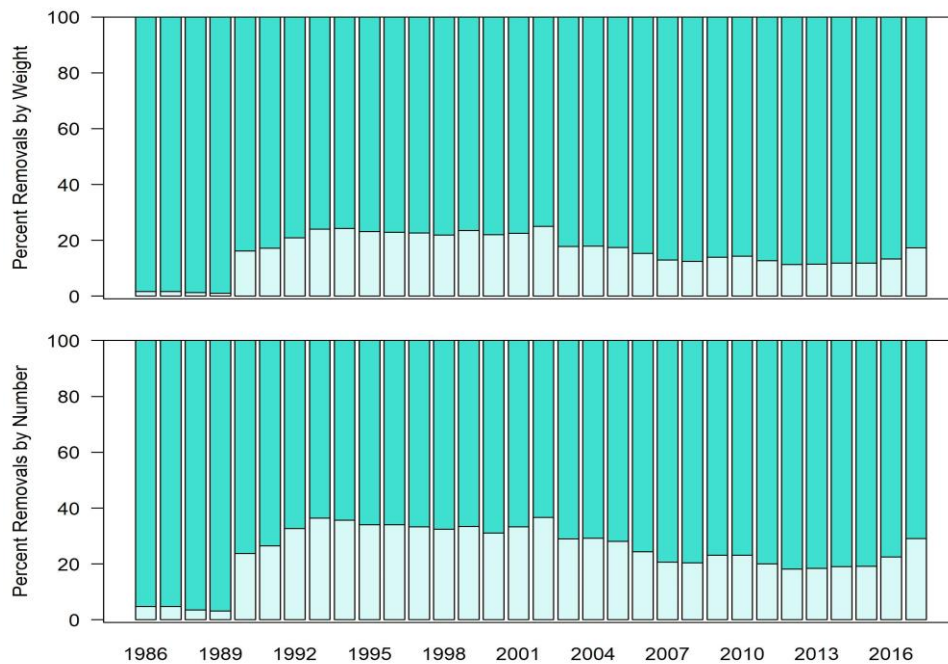

Figure RW27B. Comparison of landings (light bars) and dead discards (dark bars) for weights (top panel) and numbers of fish (bottom panel) for the Recreational Charter Private fleet for Gulf of Mexico Scamp. Estimates of dead discards in both numbers and weights are provided in Table 22.

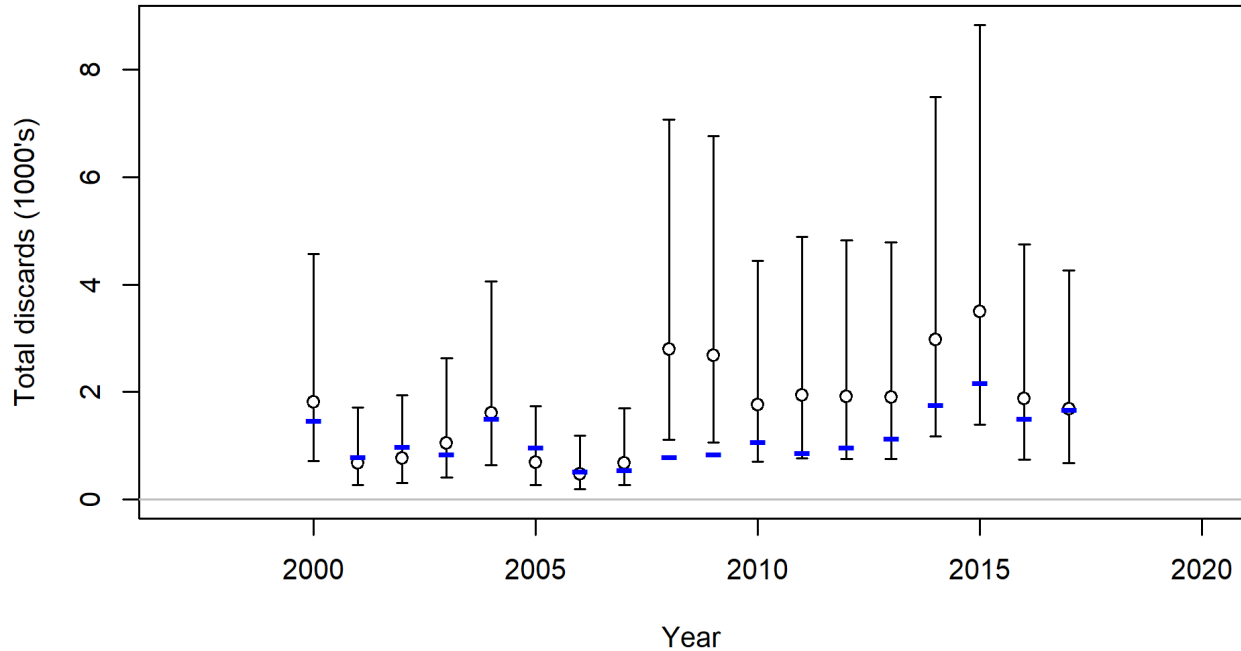

Figure RW27C. Input (dots with 95% confidence intervals) and expected (blue lines) discards by the Recreational Headboat fleet for Gulf of Mexico Scamp. Discards are in numbers of fish (1,000s) and reflect released fish (i.e., before discard mortality has been applied).

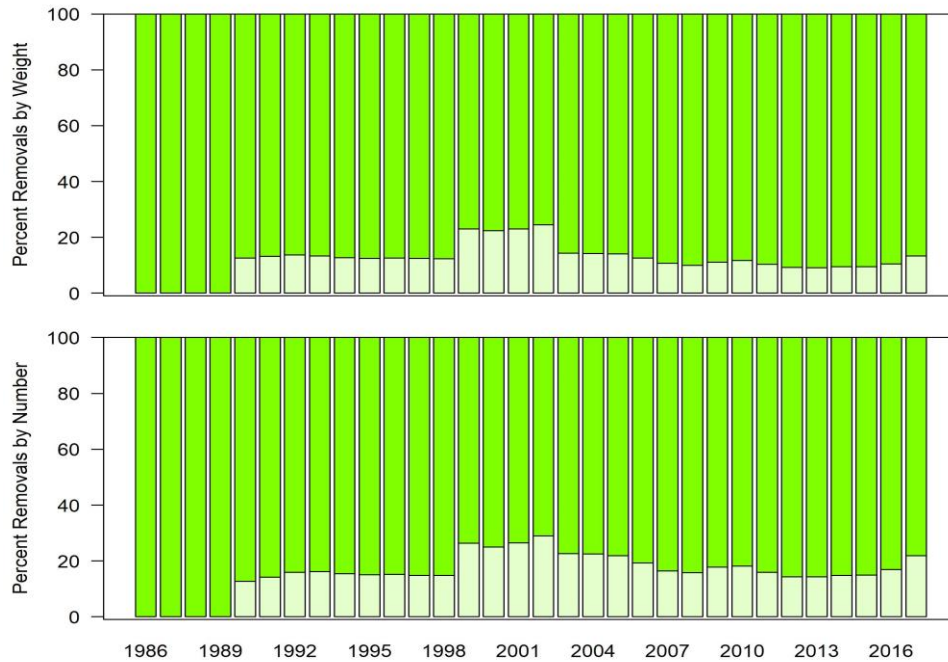

Figure RW27D. Comparison of landings (light bars) and dead discards (dark bars) for weights (top panel) and numbers of fish (bottom panel) for the Recreational Headboat fleet for Gulf of Mexico Scamp. Estimates of dead discards in both numbers and weights are provided in Table 23.

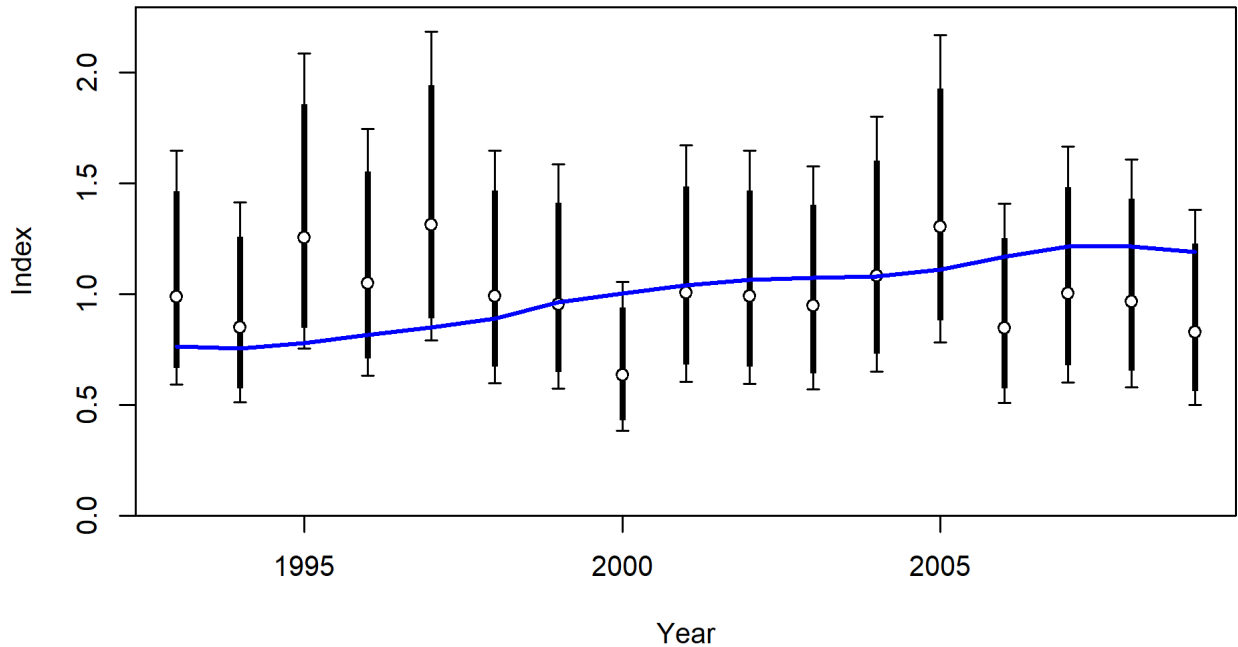

Figure RW28A. Input (dots with 95% confidence intervals) and expected (blue lines) indices of relative abundance for Gulf of Mexico Scamp retained by the Commercial Vertical Line fleet prior to the implementation of the Grouper-Tilefish Individual Fishing Quota. An extra variance of 0.06 was added to the input SE for each year.

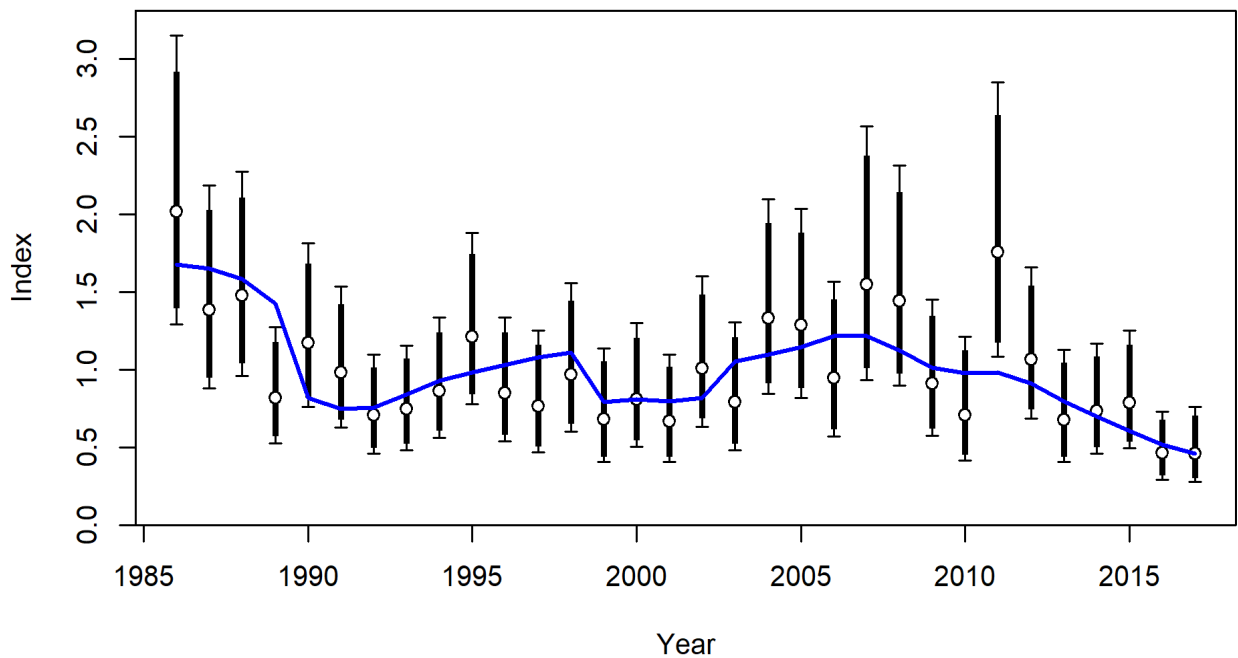

Figure RW28B. Input (dots with 95% confidence intervals) and expected (blue lines) indices of relative abundance for Gulf of Mexico Scamp retained by the Recreational Headboat fleet. An extra variance of 0.039 was added to the input SE for each year.

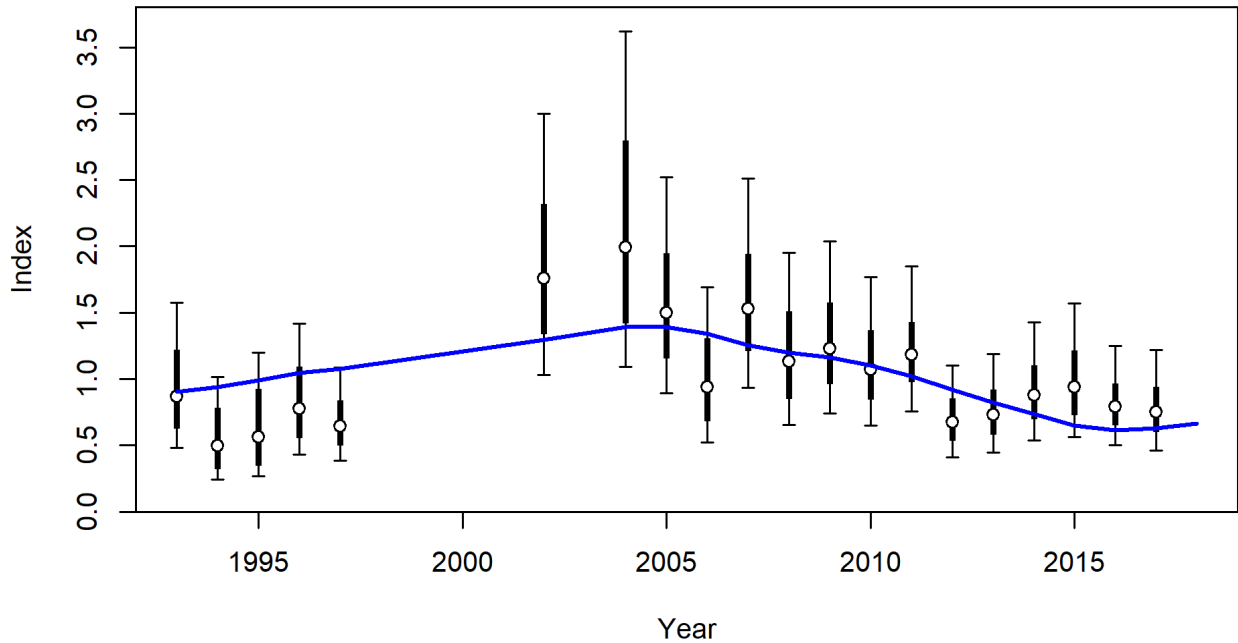

Figure RW28C. Input (dots with 95% confidence intervals) and expected (blue lines) indices of relative abundance for Gulf of Mexico Scamp from the Combined Video Survey. An extra variance of 0.132 was added to the input SE for each year.

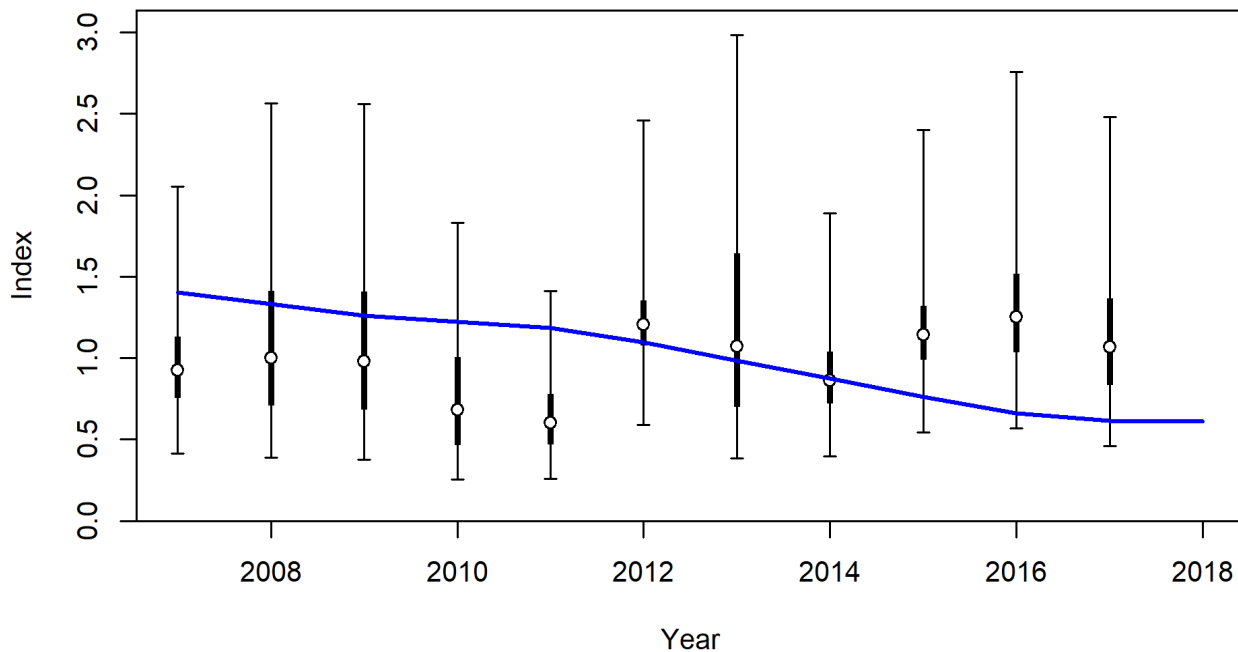

Figure RW28D. Input (dots with 95% confidence intervals) and expected (blue lines) indices of relative abundance for Gulf of Mexico Scamp from the RFOP Vertical Line Survey. An extra variance of 0.305 was added to the input SE for each year.

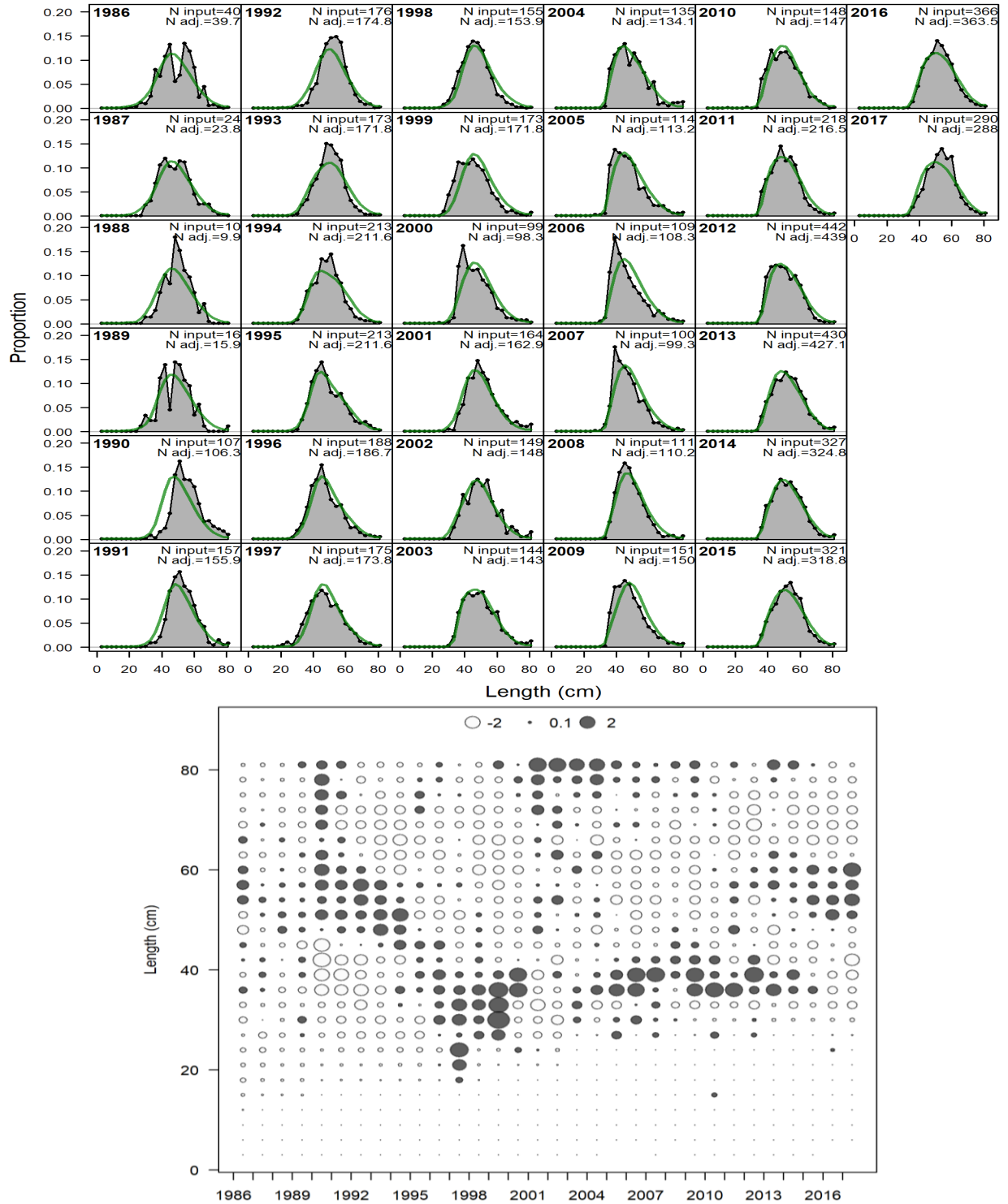

Figure RW29A. Observed and expected length compositions and Pearson residuals for Gulf of Mexico Scamp landed by the Commercial Vertical Line fleet. Green lines represent expected length compositions, while grey shaded regions represent observed length compositions. Input sample sizes (N input) and adjusted sample sizes (N adj) estimated by SS are also reported. Closed bubbles are positive residuals ($Obs > Exp$) and open bubbles are negative residuals ($Obs < Exp$).

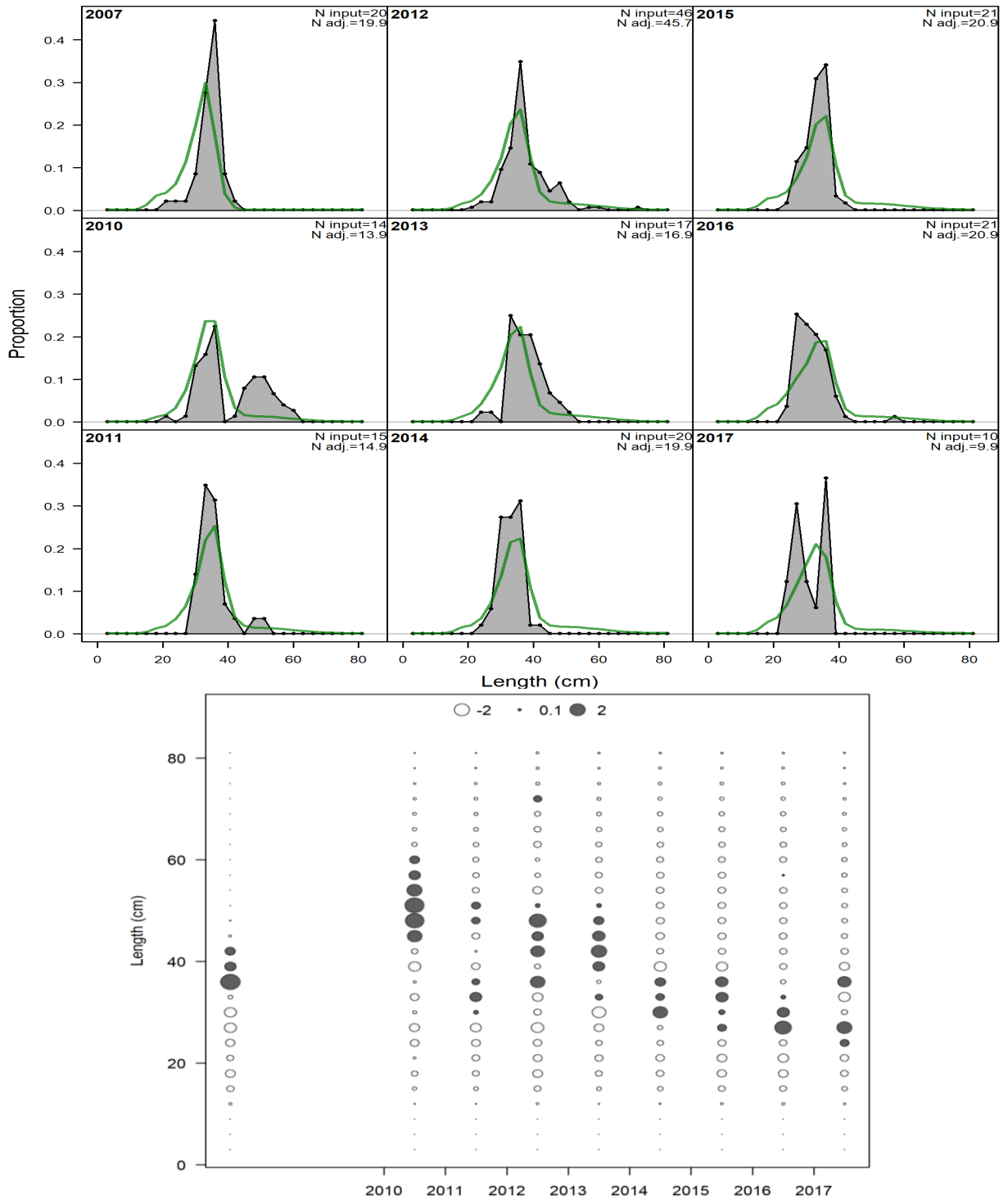

Figure RW29B. Observed and expected length compositions and Pearson residuals for Gulf of Mexico Scamp discarded by the Commercial Vertical Line fleet. Green lines represent expected length compositions, while grey shaded regions represent observed length compositions. Input sample sizes (N input) and adjusted sample sizes (N adj) estimated by SS are also reported. Closed bubbles are positive residuals ($Obs > Exp$) and open bubbles are negative residuals ($Obs < Exp$).

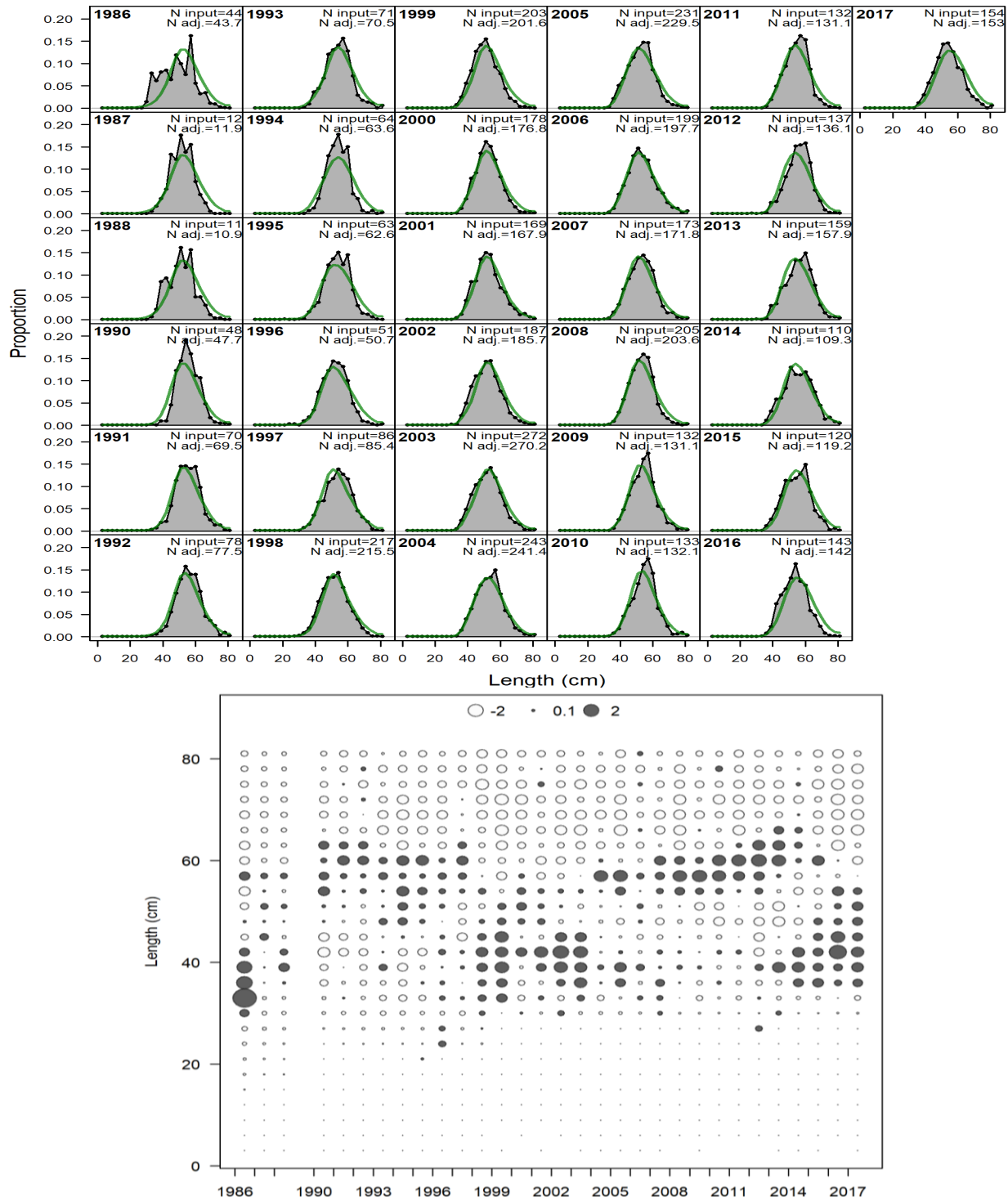

Figure RW29C. Observed and expected length compositions and Pearson residuals for Gulf of Mexico Scamp landed by the Commercial Longline fleet. Green lines represent expected length compositions, while grey shaded regions represent observed length compositions. Input sample sizes (N_{input}) and adjusted sample sizes (N_{adj}) estimated by SS are also reported. Closed bubbles are positive residuals ($Obs > Exp$) and open bubbles are negative residuals ($Obs < Exp$).

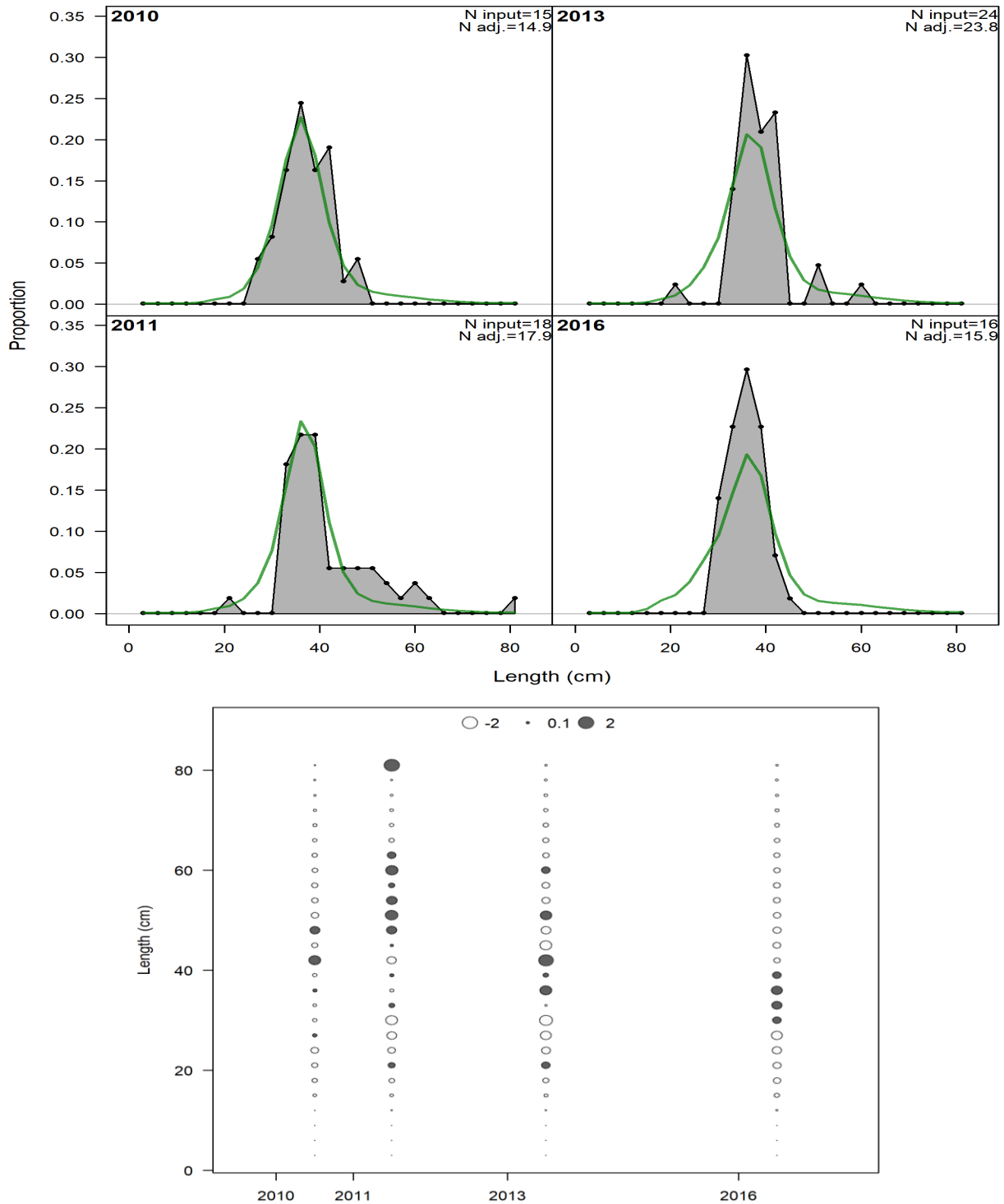

Figure RW29D. Observed and expected length compositions and Pearson residuals for Gulf of Mexico Scamp discarded by the Commercial Longline fleet. Green lines represent expected length compositions, while grey shaded regions represent observed length compositions. Input sample sizes (N_{input}) and adjusted sample sizes (N_{adj}) estimated by SS are also reported. Closed bubbles are positive residuals ($Obs > Exp$) and open bubbles are negative residuals ($Obs < Exp$).

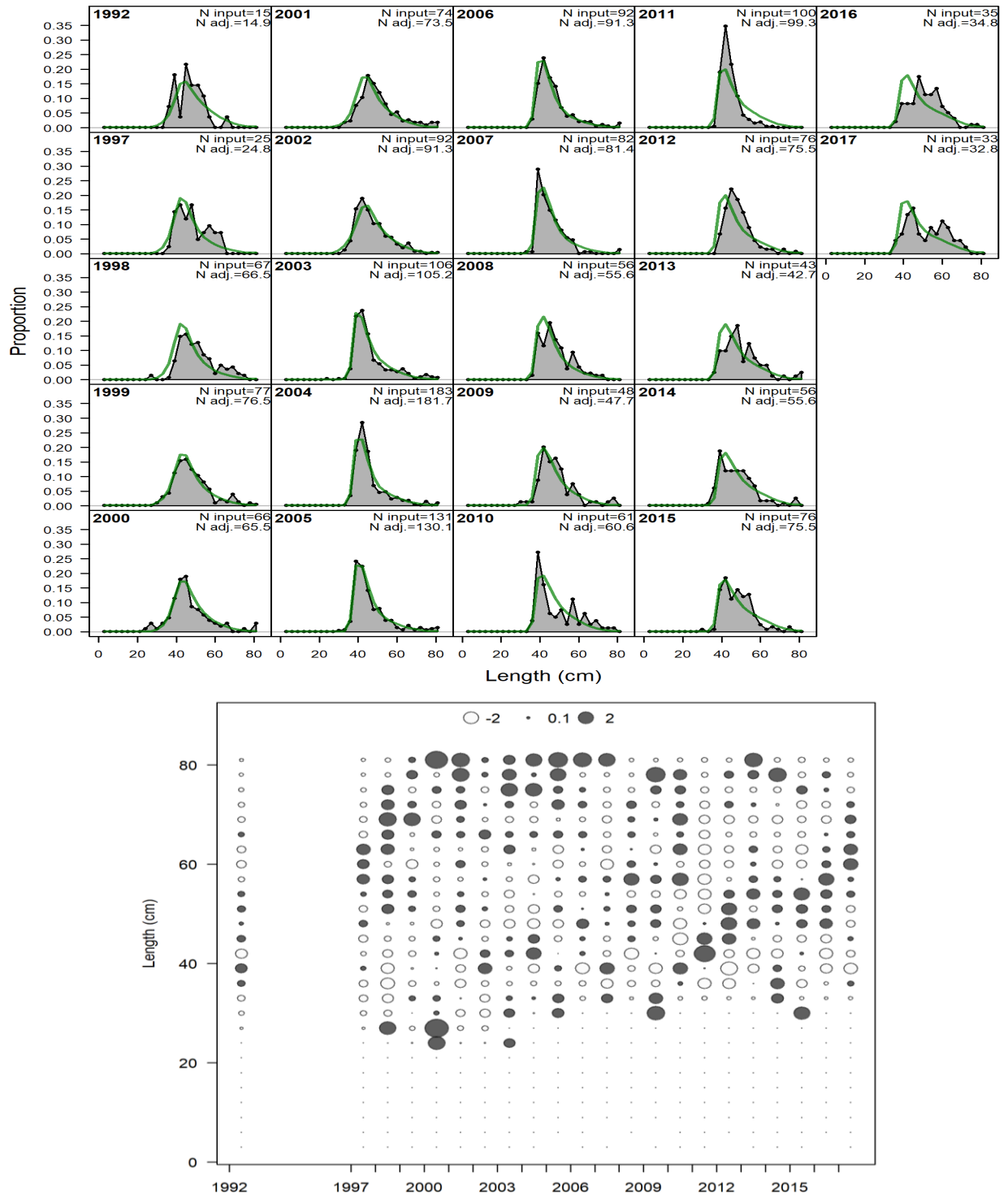

Figure RW30A. Observed and expected length compositions and Pearson residuals for Gulf of Mexico Scamp landed by the Recreational Charter Private fleet. Green lines represent expected length compositions, while grey shaded regions represent observed length compositions. Input sample sizes (N input) and adjusted sample sizes (N adj.) estimated by SS are also reported. Closed bubbles are positive residuals ($Obs > Exp$) and open bubbles are negative residuals ($Obs < Exp$).

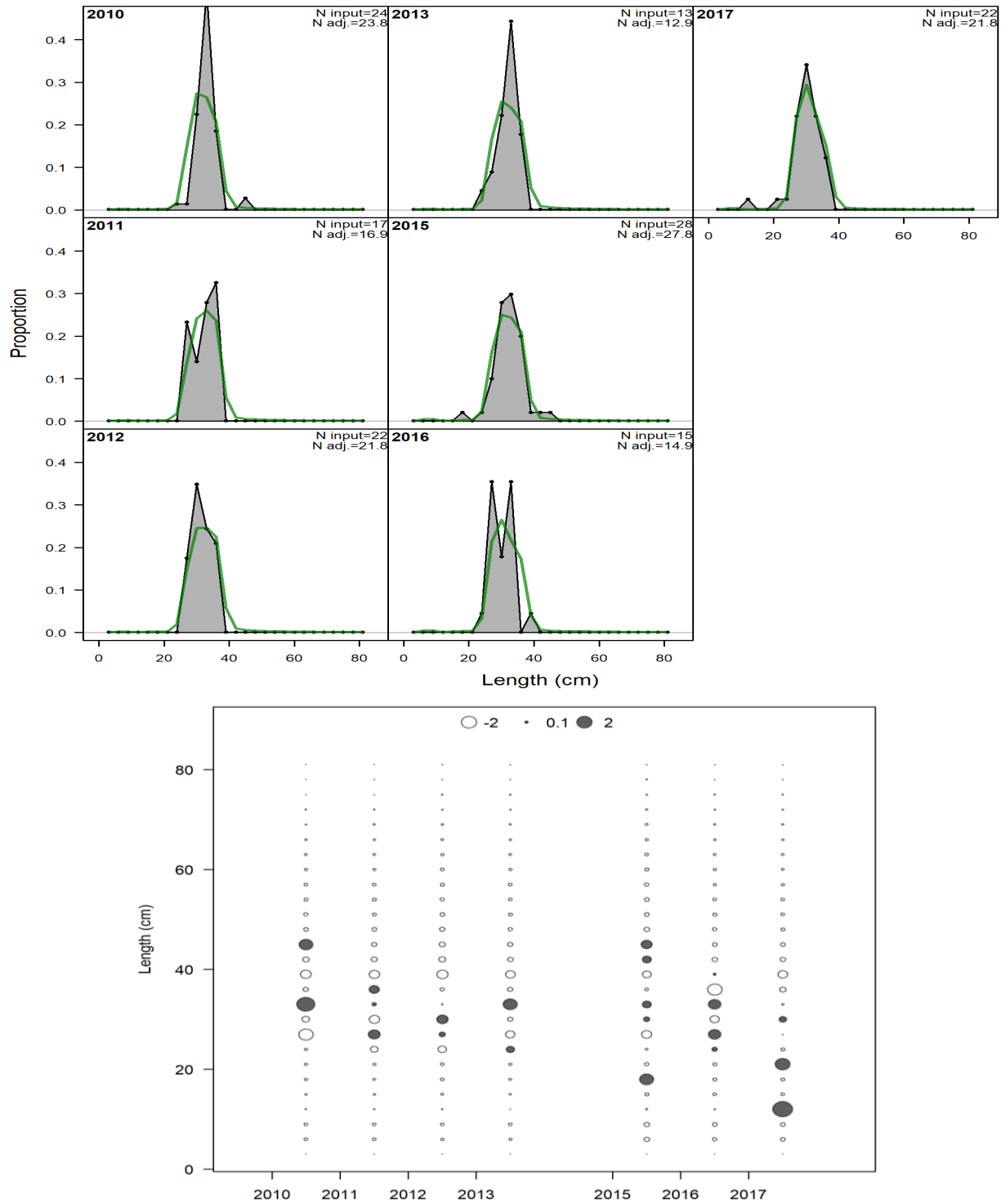

Figure RW30B. Observed and expected length compositions and Pearson residuals for Gulf of Mexico Scamp discarded by the Recreational Charter Private fleet. Green lines represent expected length compositions, while grey shaded regions represent observed length compositions. Input sample sizes (N input) and adjusted sample sizes (N adj) estimated by SS are also reported. Closed bubbles are positive residuals ($Obs > Exp$) and open bubbles are negative residuals ($Obs < Exp$).

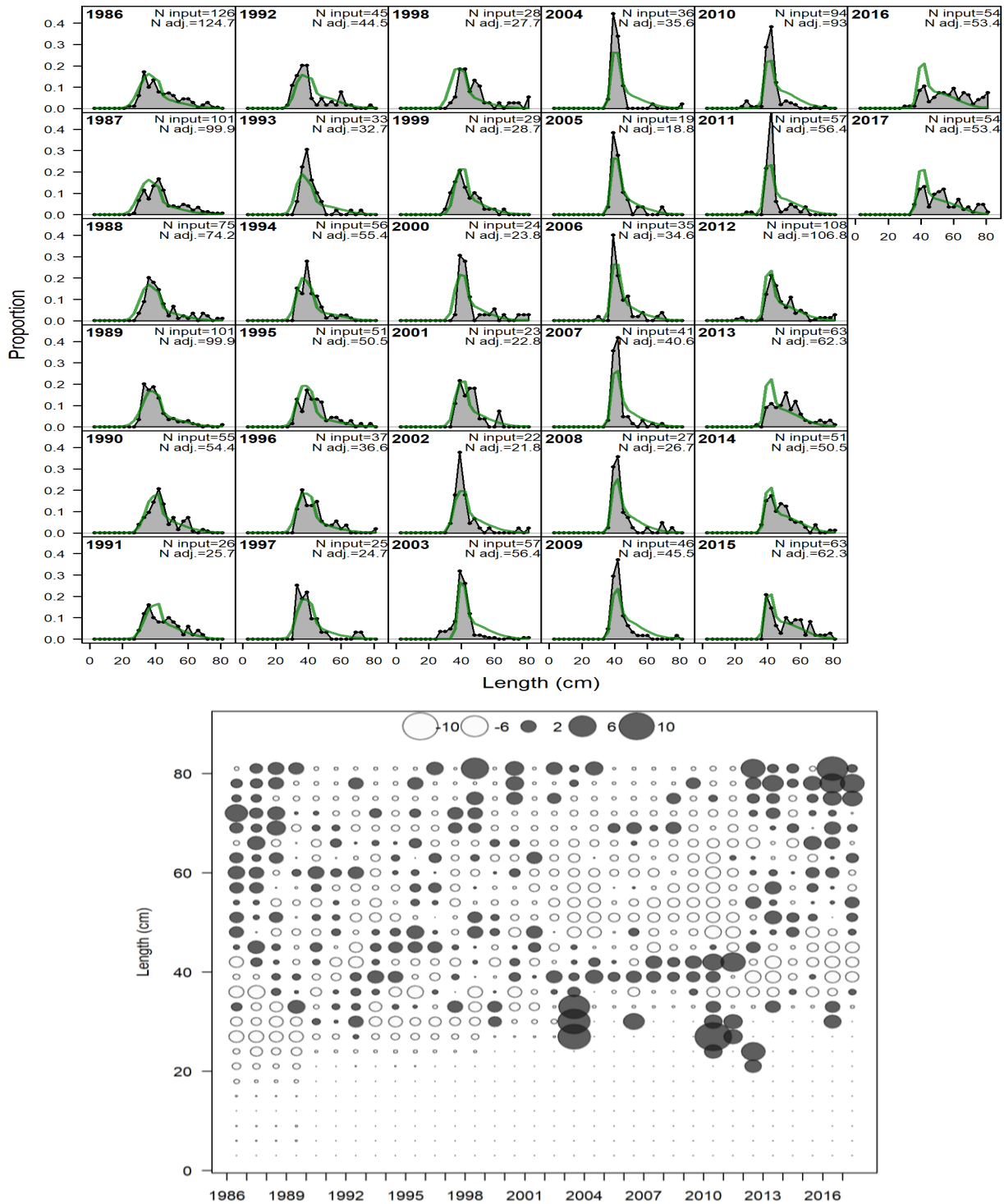

Figure RW30C. Observed and expected length compositions and Pearson residuals for Gulf of Mexico Scamp landed by the Recreational Headboat fleet. Green lines represent expected length compositions, while grey shaded regions represent observed length compositions. Input sample sizes (N input) and adjusted sample sizes (N adj) estimated by SS are also reported. Closed bubbles are positive residuals ($Obs > Exp$) and open bubbles are negative residuals ($Obs < Exp$).

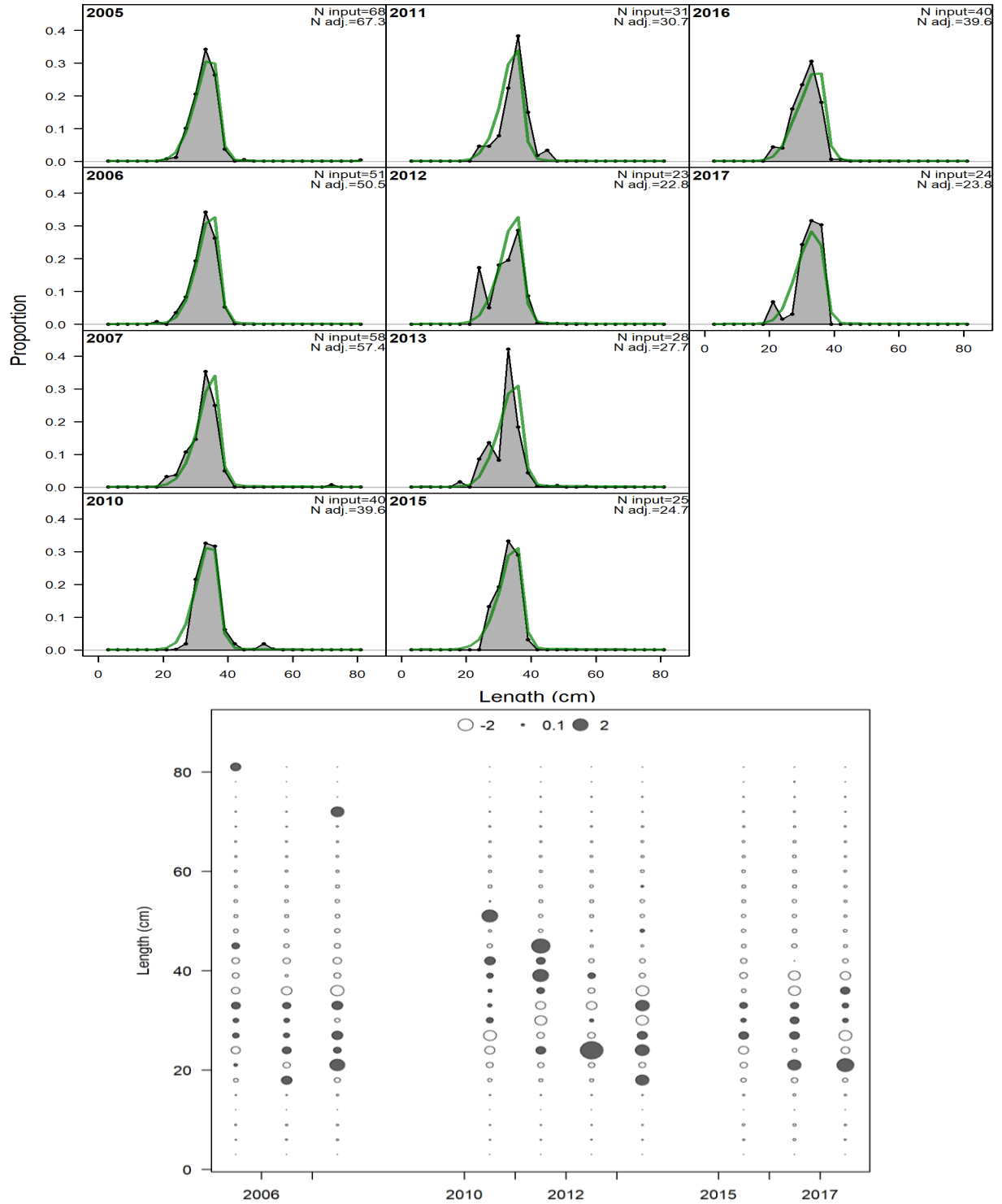

Figure RW30D. Observed and expected length compositions and Pearson residuals for Gulf of Mexico Scamp discarded by the Recreational Headboat fleet. Green lines represent expected length compositions, while grey shaded regions represent observed length compositions. Input sample sizes (N input) and adjusted sample sizes (N adj) estimated by SS are also reported. Closed bubbles are positive residuals ($Obs > Exp$) and open bubbles are negative residuals ($Obs < Exp$).

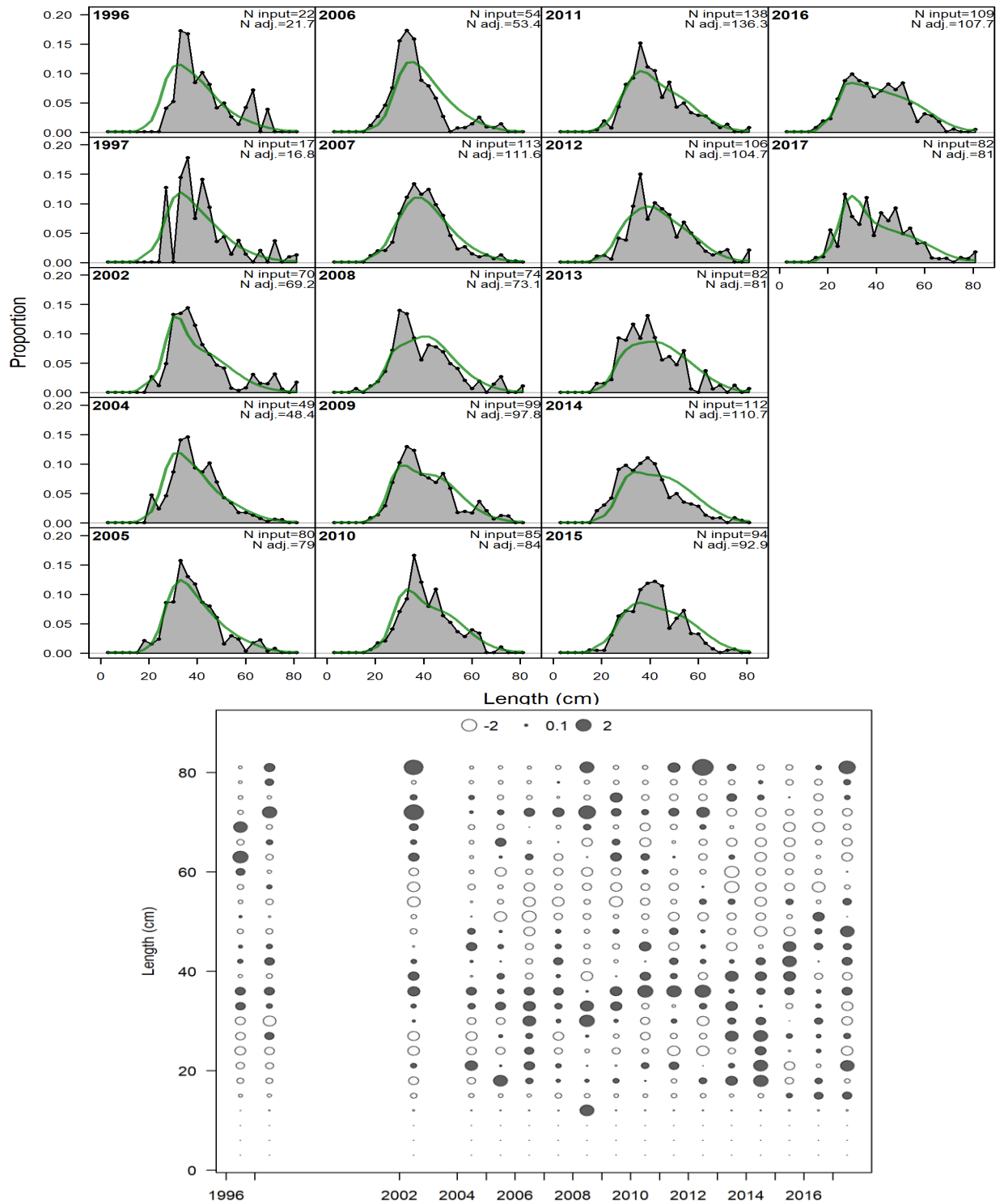

Figure RW31. Observed and expected length compositions and Pearson residuals for Gulf of Mexico Scamp in the Combined Video Survey. Green lines represent expected length compositions, while grey shaded regions represent observed length compositions. Input sample sizes (N_{input}) and adjusted sample sizes (N_{adj}) estimated by SS are also reported. Closed bubbles are positive residuals ($Obs > Exp$) and open bubbles are negative residuals ($Obs < Exp$).

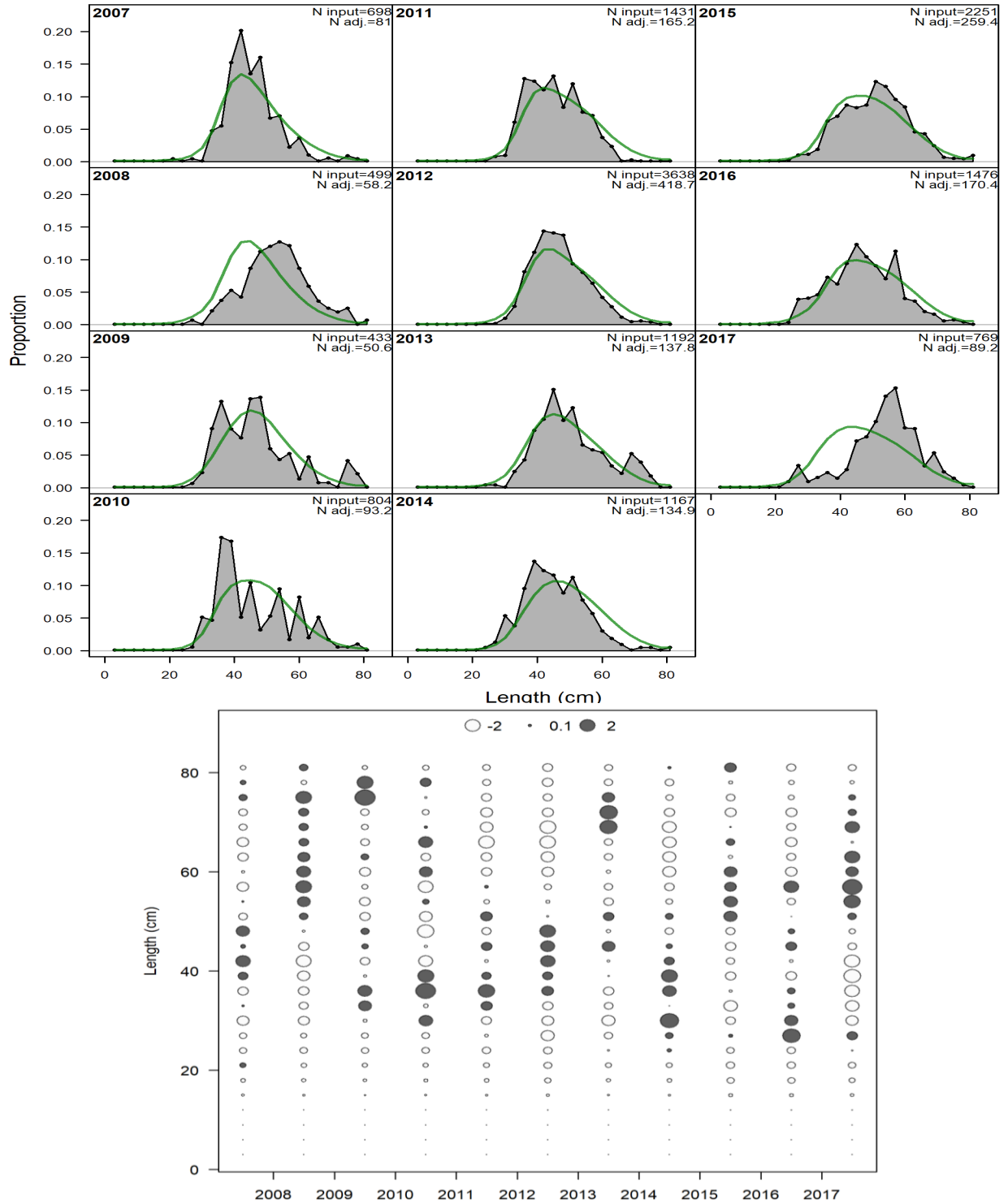

Figure RW32. Observed and expected length compositions and Pearson residuals for Gulf of Mexico Scamp in the RFOP Vertical Line Survey. Green lines represent expected length compositions, while grey shaded regions represent observed length compositions. Input sample sizes (N_{input}) and adjusted sample sizes (N_{adj}) estimated by SS are also reported. Closed bubbles are positive residuals ($Obs > Exp$) and open bubbles are negative residuals ($Obs < Exp$).

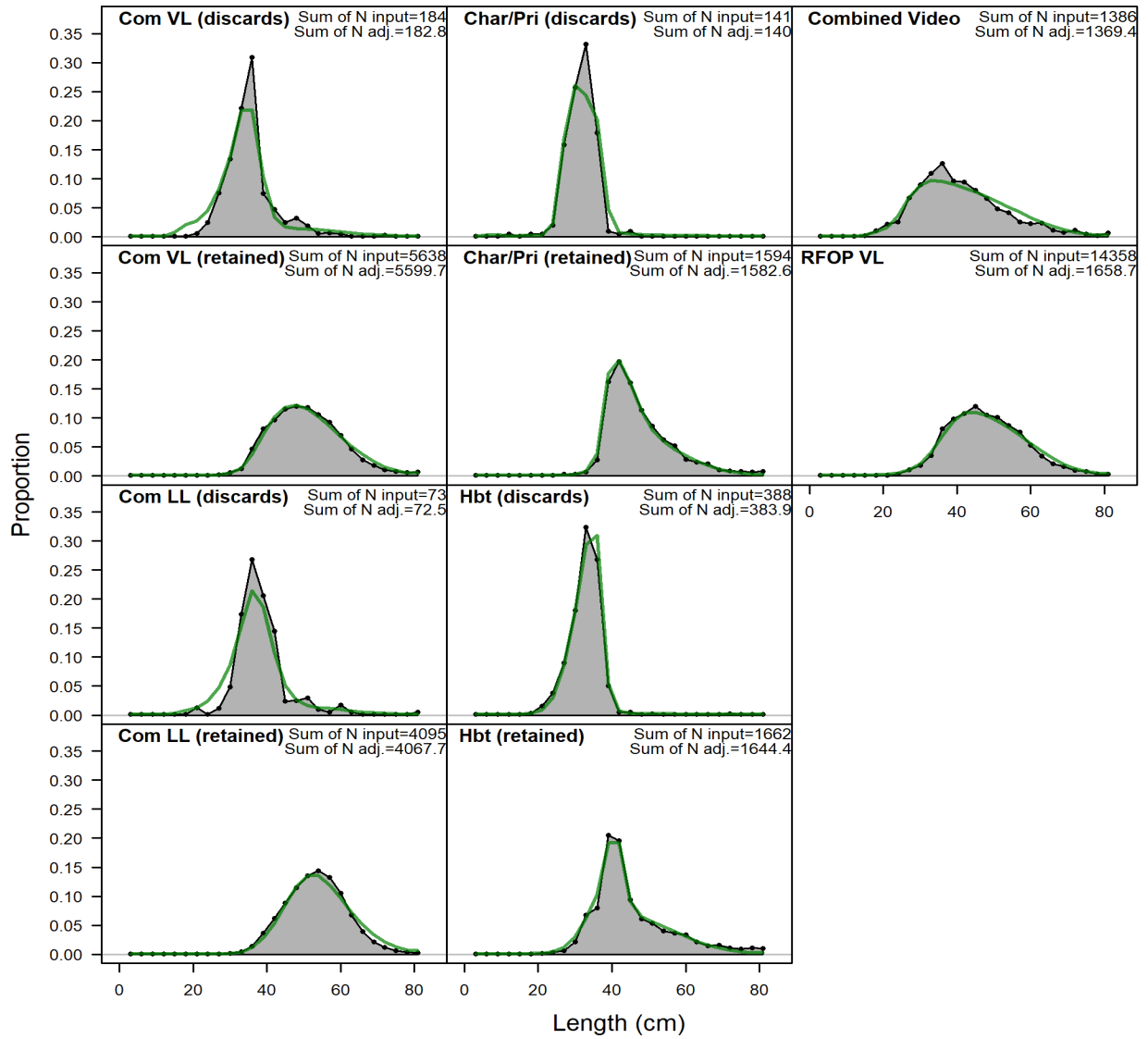

Figure RW33. Model fits to the length composition of discarded or landed (i.e., retained) catch aggregated across years within a given fleet or survey for Gulf of Mexico Scamp. Green lines represent expected length compositions, while grey shaded regions represent observed length compositions. The input (N_{input}) and adjusted (N_{adj}) sample sizes are provided in the upper right corner of each panel. Abbreviations include: Commercial Vertical Line (Com VL), Commercial Longline (Com LL), Recreational Charter Private (Char/Pri), Recreational Headboat (Hbt), and Reef Fish Observer Program Vertical Line (RFOP VL).

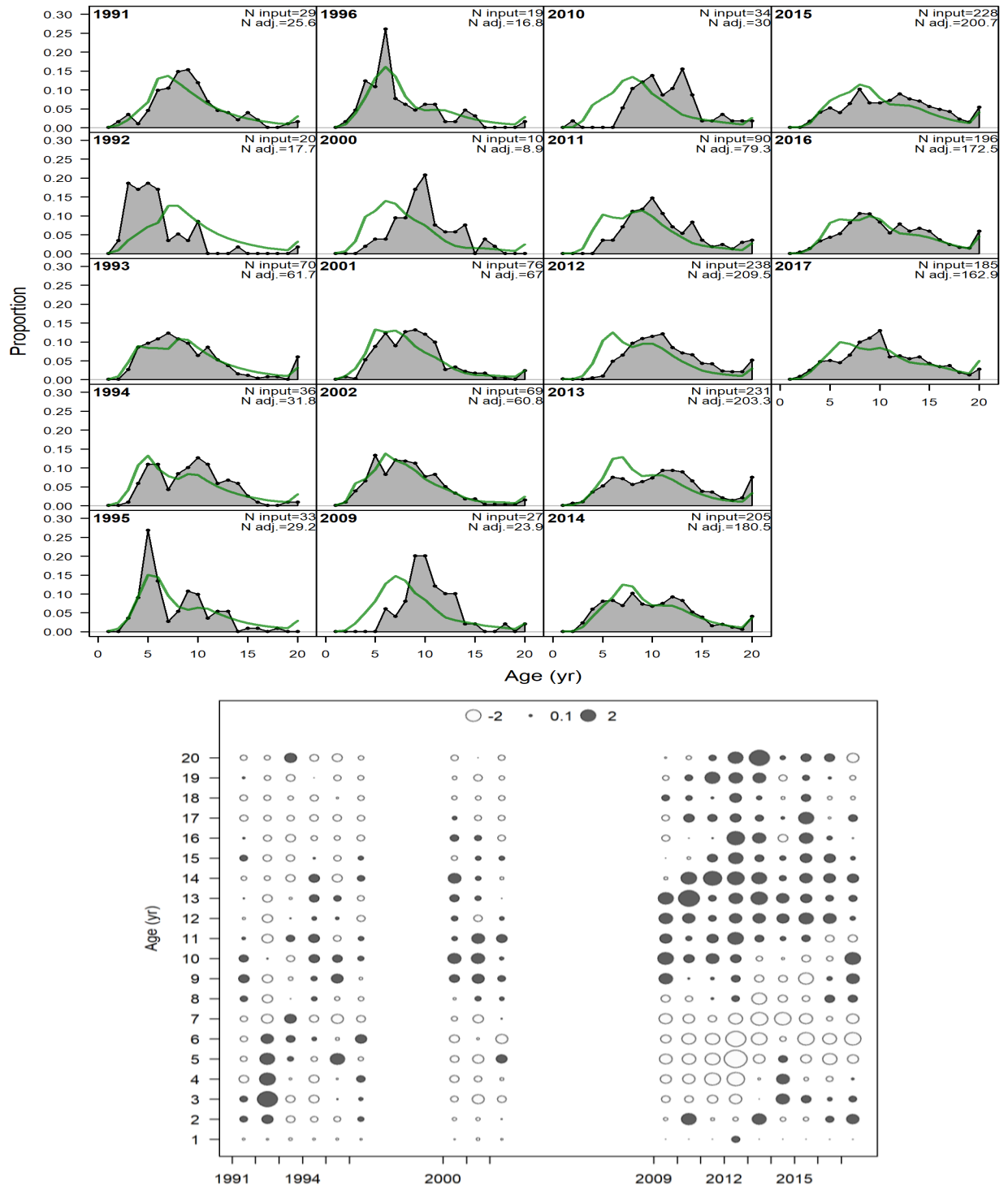

Figure RW34A. Observed and expected age compositions and Pearson residuals for Gulf of Mexico Scamp landed by the Commercial Vertical Line fleet. Green lines represent expected age compositions, while grey shaded regions represent observed age compositions. Input sample sizes (N_{input}) and adjusted sample sizes (N_{adj}) estimated by SS are also reported. Closed bubbles are positive residuals ($Obs > Exp$) and open bubbles are negative residuals ($Obs < Exp$).

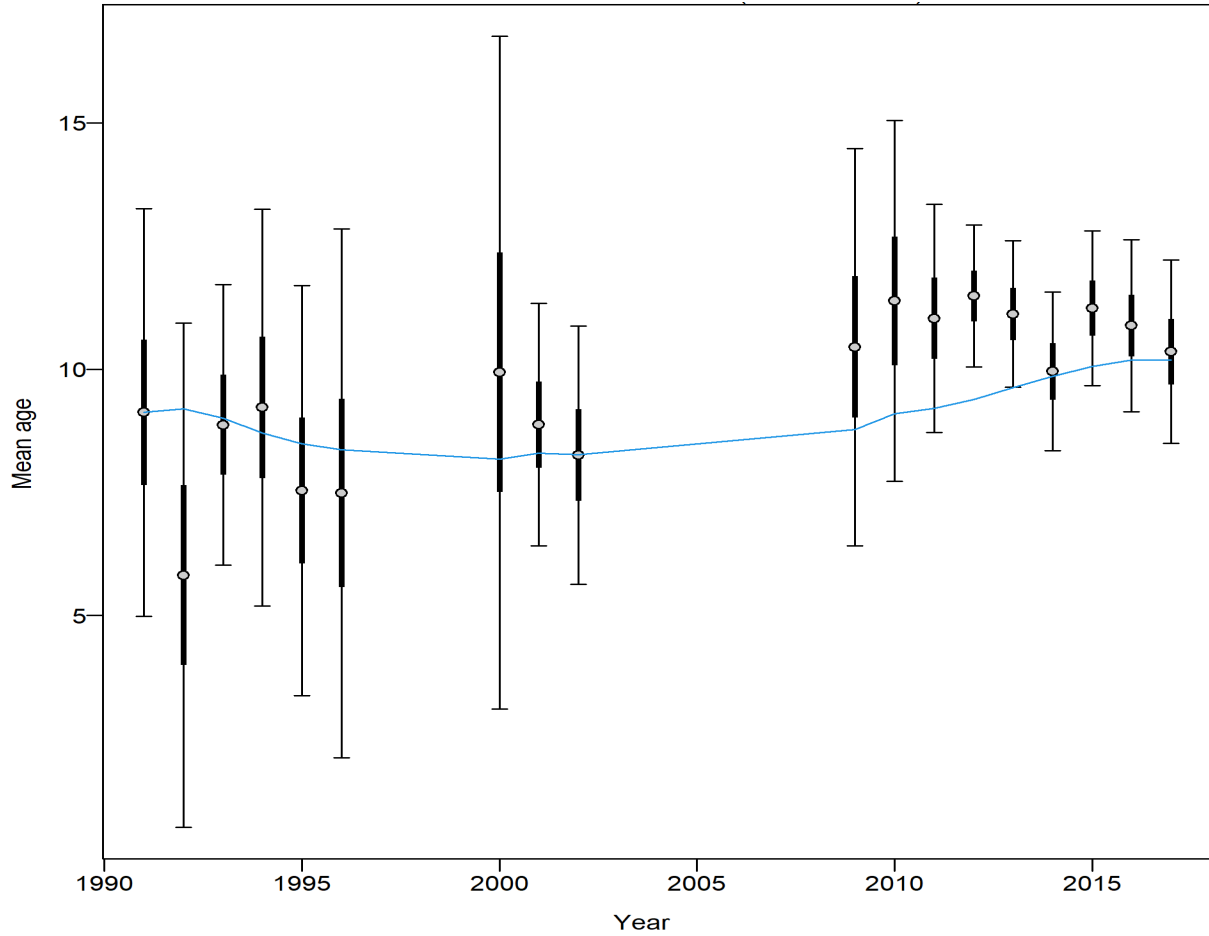

Figure RW34B. Mean age of landed Gulf of Mexico Scamp from data (aggregated across length bins) by the Commercial Vertical Line fleet with 95% confidence intervals (thick bars). Thinner intervals (with capped ends) show the result of further adjusting sample sizes based on the Francis data weighting method, which was not used here.

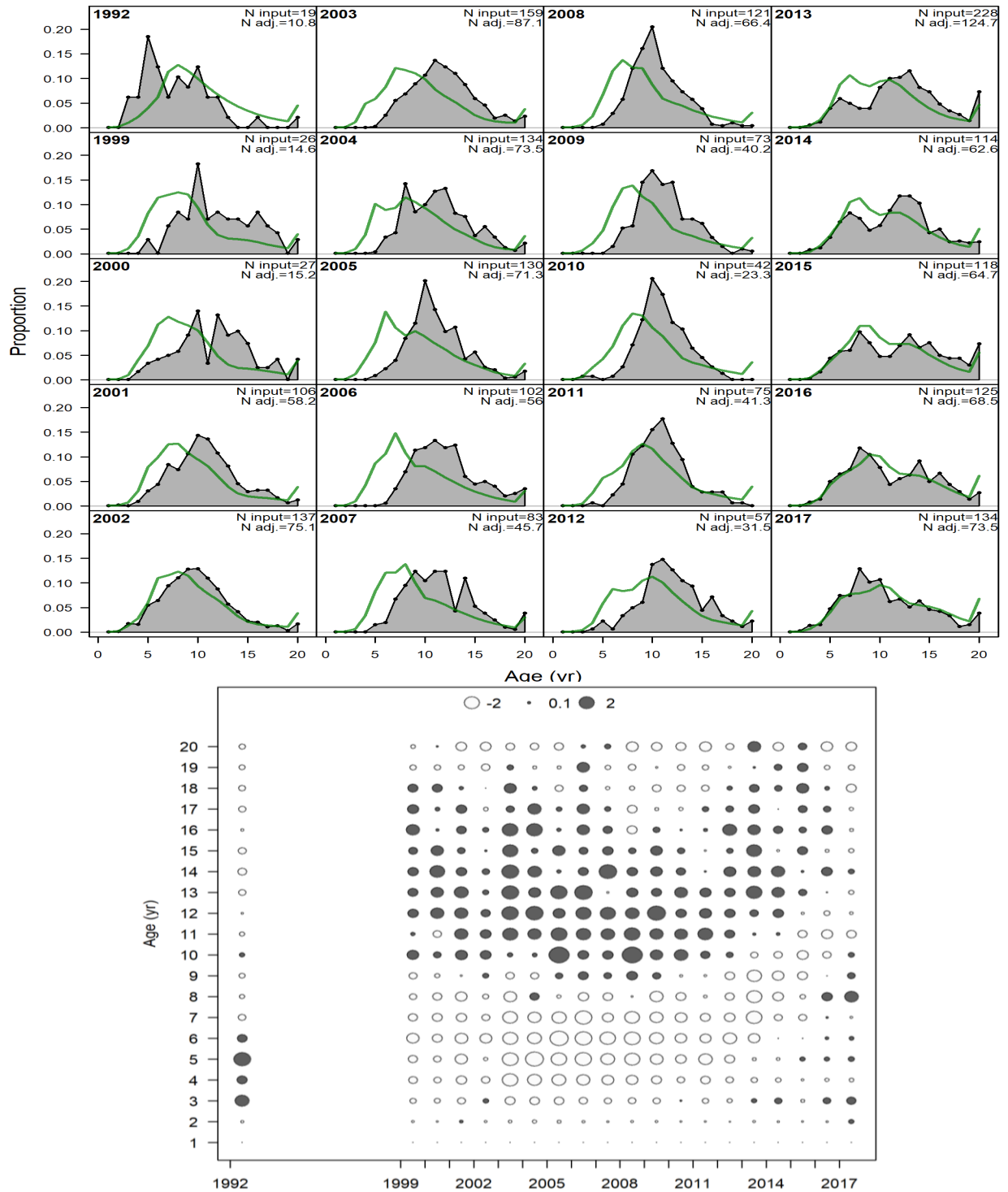

Figure RW35A. Observed and expected age compositions and Pearson residuals for Gulf of Mexico Scamp landed by the Commercial Longline fleet. Green lines represent expected age compositions, while grey shaded regions represent observed age compositions. Input sample sizes (N input) and adjusted sample sizes (N adj) estimated by SS are also reported. Closed bubbles are positive residuals (Obs > Exp) and open bubbles are negative residuals (Obs < Exp).

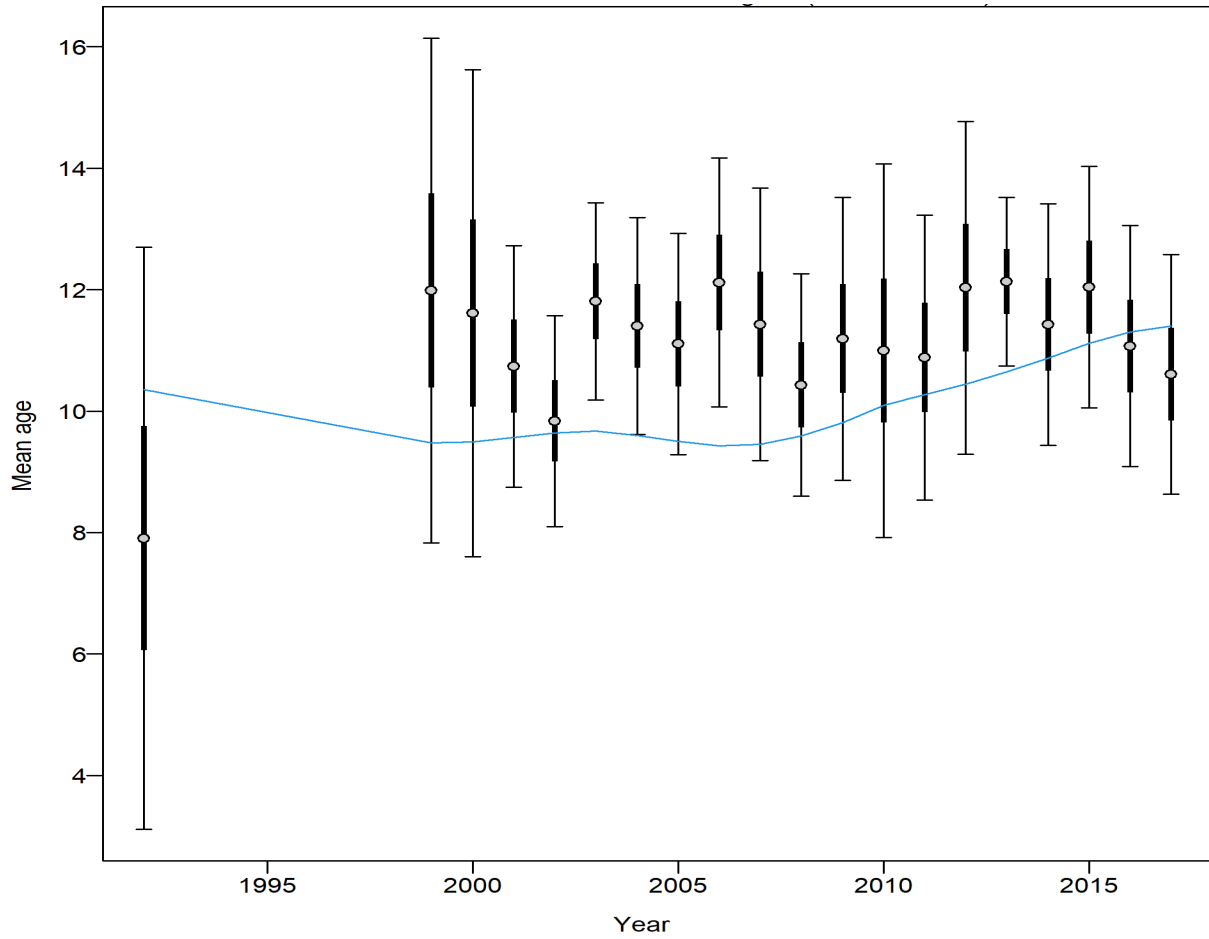

Figure RW35B. Mean age of landed Gulf of Mexico Scamp from data (aggregated across length bins) by the Commercial Longline fleet with 95% confidence intervals (thick bars). Thinner intervals (with capped ends) show the result of further adjusting sample sizes based on the Francis data weighting method, which was not used here.

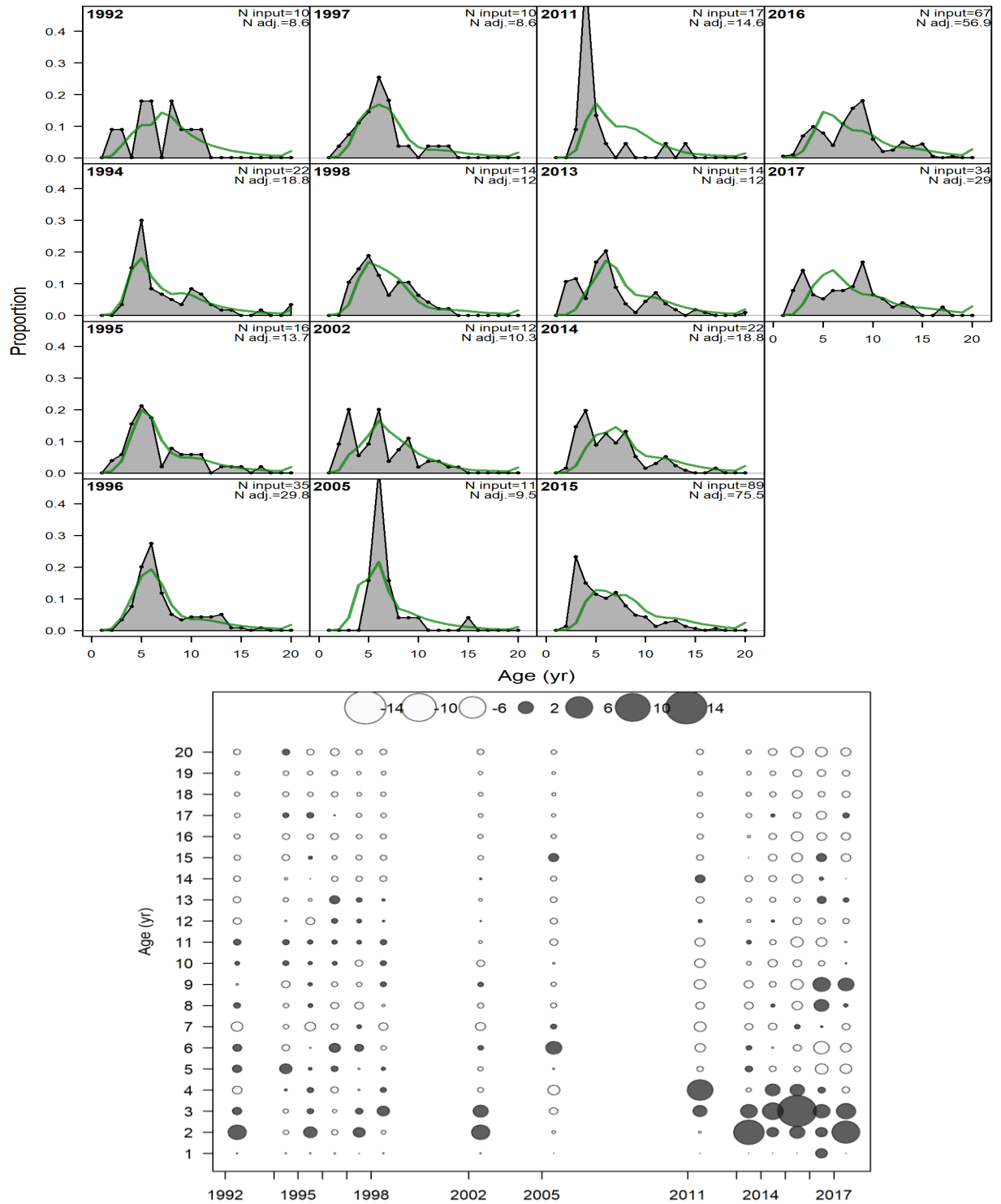

Figure RW36A. Observed and expected age compositions and Pearson residuals for Gulf of Mexico Scamp landed by the Recreational Charter Private fleet. Green lines represent expected length compositions, while grey shaded regions represent observed length compositions. Input sample sizes (N input) and adjusted sample sizes (N adj.) estimated by SS are also reported. Closed bubbles are positive residuals ($Obs > Exp$) and open bubbles are negative residuals ($Obs < Exp$).

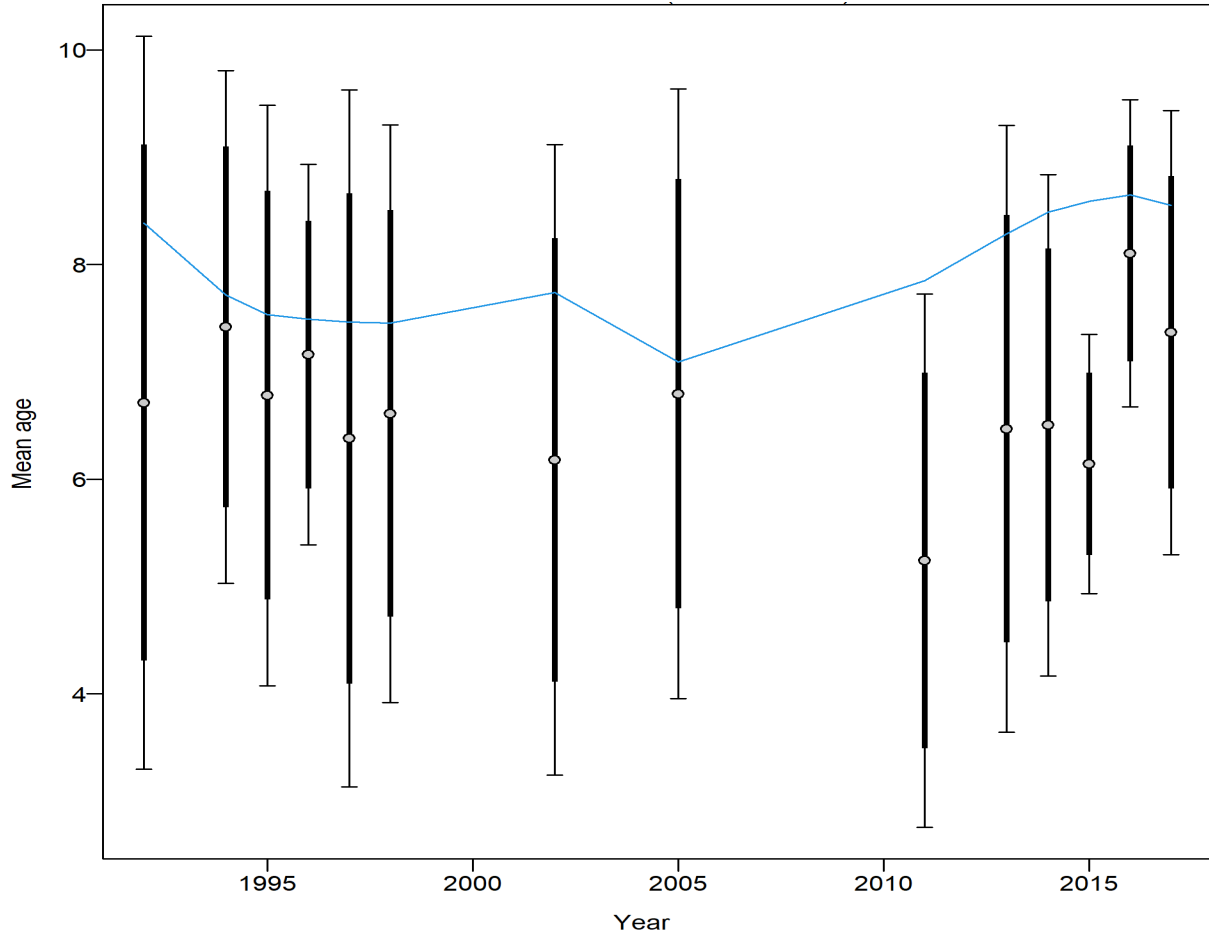

Figure RW36B. Mean age of landed Gulf of Mexico Scamp from data (aggregated across length bins) by the Recreational Charter Private fleet with 95% confidence intervals (thick bars). Thinner intervals (with capped ends) show the result of further adjusting sample sizes based on the Francis data weighting method, which was not used here.

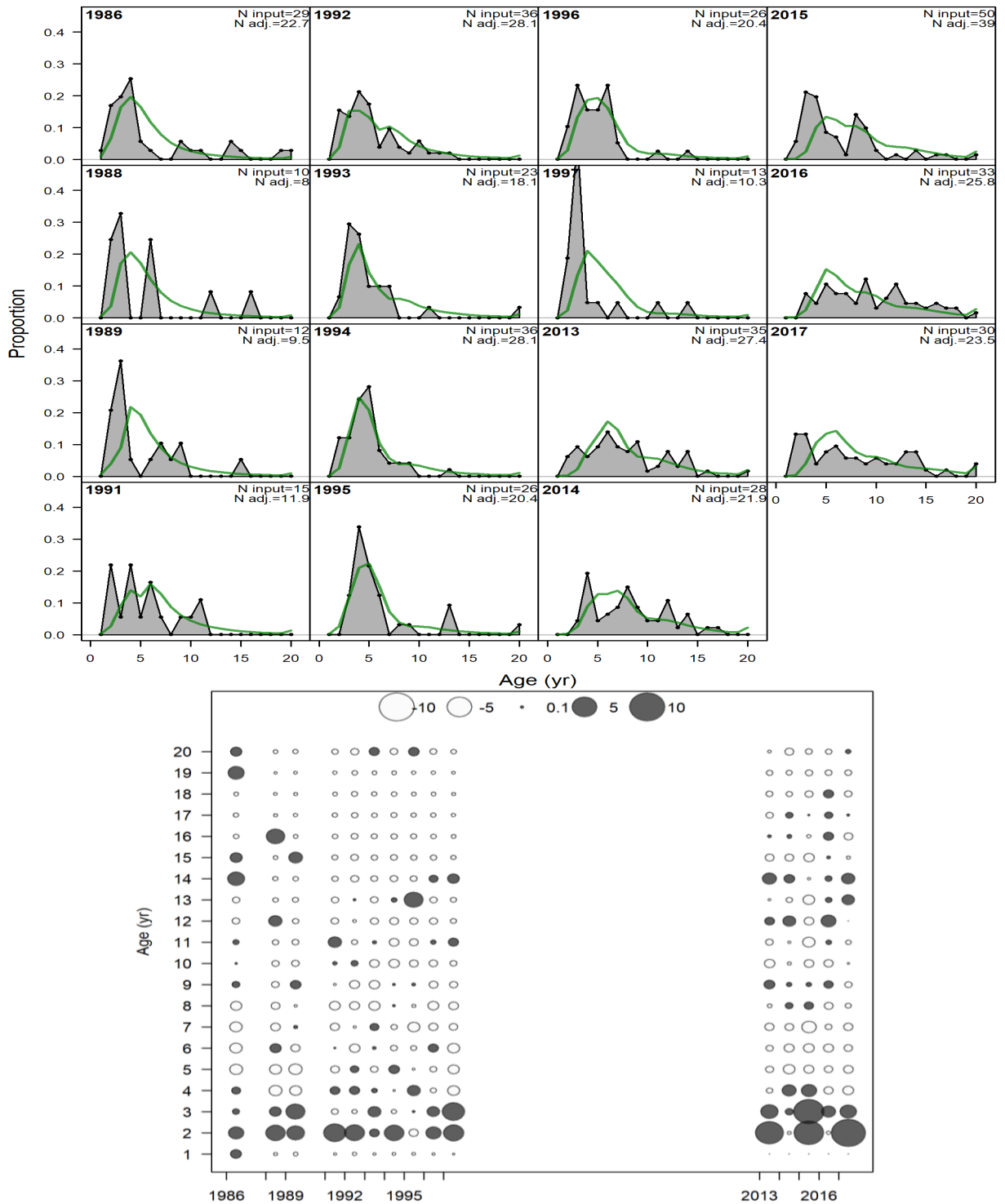

Figure RW37A. Observed and expected age compositions and Pearson residuals for Gulf of Mexico Scamp landed by the Recreational Headboat fleet. Green lines represent expected length compositions, while grey shaded regions represent observed length compositions. Input sample sizes (N input) and adjusted sample sizes (N adj) estimated by SS are also reported. Closed bubbles are positive residuals ($Obs > Exp$) and open bubbles are negative residuals ($Obs < Exp$).

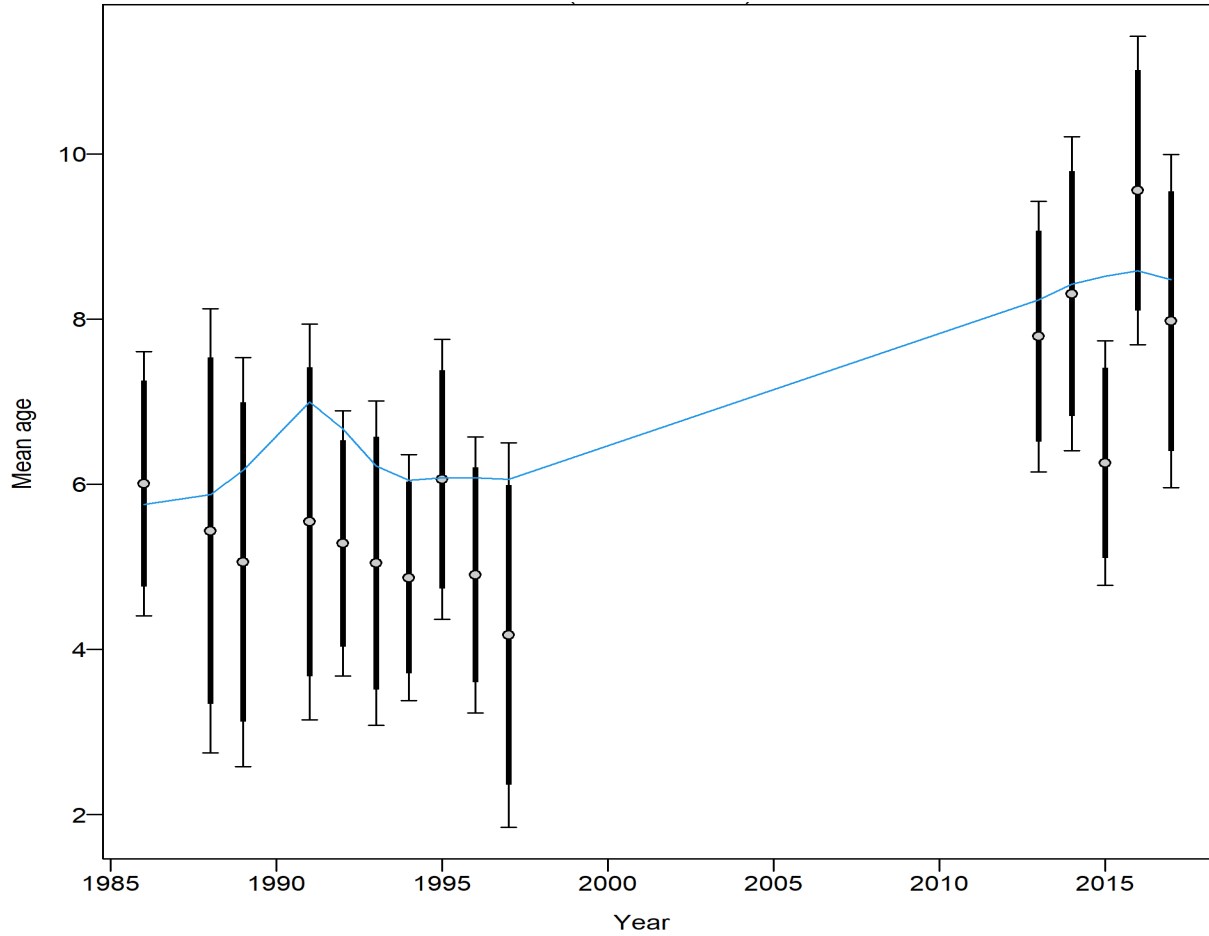

Figure RW37B. Mean age of landed Gulf of Mexico Scamp from data (aggregated across length bins) by the Recreational Headboat fleet with 95% confidence intervals (thick bars). Thinner intervals (with capped ends) show the result of further adjusting sample sizes based on the Francis data weighting method, which was not used here.

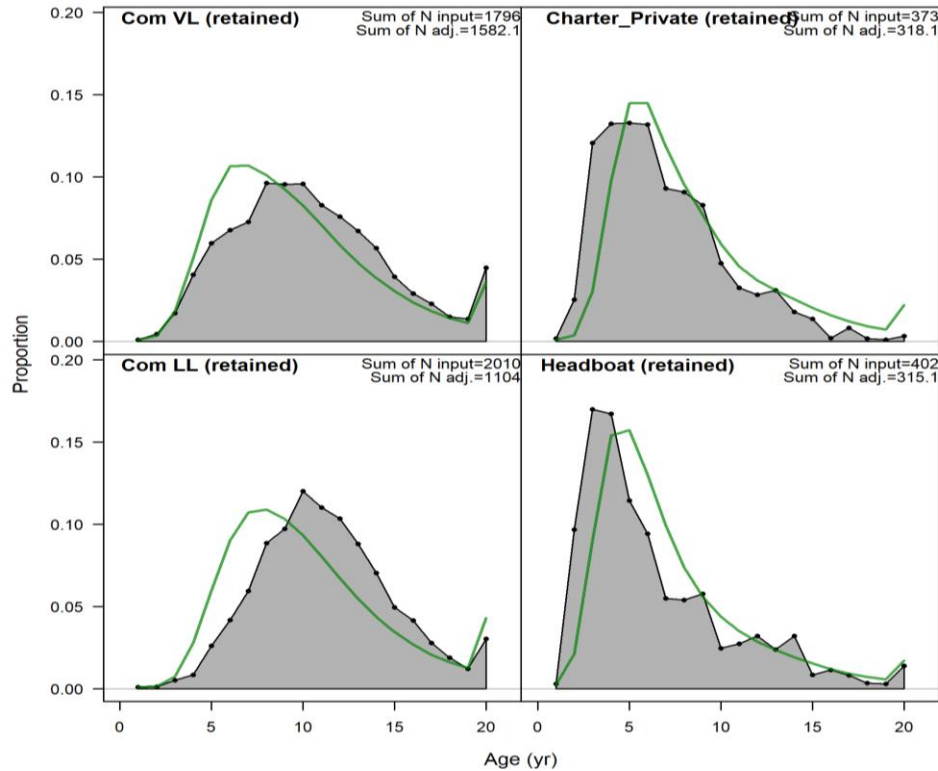

Figure RW38. Model fits to the age composition of landed Scamp aggregated across years within a given fleet for the Gulf of Mexico. Green lines represent expected age compositions, while grey shaded regions represent observed age compositions. The input (N input) and adjusted (N adj) sample sizes are provided in the upper right corner of each panel.

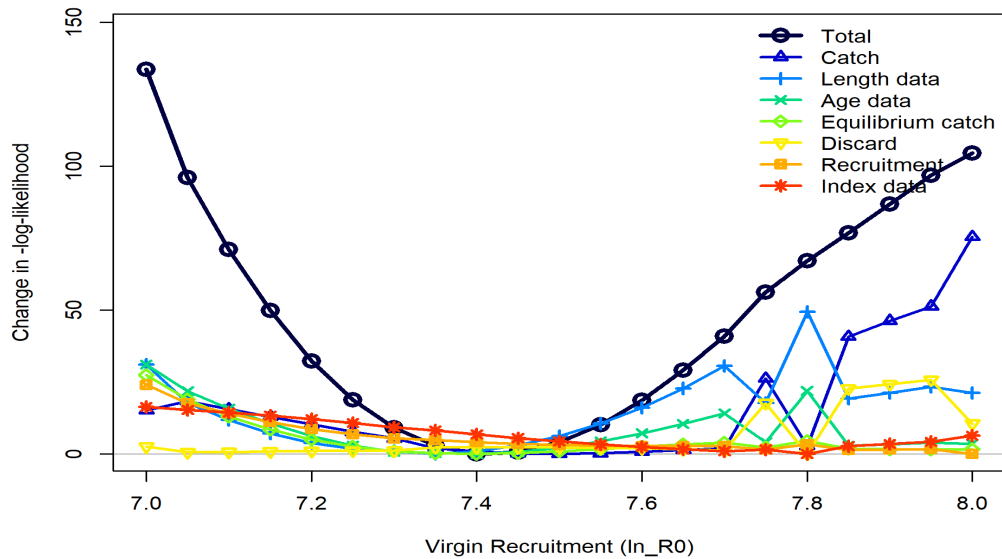

Figure RW39A. The profile likelihood for the natural log of the virgin recruitment parameter of the Beverton – Holt stock-recruit function for Gulf of Mexico Scamp. Each line represents the change in negative log-likelihood value for each of the data sources fit in the model across the range of fixed values tested. The MLE (CV) for the SEDAR 68 RW Base Model was 7.417 (0.004).

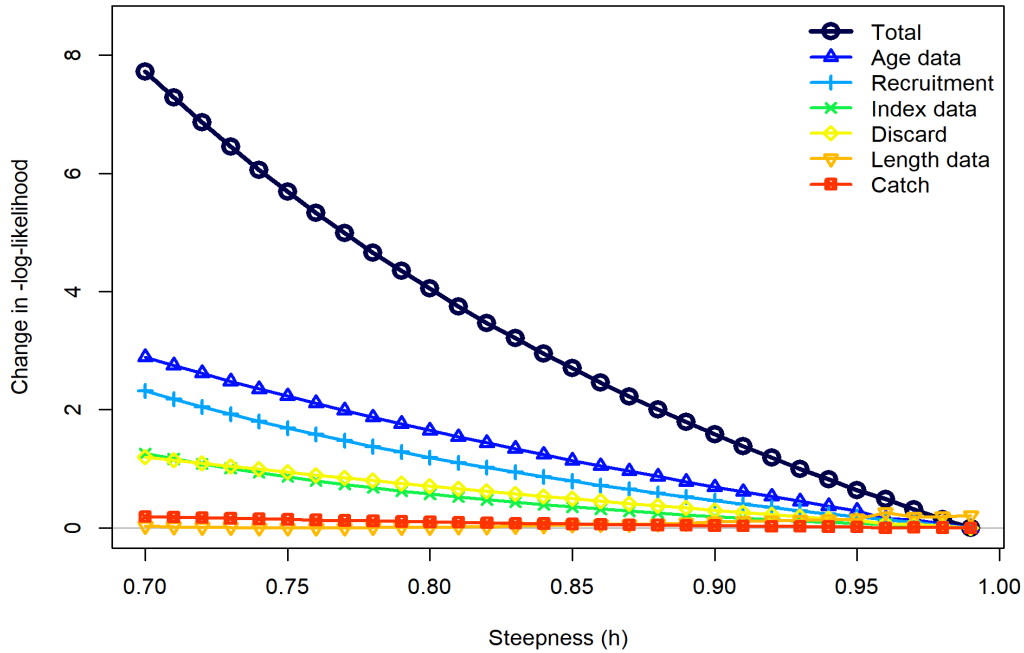

Figure RW39C. The profile likelihood for the steepness parameter of the Beverton – Holt stock-recruit function with no prior for Gulf of Mexico Scamp. Each line represents the change in negative log-likelihood value for each of the data sources fit in the model across the range of fixed values tested. Steepness was fixed at 0.6935 in the SEDAR 68 RW Base Model. Estimated steepness bounded out at 0.99 in the absence of a prior.

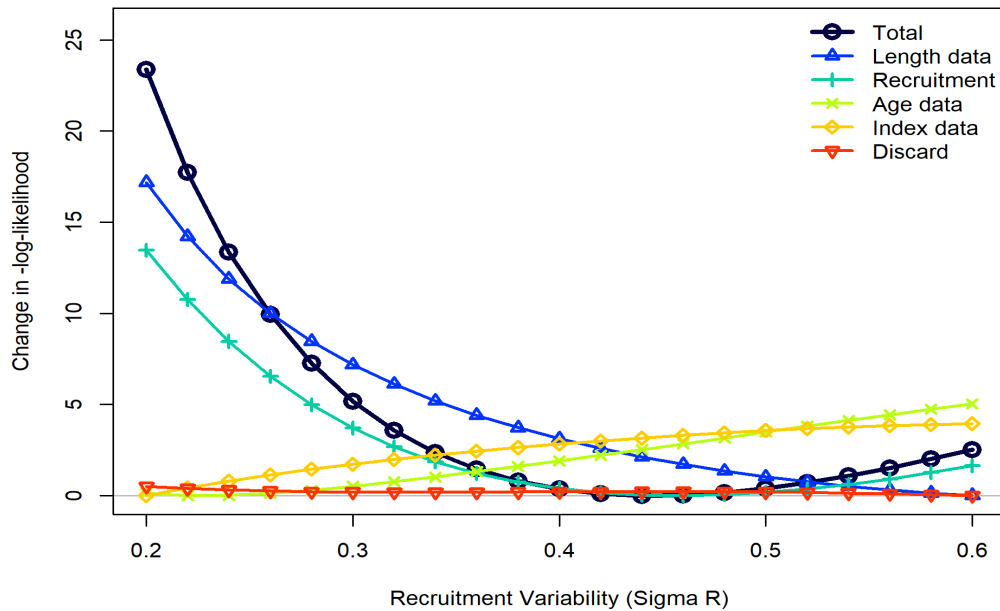

Figure RW39D. The profile likelihood for the recruitment variability (σR) parameter of the Beverton – Holt stock-recruit function for Gulf of Mexico Scamp. Each line represents the change in negative log-likelihood value for each of the data sources fit in the model across the range of fixed values tested. The MLE (CV) for the SEDAR 68 RW Base Model was 0.445 (0.128).

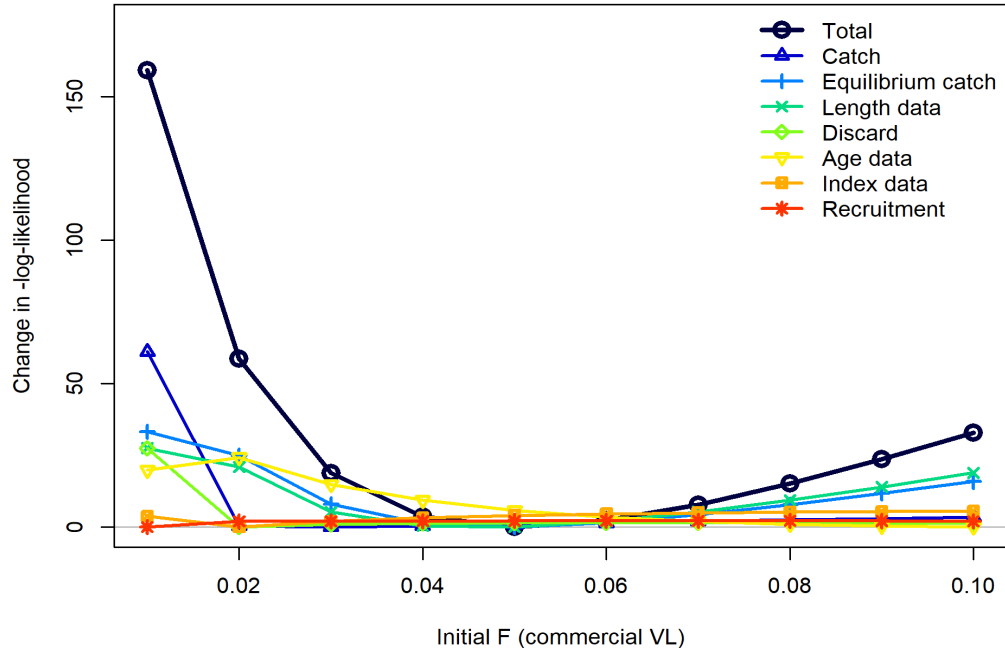

Figure RW39E. The profile likelihood for the initial fishing mortality rate for the Commercial Vertical Line fleet. Each line represents the change in negative log-likelihood value for each of the data sources fit in the model across the range of fixed values tested. The MLE (CV) for the SEDAR 68 RW Base Model was 0.05 (0.084).

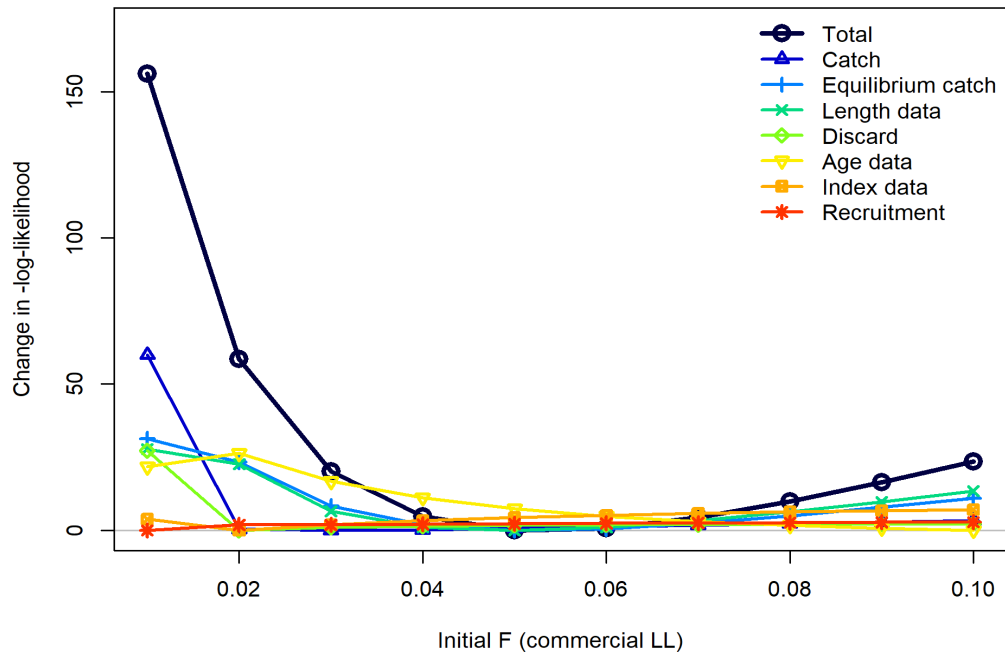

Figure RW39F. The profile likelihood for the initial fishing mortality rate for the Commercial Longline fleet. Each line represents the change in negative log-likelihood value for each of the data sources fit in the model across the range of fixed values tested. The MLE (CV) for the SEDAR 68 RW Base Model was 0.053 (0.09).

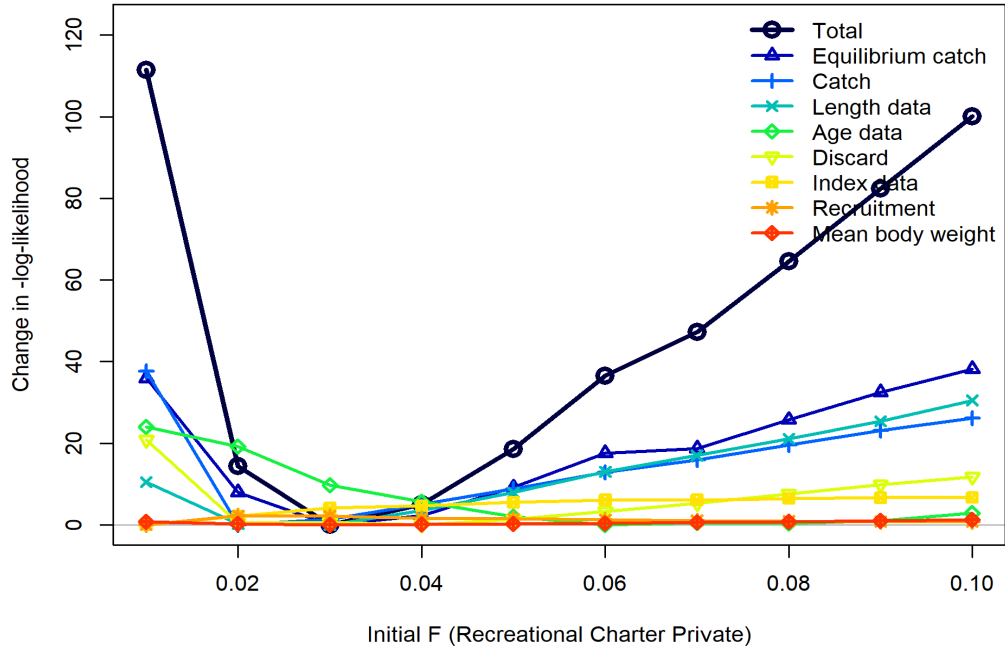

Figure RW39G. The profile likelihood for the initial fishing mortality rate for the Recreational Charter Private fleet. Each line represents the change in negative log-likelihood value for each of the data sources fit in the model across the range of fixed values tested in the profile diagnostic run. The MLE (CV) for the SEDAR 68 RW Base Model was 0.029 (0.072).

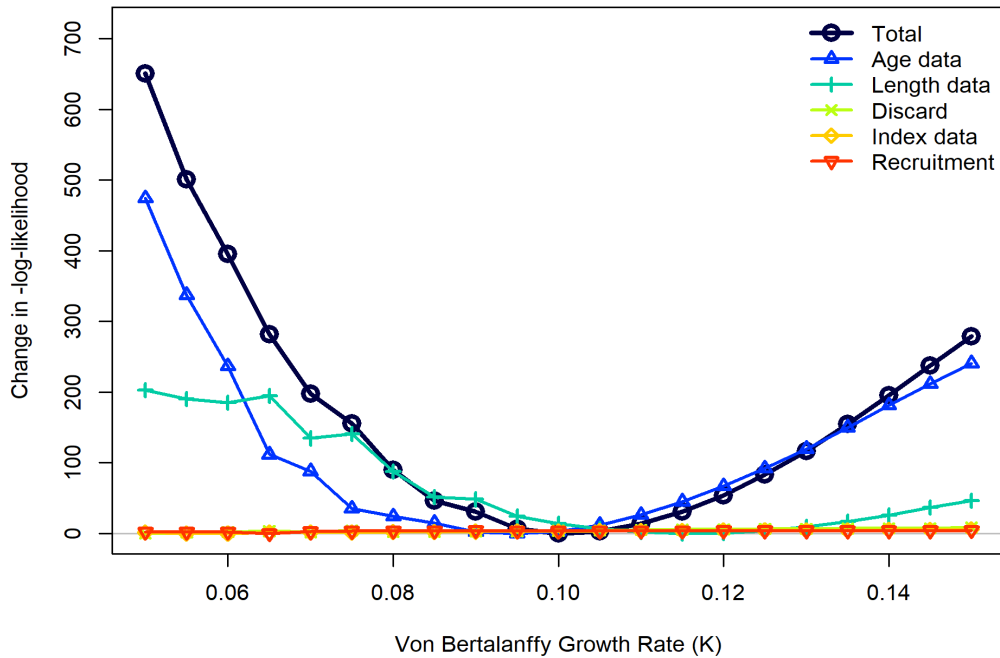

Figure RW39H. The profile likelihood for the von Bertalanffy growth rate parameter. Each line represents the change in negative log-likelihood value for each of the data sources fit in the model across the range of fixed values tested in the profile diagnostic run. This parameter was fixed at 0.134, which was recommended by the SEDAR 68 DW LHWG.

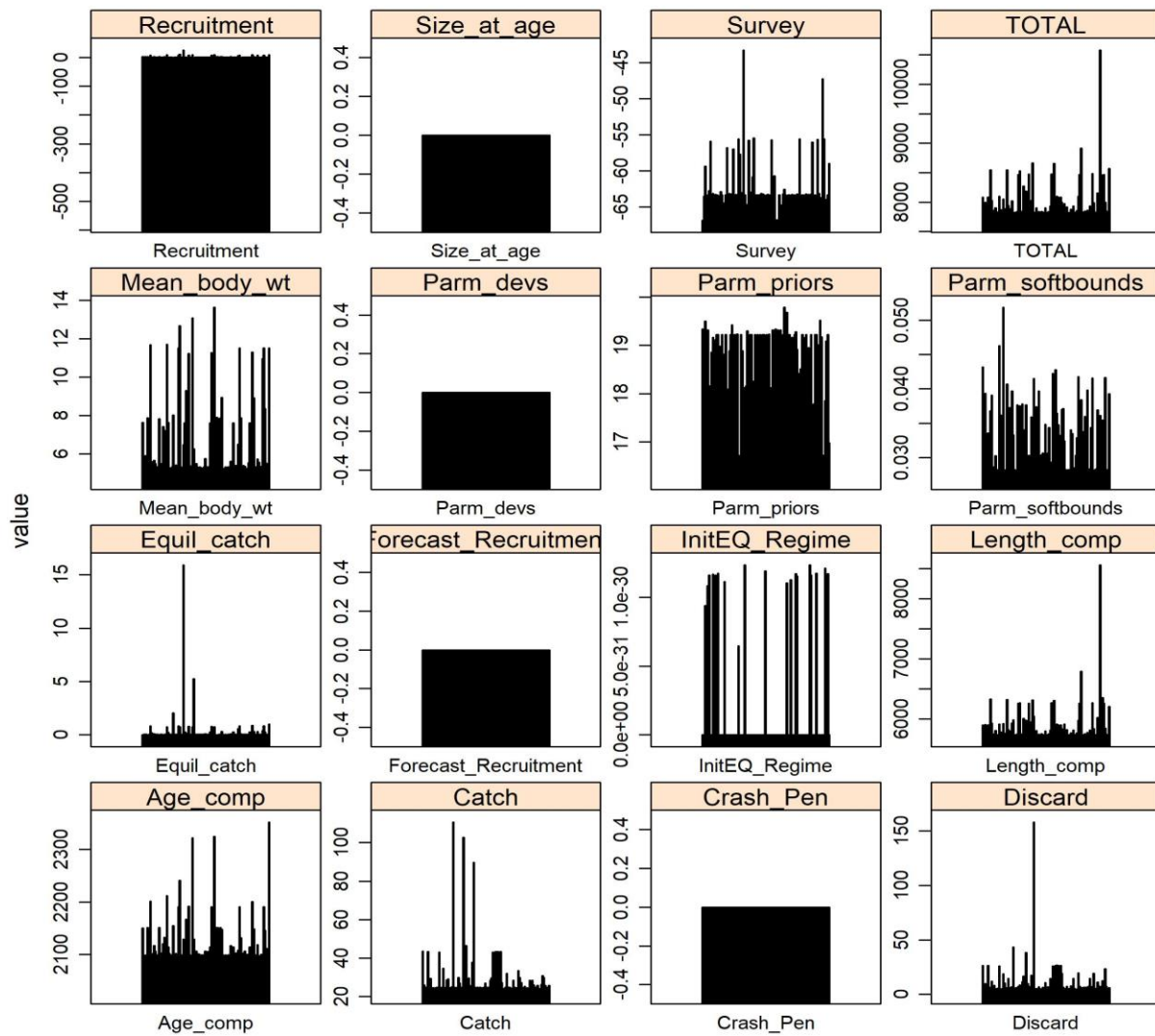

Figure RW40A. Results of the jitter analysis for various likelihood components for the SEDAR 68 RW Base Model for Gulf of Mexico Scamp. Each panel gives the results of 100 model runs where the starting parameter values for each run were randomly changed ('jittered') by 10% from the SEDAR 68 RW Base Model best fit values. Note that the y-axes differ between panels. Negative log-likelihood components shown from top left through bottom right include: recruitment, size-at-age, survey, total, mean body weight, parameter deviations (Parm_devs), parameter priors (Parm_priors), parameter softbounds (Parm_softbounds), initial equilibrium catch (Equil_catch), forecast recruitment, initial equilibrium regime (InitEQ_Regime), length composition (length_comp), age composition (age_comp), catch, crash penalty (Crash_Pen), and discards.

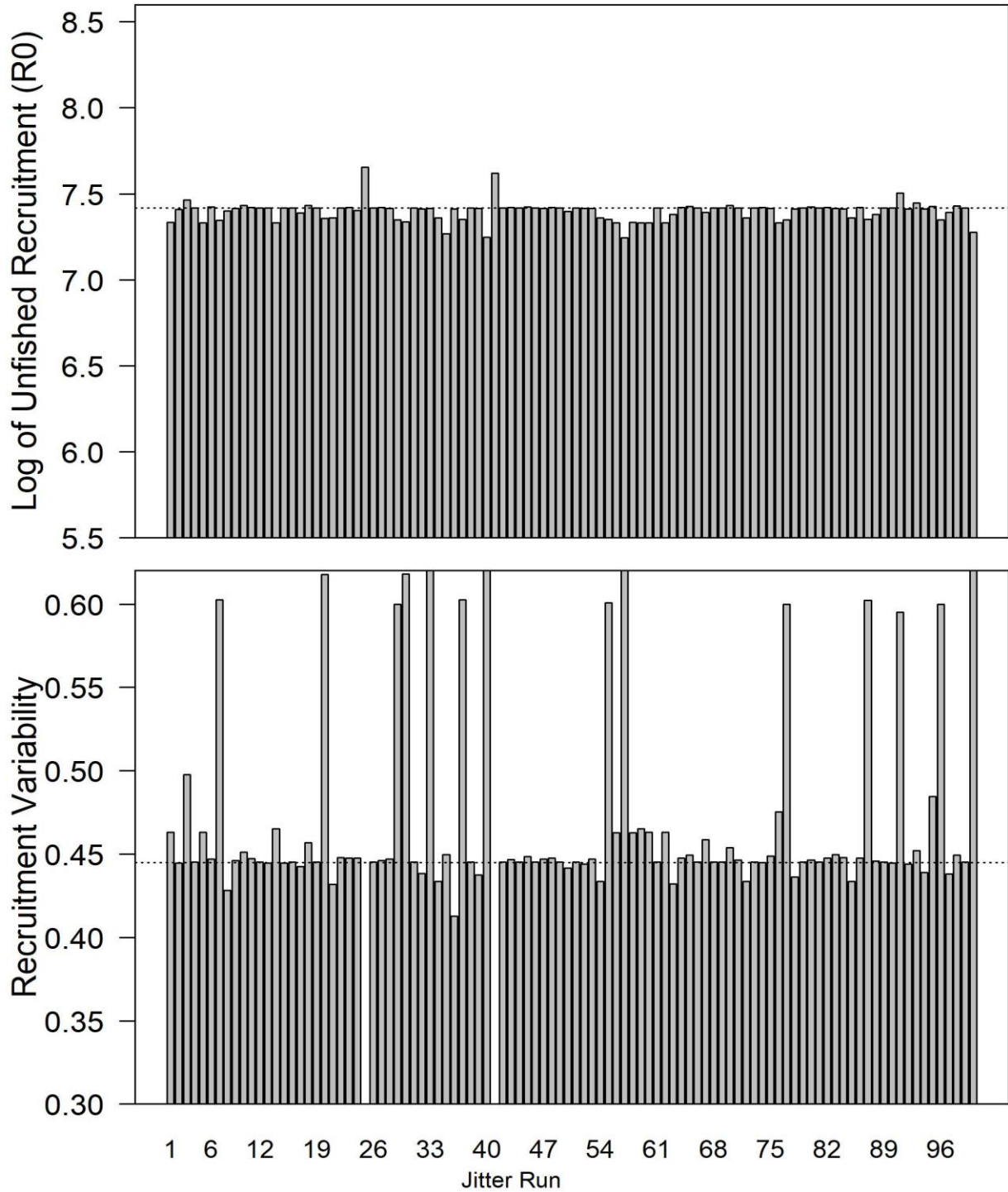

Figure RW40B. Results of the jitter analysis for the two key recruitment parameters for the SEDAR 68 RW Base Model for Gulf of Mexico Scamp. Each panel gives the model estimates for each parameter from 100 model runs where the starting parameter values for each run were randomly changed ('jittered') by 10% from the SEDAR 68 RW Base Model best fit values (shown in each panel by dashed horizontal lines).

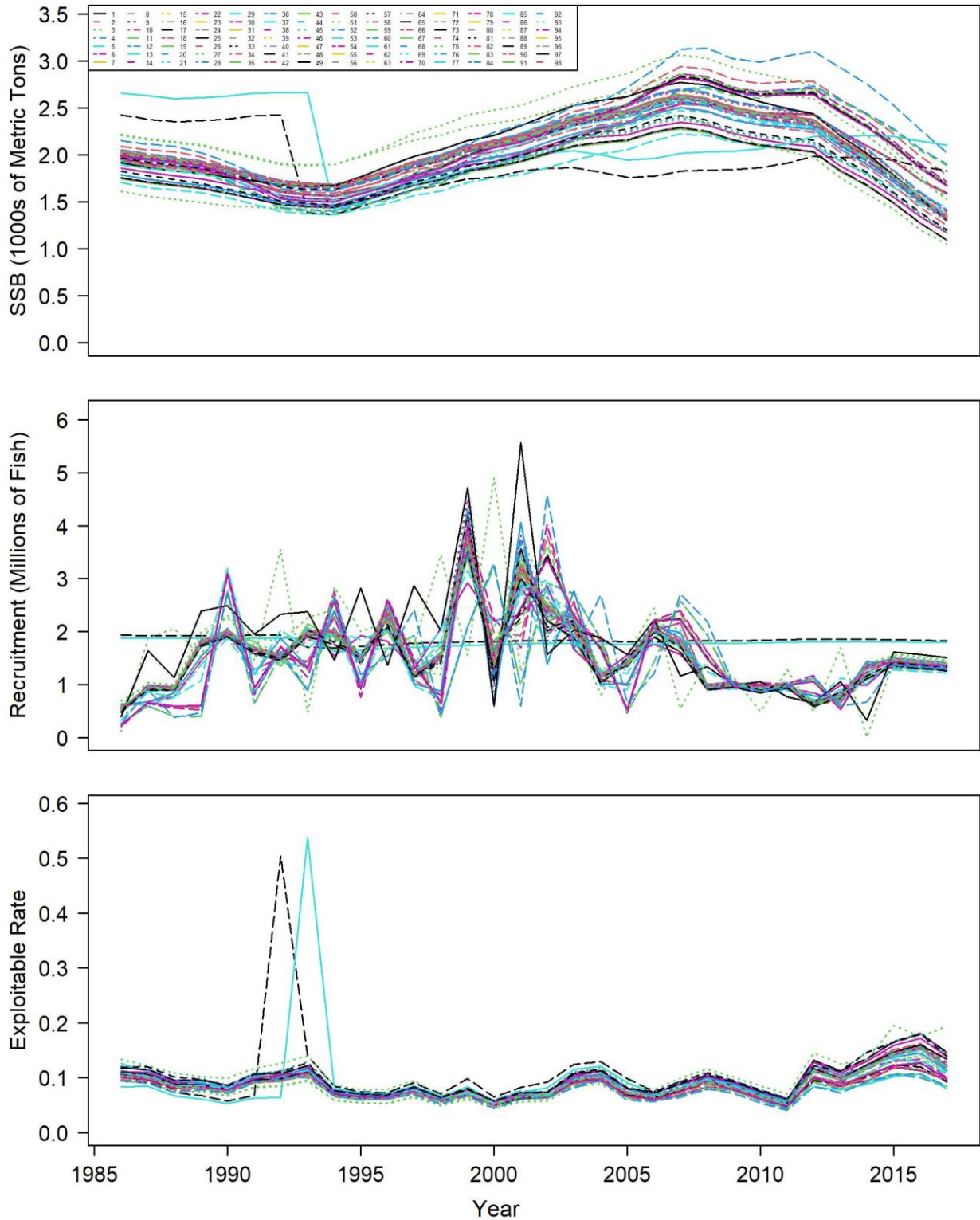

Figure RW40C. Estimated trajectories in spawning stock biomass (SSB, 1,000s of metric tons; top panel), recruitment (millions of fish; middle panel), and fishing mortality (total biomass killed age 3+ / total biomass age 3+; bottom panel) for the SEDAR 68 RW Base Model for Gulf of Mexico Scamp.

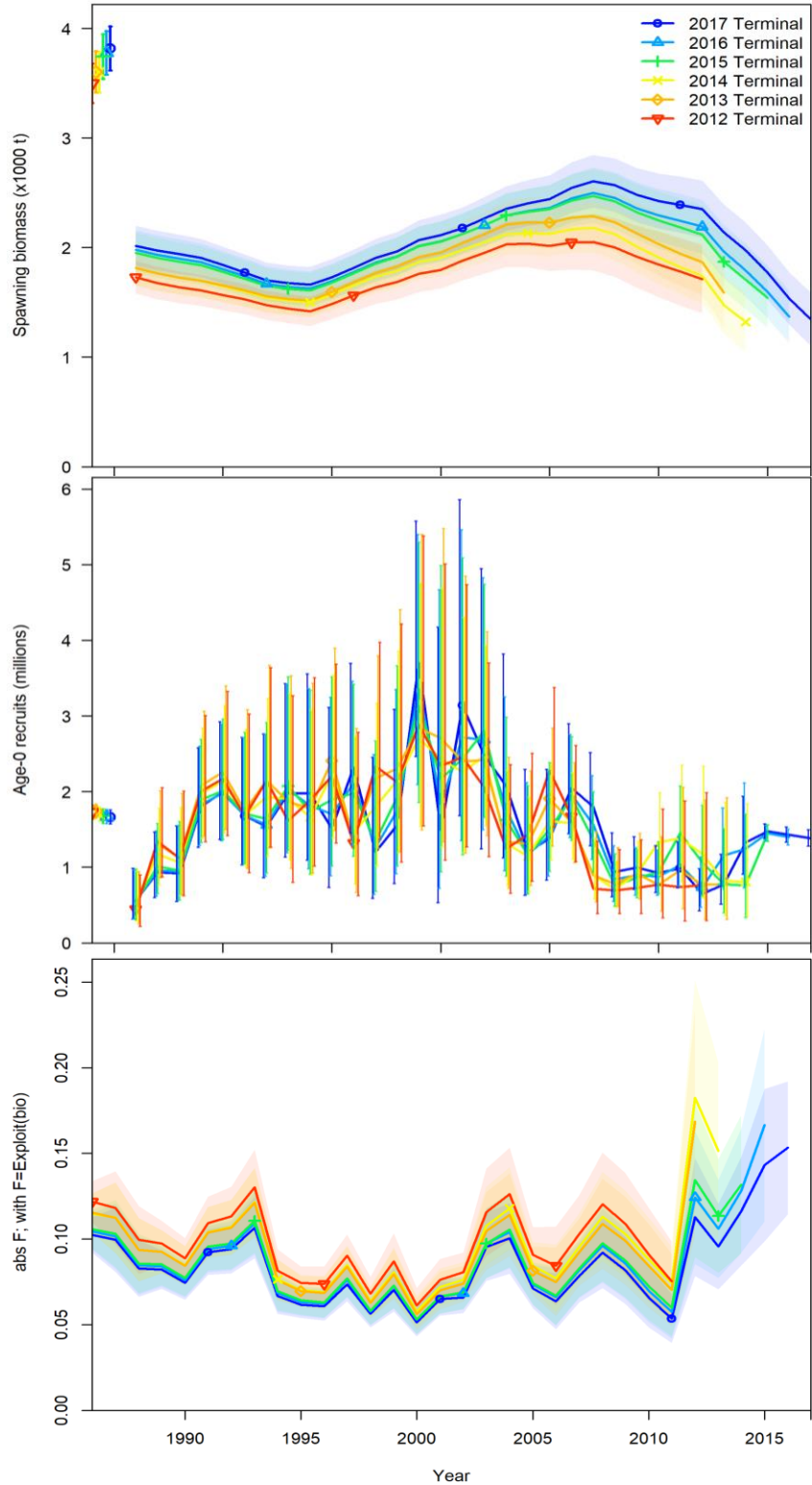

Figure RW41. Results of a five year retrospective analysis for spawning biomass (1,000s of metric tons; top panel), recruitment (millions of fish; middle panel), and fishing mortality (total biomass killed age 3+ / total biomass age 3+; bottom panel) for the SEDAR 68 RW Base Model for Gulf of Mexico Scamp.

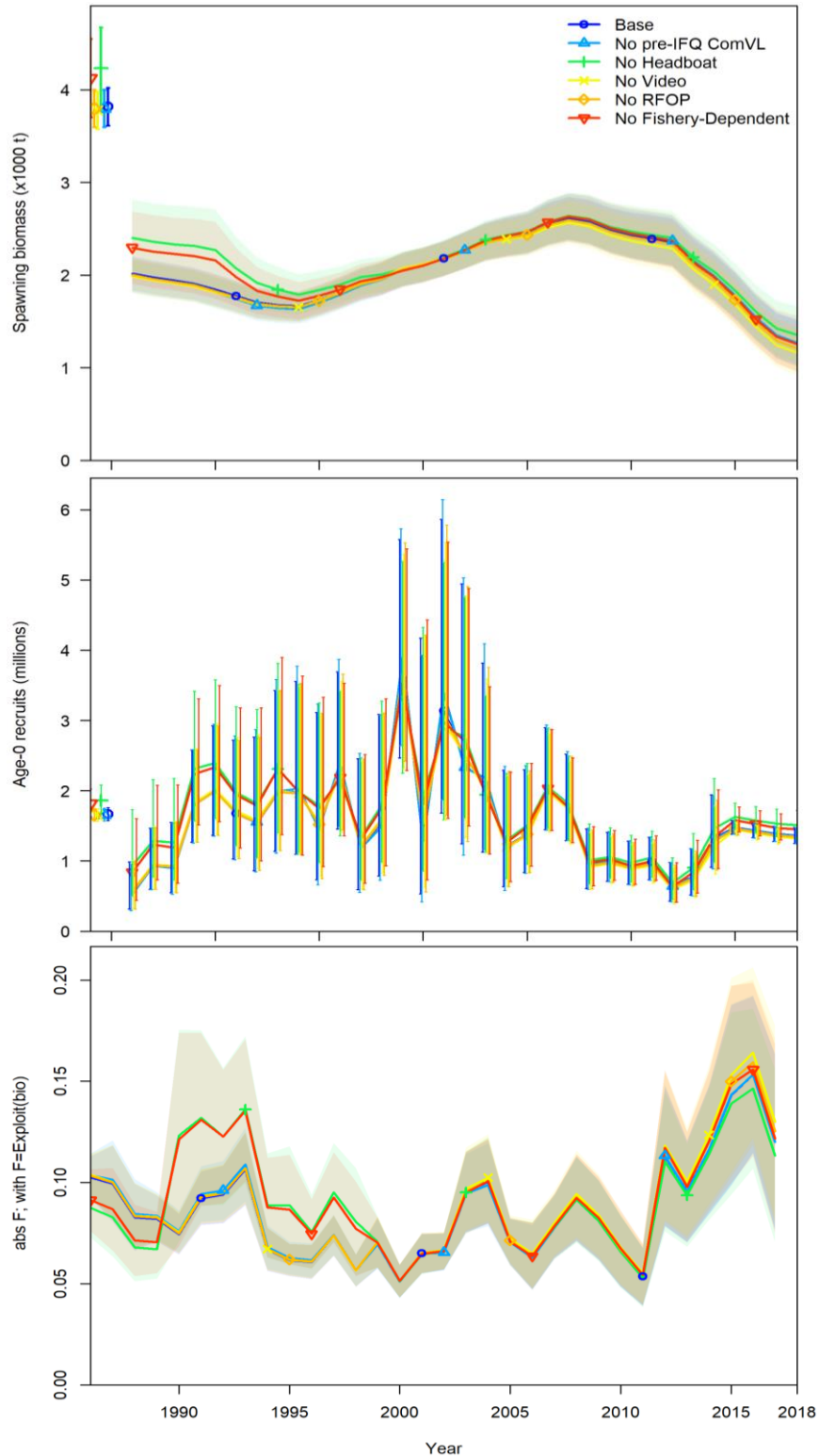

Figure RW42. Estimates of spawning stock biomass (1,000s of metric tons; top panel), recruitment (millions of fish; middle panel), and fishing mortality (total biomass killed age 3+ / total biomass age 3+; bottom panel) for the sensitivity runs removing each index of abundance for the SEDAR 68 RW Base Model for Gulf of Mexico Scamp.

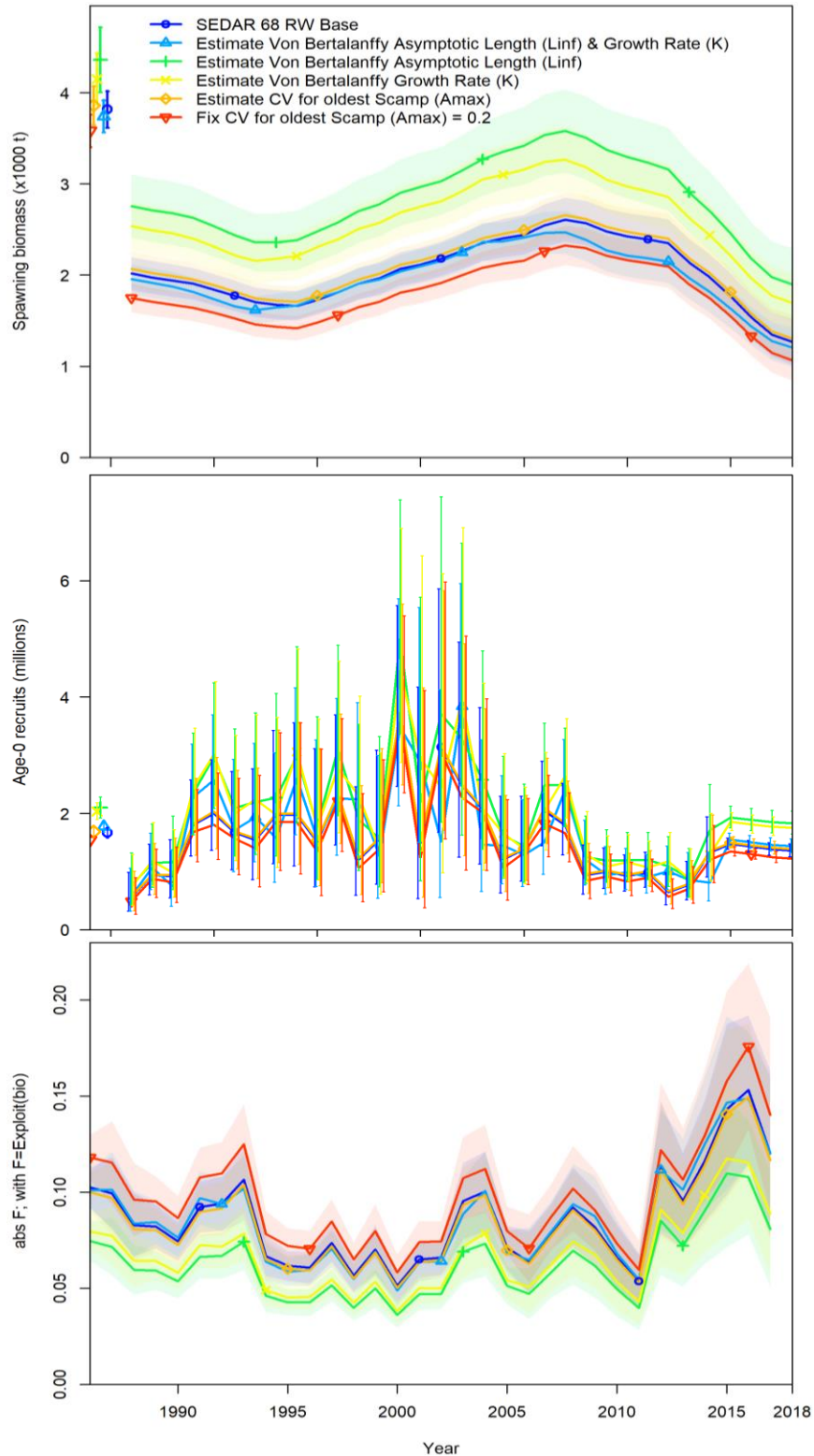

Figure RW46. Estimates of spawning stock biomass (1,000s of metric tons; top panel), recruitment (millions of fish; middle panel), and fishing mortality (total biomass killed age 3+ / total biomass age 3+; bottom panel) for the growth sensitivity runs conducted for the SEDAR 68 RW Base Model for Gulf of Mexico Scamp.